

DEEP DOWN DETECTIVES



Unit 16

**Simple Story Scenes, ESV
Jesus, the Returning King**



Curriculum for preschool and elementary age children,
training tools, music and other resources
are available for download or to order at:
www.praisefactory.org

© 2023 Praise Factory Media all rights reserved. May be reproduced by licensed user for classroom purposes only.

This and many other resources are available online at www.praisefactory.org

Scripture quotations marked (NIV) are taken from the Holy Bible, New International Version®, NIV®, Copyright © 1973, 1978, 1984 by Biblica, Inc.™ Used by permission of Zondervan. All rights reserved worldwide.www.zondervan.com

Scripture quotations marked (ESV) are from The Holy Bible, English Standard Version® (ESV®), copyright © 2001 by Crossway, a publishing ministry of Good News Publishers. Used by permission. All rights reserved.

Scripture quotations marked HCSB are taken from the Holman Christian Standard Bible®, Copyright © 1999, 2000, 2002, 2003, 2009 by Holman Bible Publishers. Used by permission. Holman Christian Standard Bible®, Holman CSB®, and HCSB® are federally registered trademarks of Holman Bible Publishers.

Table of Contents

About the Deep Down Detectives Visual Aids	5
Unit 16: Jesus, the Returning King	
What Will Happen When Jesus Comes Back? God Will Make Everything New!	
Bible Truth 1: Jesus Will Give Out Last and Fair Punishments for Sin	7
Bible Truth 1 Overview	9
Story Scenes	11
Bible Truth 2: God’s People Will Live Happily with God Forever	61
Bible Truth 2 Overview	63
Story Scenes	65
Take-Home Sheets	113
Bible Truth 1	115
Bible Truth 2	121

Deep Down Detectives Curriculum Resources

There are five companion resources for each of the sixteen units of Deep Down Detectives. Use whichever resources are useful to your setting. Deep Down Detectives resources are available as free, digital downloads at praisefactory.org, or for purchase as hard copies through amazon.com.

Make sure to check out the “Bits and Pieces” section of the Deep Down Detectives curriculum online. It has all of the resources separated out making it easy for you simply to pick, choose and print out whatever you want.

Deep Down Detectives Core Curriculum Book, ESV/NIV for each unit

The Deep Down Detectives Core Curriculum book contains the curriculum introduction, the lesson plans, stories, music, activities and take home sheets for each of the units.

Deep Down Detectives Visual Aids with Simple Story Scenes, ESV/NIV for each unit

This resource provides large, colorful signs of the key concepts used in the unit, PLUS, easy-to-use, colorful scenes that you hold up in sequence as you tell the story. The story text for each scene is printed on the bottom of each scene.

Deep Down Detectives Simple Story Scenes, ESV/NIV for each volume

This resource includes only 2-page overview for Bible Truth, the story scenes, and take home sheets. This is a great, basic resource for use at home and in many classroom teaching situations.

Deep Down Detectives Small Format Visual Aids, ESV/NIV (Small Format Storyboard Pictures) for each volume

This resource provides large, colorful signs of the key concepts used in the unit, PLUS, colorful storyboard (flannelgraph) pictures to cut out and use as you tell each story. These storyboard pictures are for use with storyboards at least 24" x 36" in size.

Deep Down Detectives Large Format Visual Aids, ESV/NIV (Large Format Storyboard Pictures) for each volume

This resource provides large, colorful signs of the key concepts used in the unit. It also provides colorful storyboard (flannelgraph) pictures to cut out and use as you tell each story. These storyboard pictures are for use with storyboards 36" x 48" in size.

All of these materials may be photocopied for non-commercial church, classroom or school use by licensed users.

Other Resources in the Praise Factory Family of Curriculum

Deep Down Detectives is the second in a family of three, inter-related curriculums:

- Hide 'n' Seek Kids (focus group: ages 2-4; adaptable range: ages 2-pre-K 5's)
- Deep Down Detectives (focus group: ages 4--6's; adaptable range: ages 3-2nd grade)
- PFI: (focus group: grades K-5th grade; adaptable range: pre-K 5's-6th grade)

Each curriculum teaches the same biblical themes, but are presented in greater depth as the children grow and develop. Together, the curriculums work like an expanding spiral of truth that returns to reinforce the same truths with each curriculum, yet leading the children to deeper understanding with each step up.

Learn more about these curriculums as well as other resources and ideas for reaching children with the gospel at: www.praisefactory.org.

Unit 16: Jesus, the Returning King

UNIT OVERVIEW

Jesus is coming back one day. What a day it will be! This old world and its ways will come to an end. God will destroy it and sin and death with it. He will create a new, perfect world for His people to live in with Him forever.

It will be a beautiful, happy place where there will never be anything sad or bad in it...ever! God's people will live there with Jesus as their king. Here on earth, they know God in their hearts; but there, they will see Him face-to-face. Think of your favorite thing to do. Life with Jesus will be better than this. Think of your favorite place to be. Life with Jesus in the new world will be better than that! Think of your favorite person to be with. Living with Jesus will be far better than that! There will never be anything better than living with God like this!

What a wonderful day that will be for God's people! What a wonderful day that will be for us, too, if we turn away from our sins and trust in Jesus as our Savior!

In this unit we will learn two truths about what will happen when Jesus comes back.

UNIT BIBLE VERSE: Revelation 21:5-6, ESV

"And he who was seated on the throne said, "Behold, I am making all things new...It is done! I am the Alpha and the Omega, the beginning and the end."

BIG QUESTION UNDER INVESTIGATION: What Will Happen When Jesus Comes Back?

ANSWER: God Will Make Everything New!

OPTIONAL Big Question 16 INTRODUCTION LESSON (Use Hide 'n' Seek Kids Unit 16 Material)

Story: The Case of the Wonderful Ending 2 Peter 3

Bible Verse: Revelation 21:5-6, ESV

BIBLE TRUTH 1: Jesus Will Judge All People Fairly (3 Lessons Available)

Story: The Case of the Two, Big Books Matthew 16; Mark 8:27-38, Revelation 20:11-15

Bible Verse: Revelation 22:12-13, ESV

BIBLE TRUTH 2: God's People Will Live Happily with God Forever (3 Lessons Available)

Story: The Case of the Promise Keeper Isaiah 1,2,6,24,25,49,52-53,60,65,66; Daniel 3; Revelation 21

Bible Verse: Revelation 19:6-7, ESV

Deep Down Detectives ESV Songs 16 Track Numbers

This is a listing of all songs mentioned in the unit curriculum. You may or may not choose to use all of the songs. They are listed in easy-reference order--NOT in the order used in the curriculum.

You may choose to simply burn a CD/load them onto an mp3 device in this order. Or, you may want to do what we do: choose the songs we want to use and create a play list of them in that order. Then, we burn a CD/upload the play list onto an mp3 device. A teacher only has to click forward to the next song, instead of hunting for the right track. The track number have been included as part of the title of each song, teachers will still have a reference to the track number listed in the curriculum (same as those listed below), even if you change the order on your customized play list.

listen to or download songs for free at <https://praisefactory.org:Deep Down Detectives Music page>

SONGS USED EVERY UNIT OF THE CURRICULUM

- 1 The Classroom Song v.1
- 2 The Classroom Song v.2
- 3 The Classroom Song v.3
- 4 The Classroom Song v.4
- 5 Deep Down Detectives Theme Song
- 6 The Classroom Rules Song
- 7 Let's Pray Song
- 8 The Big Question Box Song
- 9 The Bible Chant Song
- 10 ACTS Prayer Song (Short Version)
- 11 ACTS Prayer Song (Full Version)

Why the Extra Songs?

Deep Down Detectives is a curriculum used by a wide age-span of kids. Sometimes one of the other songs is a better fit for your kids. Or, you may simply want to teach them more songs on the same Bible Truth. Use as many or as few as you want.

UNIT 16: JESUS, THE RETURNING KING

- 12 Big Q & A 16 Song
- 13 Big Question 16 Song: What Will Happen When Jesus Comes Back?
- 14 Big Question 16 Bible Verse Song: And He Who Was Seated Revelation 21:5-6, ESV
- 15 *Extra Big Question 16 Bible Verse Song: I Am Making All Things New Revelation 21:5, NIV 1984 (other version)*
- 16 Big Question 16 Hymn: At the Name of Jesus, v.1
- 17 Big Question 16 Praise Song: He Is Lord

What Will Happen When Jesus Comes Back?

God Will Make Everything New...

Bible Truth 1: Jesus Will Judge All People Fairly

- 18 Bible Verse: Behold, Behold Revelation 22:12-13, ESV
- 19 *Extra Bible Verse: Henceforth There Is 2 Timothy 4:8, ESV*
- 20 *Extra Bible Verse: The Day of the Lord 2 Peter 3:10-13, ESV*
- 21 *Extra Bible Verse: When You Hear of Wars Mark 13:7-10,26,27, ESV*
- 22 *Extra Bible Verse: God Is Just 2 Thessalonians 1:6-10, NIV 1984*

Bible Truth 2: God's People Will Live Happily with God Forever

- 23 Bible Verse: Hallelujah, Hallelujah! Revelation 19:6-7, ESV
- 24 *Extra Bible Verse: Hallelujah! Revelation 19:6-7, ESV*
- 25 *Extra Bible Verse: We'll All Be Changed 1 Corinthians 15:51,52,54, ESV*
- 26 *Extra Bible Verse: Behold a Great Multitude Revelation 7:9-10, ESV*
- 27 *Extra Bible Verse: No More Death Revelation 21:3-4;22:3-8, ESV*

DEEP DOWN DETECTIVES



Simple Story Scenes

Unit 16,

Bible Truth 1

Using Simple Story Scenes as a Curriculum

Introduce the Key Concept and Bible Verse

Simple Story Scenes give you the basics for the core of your lesson. You can use the overview sheet to introduce and explain the key concept and Bible verse.

Give the Case Assignment

Give the children a Detective Dan listening assignment. Two are provided. You can add a third using the ideas on the bonus, third take-home sheet, if desired. Each listening assignment, let's you teach the story with a different learning emphasis.

Show & Tell the Story

Hold up the pictures and tell the story from the story scenes. Alternatively, you can find in the and Pieces section for this unit at praisefactory.org, these same listening assignments and story scenes, gospel and ACTS prayer modified for view on a screen. Simply download them or open them online and show through your own monitor (tablet, big screen, whatever).

Solve the Case

Repeat Detective Dan's listening assignment question and discuss the answer.

Share the Gospel

Share the gospel tie-in with the kids.

Close in ACTS Prayer

Pray the ACTS prayer with the kids. If using the curriculum with older children, give them a chance to think up their own ACTS tie-ins to the story, using the one provided as cues/ideas for you.

Review Time

Give out the take-home sheet (there are three: two that correlates to the two Detective Dan assignments in the Story Scenes, and a bonus third one.) As the children are coloring, use the take-home sheet discussion questions or your own questions to further review and apply the key concepts, Bible verse, and story truths to the children.

Looking for more?

Online, in the Bits and Pieces section for this unit, you will find review games, crafts, storyboard flannelgraph figures, and audio and sheet music for all of the songs. There are also full lesson plans that offer more of a script and take this curriculum's possibilities to much more depth. Don't forget to tell the parents about the Parents Resources section where they can read through the Story scenes and download take homes with their kids.

Unit 16: Jesus, the Returning King

Unit Big Question (and Answer): What Will Happen When Jesus Comes Back?
God Will Make Everything New!

Unit Bible Verse: "And he who was seated on the throne said, "Behold, I am making all things new... It is done! I am the Alpha and the Omega, the beginning and the end."--Revelation 21:5-6, ESV

Bible Truth 1 Concept: God Will Make Everything New.. Jesus Will Judge All People Fairly!

When Jesus comes back, He will gather everyone who has ever lived before Him to be judged fairly. All the people who are alive when Jesus comes back, will stand before Him. All the people who were already dead will come out of the places they are buried and appeared before Him, too. Millions and millions, billions and billions of people.

There will be more people than WE can know or count standing before Jesus on that day. But they won't be too many for Jesus. Jesus is God's Son. He knows everyone completely. Nothing is hidden from Him. And on that day, Jesus will sit on His throne (king's chair) and will judge all of us. What does it mean to judge? It means that Jesus will think fairly about what each person did with the life God gave them. Did they love God and serve Him? Did they love others? How did they use the good gifts God gave them? And most importantly, did they turn away from their sins and trust in Jesus as their Savior... or, did they refuse Him?

It will be the saddest of days for all who refused to turn away from their sins and trust in Jesus as their Savior. The day for forgiveness and mercy will be over. Now, they will be separated from God and everything good forever. Satan and all the angels who rebelled against God will receive this final, terrible punishment, too. Oh, how I wish that everyone would turn away from their sins and trust in Jesus instead of receiving God's punishment!

But what about God's people? How will Jesus fairly think about them? Didn't they disobey God, too? Shouldn't they be separated from God, too? Yes, they did disobey God, too. Yes, they deserve to be separated from God; but instead, they will receive wonderful, eternal life with God on that day! Why? Because they turned away from their sins and asked for God's forgiveness. They trusted in Jesus as their Savior, and He paid for their sins when He died on the cross. Because of Jesus, this will be a day of praise for them. Jesus will reward them for the good works they did in His name. And best of all, they will get to live happily with God in special closeness forever. We can be ready for that day, too, if we turn away from our sins and trust in Jesus as our Savior. This is how we become God's people.

Bible Truth 1 Bible Verse: Revelation 22:12-13, ESV

"Behold, I am coming soon, bringing my recompense with me, to repay each one for what he has done. I am the Alpha and the Omega, the first and the last, the beginning and the end."

Learn a Little: "I am coming soon to repay each one for what he has done."

Meaning

One day, Jesus will come back. He will bring an end to sin and death. He will fairly judge everyone. Oh, what an awful day it will be for those who did not turn away from their sins and trust in Jesus! There will be no good reward for them. Only God's punishment for their sins. How sad!

But the day Jesus comes back will be a wonderful day of celebration for God's people! He will reward the good things that God did through them. And because they did turn away from their sins and trusted in Him as their Savior, they will go to live with Him forever in the new heaven and earth He will create for them. We will be there on that day, too. It can be a day of celebration for us, too, if we turn away from our sins and trust in Jesus as our Savior.

Bible Truth 1 ACTS Prayer

- A** We praise You, Jesus, for being the good Judge who will give out fair rewards and punishments to all people at the end of time. We praise You for being the Savior who offers to forgive us and make us God's people, so we can live with You and celebrate on that day You judge us all.
- C** Jesus, we know that we are all sinners. We have all disobeyed God's laws. We can never deserve to be God's people on our own. We need You to be our Savior!
- T** Thank You, Jesus, that we do not have to depend on our own goodness on the day You judge us. Thank You for dying on the cross to save all who turn away from their sins and trust in You as their Savior. Thank You that You will judge all who do according to Your perfect life, not their own. You have taken God's punishment in their place. They are forgiven. If we trust in You, we don't have to fear Your punishment on that day. We can look forward in excitement to life with You forever.
- S** Work in our hearts! Help us all to turn away from our sins and trust in You as our Savior. Help us to do good things with the gifts You have given us. Help us to love You and love others. Come back soon, Jesus!

In Jesus' name we pray, Amen.

Bible Truth 1 Story**The Case of the Two, Big Books**

Matthew 16; Mark 8:27-38, Revelation 20:11-15

Songs Used in Bible Truth 1

Big Q & A 16 Song

Big Question 16 Song: What Will Happen When Jesus Comes Back?

Big Question 16 Bible Verse Song: And He Who Was Seated Revelation 21:5-6, ESV

Extra Big Question 16 Bible Verse Song: I Am Making All Things New Revelation 21:5, NIV 1984

Big Question 16 Hymn: At the Name of Jesus, v.1

Big Question 16 Praise Song: He Is Lord

Bible Truth 1 Bible Verse Song: Behold, Behold Revelation 22:12-13, ESV

Bible Truth 1 Extra Bible Verse: Henceforth There Is 2 Timothy 4:8, ESV

Bible Truth 1 Extra Bible Verse: The Day of the Lord 2 Peter 3:10-13, ESV

Bible Truth 1 Extra Bible Verse: When You Hear of Wars Mark 13:7-10,26,27, ESV

Bible Truth 1 Extra Bible Verse: God Is Just 2 Thessalonians 1:6-10, NIV 1984

listen to or download songs for free at <https://praisefactory.org>: Deep Down Detectives Music page

“The Case of the Two, Big Books” Matthew 16; Mark 8:27-38, Revelation 20:11-15



Detective Dan's Listening Assignment #1

1. Who will come back at the end of time?
2. What are the two, big books? What will He do with the two, big books?



Detective Dan's Listening Assignment #2

Revelation 22:12, ESV

“Behold, I am coming soon, bringing my recompense with me, to repay each one for what he has done.”

1. Who is coming back?
2. What will He do He comes back?

(more listening and discussion questions are included in the curriculum at praisefactory.org)

I. “Who is this Jesus?” people wondered. “He talks about God like no teacher we’ve ever heard! He heals sick people with just His word! He raises the dead people back to life!

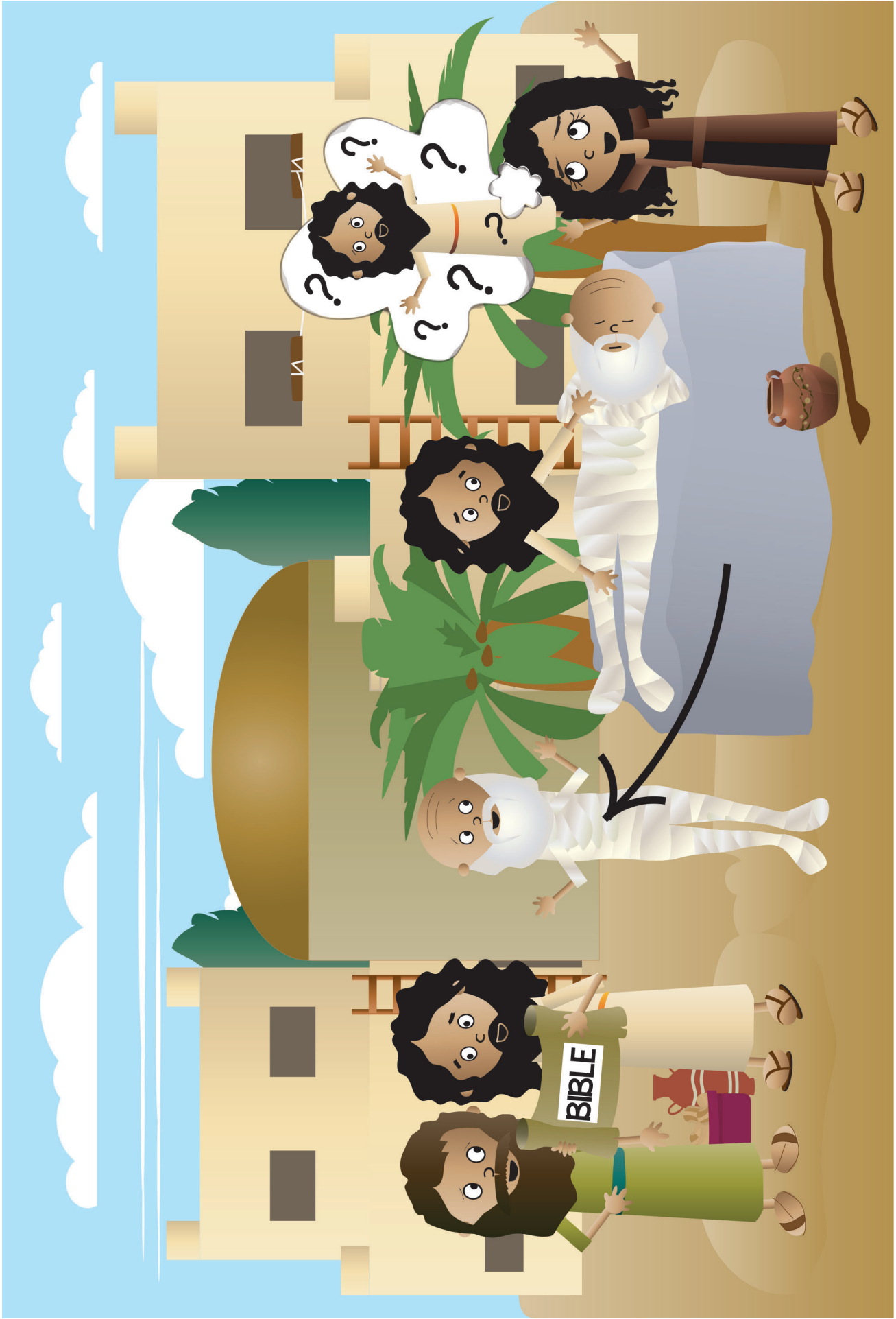

1. "Who is this Jesus?" people wondered. "He talks about God like no teacher we've ever heard! He heals sick people with just His word! He raises the dead people back to life!"

2. “He prays, and little pieces of fish and bread become enough to feed huge crowds of people! We’ve never seen anyone do such amazing things by God’s power. Who is this Jesus?” they asked.

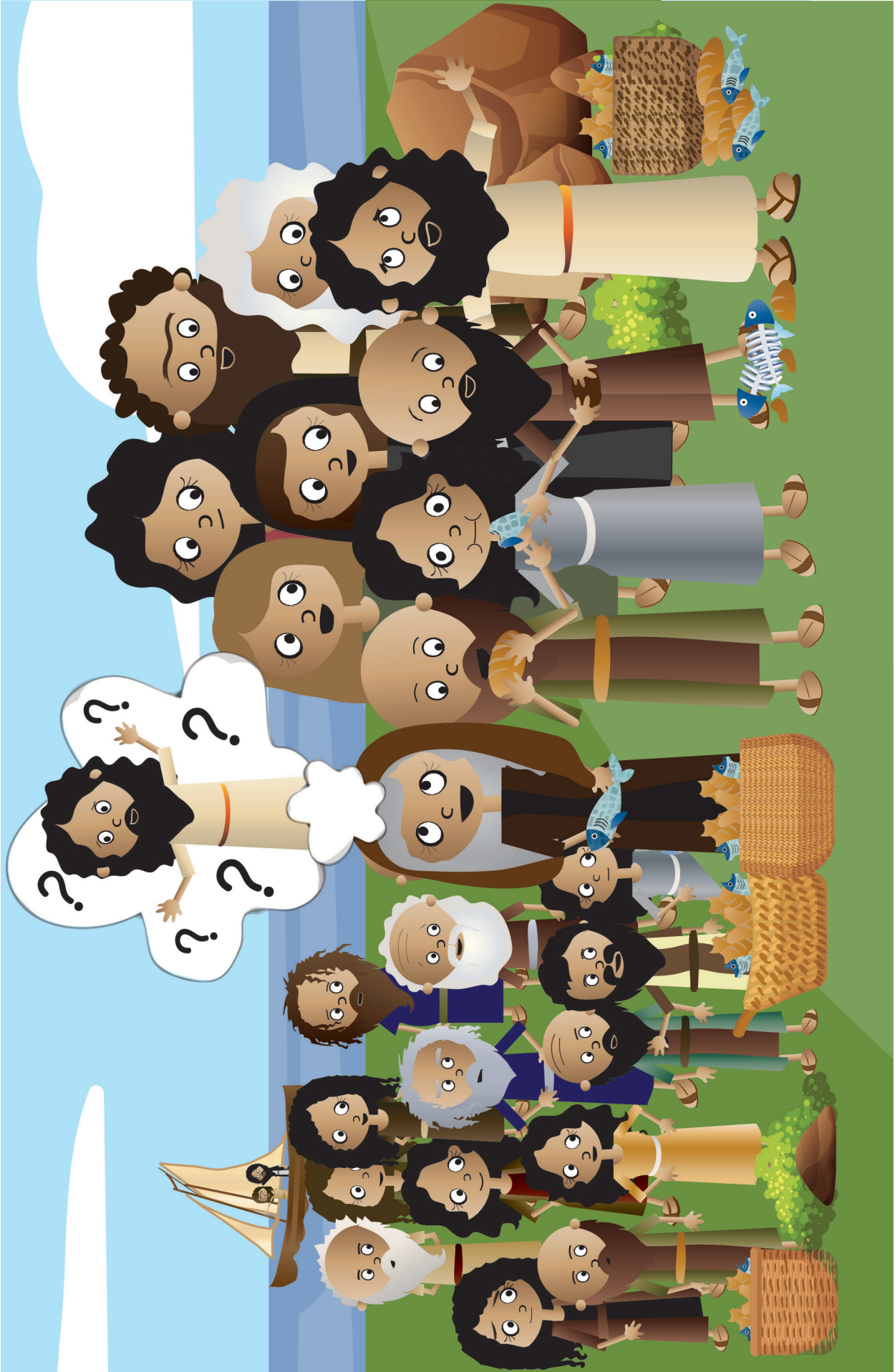

2. "He prays, and little pieces of fish and bread become enough to feed huge crowds of people! We've never seen anyone do such amazing things by God's power. Who is this Jesus?" they asked.

3. “He’s John the Baptist come back to life,” some people answered.

John the Baptist was a godly man who preached about God but had been captured and killed by King Herod. These people believed God had brought John back to life as Jesus. Was THAT who Jesus was?

Jesus WAS a godly man. He DID preach about God. But, no. He wasn’t John come back to life. Jesus was His own person, and He was Someone far greater than John.



3. "He's John the Baptist come back to life," some people answered. John the Baptist was a godly man who preached about God but had been captured and killed by King Herod. These people believed God had brought John back to life as Jesus. Was THAT who Jesus was? Jesus WAS a godly man. He DID preach about God. But, no. He wasn't John come back to life. Jesus was His own person, and He was Someone far greater than John.

4. “Jesus is a great prophet, like Elijah, from the old days,” other people said.

Prophets were people God sent to tell the people of Israel how to obey Him. Was THAT who Jesus was? Jesus HAD been sent by God. And like the prophets, Jesus DID tell the people how to obey God.

But, no! That’s not who Jesus was either. He was Someone far greater than just a prophet.



4. “Jesus is a great prophet, like Elijah, from the old days,” other people said. Prophets were people God sent to tell the people of Israel how to obey Him. Was THAT who Jesus was? Jesus HAD been sent by God. And like the prophets, Jesus DID tell the people how to obey God. But, no! That’s not who Jesus was either. He was Someone far greater than just a prophet.

5. Well, if He wasn't John come back to life, or a prophet, just like in the old days, then who WAS Jesus? It was time for Jesus to ask His twelve, close followers, the disciples.

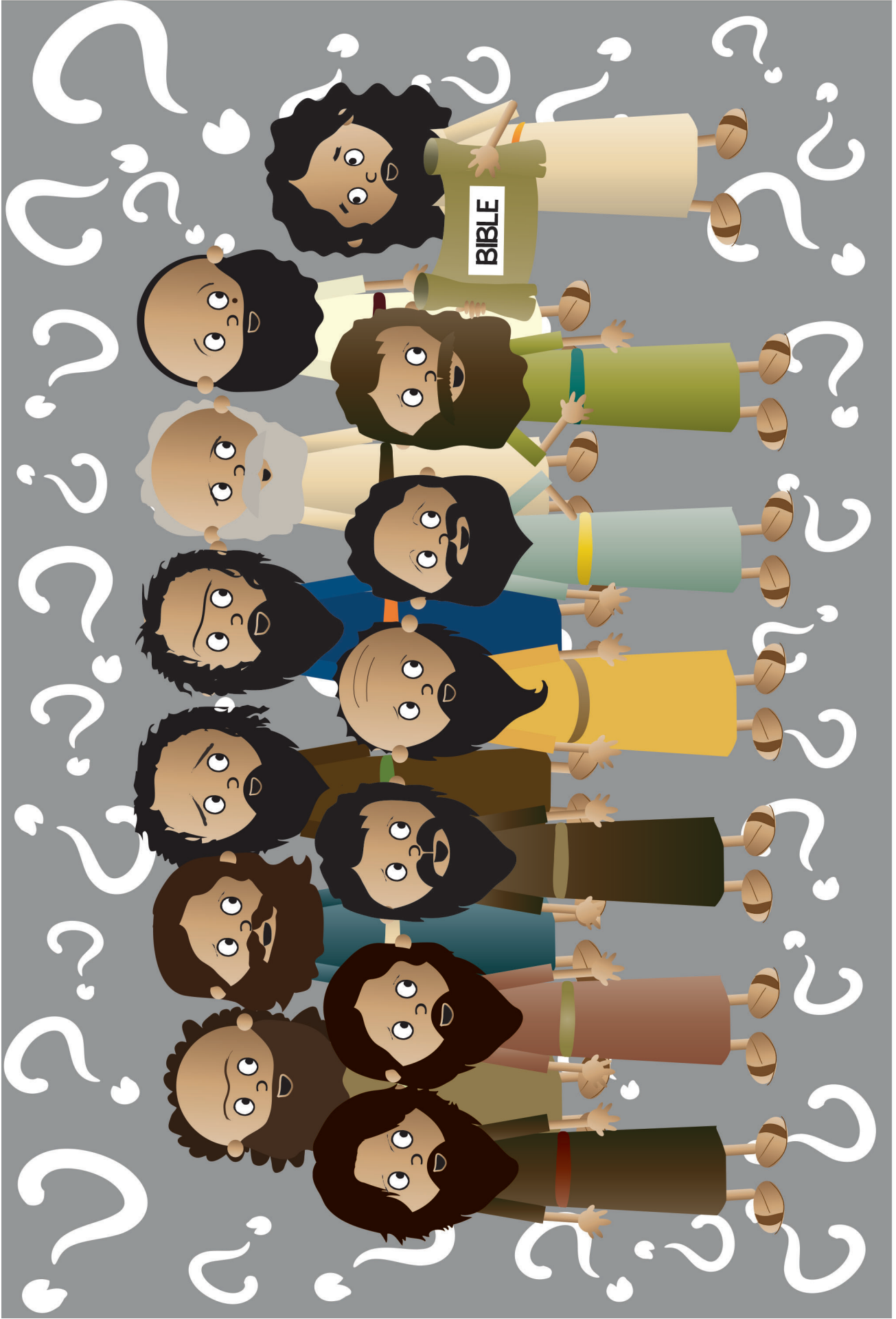

5. Well, if He wasn't John come back to life, or a prophet, just like in the old days, then who WAS Jesus? It was time for Jesus to ask His twelve, close followers, the disciples.

6. For three years, Jesus had been showing and telling who He was with the marvelous things He did and said. Now, it was almost time for Him to die.

So, Jesus took His disciples up to Caesarea Philippi, the greatest worship place of fake gods in Israel, to a temple-cave called the “The Gates of Hell.” He had something very important to talk to them about.



6. For three years, Jesus had been showing and telling who He was with the marvelous things He did and said. Now, it was almost time for Him to die. So, Jesus took His disciples up to Caesarea Philippi, the greatest worship place of fake gods in Israel, to a temple-cave called the "The Gates of Hell." He had something very important to talk to them about.

7. As they neared that temple-cave, where God's enemy, Satan, seemed so strong, Jesus used a question to make it clear to His disciples the REAL answer about Himself. And, He would help them understand what that answer meant for His life and theirs. So, Jesus turned to His disciples, and asked, "Who do YOU say that I am?"



7. As they neared that temple-cave, where God's enemy, Satan, seemed so strong, Jesus used a question to make it clear to His disciples the REAL answer about Himself. And, He would help them understand what that answer meant for His life and theirs. So, Jesus turned to His disciples, and asked, "Who do YOU say that I am?"

8. Peter spoke up right away: “You are the Messiah, the Christ, the Son of the living God, sent to save us.”

Peter believed Jesus was the great Forever King God promised to send. This king was to rule the world God’s way and get rid of God’s enemies --those who do not want Him to be king and will not turn from disobeying Him.

Was THAT who Jesus was? Did Peter have it right?



8. Peter spoke up right away: "You are the Messiah, the Christ, the Son of the living God, sent to save us." Peter believed Jesus was the great Forever King God promised to send. This king was to rule the world God's way and get rid of God's enemies --those who do not want Him to be king and will not turn from disobeying Him. Was THAT who Jesus was? Did Peter have it right?

q. “You are right, Peter. I am the Messiah, the Christ, God’s Forever King,” Jesus replied.

“God, My Father, has given you this faith to know who I am and believe in Me. And Your faith is just the beginning. God will give this faith to many, and they will become God’s people, the Church. And not even God’s enemy, Satan, or the “Gates of Hell” will defeat it,” Jesus said.



q. "You are right, Peter. I am the Messiah, the Christ, God's Forever King," Jesus replied. "God, My Father, has given you this faith to know who I am and believe in Me. And Your faith is just the beginning. God will give this faith to many, and they will become God's people, the Church. And not even God's enemy, Satan, or the "Gates of Hell" will defeat it," Jesus said.

10. Jesus was stronger than even the strongest enemy. He was why His Church would endure. He would beat sin and death AND Satan for them!



10. Jesus was stronger than even the strongest enemy. He was why His Church would endure. He would beat sin and death AND Satan for them!

II. “But shhh, don’t tell anyone who I am just yet,” Jesus told His disciples. “Before I rule as king, I must be taken by My enemies to suffer and die on the cross. And on the third day, I will be raised from the dead,” Jesus explained.



11. "But shhh, don't tell anyone who I am just yet," Jesus told His disciples. "Before I rule as king, I must be taken by My enemies to suffer and die on the cross. And on the third day, I will be raised from the dead," Jesus explained.

12. Peter didn't like what Jesus said. "No, Lord. This will not happen to You!" Peter scolded.

Peter was sure Jesus had it wrong. Enemies weren't supposed to hurt God's Forever King! No! HE was supposed get rid of God's enemies! HE was supposed to bring an end to sin! HE was supposed to be worshiped by all! The great, Forever King shouldn't suffer and die! He should live Forever! Jesus had it WRONG!



12. Peter didn't like what Jesus said. "No, Lord. This will not happen to You!" Peter scolded. Peter was sure Jesus had it wrong. Enemies weren't supposed to hurt God's Forever King! No! HE was supposed get rid of God's enemies! HE was supposed to bring an end to sin! HE was supposed to be worshiped by all! The great, Forever King shouldn't suffer and die! He should live Forever! Jesus had it **WRONG!**

13. But it was Peter who was wrong. “Stop saying this, Peter!” Jesus replied. “You might think you’re trying to protect me, but you’re talking like Satan, God’s great enemy. You are tempting me to disobey God’s good plan,” Jesus told Peter. “I MUST suffer and die on the cross to save God’s people,” Jesus insisted.



13. But it was Peter who was wrong. “Stop saying this, Peter!” Jesus replied. “You might think you’re trying to protect Me, but you’re talking like Satan, God’s great enemy. You are tempting Me to disobey God’s good plan,” Jesus told Peter. “I **MUST** suffer and die on the cross to save God’s people.” Jesus insisted.

14. “If you’re going to follow Me, you must choose to obey God’s plan, too,” Jesus told the listening crowd. “You must take up your cross and follow Me.”

“Following Me will be hard. You will have to say “no” to sin, including some of the things the rest of the world enjoys. You may even lose your life to follow Me. But you will gain something even better: life with God forever,” Jesus told them.



14. "If you're going to follow Me, you must choose to obey God's plan, too." Jesus told the listening crowd. "You must take up your cross and follow Me. Following Me will be hard. You will have to say "no" to sin, including some of the things the rest of the world enjoys. You may even lose your life to follow Me. But you will gain something even better: life with God forever." Jesus told them.

15. “I’ve come to the world this time to suffer and die. But I’ll come back again as the great, glorious Forever King over all. Everyone will see Me as I come down from heaven, shiny with the bright glory of God,” Jesus said.

“The angels of heaven will be with Me when I burst through the sky. Then, I will judge all people,” Jesus told them. “I will give out last and fair punishments to all, according to what they have done,” He explained.



15. "I've come to the world this time to suffer and die. But I'll come back again as the great, glorious Forever King over all. Everyone will see Me as I come down from heaven, shiny with the bright glory of God," Jesus said. "The angels of heaven will be with Me when I burst through the sky. Then, I will judge all people," Jesus told them. "I will give out last and fair punishments to all, according to what they have done," He explained.

16. What will the Great Day of Judgment be like? What are the last and fair punishments that Jesus will give out?

Years later, Jesus gave John –another of His disciples-- a look at what it will be like. John wrote down what he saw in the Bible book we call Revelation.

“I saw a great, white throne with Jesus seated on it. Everyone who has ever lived stood before the throne,” John wrote.



16. What will the Great Day of Judgment be like? What are the last and fair punishments that Jesus will give out? Years later, Jesus gave John -another of His disciples-- a look at what it will be like. John wrote down what he saw in the Bible book we call Revelation. "I saw a great, white throne with Jesus seated on it. Everyone who has ever lived stood before the throne," John wrote.

17. “Then I saw great books opened up. In one book was written what each person had done in his life. This was the Book of Deeds. Jesus judged each person fairly, according to what each had done,” John wrote.



BOOK OF DEEDS

17. "Then I saw great books opened up. In one book was written what each person had done in his life. This was the Book of Deeds. Jesus judged each person fairly, according to what each had done." John wrote.

18. “Those who had chosen to keep on disobeying God and did not trust in Jesus as their Savior were sent out of God’s presence forever. How sad it will be for these people!” John said.



18. "Those who had chosen to keep on disobeying God and did not trust in Jesus as their Savior were sent out of God's presence forever. How sad it will be for these people!" John said.

19. “But there was another book. It was called the Book of Life,” John wrote. “In this book were written the names of all of God’s people --all who had turned away from disobeying God and trusted in Jesus as their Savior,” he explained.

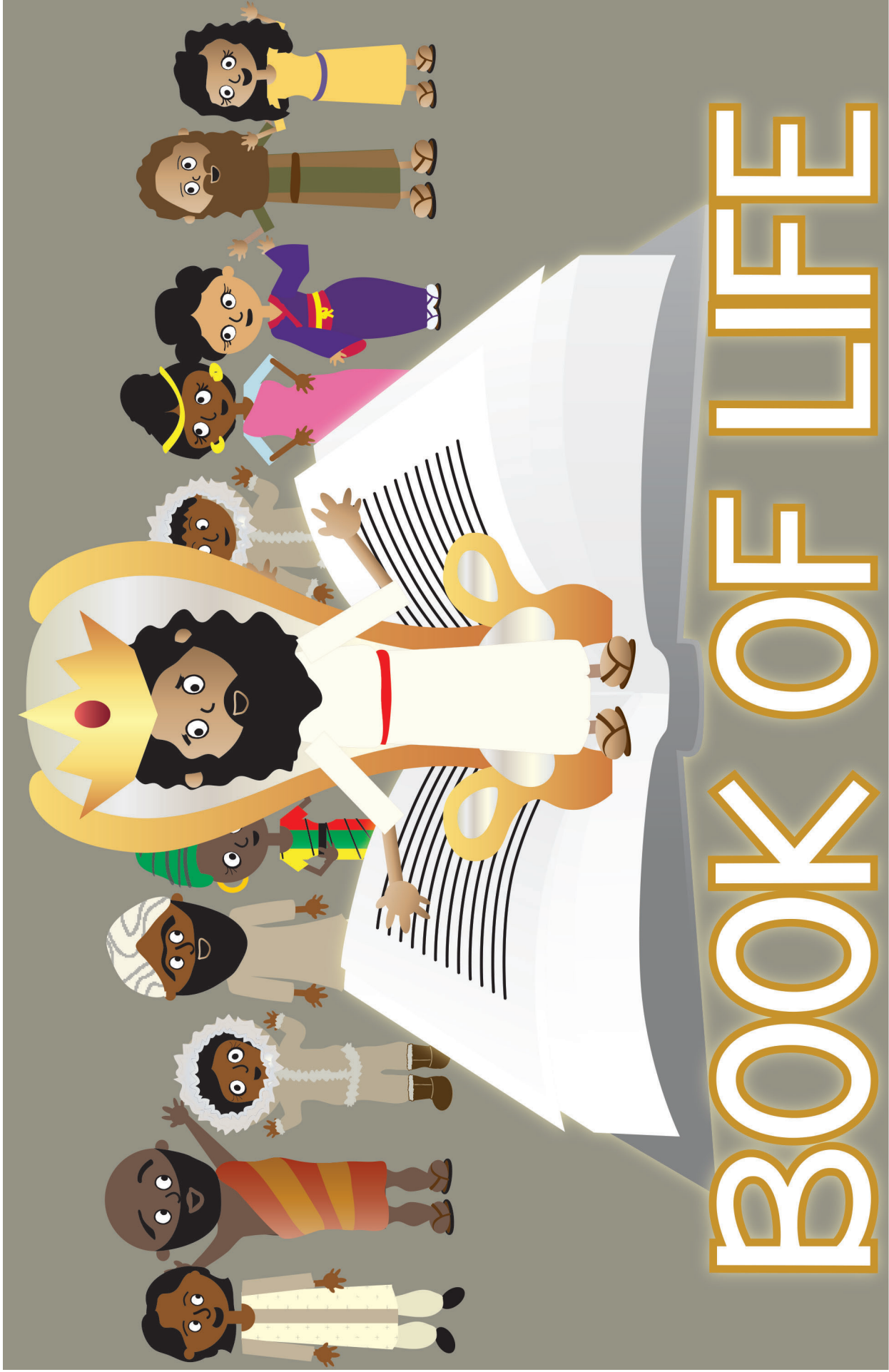

19. "But there was another book. It was called the Book of Life," John wrote. "In this book were written the names of all of God's people --all who had turned away from disobeying God and trusted in Jesus as their Savior," he explained.

20. “These people were sinners, too, but there will be no punishment for their sins. Instead, they will be rewarded as if they had lived the perfect life that Jesus had lived. Why? Because Jesus paid for their sins already when He suffered and died on the cross.”

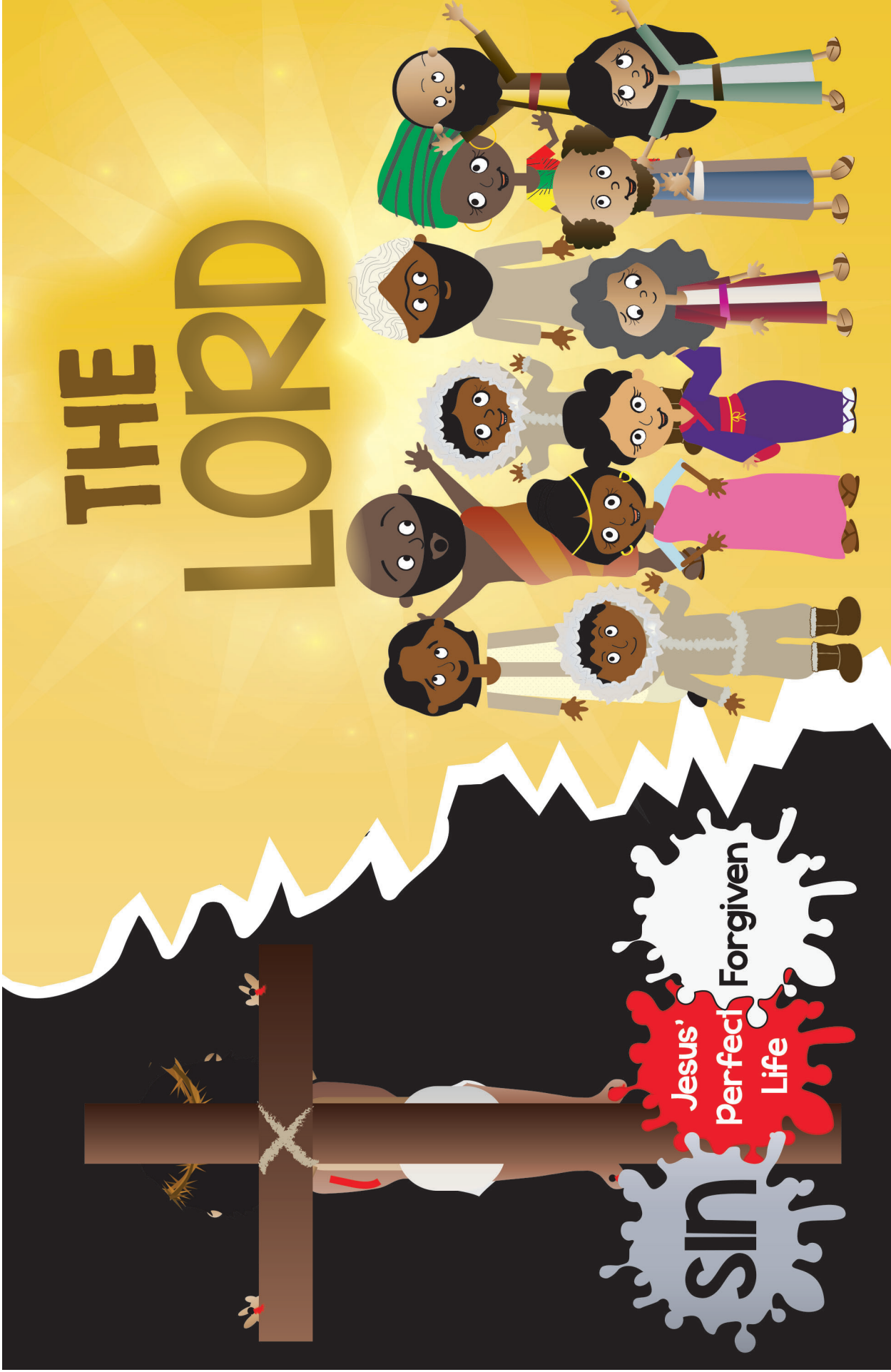

20. "These people were sinners, too, but there will be no punishment for their sins. Instead, they will be rewarded as if they had lived the perfect life that Jesus had lived. Why? Because Jesus paid for their sins already when He suffered and died on the cross."

21. “These people will never leave God’s presence. They will live with Him, enjoying His Perfect Wonderfulness as His dearly-loved people forever,” John wrote. “There will no more sickness, sadness, sin, or death for them. Only happiness forever.”

Oh, what a day that will be, when Jesus comes back as the Forever King and judges all people fairly. Only God knows exactly when that day will come, but we can be ready for it, whenever it is.

How? By turning away from our sins and trusting in Jesus as our Savior. Thank You, Jesus, for being merciful Savior now, so we can enjoy You as our good, Forever King on that day!



Perfect Wonderfulness

GOD

21. "These people will never leave God's presence. They will live with Him, enjoying His Perfect Wonderfulness as His dearly-loved people forever." John wrote. "There will no more sickness, sadness, sin, or death for them. Only happiness forever." Oh, what a day that will be, when Jesus comes back as the Forever King and judges all people fairly. Only God knows exactly when that day will come, but we can be ready for it, whenever it is. How? By turning away from our sins and trusting in Jesus as our Savior. Thank You, Jesus, for being merciful Savior now, so we can enjoy You as our good, Forever King on that day!

DDD 16.1 Simple Story Scenes

“The Case of the Two, Big Books” Matthew 16; Mark 8:27-38, Revelation 20:11-15



Detective Dan's Listening Assignment #1

1. Who will come back at the end of time? Jesus will.
2. What are the two, big books? What will He do with the two, big books? The Book of Deeds is the book that tells about every person's life—everything they've done, both good and bad. The Book of Life has the names of all who turned away from their sins and trusted in Jesus as their Savior. Jesus will judge all people fairly with these books. He will give them their final reward or punishment, according to how they have lived and whether they have asked God to forgive their sins through Jesus.

For You and Me:
It can be scary to think about Jesus coming back and judging us for what we've done. The good news is that all who turn away from their sins and trust in Jesus as their Savior can rejoice on that day! Yes, they've done many bad things, but they are forgiven through Jesus. God can help us be ready for that day. He can forgive our sins and make us His people when we turn away from our sins and trust in Jesus as our Savior.



Detective Dan's Listening Assignment #2

Revelation 22:12, ESV

“Behold, I am coming soon, bringing my recompense with me, to repay each one for what he has done.”

1. Who is coming back?
Jesus is.
2. What will He do He comes back?
Jesus will judge all people fairly.

For You and Me:

It can be scary to think about Jesus coming back and judging us for what we've done. The good news is that all who turn away from their sins and trust in Jesus as their Savior can rejoice on that day! Yes, they've done many bad things, but they are forgiven through Jesus. God can help us be ready for that day. He can forgive our sins and make us His people when we turn away from our sins and trust in Jesus as our Savior.

DDD 16.1 Simple Story Scenes

What Will Happen When Jesus Comes Back?
God Will Make Everything New...
Jesus Will Judge All People Fairly!

The Gospel

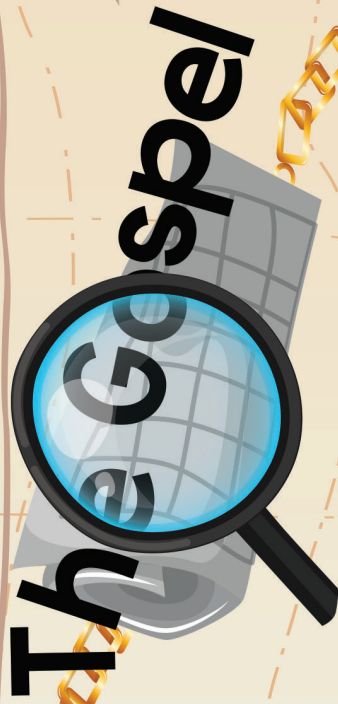

How merciful God has been to us! Even though we have all disobeyed Him and all deserve His punishment, He sent Jesus to be our Savior. Jesus lived a perfect life and offered it as full payment for the sins of God's people when He died on the cross. On the third day, He rose from the dead in victory.

Now, all who turn away from their sins and trust in Jesus as their Savior will be forgiven. They are God's people. On the day Jesus gives out punishment for sin, there will be no punishment for them. Jesus already took it for them on the cross. They will live forever with God in the wonderful, new world God is making for them. We can be God's people, too, when we turn away from our sins and trust in Jesus as our Savior. Ask Him to help you. He loves to!



DDD 16.1 Simple Story Scenes

A Prayer

A We praise You, Jesus, for being the good Judge who will give out fair rewards and punishments to all people at the end of time.

C Jesus, we know that we are all sinners. We have all disobeyed God's laws. We deserve Your judgement on our sins. We need You to be our Savior.

T Thank You, Jesus, for dying on the cross to save all who turn away from their sins and trust in You as their Savior. Thank You that You will judge all who do, according to Your perfect life, not their own. If we trust in You, we don't have to fear Your punishment on that day, either. We can look forward, in excitement, to life with You forever.

S Work in our hearts! Help us all to turn away from our sins and trust in You as our Savior. Help us to do good things with the gifts You have given us. Help us to love You and love others. Come back soon, Jesus!

In Jesus' name we pray, Amen.



DDD 16.1 Simple Story Scenes

DEEP DOWN DETECTIVES



Simple Story Scenes

Unit 16,

Bible Truth 2

Using Simple Story Scenes as a Curriculum

Introduce the Key Concept and Bible Verse

Simple Story Scenes give you the basics for the core of your lesson. You can use the overview sheet to introduce and explain the key concept and Bible verse.

Give the Case Assignment

Give the children a Detective Dan listening assignment. Two are provided. You can add a third using the ideas on the bonus, third take-home sheet, if desired. Each listening assignment, let's you teach the story with a different learning emphasis.

Show & Tell the Story

Hold up the pictures and tell the story from the story scenes. Alternatively, you can find in the and Pieces section for this unit at praisefactory.org, these same listening assignments and story scenes, gospel and ACTS prayer modified for view on a screen. Simply download them or open them online and show through your own monitor (tablet, big screen, whatever).

Solve the Case

Repeat Detective Dan's listening assignment question and discuss the answer.

Share the Gospel

Share the gospel tie-in with the kids.

Close in ACTS Prayer

Pray the ACTS prayer with the kids. If using the curriculum with older children, give them a chance to think up their own ACTS tie-ins to the story, using the one provided as cues/ideas for you.

Review Time

Give out the take-home sheet (there are three: two that correlates to the two Detective Dan assignments in the Story Scenes, and a bonus third one.) As the children are coloring, use the take-home sheet discussion questions or your own questions to further review and apply the key concepts, Bible verse, and story truths to the children.

Looking for more?

Online, in the Bits and Pieces section for this unit, you will find review games, crafts, storyboard flannelgraph figures, and audio and sheet music for all of the songs. There are also full lesson plans that offer more of a script and take this curriculum's possibilities to much more depth. Don't forget to tell the parents about the Parents Resources section where they can read through the Story scenes and download take homes with their kids.

Unit 16: Jesus, the Returning King

Unit Big Question (and Answer): What Will Happen When Jesus Comes Back?
God Will Make Everything New!

Unit Bible Verse: "And he who was seated on the throne said, "Behold, I am making all things new...It is done! I am the Alpha and the Omega, the beginning and the end."--Revelation 21:5-6, ESV

Bible Truth 2 Concept: God Will Make Everything New... God's People Will Live Happily with God Forever!

Have you ever been to a wedding? If you have, perhaps you've watched how happy the bride (woman) and groom (man) are to get married. They love each other so much and love being together. They are so happy on their wedding day! It's the day they begin to live the rest of their lives together.

The Bible says that Jesus is like a groom waiting for the day of His wedding. Not because He's going to get married to a woman, but because He is waiting to be joined forever with God's people, whom He loves so much. They are like a bride to Him.

At the end of world, it will be like a wedding day for Jesus and God's people. That will be the day when, at last, Jesus and God's people start living together in the new heaven and earth, He's creating for them. There will be a great celebration called the Wedding Feast of the Lamb ("the Lamb" is a nickname for Jesus that reminds God's people that He died to save them). What a lot there will be to celebrate! Jesus will rule as king forever. All of God's people will love Him and obey Him all the time. There will never be any sadness or hurting or dying anymore. Best of all, God's people will be completely filled up with knowing and enjoying God and each other in a way that can only be described as Perfect Wonderfulness. And it will be like this forever and ever and ever. We can become God's people, too, when we turn away from our sins and trust in Jesus as our Savior.

Bible Truth 2 Bible Verse: Revelation 19:6-7, ESV

"Hallelujah! For the Lord our God the Almighty reigns. Let us rejoice and exult and give him the glory, for the marriage of the Lamb has come, and his Bride has made herself ready."

Learn a Little: "Hallelujah! For the Lord our God the Almighty reigns."

Meaning

This song is full of Bible words! "Hallelujah" is a Bible word that means "Praise the Lord." That's exactly what God's people will be doing when Jesus comes back to take them home to live with Him in the new heaven and earth forever!

"The Lamb" is a nickname for Jesus, who died on the cross as the perfect payment for the sins of God's people. Jesus has given God's people the nickname of "His Bride." They are His special people who He loves so much and will be joined to them forever. How happy they will live together, forever and ever. They will rejoice with a big celebration! We can become God's people when we turn away from our sins and trust in Jesus as our Savior.

Bible Truth 2 ACTS Prayer

- A** We praise You, Jesus! You are the great King who now rules over everything in heaven and will return one day. You will do away with sin, sadness, and death. You will be the great King over the new heaven and earth forever.
- C** Jesus, we know that we disobey You and all of God's good laws. We can never be good enough on our own to deserve to live with You when You return. We ask You to forgive us! Be our Savior, so we can be God's people and live with You forever.
- T** Thank You, Jesus, for coming to be our Savior! Thank You that we can be God's people when we turn away from our sins and trust in You as our Savior. Thank You for promising to get rid of sin, sadness, and death when You come back again. Thank You that You will create a perfect, new world for God's people to enjoy with You forever.
- S** Work in our hearts. Help us to turn away from our sins and trust in You, Jesus, as our Savior. Help us to love You and live for You today. Help us to look forward to the day when You come back and make all things new. Come back soon, Jesus! In Jesus' name we pray, Amen.

Bible Truth 2 Story**The Case of the Promise Keeper**

Isaiah 1,2,6,24,25,49,52-53,60,65,66; Daniel 3; Revelation 21

Songs Used in Bible Truth 2

Big Q & A 16 Song

Big Question 16 Song: What Will Happen When Jesus Comes Back?

Big Question 16 Bible Verse Song: And He Who Was Seated Revelation 21:5-6, ESV

Extra Big Question 16 Bible Verse Song: I Am Making All Things New Revelation 21:5, NIV 1984

Big Question 16 Hymn: At the Name of Jesus, v.1

Big Question 16 Praise Song: He Is Lord

Bible Truth 2 Bible Verse Song: Hallelujah, Hallelujah! Revelation 19:6-7, ESV

Bible Truth 2 Extra Bible Verse Song: Hallelujah! Revelation 19:6-7, ESV

Bible Truth 2 Extra Bible Verse Song: We'll All Be Changed 1 Corinthians 15:51,52,54, ESV

Bible Truth 2 Extra Bible Verse Song: Behold a Great Multitude Revelation 7:9-10, ESV

27 Bible Verse: No More Death Revelation 21:3-4;22:3-8, ESV

listen to or download songs for free at <https://praisefactory.org>: Deep Down Detectives Music page

“The Case of the Promise Keeper”

Isaiah 1,2,6,24,25,49,52-53,60,65,66; Daniel 3; Revelation 21

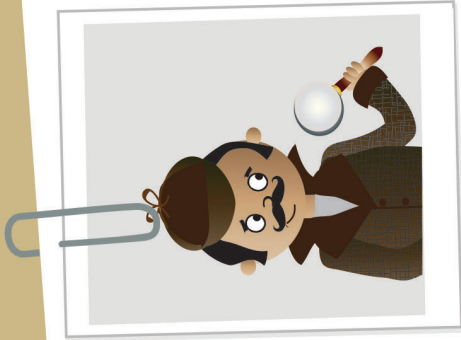

Detective Dan's Listening Assignment #1

1. What promises were the people of Israel waiting to come true?

2. Who has come and will come again, so that all these promises come true?



Detective Dan's Listening Assignment #2

Revelation 19:6-7, ESV

“Hallelujah! For the Lord our God the Almighty reigns. Let us rejoice and exult and give him the glory, for the marriage of the Lamb has come, and his Bride has made herself ready.”

1. Who were the people of Israel looking forward to coming and being their Forever King?

2. What was the name of that king? What will it be like when He comes back?

(more listening and discussion questions are included in the curriculum at praisefactory.org)

I. “Promises, promises! When will the LORD ever give us what He promised?” the people of Israel wanted to know.

Long ago, the LORD promised Abraham that a son from his family, the people of Israel, would bless all peoples in the world. But where was this special blessing? He STILL had not come!



I. "Promises, promises! When will the LORD ever give us what He promised?" the people of Israel wanted to know. Long ago, the LORD promised Abraham that a son from his family, the people of Israel, would bless all peoples in the world. But where was this special blessing? He STILL had not come!

2. Promises, promises! The LORD promised this son would also come from King David's family. He would be the Forever King and would rule over God's people for all eternity. How happy would life be with Him in charge!



2. Promises, promises! The LORD promised this son would also come from King David's family. He would be the Forever King and would rule over God's people for all eternity. How happy would life be with Him in charge!

3. No wonder the people longed for this special Son to come. Their lives were so unhappy, and it was their own fault.

Instead of keeping God's good laws, they had chosen to break them, again and again. Instead of worshipping the LORD, they had chosen to worship fake gods, again and again. And, instead of learning God's Word, they had chosen to forget it, again and again.

So, instead of pouring out His blessings upon them, the LORD had to discipline them, again and again.



3. No wonder the people longed for this special Son to come. Their lives were so unhappy, and it was their own fault. Instead of keeping God's good laws, they had chosen to break them, again and again. Instead of worshipping the LORD, they had chosen to worship fake gods, again and again. And, instead of learning God's Word, they had chosen to forget it, again and again. So, instead of pouring out His blessings upon them, the LORD had to discipline them, again and again.

4. “March, march, march!” came the mighty soldiers of Babylon into Judah and Jerusalem.

“Crash, smash, burn!” down went their houses, and even the Temple, the LORD’s beautiful worship place. Then, “Tromp, tromp, tromp,” off went the people of Israel to Babylon, where they had to work hard for their enemies.



4. "March, march, march!" came the mighty soldiers of Babylon into Judah and Jerusalem. "Crash, smash, burn!" down went their houses, and even the Temple, the LORD's beautiful worship place. Then, "Tromp, tromp, tromp," off went the people of Israel to Babylon, where they had to work hard for their enemies.

5. How sad the people of Israel were in the faraway land of their enemies! But they knew this was the LORD's punishment, and they knew they deserved it.

Now, they were so very, very sorry. They wanted to turn back to the LORD, but was it too late? Were God's promises to them really gone?



5. How sad the people of Israel were in the faraway land of their enemies! But they knew this was the LORD's punishment, and they knew they deserved it. Now, they were so very, very sorry. They wanted to turn back to the LORD, but was it too late? Were God's promises to them really gone?

6. The LORD gave them His answer through His prophets, Isaiah and Daniel. It was good news.

“Though your sins are so many, I, myself, will provide the way for you to be forgiven,” the LORD told the people. “I have not forgotten my promises. I will keep them all. I won’t punish you forever. When seventy years have passed, I will bring you back home,” He promised them.

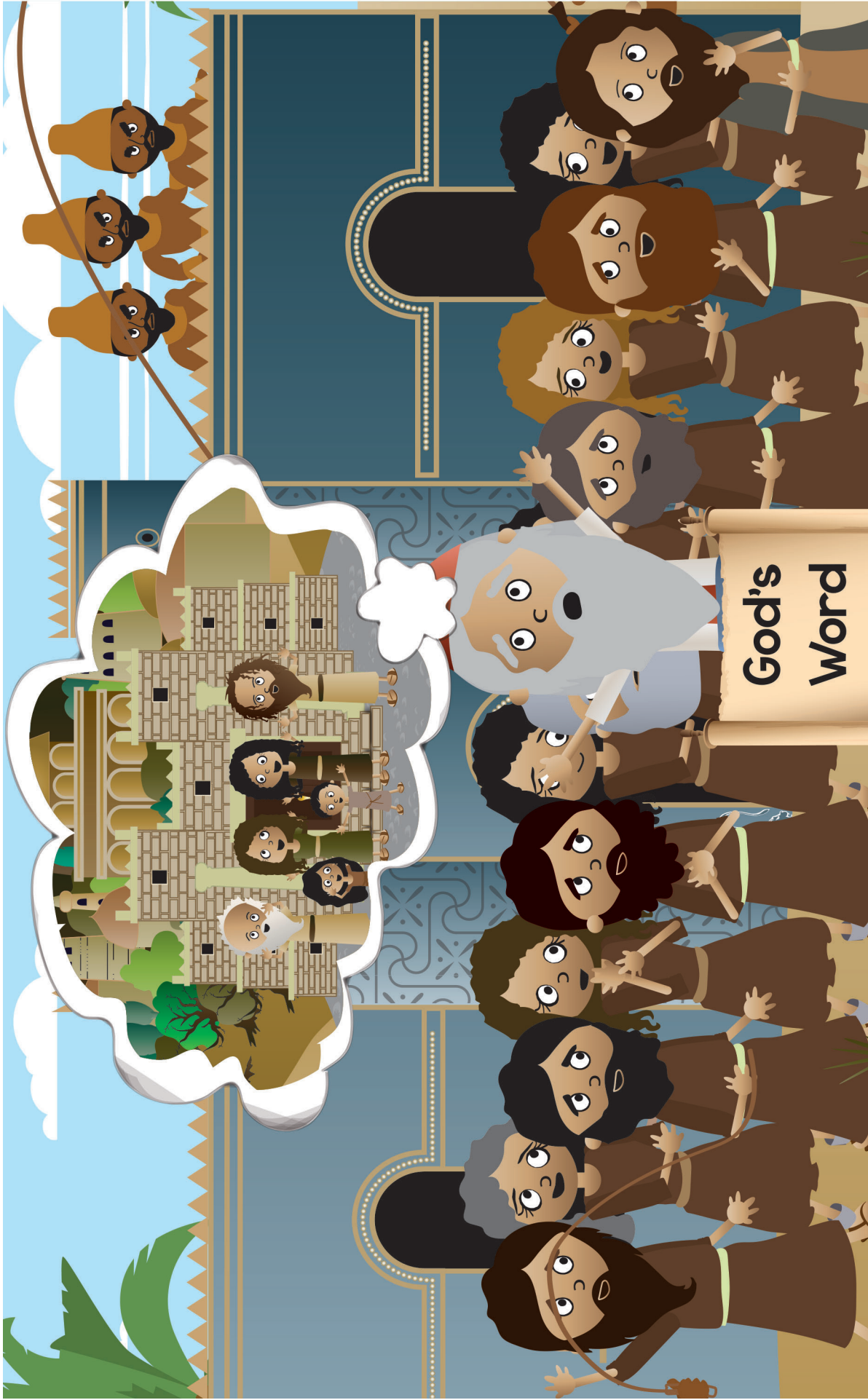

6. The LORD gave them His answer through His prophets, Isaiah and Daniel. It was good news. "Though your sins are so many, I, Myself, will provide the way for you to be forgiven," the LORD told the people. "I have not forgotten My promises. I will keep them all. I won't punish you forever. When seventy years have passed, I will bring you back home," He promised them.

7. That was great news, but the LORD had more, even BETTER news for them: “A son of Abraham will STILL come and bless all the peoples of the world. This son of David will STILL come and rule as the Forever King,” the LORD promised.

“But He won’t be just a son of Abraham and a son of David,” the LORD said. “He will be MY Son, the Son of God. He will die for the sins of all MY people. Then, He will rise from the dead, in victory over sin and death,” the LORD comforted them.



7. That was great news, but the LORD had more, even BETTER news for them: “A son of Abraham will STILL come and bless all the peoples of the world. This son of David will STILL come and rule as the Forever King,” the LORD promised. “But He won’t be just a son of Abraham and a son of David,” the LORD said. “He will be MY Son, the Son of God. He will die for the sins of all My people. Then, He will rise from the dead, in victory over sin and death,” the LORD comforted them.

8. “Then, at the end of time, My Son will return to earth,” the LORD promised. “He will judge all people fairly.”

“Those who have NOT turned to the LORD will be separated from God forever. The time to receive God’s forgiveness will be passed for them. It will be a very, very sad day for those people.”



8. "Then, at the end of time, My Son will return to earth," the LORD promised. "He will judge all people fairly. Those who have NOT turned to the LORD will be separated from God forever. The time to receive God's forgiveness will be passed for them. It will be a very, very sad day for those people."

9. “But how wonderful it will be for God’s people, all who turned away from their sins and trusted in Him as their Savior.”

“I will create a new heaven and earth for them to live in with me. It will be a wonderful, new world of perfect happiness,” the LORD said through His prophets.

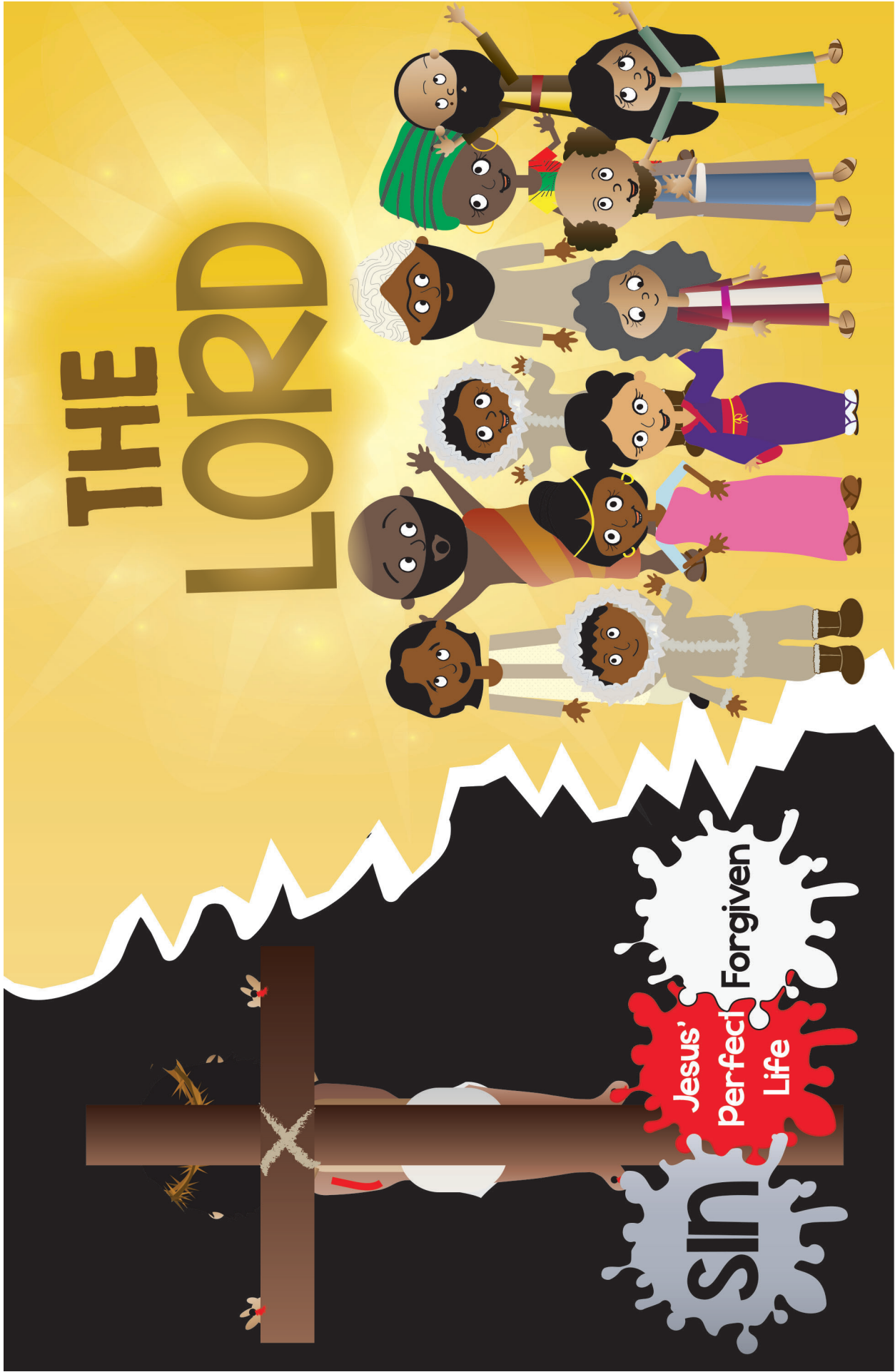

9. "But how wonderful it will be for God's people, all who turned away from their sins and trusted in Him as their Savior. I will create a new heaven and earth for them to live in with Me. It will be a wonderful, new world of perfect happiness," the LORD said through His prophets.

10. “NEVER will there be sadness or death. NEVER will anyone disobey Me anymore. They will delight to worship Me,” the LORD told the people of Israel.

“And the Forever King, will rule on and on, and God’s people will live in the bright light of His glory forever,” the LORD promised the people.



10. "NEVER will there be sadness or death. NEVER will anyone disobey Me anymore. They will delight to worship Me," the LORD told the people of Israel. "And the Forever King, will rule on and on, and God's people will live in the bright light of His glory forever," the LORD promised the people.

II. Oh, what wonderful promises these were for those people of Israel, far away in the land of their enemies! How good the LORD is to His people! His love is more than they could ever deserve. God **WOULD forgive and save all who turned back to Him in faith and repentance.**



II. Oh, what wonderful promises these were for those people of Israel, far away in the land of their enemies! How good the LORD is to His people! His love is more than they could ever deserve. God **WOULD** forgive and save all who turned back to Him in faith and repentance.

12. Promises, promises. Did God keep His promises to the people of Israel?

Yes, He did! At just the right time, the LORD rescued them from their enemies and led them back home to Jerusalem. There was so much to do, but oh, how good it was to be home!



12. Promises, promises. Did God keep His promises to the people of Israel? Yes, He did! At just the right time, the LORD rescued them from their enemies and led them back home to Jerusalem. There was so much to do, but oh, how good it was to be home!

13. And, at just the right time, God sent the special Son—Abraham's son, David's son, GOD'S SON!

He came to bless all the peoples of the world, and to save God's people from their sins. He was born in Bethlehem one night, and angels sang and rejoiced at His birth.

Do you know His name? I bet you do! It's Jesus!



13. And, at just the right time, God sent the special Son—Abraham's son, David's son, GOD'S SON! He came to bless all the peoples of the world, and to save God's people from their sins. He was born in Bethlehem one night, and angels sang and rejoiced at His birth. Do you know His name? I bet you do! It's Jesus!

14. That little baby, Jesus, grew up to be a man, a perfect man --the ONLY person who never, ever disobeyed God. He taught about God and He did amazing things.



14. That little baby, Jesus, grew up to be a man, a perfect man --the ONLY person who never, ever disobeyed God. He taught about God and He did amazing things.

15. He suffered and died on the cross for the sins of God's people and was buried in a cave-grave.



15. He suffered and died on the cross for the sins of God's people and was buried in a cave-grave.

16. But on Day Three, Jesus rose up from the dead in victory. Jesus had beaten sin and death for God's people!



16. But on Day Three, Jesus rose up from the dead in victory. Jesus had beaten sin and death for God's people!

17. For forty days, Jesus spent time with His disciples, teaching them many things. Then, up to heaven, Jesus went, and He is there now, ruling as the Forever King.



17. For forty days, Jesus spent time with His disciples, teaching them many things. Then, up to heaven, Jesus went, and He is there now, ruling as the Forever King.

18. Promises, promises. One day, God will keep the last of His promises. On that wonderful day, Jesus will come back to this world again. Everyone will see Him as He comes through the clouds.



18. Promises, promises. One day, God will keep the last of His promises. On that wonderful day, Jesus will come back to this world again. Everyone will see Him as He comes through the clouds.

19. Jesus will judge all people fairly, and then, this old, broken world will be destroyed.



BOOK OF DEEDS

19. Jesus will judge all people fairly, and then, this old, broken world will be destroyed.

20. God will create a new, perfect world in its place. And in this wonderful, new home, God's people will live with God forever.

At last, they will get to know and enjoy Him fully. At last, they will get to know and enjoy each other fully, too. Sickness, sadness, sin, and death will be gone forever. It will be Perfect Wonderfulness that will never end. Come, Lord Jesus, come! Amen!



Perfect Wonderfulness

20. God will create a new, perfect world in its place. And in this wonderful, new home, God's people will live with God forever. At last, they will get to know and enjoy Him fully. At last, they will get to know and enjoy each other fully, too. Sickness, sadness, sin, and death will be gone forever. It will be Perfect Wonderfulness that will never end. Come, Lord Jesus, come! Amen!

DDD 16.2 Simple Story Scenes

“The Case of the Promise Keeper”

Isaiah 1,2,6,24,25,49,52-53,60,65,66; Daniel 3; Revelation 21

SOLVED

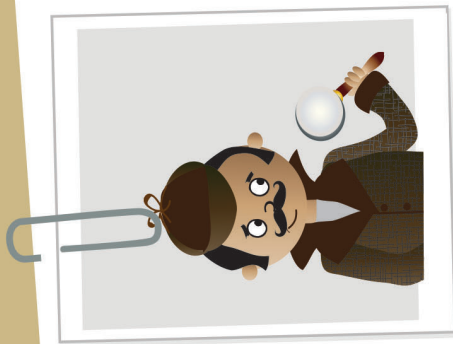

Detective Dan's Listening Assignment #1

1. What promises were the people of Israel waiting to come true?
God's promise to send a Son who would bless all nations and who would be the Forever King.
 2. Who has come and will come again, so that all these promises come true?
Jesus!
- For You and Me:
Like the people of Israel, we have all chosen to disobey God we all deserve His punishment. But through Jesus, God offers forgiveness for our sins. And the same promises that the people of Israel were waiting to come true will be promises that we're waiting to come true, too. What a wonderful day it will be when Jesus comes back to reign as the great, Forever King! God's people live with Him forever. It can be a happy day for us, too, if we turn away from our sins and trust in Jesus as our Savior.



Detective Dan's Listening Assignment #2

Revelation 19:6-7, ESV

“Hallelujah! For the Lord our God the Almighty reigns. Let us rejoice and exult and give him the glory, for the marriage of the Lamb has come, and his Bride has made herself ready.”

1. Who were the people of Israel looking forward to coming and being their Forever King?
A special son God would send.
 2. What was the name of that king? What will it be like when He comes back?
Jesus is the name of that Forever King. He will do away with sin and death. He will create a new heaven and earth to replace this broken one. Jesus will live together with God's people forever. How happy they will be!
- For You and Me:
The day Jesus comes back will be a great day of celebration for God's people. They look forward to living with Him forever. They look forward to sin and death been gone forever. We can become God's people, too. How? By turning away from our sins and trusting in Jesus as our Savior. Then, we will be able to look forward to celebrating on that day and living with Jesus forever, too.

DDD 16.2 Simple Story Scenes

What Will Happen When Jesus Comes Back?
God Will Make Everything New...
God's People Will Live Happily with God Forever!

The Gospel

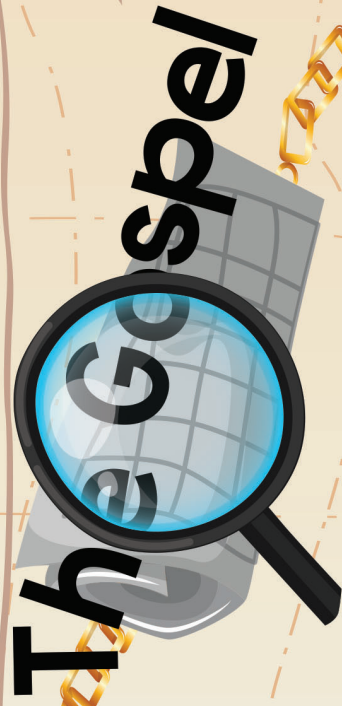

How merciful God has been to us! Even though we have all disobeyed Him and all deserve His punishment, He sent His Son, Jesus, to be our Savior. Jesus lived a perfect life and offered it as full payment for the sins of God's people when He died on the cross. On the third day, Jesus rose from the dead in victory. He had beaten sin and death for God's people!

Now, all who turn away from their sins and trust in Jesus as their Savior will be forgiven. They are God's people. They will live forever with God in the wonderful, new world God will make. We can be God's people, too, when we turn away from our sins and trust in Jesus as our Savior. Ask Him to help you. He loves to answer this prayer!



DDD 16.2 Simple Story Scenes

A Prayer

A We praise You, Jesus! You are the great King who now rules over everything in heaven and will return one day. You will do away with sin, sadness, and death. You will be the great King over the new heaven and earth forever.

C Jesus, we know that we disobey You and God's good laws. We can never be good enough on our own to deserve to live with You when You return. We need a Savior!

T Thank You, Jesus, that we can be God's people when we turn away from our sins and trust in You as our Savior. Thank You for promising to get rid of sin, sadness, and death when You come back again. Thank You that You will create a perfect, new world for God's people to enjoy with You forever.

S Work in our hearts. Help us turn away from our sins and trust in You as our Savior. Help us to love You and live for You today. Help us to look forward to the day when You come back and make all things new. Come back soon, Jesus!

In Jesus' name we pray. Amen.



DDD 16.2 Simple Story Scenes

DEEP DOWN DETECTIVES



Take-Home Sheets

CAN YOU GUESS BIBLE TRUTH!
**What Will Happen When Jesus
Comes Back?**
God Will Make Everything New...

Jesus Will Judge All People

----- !

**HINT: "This is another word for treating
everyone right. It starts with an "F" and it
rhymes with "barely"**

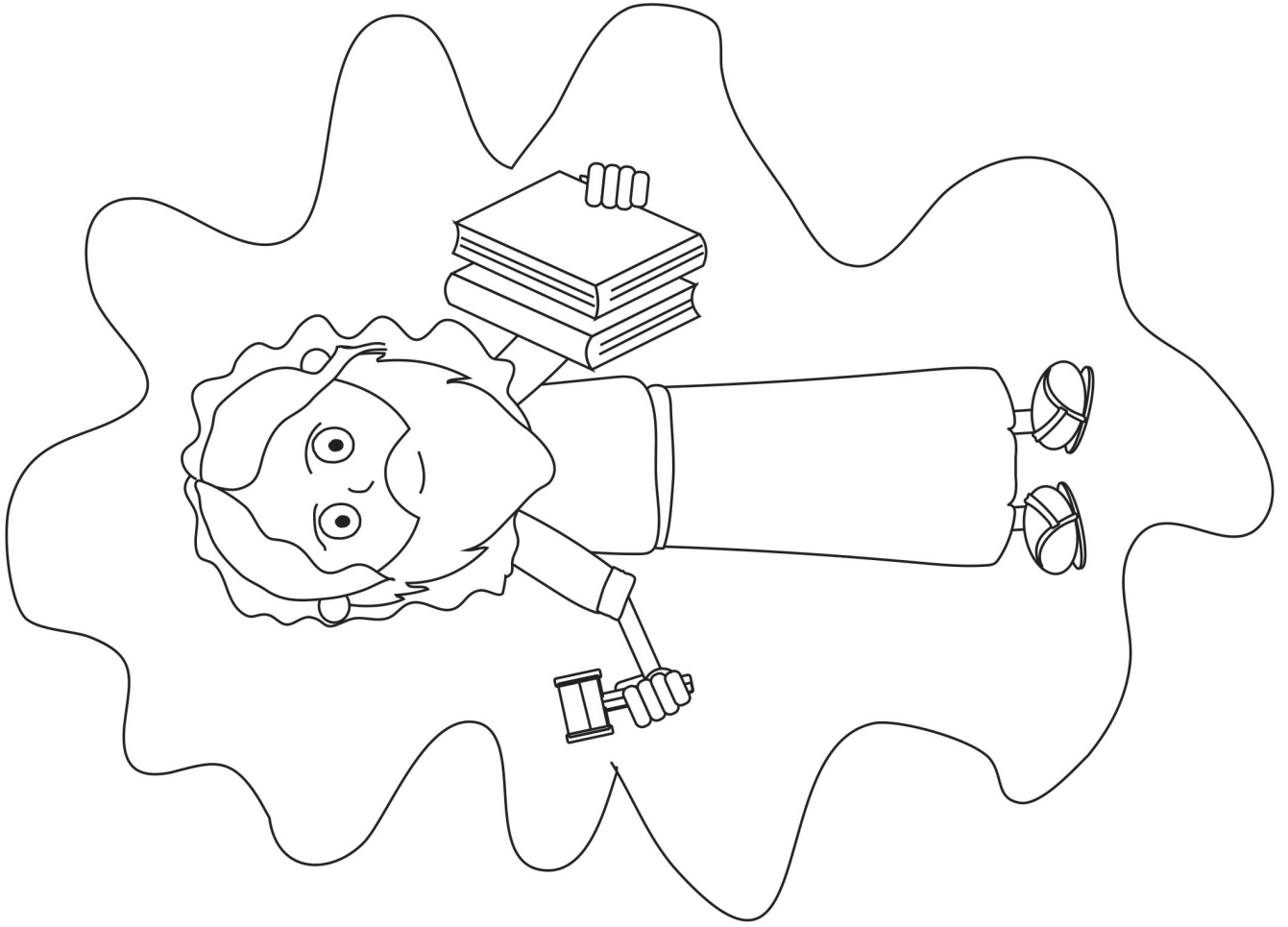

Deep Down Detective Devotion: Unit 16, Bible Truth 1, Lesson 1



Big Question 16: What Will Happen When Jesus Comes Back?

Answer: God Will Make Everything New... Jesus Will Judge All People Fairly!

Bible Truth 1 Meaning

When Jesus comes back, He will gather everyone who has ever lived before Him to be judged fairly. All the people who are alive when Jesus comes back, will stand before Him. All the people who were already dead will come out of the places they are buried and appeared before Him, too. Millions and millions, billions and billions of people. There will be more people than WE can know or count standing before Jesus on that day. But they will not be too many for Jesus. Jesus is God's Son. He knows every one of those people, inside and out. He knows their whole life. Yes, Jesus knows them all completely; and on that day, He will judge them all. What does it mean to judge? It means that Jesus will think fairly about what each person did with the life God gave them. Did they love God and serve Him? Did they love others? How did they use the good gifts God gave them? And most importantly, did they turn away from their sins and trust in Jesus as their Savior... or, did they refuse Him? It will be the saddest of days for all who refused to turn away from their sins and trust in Jesus as their Savior. The day for forgiveness and mercy will be over. Now, they will be separated from God and everything good forever. Satan and all the angels who rebelled against God will receive this final, terrible punishment, too. Oh, how I wish that everyone would turn away from their sins and trust in Jesus instead of receiving God's punishment! But what about God's people? How will Jesus fairly think about them? Didn't they disobey God, too? Shouldn't they be separated from God, too? Yes, they did disobey God, too. Yes, they deserve to be separated from God; but instead, they will receive wonderful, eternal life with God on that day! Why? Because they turned away from their sins and asked for God's forgiveness. They trusted in Jesus as their Savior, and He paid for their sins when He died on the cross. Because of Jesus, this will be a day of praise for them. Jesus will reward them for the good works they did in His name. And best of all, they will get to live happily with God in special closeness forever. We can be ready for that day, too, if we turn away from our sins and trust in Jesus as our Savior. This is how we become God's people.

How do I know this is true? The Bible tells me so!

"Behold, I am coming soon, bringing my recompense with me, to repay each one for what he has done. I am the Alpha and the Omega, the first and the last, the beginning and the end." -- Revelation 22:12-13, ESV

Some Questions for You

1. Who will Jesus gather together when He comes back? *All people who have ever lived.*
2. What will Jesus do for each person? *Judge how they lived their life. Whether they turned away from their sins and trusted in Him (Jesus) as their Savior or not.*
3. What will happen to those who chose to keep on disobeying God and did not trust in Jesus as their Savior? *They will receive God's punishment and it will be very, very sad!*
4. What will happen to God's people, to those who did turn away from disobeying God and trusted in Jesus as their Savior? *They will go to live with God forever.*
5. On whose life does Jesus judge people who did not trust in Him as their Savior? *On their own life. They will receive God's fair punishment for their sins since they were not forgiven.*
6. Why won't God's people be punished for their sins when Jesus judges their lives? *Because Jesus already paid for their sins when He died on the cross.*
7. On whose life does Jesus judge people who did trust in Him as their Savior? *On Jesus' perfect life. They will receive the wonderful reward of Jesus, God's Son. Their sins are forgiven. They will go to live with God forever.*
8. How can we be God's people? *By turning away from our sins and trusting in Jesus as our Savior.*

Let's Pray!

- A** We praise You, Jesus, for being the good Judge who will give out fair rewards and punishments to all people at the end of time. We praise You for being the Savior who offers to forgive us and make us God's people, so we can live with You and celebrate on that day You judge us all.
- C** Jesus, we know that we are all sinners. We have all disobeyed God's laws. We can never deserve to be God's people on our own. We need You to be our Savior!
- T** Thank You, Jesus, that we do not have to depend on our own goodness on the day You judge us. Thank You for dying on the cross to save all who turn away from their sins and trust in You as their Savior. Thank You that You will judge all who do according to Your perfect life, not their own. You have taken God's punishment in their place. They are forgiven. If we trust in You, we don't have to fear Your punishment on that day. We can look forward in excitement to life with You forever.
- S** Work in our hearts! Help us all to turn away from our sins and trust in You as our Savior. Help us to do good things with the gifts You have given us. Help us to love You and love others. Come back soon, Jesus! In Jesus' name we pray, Amen.

Let's Sing about What We're Learning!

Go to the Deep Down Detectives Parent Resources for Unit 16 to get the Bible story and many more resources and songs for this unit at praisefactory.org

Big Q & A 16 Song from Deep Down Detectives ESV Songs 16, track 12

(adapted version of (adapted version of "The Bear Went Over the Mountain))

What will happen when Jesus comes back?	God will make everything new,
What will happen when Jesus comes back?	God will make everything new.
What will happen when Jesus comes back?	What will happen when Jesus comes back?
God will make everything new.	What will happen when Jesus comes back?
	What will happen when Jesus comes back?
	God will make everything new.

Big Question 16 Action Rhyme Song from Deep Down Detectives ESV Songs 16, track 13

What will happen when Jesus comes back?

God will make everything new.

Refrain:

He'll make ev'rything new,
When He bursts through the blue.
No more sin, sickness, dying,
Only life, pure and good.
That's what will happen
When Jesus comes back!
Oh, Lord, come quickly,
Lord Jesus, come back!

Verse 1

What will happen when Jesus comes back?
This heav'n and earth will end, that's a fact!
God will destroy it, A perfect, new one make.
The home of God with His people always.
Refrain

Verse 2

What will happen when Jesus comes back?
All God's enemies will get the sack!
Sin, sickness, death will all be defeated,
On the throne forever, Jesus be seated.
Refrain

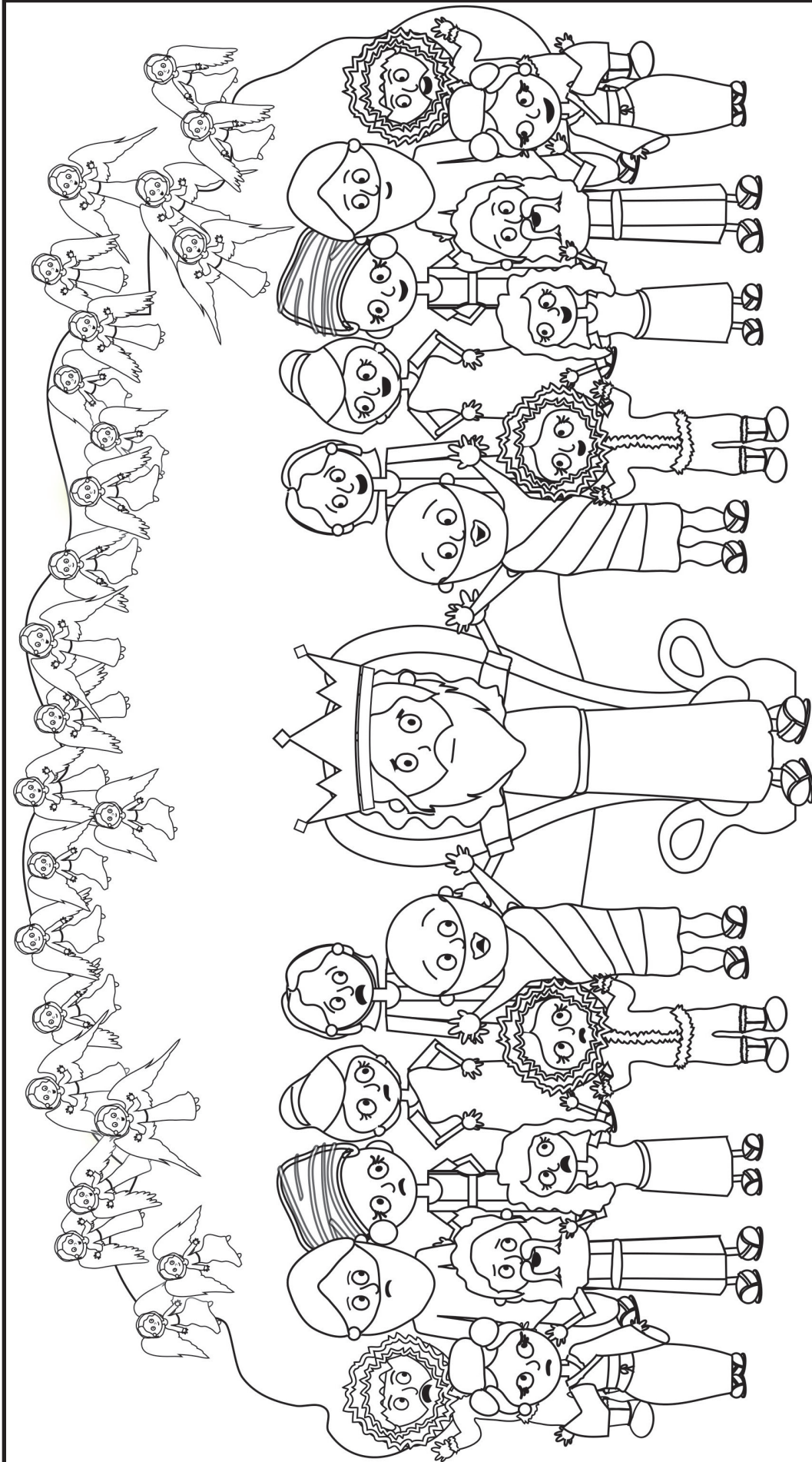

"Behold, I am coming soon, bringing my recompense with me, to repay each one for what he has done. I am the Alpha and the Omega, the first and the last, the beginning and the end."
Revelation 22:12-13, ESV

Deep Down Detective Devotion: Unit 16, Bible Truth 1, Lesson 2



Big Question 16: What Will Happen When Jesus Comes Back?

Answer: God Will Make Everything New... Jesus Will Judge All People Fairly!

How do I know this is true? The Bible tells me so!

"Behold, I am coming soon, bringing my recompense with me, to repay each one for what he has done. I am the Alpha and the Omega, the first and the last, the beginning and the end." -- Revelation 22:12-13, ESV

Learn a Little: "I am coming soon to repay each one for what he has done."

Meaning

One day, Jesus will come back. He will bring an end to sin and death. He will fairly judge everyone. Oh, what an awful day it will be for those who did not turn away from their sins and trust in Jesus! There will be no good reward for them. Only God's punishment for their sins. How sad! But the day Jesus comes back will be a wonderful day of celebration for God's people! He will reward the good things that God did through them. And because they did turn away from their sins and trusted in Him as their Savior, they will go to live with Him forever in the new heaven and earth He will create for them. We will be there on that day, too. It can be a day of celebration for us, too, if we turn away from our sins and trust in Jesus as our Savior.

Some Questions for You

1. Who promises to come soon? *Jesus does.*
2. What does Jesus promise to give to everyone? *A reward based on what they have done.*
3. What will Jesus give to those who never asked for God's forgiveness for their sins and never trusted in Him as their Savior? *It will be a sad day. They will receive God's punishment for their sins.*
4. What will Jesus give to those who did ask for God's forgiveness for their sins and did trust in Jesus as their Savior? *He will reward them with life with Him forever.*
5. How is Jesus the Beginning and the End? *All things were created through Him in the beginning. He is the one who will come back to end this world and judge us all fairly.*
6. How can we be ready for the day when Jesus judges all people? *By turning away from our sins and trusting in Jesus as our Savior.*

Let's Pray!

- A** We praise You, Jesus, for being the good Judge who will give out fair rewards and punishments to all people at the end of time. We praise You for being the Savior who offers to forgive us and make us God's people, so we can live with You and celebrate on that day You judge us all.
- C** Jesus, we know that we are all sinners. We have all disobeyed God's laws. We can never deserve to be God's people on our own. We need You to be our Savior!
- T** Thank You, Jesus, that we do not have to depend on our own goodness on the day You judge us. Thank You for dying on the cross to save all who turn away from their sins and trust in You as their Savior. Thank You that You will judge all who do according to Your perfect life, not their own. You have taken God's punishment in their place. They are forgiven. If we trust in You, we don't have to fear Your punishment on that day. We can look forward in excitement to life with You forever.
- S** Work in our hearts! Help us all to turn away from our sins and trust in You as our Savior. Help us to do good things with the gifts You have given us. Help us to love You and love others. Come back soon, Jesus! In Jesus' name we pray, Amen. In Jesus' name we pray, Amen.

Let's Sing Our Bible Verse!

Behold, Behold: Revelation 22:12-13

from *Deep Down Detectives* ESV Songs 16, track 18

Refrain:	To repay each one,
Behold, behold!	Repay each one for what he's done,
I'm coming soon!	To repay each one,
Bringing my recompense with me,	Repay each one for what he's done. <i>Refrain</i>
Behold, behold!	
I'm coming soon!	Revelation Twenty-two, twelve and thirteen.
Bringing my recompense with me.	

Go to the *Deep Down Detectives* Parent Resources for Unit 16 to get the Bible story and many more resources and songs for this unit at praisefactory.org

DDD BQ 16 BT 1 E2 Coloring Sheet/Take Home pg2

Which four of these clues belong in our story? Which two do not? Put an X in the boxes of the four that belong.

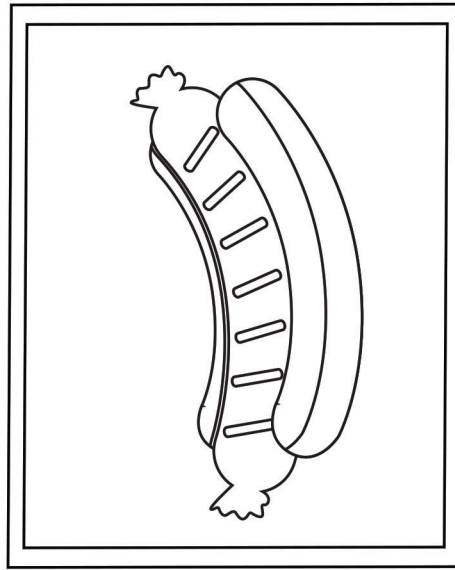
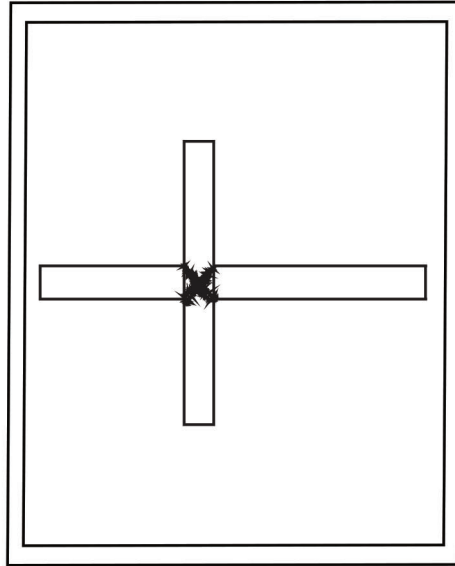
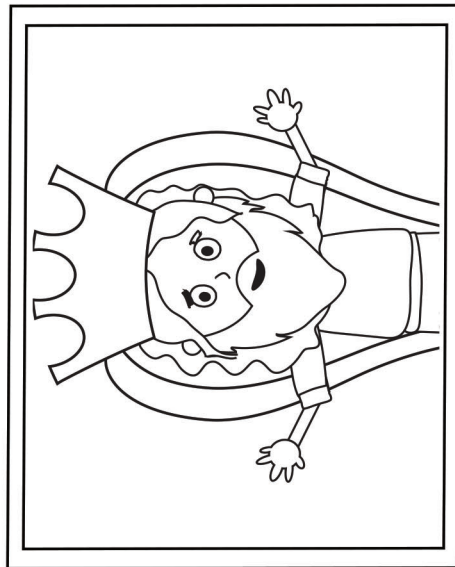
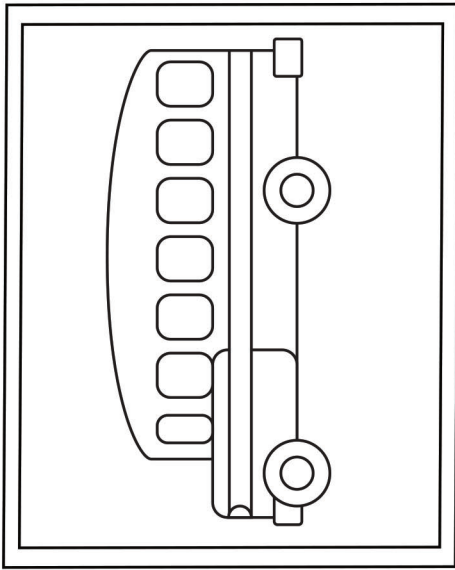
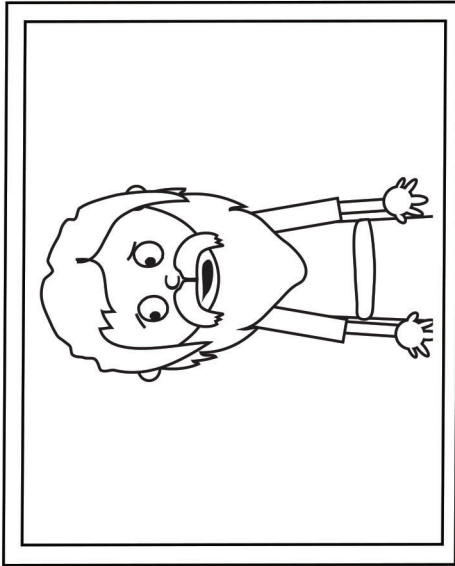
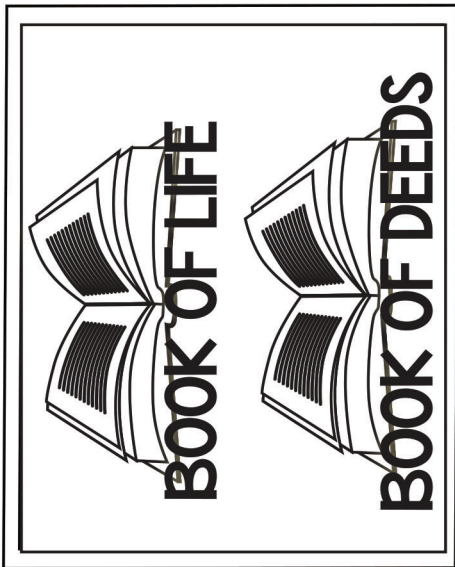

Deep Down Detective Devotion: Unit 16, Bible Truth 1, Lesson 3



Big Question 16: What Will Happen When Jesus Comes Back?

Answer: God Will Make Everything New... Jesus Will Judge All People Fairly!

Bible Truth 1 Meaning

When Jesus comes back, He will gather everyone who has ever lived before Him to be judged fairly. All the people who are alive when Jesus comes back, will stand before Him. All the people who were already dead will come out of the places they are buried and appeared before Him, too. Millions and millions, billions and billions of people. There will be more people than WE can know or count standing before Jesus on that day. But they will not be too many for Jesus. Jesus is God's Son. He knows every one of those people, inside and out. He knows their whole life. Yes, Jesus knows them all completely; and on that day, He will judge them all. What does it mean to judge? It means that Jesus will think fairly about what each person did with the life God gave them. Did they love God and serve Him? Did they love others? How did they use the good gifts God gave them? And most importantly, did they turn away from their sins and trust in Jesus as their Savior... or, did they refuse Him? It will be the saddest of days for all who refused to turn away from their sins and trust in Jesus as their Savior. The day for forgiveness and mercy will be over. Now, they will be separated from God and everything good forever. Satan and all the angels who rebelled against God will receive this final, terrible punishment, too. Oh, how I wish that everyone would turn away from their sins and trust in Jesus instead of receiving God's punishment! But what about God's people? How will Jesus fairly think about them? Didn't they disobey God, too? Shouldn't they be separated from God, too? Yes, they did disobey God, too. Yes, they deserve to be separated from God; but instead, they will receive wonderful, eternal life with God on that day! Why? Because they turned away from their sins and asked for God's forgiveness. They trusted in Jesus as their Savior, and He paid for their sins when He died on the cross. Because of Jesus, this will be a day of praise for them. Jesus will reward them for the good works they did in His name. And best of all, they will get to live happily with God in special closeness forever. We can be ready for that day, too, if we turn away from our sins and trust in Jesus as our Savior. This is how we become God's people.

How do I know this is true? The Bible tells me so!

"Behold, I am coming soon, bringing my recompense with me, to repay each one for what he has done. I am the Alpha and the Omega, the first and the last, the beginning and the end." -- Revelation 22:12-13, ESV

Some Questions for You

1. What did people think about Jesus? *They were amazed at how He taught about God and the great things He did by God's power.*
2. Who did the people think Jesus was? *Maybe John the Baptist or maybe one of the prophets--the special messengers of God.*
3. Who did Peter say Jesus was? *The Son of God, the Christ. The Forever King God had promised to send.*
4. What did Jesus tell Peter and others that He must do before He would rule as the Forever King? *Suffer and die on the cross, then be raised from the dead.*
5. What did Peter say when Jesus told them this? *That it should not be this way! Jesus was the Forever King. He should be worshiped, not suffer and die.*
6. What did Jesus tell Peter? *To stop saying this! To stop tempting Him to not follow God's good plan.*
7. What did Jesus say would happen when he returned as the Forever King? *He would gather all people together and judge them fairly. He would give out final punishments to all.*
8. What will happen to those who do not stop disobeying God and trust in Jesus as their Savior? *It will be a very sad day for them. They will face God's forever punishment for their sins.*
9. What will happen to those who DO turn away from disobeying God and trust in Jesus as their Savior? *They will be forgiven for their sins because of Jesus. They will get to live with God forever.*
10. How can we be ready for that great Day of Judgment? *We can turn away from disobeying God and trust in Jesus as our own Savior. This is how God forgives our sins and makes us His dearly-loved people, ready to stand before Him, because of what Jesus has done for us.*

Let's Pray!

- A** We praise You, Jesus, for being the good Judge who will give out fair rewards and punishments to all people at the end of time. We praise You for being the Savior who offers to forgive us and make us God's people, so we can live with You and celebrate on that day You judge us all.
- C** Jesus, we know that we are all sinners. We have all disobeyed God's laws. We can never deserve to be God's people on our own. We need You to be our Savior!
- T** Thank You, Jesus, that we do not have to depend on our own goodness on the day You judge us. Thank You for dying on the cross to save all who turn away from their sins and trust in You as their Savior. Thank You that You will judge all who do according to Your perfect life, not their own. You have taken God's punishment in their place. They are forgiven. If we trust in You, we don't have to fear Your punishment on that day. We can look forward in excitement to life with You forever.
- S** Work in our hearts! Help us all to turn away from our sins and trust in You as our Savior. Help us to do good things with the gifts You have given us. Help us to love You and love others. Come back soon, Jesus! In Jesus' name we pray, Amen.

Let's Praise God Right Now!

Big Q & A 16 Hymn: At the Name of Jesus

from *Deep Down Detectives ESV Songs 16, track 16*

Verse 4

Watch! for this Lord Jesus will come again,
With His Father's glory o'er the earth to reign,
For the day is coming when each knee shall bow,
So let hearts confess Him
King of glory now, King of glory now.
Words: adapted from Caroline M. Noel

Big Question 16 Praise Song: He Is Lord

from *Deep Down Detectives ESV Songs 16, track 17*

He is Lord, He is Lord!
He is risen from the dead and He is Lord!
Ev'ry knee shall bow,
Ev'ry tongue confess,
That Jesus Christ is Lord.

CAN YOU GUESS BIBLE TRUTH 2:
What Will Happen When Jesus
Comes Back?
God Will Make Everything New...

God's People Will

Happily with God Forever !

HINT: Where someone makes
their home? It starts with
an "I" and it rhymes with "give."

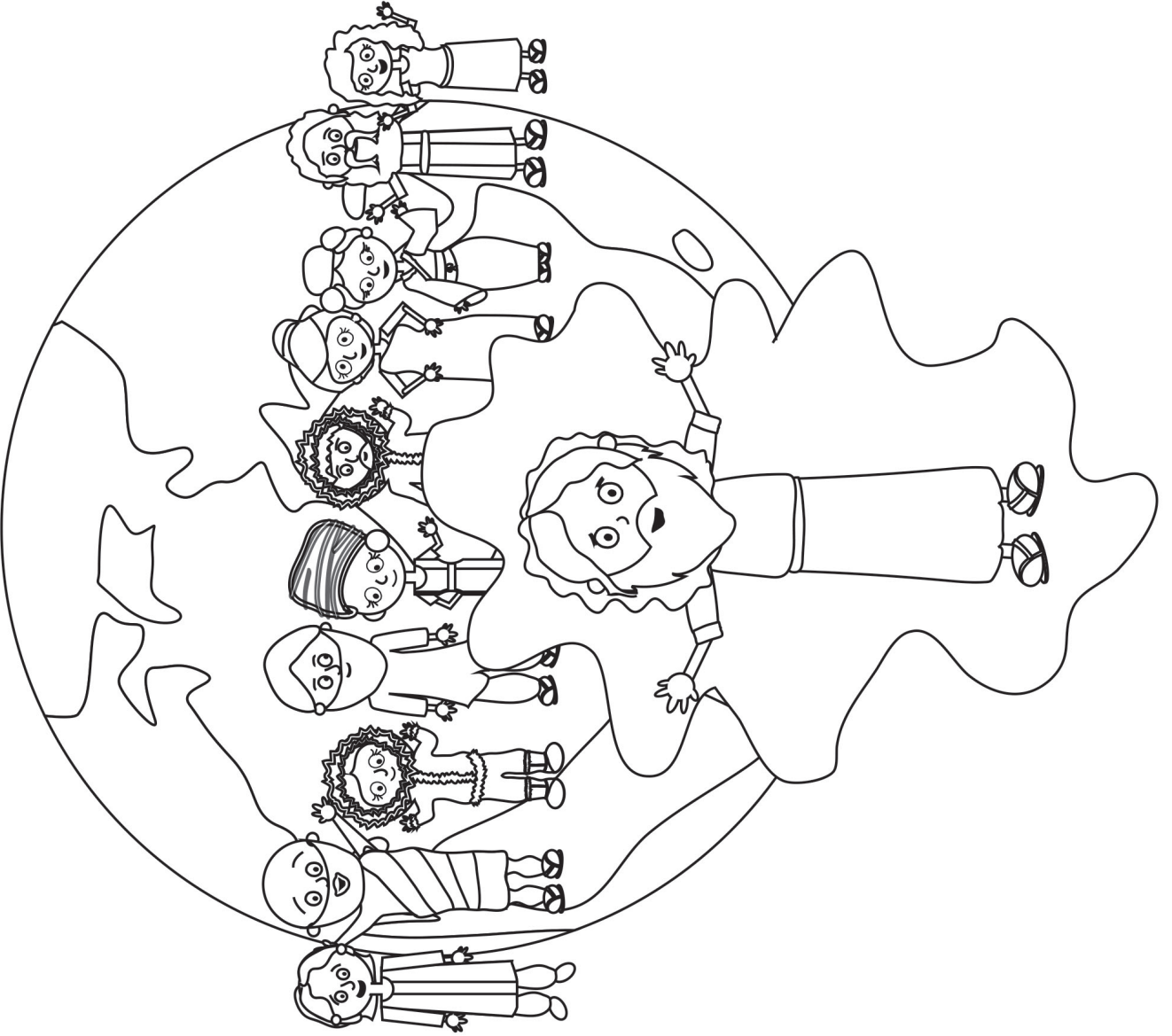

Deep Down Detective Devotion: Unit 16, Bible Truth 2, Lesson 1



Big Question 16: What Will Happen When Jesus Comes Back?

Answer: God Will Make Everything New... Jesus Will Judge All People Fairly!

Bible Truth 2 Meaning

Have you ever been to a wedding? If you have, perhaps you've watched how happy the bride (woman) and groom (man) are to get married. They love each other so much and love being together. They are so happy on their wedding day! It's the day they begin to live the rest of their lives together. The Bible says that Jesus is like a groom waiting for the day of His wedding. Not because He's going to get married to a woman, but because He is waiting to be joined forever with God's people, whom He loves so much. They are like a bride to Him. At the end of world, it will be like a wedding day for Jesus and God's people. That will be the day when, at last, Jesus and God's people start living together in the new heaven and earth, He's creating for them. There will be a great celebration called the Wedding Feast of the Lamb ("the Lamb" is a nickname for Jesus that reminds God's people that He died to save them). What a lot there will be to celebrate! Jesus will rule as king forever. All of God's people will love Him and obey Him all the time. There will never be any sadness or hurting or dying anymore. Best of all, God's people will be completely filled up with knowing and enjoying God and each other in a way that can only be described as Perfect Wonderfulness. And it will be like this forever and ever and ever. We can become God's people, too, when we turn away from our sins and trust in Jesus as our Savior.

How do I know this is true? The Bible tells me so!

"Hallelujah! For the Lord our God the Almighty reigns. Let us rejoice and exult and give him the glory, for the marriage of the Lamb has come, and his Bride has made herself ready." -- Revelation 19:6-7, ESV

Some Questions for You

1. Who is like a groom waiting for his wedding day? *Jesus is.*
2. Who is Jesus waiting to live with? *God's people, forever.*
3. Where will Jesus and God's people live together forever? *The new heaven and earth.*
4. What is the Wedding Feast of the Lamb? *The big celebration of God's people and Jesus living together forever.*
5. Who will rule as king forever? *God will.*
6. What will not be in the new heaven and earth? *Death, sadness, pain, anything evil.*
7. How long will God's people and Jesus live together happily? *Forever and ever.*
8. How can we become God's people? *By turning away from our sins and trusting in Jesus as our Savior*

Let's Pray!

- A** We praise You, Jesus! You are the great King who now rules over everything in heaven and will return one day. You will do away with sin, sadness, and death. You will be the great King over the new heaven and earth forever.
- C** Jesus, we know that we disobey You and all of God's good laws. We can never be good enough on our own to deserve to live with You when You return. We ask You to forgive us! Be our Savior, so we can be God's people and live with You forever.
- T** Thank You, Jesus, for coming to be our Savior! Thank You that we can be God's people when we turn away from our sins and trust in You as our Savior. Thank You for promising to get rid of sin, sadness, and death when You come back again. Thank You that You will create a perfect, new world for God's people to enjoy with You forever.
- S** Work in our hearts. Help us to turn away from our sins and trust in You, Jesus, as our Savior. Help us to love You and live for You today. Help us to look forward to the day when You come back and make all things new. Come back soon, Jesus!
In Jesus' name we pray, Amen.

Let's Sing about What We're Learning!

Go to the *Deep Down Detectives Parent Resources for Unit 16* to get the Bible story and many more resources and songs for this unit at praisefactory.org

Big Q & A 16 Song from *Deep Down Detectives ESV Songs 16, track 12*

(adapted version of (adapted version of "The Bear Went Over the Mountain))

What will happen when Jesus comes back?	God will make everything new,
What will happen when Jesus comes back?	God will make everything new.
What will happen when Jesus comes back?	What will happen when Jesus comes back?
God will make everything new.	What will happen when Jesus comes back?
	What will happen when Jesus comes back?
	God will make everything new.

Big Question 16 Action Rhyme Song from *Deep Down Detectives ESV Songs 16, track 13*

What will happen when Jesus comes back?
God will make everything new.

Refrain:

He'll make ev'rything new,
When He bursts through the blue.
No more sin, sickness, dying,
Only life, pure and good.
That's what will happen
When Jesus comes back!
Oh, Lord, come quickly,
Lord Jesus, come back!

Verse 1

What will happen when Jesus comes back?
This heav'n and earth will end, that's a fact!
God will destroy it, A perfect, new one
make.
The home of God with His people always.
Refrain

Verse 2

What will happen when Jesus comes back?
All God's enemies will get the sack!
Sin, sickness, death will all be defeated,
On the throne forever, Jesus be seated.
Refrain

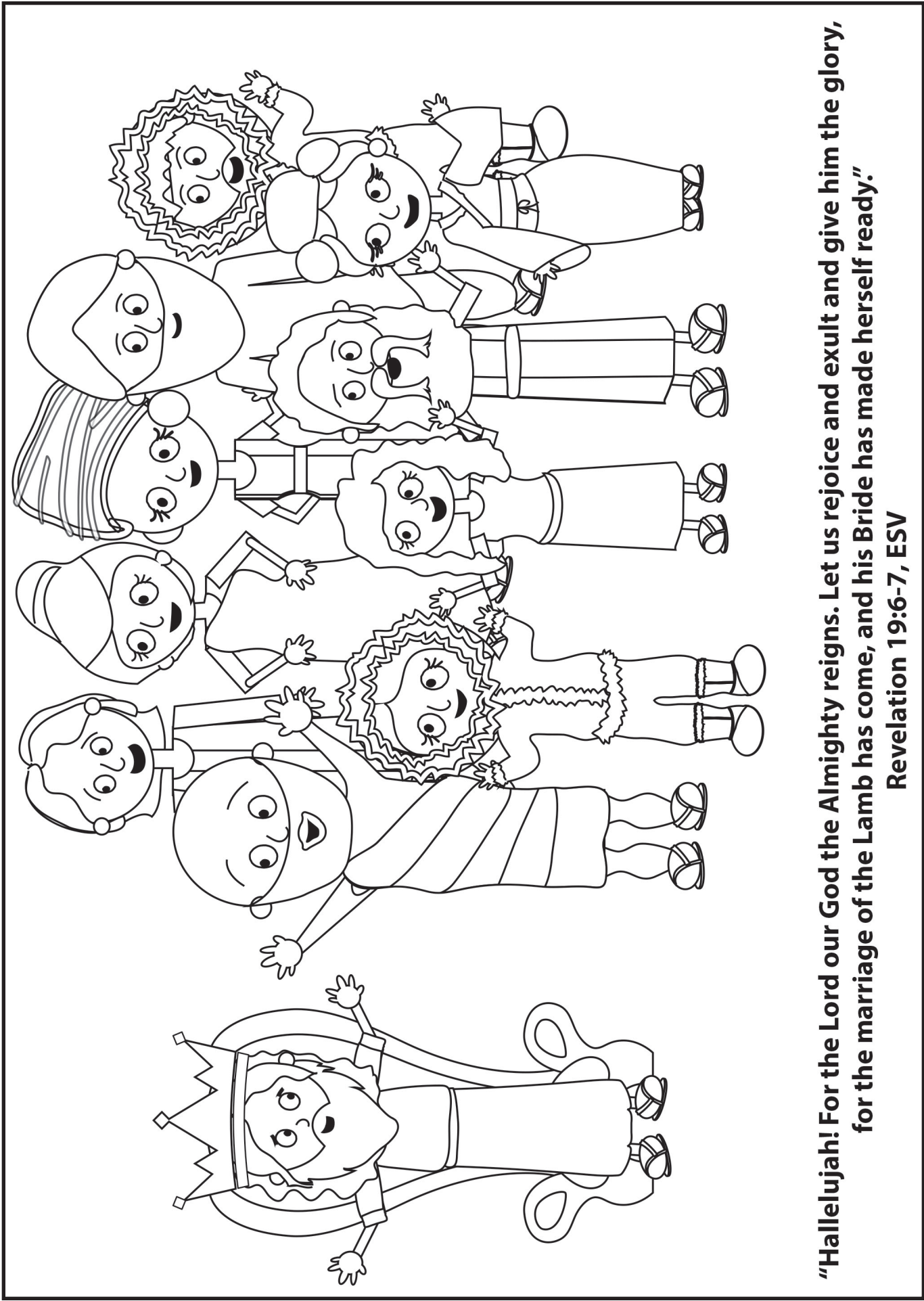

“Hallelujah! For the Lord our God the Almighty reigns. Let us rejoice and exult and give him the glory, for the marriage of the Lamb has come, and his Bride has made herself ready.”

Revelation 19:6-7, ESV

Deep Down Detective Devotion: Unit 16, Bible Truth 2, Lesson 2



Big Question 16: What Will Happen When Jesus Comes Back?

Answer: God Will Make Everything New... God's People Will Live Happily with God Forever!

How do I know this is true? The Bible tells me so:

"Hallelujah! For the Lord our God the Almighty reigns. Let us rejoice and exult and give him the glory, for the marriage of the Lamb has come, and his Bride has made herself ready." -- Revelation 19:6-7, ESV

Learn a Little: "Hallelujah! For the Lord our God the Almighty reigns."

Meaning:

This song is full of Bible words! "Hallelujah" is a Bible word that means "Praise the Lord." That's exactly what God's people will be doing when Jesus comes back to take them home to live with Him in the new heaven and earth forever! "The Lamb" is a nickname for Jesus, who died on the cross as the perfect payment for the sins of God's people. Jesus has given God's people the nickname of "His Bride." They are His special people who He loves so much and will be joined to them forever. How happy they will live together, forever and ever. They will rejoice with a big celebration! We can become God's people when we turn away from our sins and trust in Jesus as our Savior.

Some Questions for You

1. What does "hallelujah" mean? *It is a Bible word that means "Praise the LORD!"*
2. Why will God's people be praising the LORD at the end of time? *Because He will at last be their king and they will live with Him.*
3. What will life between Jesus and God's people like in heaven? *It will be happy like a bride and a groom who have just gotten married. They will be so happy to be living together at last! But it will be even better than that because Jesus will get rid of all sin and death. There will only be happiness and it will never, ever end.*
4. Who is "the Lamb" a nickname for? Why? *For Jesus. Lambs were used as a worship gift giving to God, long, long ago. Jesus gave up His life as the perfect worship gift and full payment for the sins of God's people. He was willing to die for their sins, so they could be God's people forever.*
5. How can we become God's people? *By turning away from our sins and trusting in Jesus as our Savior.*

Let's Pray!

- A** We praise You, Jesus! You are the great King who now rules over everything in heaven and will return one day. You will do away with sin, sadness, and death. You will be the great King over the new heaven and earth forever.
- C** Jesus, we know that we disobey You and all of God's good laws. We can never be good enough on our own to deserve to live with You when You return. We ask You to forgive us! Be our Savior, so we can be God's people and live with You forever.
- T** Thank You, Jesus, for coming to be our Savior! Thank You that we can be God's people when we turn away from our sins and trust in You as our Savior. Thank You for promising to get rid of sin, sadness, and death when You come back again. Thank You that You will create a perfect, new world for God's people to enjoy with You forever.
- S** Work in our hearts. Help us to turn away from our sins and trust in You, Jesus, as our Savior. Help us to love You and live for You today. Help us to look forward to the day when You come back and make all things new. Come back soon, Jesus! In Jesus' name we pray, Amen.

Let's Sing Our Bible Verse!

Hallelujah, Hallelujah! Revelation 19:6-7

from Deep Down Detectives ESV Songs 16, track 23

Hallelujah, hallelujah, the Lord, our God reigns,
Hallelujah, hallelujah,
The Lord our God, the Almighty reigns.

Let us rejoice and exult,
And give Him the glory,
For the marriage of the Lamb has come,
And his Bride has made herself ready.

Hallelujah, hallelujah, the Lord, our God reigns,
Hallelujah, hallelujah,
The Lord our God, the Almighty reigns.
Revelation Chapter Nineteen, verses six and seven.

Go to the *Deep Down Detectives Parent Resources for Unit 16* to get the Bible story and many more resources and songs for this unit at praisefactory.org

DDD BQ16 BT2 L2 Coloring Sheet/Take Home pg2

Which four of these clues belong in our story? Which two do not? Put an X in the boxes of the four that belong.

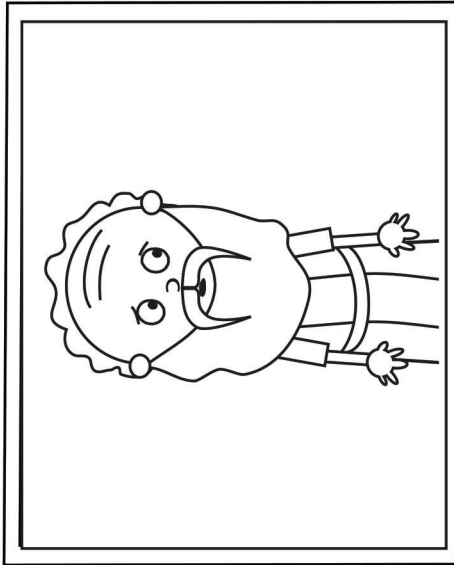

A Man Named Abraham

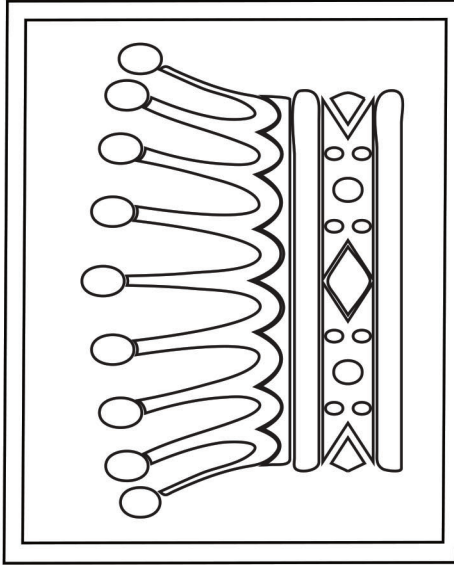

A Crown

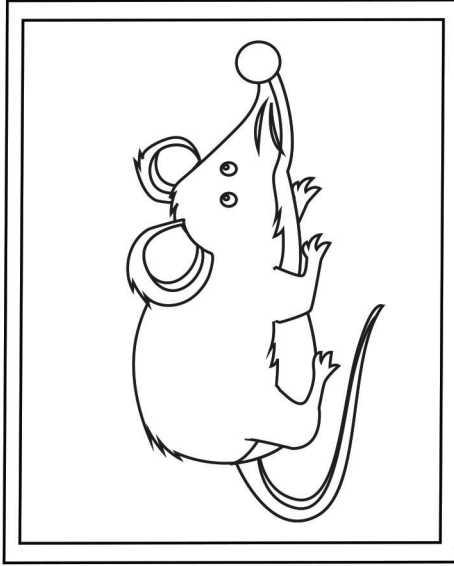

A Mouse

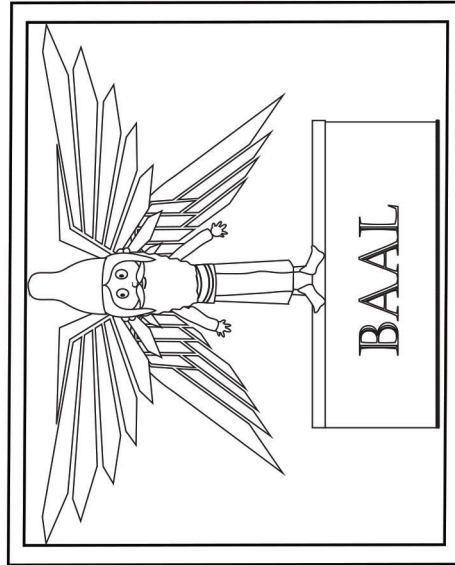

A Fake God

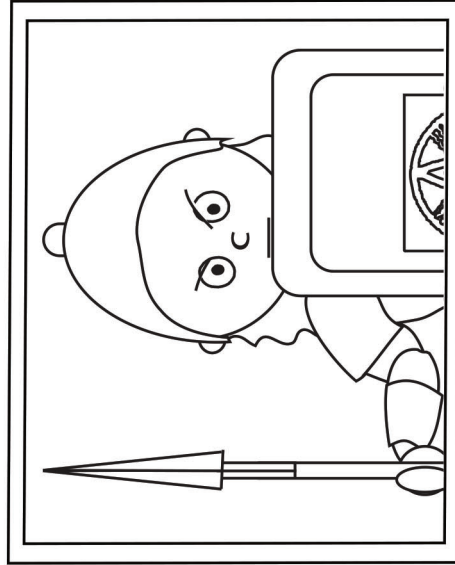

A Soldier

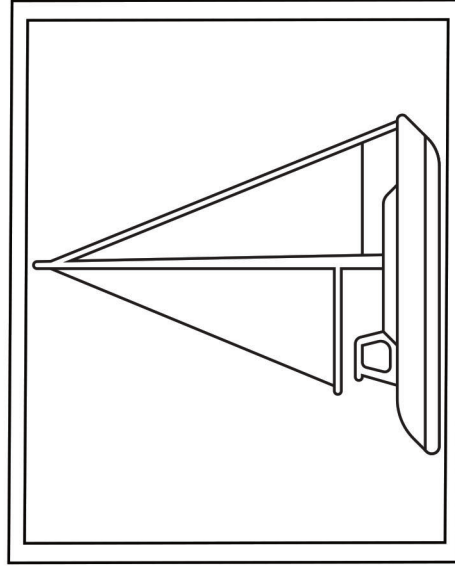

A Boat

Answer: Abraham, the crown, the fake god and the soldier belong. The mouse and the boat do not.

Deep Down Detective Devotion: Unit 16, Bible Truth 2, Lesson 3



Big Question 16: What Will Happen When Jesus Comes Back?

Answer: God Will Make Everything New... God's People Will Live Happily with God Forever!

Bible Truth 2 Meaning

Have you ever been to a wedding? If you have, perhaps you've watched how happy the bride (woman) and groom (man) are to get married. They love each other so much and love being together. They are so happy on their wedding day! It's the day they begin to live the rest of their lives together. The Bible says that Jesus is like a groom waiting for the day of His wedding. Not because He's going to get married to a woman, but because He is waiting to be joined forever with God's people, whom He loves so much. They are like a bride to Him. At the end of world, it will be like a wedding day for Jesus and God's people. That will be the day when, at last, Jesus and God's people start living together in the new heaven and earth, He's creating for them. There will be a great celebration called the Wedding Feast of the Lamb ("the Lamb" is a nickname for Jesus that reminds God's people that He died to save them). What a lot there will be to celebrate! Jesus will rule as king forever. All of God's people will love Him and obey Him all the time. There will never be any sadness or hurting or dying anymore. Best of all, God's people will be completely filled up with knowing and enjoying God and each other in a way that can only be described as Perfect Wonderfulness. And it will be like this forever and ever and ever. We can become God's people, too, when we turn away from our sins and trust in Jesus as our Savior.

How do I know this is true? The Bible tells me so!

"Hallelujah! For the Lord our God the Almighty reigns. Let us rejoice and exult and give him the glory, for the marriage of the Lamb has come, and his Bride has made herself ready." -- Revelation 19:6-7, ESV

Some Questions for You

1. What did the LORD promise God's people through Abraham? *That one of his sons would be a blessing to all the people of the world.*
2. What did the LORD promise God's people through David? *That one of his sons would rule as the Forever King.*
3. Had the people of Israel been faithful to the LORD, as they had promised Him? *No, they had not. Most of the time, they and their kings disobeyed Him. They deserved God's punishment, not these wonderful promises to be answered.*
4. Would the LORD still answer these promises, even though the people of Israel had been so sinful? *Yes, He would.*
5. Who was the son of Abraham who would come and bless all people? *Jesus. He would come to be the Savior for all people, from all places, who turn away from their sins and trust in Jesus as their Savior.*
6. Who was the Forever King, the son of David, who will come one day and bring God's Kingdom forever? *Jesus is. One day He will come back and get rid of all sin and death forever.*
7. What will the world be like when Jesus comes back? *God will make everything new. He will create a new heaven and earth. There will be no more sadness or death or disobeying God. He will live with His people forever and it will be so very, very wonderful.*
8. What can we do to be God's people and share life with God's great Forever King, Jesus? *We can turn away from disobeying God and trust in Jesus as our Savior.*

Let's Pray!

- A** We praise You, Jesus! You are the great King who now rules over everything in heaven and will return one day. You will do away with sin, sadness, and death. You will be the great King over the new heaven and earth forever.
- C** Jesus, we know that we disobey You and all of God's good laws. We can never be good enough on our own to deserve to live with You when You return. We ask You to forgive us! Be our Savior, so we can be God's people and live with You forever.
- T** Thank You, Jesus, for coming to be our Savior! Thank You that we can be God's people when we turn away from our sins and trust in You as our Savior. Thank You for promising to get rid of sin, sadness, and death when You come back again. Thank You that You will create a perfect, new world for God's people to enjoy with You forever.
- S** Work in our hearts. Help us to turn away from our sins and trust in You, Jesus, as our Savior. Help us to love You and live for You today. Help us to look forward to the day when You come back and make all things new. Come back soon, Jesus! In Jesus' name we pray, Amen.

Let's Praise God Right Now!

Big Q & A 16 Hymn: At the Name of Jesus

from *Deep Down Detectives* ESV Songs 16, track 16

Verse 4

Watch! for this Lord Jesus will come again,
With His Father's glory o'er the earth to reign,
For the day is coming when each knee shall bow,
So let hearts confess Him

King of glory now, King of glory now.

Words: adapted from Caroline M. Noel

Big Question 16 Praise Song: He Is Lord

from *Deep Down Detectives* ESV Songs 16, track 17

He is Lord, He is Lord!
He is risen from the dead and He is Lord!
Ev'ry knee shall bow,
Ev'ry tongue confess,
That Jesus Christ is Lord.

Go to the *Deep Down Detectives* Parent Resources for Unit 16 to get the Bible story and many more resources and songs for this unit at praisefactory.org