

DEEP DOWN DETECTIVES



Unit 15

Simple Story Scenes, ESV

God's People Gather Together



Curriculum for preschool and elementary age children,
training tools, music and other resources
are available for download or to order at:
www.praisefactory.org

© 2023 Praise Factory Media all rights reserved. May be reproduced by licensed user for classroom purposes only.

This and many other resources are available online at www.praisefactory.org

Scripture quotations marked (NIV) are taken from the Holy Bible, New International Version®, NIV®, Copyright © 1973, 1978, 1984 by Biblica, Inc.™ Used by permission of Zondervan. All rights reserved worldwide.www.zondervan.com

Scripture quotations marked (ESV) are from The Holy Bible, English Standard Version® (ESV®), copyright © 2001 by Crossway, a publishing ministry of Good News Publishers. Used by permission. All rights reserved.

Scripture quotations marked HCSB are taken from the Holman Christian Standard Bible®, Copyright © 1999, 2000, 2002, 2003, 2009 by Holman Bible Publishers. Used by permission. Holman Christian Standard Bible®, Holman CSB®, and HCSB® are federally registered trademarks of Holman Bible Publishers.

Table of Contents

About the Deep Down Detectives Visual Aids	5
Unit 15: God's People Gather Together	
Why Do God's People Go to Church? To Worship God and Love One Another!	
Bible Truth 1: By Praising God for Jesus' Win over Death	9
Bible Truth 1 Overview	11
Story Scenes	13
Bible Truth 2: By Learning from God's Word, the Bible	61
Bible Truth 2 Overview	63
Story Scenes	65
Bible Truth 3: By Caring for Each Other's Needs	117
Bible Truth 3 Overview	119
Story Scenes	121
Bible Truth 4: By Telling What God Has Done and Praying	177
Bible Truth 4 Overview	179
Story Scenes	181
Bible Truth 5: By Baptizing People Who Trust in and Live for Jesus	237
Bible Truth 5 Overview	239
Story Scenes	241
Bible Truth 6: By Remembering Jesus Died to Save Them	295
Bible Truth 6 Overview	297
Story Scenes	299
Take-Home Sheets	365
Bible Truth 1	367
Bible Truth 2	373
Bible Truth 3	379
Bible Truth 4	385
Bible Truth 5	391
Bible Truth 6	397

About the Deep Down Detectives Visual Aids

How Are They Used?



The Deep Down Detectives Visual Aids book is a companion resource to be used alongside the Deep Down Detectives Core Curriculum book for each unit. These colorful pictures are used in presenting the key concepts; telling the Bible stories; and, in playing the Bible Story Review games.

What Do They Include?



There are four, different resources included in this book:

1. Key Concept Visual Aids-- colorful signs of the Big Question and Answer, the Bible Truth, the Bible verse, and the Listening Assignments to use with the 3 lessons for each Bible Truth.

2. The Story Scenes. Notice that each scene is numbered and that there is a brief summary of the story that corresponds to the picture. You can actually just tell the story in a simple way by using only the text at the bottom of each Story Scene.

3. Take-Home Sheets for each Bible Truth.

4. Directions for making the Deep Down Detectives "Bible" Folder and the **back/front images** to paste in place when making it. (Larger back/front images are found online with the curriculum.)

Directions for how to make a homemade flannelgraph storyboard and sturdy Story Scene pictures are found in the back of this book.

Ready, Set, Rip It Out!

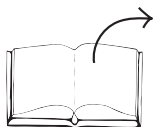

This book is meant to be ripped up and made into your visual aids. The key concept signs can be cut out and laminated or slipped into sheet protectors. The Story Scenes can be put in sheet protectors or laminated, too.

Store It!



Deep Down Detectives is a curriculum that can be used over and over. Store your visual aids and storyboard pictures after using them and they will serve you for many years. We store ours in manila envelopes and then put them (along with all the rest of the curriculum) in magazine files, labelled by Bible Truth. If you have multiple classes using the curriculum, store each set of resources in separate manila envelopes. This will make prep much simpler, second time around.

Replacement Story Scene Pictures



You can always purchase this book again or simply go online and print out any scenes that go missing.

Other Options

You can also choose to tell the story in a more traditional flannelgraph way by using your own flannelgraph figures or by purchasing/free downloading the Storyboard Pictures (large and small format size available). This is more complex and requires more preparation, but some love it. And, it does allow for kids to interact more by helping to place pictures up on the board as you tell the story.

Deep Down Detectives Curriculum Resources

There are five companion resources for each of the sixteen units of Deep Down Detectives. Use whichever resources are useful to your setting. Deep Down Detectives resources are available as free, digital downloads at praisefactory.org, or for purchase as hard copies through amazon.com.

Make sure to check out the “Bits and Pieces” section of the Deep Down Detectives curriculum online. It has all of the resources separated out making it easy for you simply to pick, choose and print out whatever you want.

Deep Down Detectives Core Curriculum Book, ESV/NIV for each unit

The Deep Down Detectives Core Curriculum book contains the curriculum introduction, the lesson plans, stories, music, activities and take home sheets for each of the units.

Deep Down Detectives Visual Aids with Simple Story Scenes, ESV/NIV for each unit

This resource provides large, colorful signs of the key concepts used in the unit, PLUS, easy-to-use, colorful scenes that you hold up in sequence as you tell the story. The story text for each scene is printed on the bottom of each scene.

Deep Down Detectives Simple Story Scenes, ESV/NIV for each volume

This resource includes only 2-page overview for Bible Truth, the story scenes, and take home sheets. This is a great, basic resource for use at home and in many classroom teaching situations.

Deep Down Detectives Small Format Visual Aids, ESV/NIV (Small Format Storyboard Pictures) for each volume

This resource provides large, colorful signs of the key concepts used in the unit, PLUS, colorful storyboard (flannelgraph) pictures to cut out and use as you tell each story. These storyboard pictures are for use with storyboards at least 24" x 36" in size.

Deep Down Detectives Large Format Visual Aids, ESV/NIV (Large Format Storyboard Pictures) for each volume

This resource provides large, colorful signs of the key concepts used in the unit. It also provides colorful storyboard (flannelgraph) pictures to cut out and use as you tell each story. These storyboard pictures are for use with storyboards 36" x 48" in size.

All of these materials may be photocopied for non-commercial church, classroom or school use by licensed users.

Other Resources in the Praise Factory Family of Curriculum

Deep Down Detectives is the second in a family of three, inter-related curriculums:

- Hide 'n' Seek Kids (focus group: ages 2-4; adaptable range: ages 2-pre-K 5's)
- Deep Down Detectives (focus group: ages 4--6's; adaptable range: ages 3-2nd grade)
- PFI: (focus group: grades K-5th grade; adaptable range: pre-K 5's-6th grade)

Each curriculum teaches the same biblical themes, but are presented in greater depth as the children grow and develop. Together, the curriculums work like an expanding spiral of truth that returns to reinforce the same truths with each curriculum, yet leading the children to deeper understanding with each step up.

Learn more about these curriculums as well as other resources and ideas for reaching children with the gospel at: www.praisefactory.org.

Unit 15: God's People Gather Together

UNIT OVERVIEW

A church is God's people gathering together. Some churches meet in special buildings. Some churches meet in homes. Some meet outside. No matter where they meet, when God's people gather together, they are a church. When God's people gather together as a church, they worship God. They worship Him for being the one, true God who is not like anyone else. They worship Him for saving them through Jesus. They sing songs and pray to God. They listen to the Bible and learn how to obey it. God's people also gather together to love one another. They talk with each other, and take care of each other, and pray for each other. The Bible tells us that God's people are to meet together often. It tells us that when they gather together, Jesus will be there with them in a special way. We can be God's people when we turn away from our sins and trust in Jesus as our Savior. Then, we will gather together with God's people to worship God and love one another, too!

UNIT BIBLE VERSE: Hebrews 10:24-25, ESV

"And let us consider how to stir up one another to love and good works, not neglecting to meet together."

BIG QUESTION UNDER INVESTIGATION: Why Do God's People Go to Church?

ANSWER: To Worship God and Love One Another!

OPTIONAL Big Question 15 INTRODUCTION LESSON (Use Hide 'n' Seek Kids Unit 15 Material)

Story: The Case of the People Who Loved a Lot *Acts*

Bible Verse: Hebrews 10:24-25, ESV

BIBLE TRUTH 1: By Praising God for Jesus' Win over Death (3 Lessons Available)

Story: The Case of the Third Day Yay

Exodus 16,20; Luke 22-24; Acts 20:7; 1 Corinthians 16:2

Bible Verse: 1 Peter 1:3, HCSB

BIBLE TRUTH 2: By Learning from God's Word, the Bible (3 Lessons Available)

The Case of the Faithful Leader" *Acts 16:1; 1 & 2 Timothy*

Bible Verse: 1 Timothy 4:13, ESV

BIBLE TRUTH 3: By Caring for Each Other's Needs

(3 Lessons Available)

Story: The Case of the Copycats *John 13-15, 18-20; Acts*

Bible Verse: John 13:34-35, ESV

BIBLE TRUTH 4: By Telling What God Has Done and Praying (3 Lessons Available)

Story: The Case of the Amazing Answer *Acts 12:1-18*

Bible Verse: Ephesians 6:18, NIV 1984

BIBLE TRUTH 5: By Baptizing People Who Trust in and Live for Jesus (3 Lessons Available)

Story: The Case of the Up and Down Sign *Matthew 28; Acts 1-2, 8:35-36, 10:47, 16:14-15,31-34*

Bible Verse: Acts 2:38-39, ESV

BIBLE TRUTH 6: By Remembering Jesus Died to Save Them (3 Lessons Available)

Story: The Case of the Remembered Rescue *Exodus 12; Luke 22; Isaiah 25:6-9*

Bible Verse: Luke 22:19,20, ESV

Deep Down Detectives ESV Songs 15 Track Numbers

This is a listing of all songs mentioned in the unit curriculum. You may or may not choose to use all of the songs. They are listed in easy-reference order--NOT in the order used in the curriculum. You may choose to simply burn a CD/load them onto an mp3 device in this order. Or, you may want to do what we do: choose the songs we want to use and create a play list of them in that order. Then, we burn a CD/upload the play list onto an mp3 device. A teacher only has to click forward to the next song, instead of hunting for the right track. The track number have been included as part of the title of each song, teachers will still have a reference to the track number listed in the curriculum (same as those listed below), even if you change the order on your customized play list.

SONGS USED EVERY UNIT OF THE CURRICULUM

- 1 The Classroom Song v.1
- 2 The Classroom Song v.2
- 3 The Classroom Song v.3
- 4 The Classroom Song v.4
- 5 Deep Down Detectives Theme Song
- 6 The Classroom Rules Song
- 7 Let's Pray Song
- 8 The Big Question Box Song
- 9 The Bible Chant Song
- 10 ACTS Prayer Song (Short Version)
- 11 ACTS Prayer Song (Full Version)

listen to or download songs for free at <https://praisefactory.org:Deep Down Detectives Music page>

Why the Extra Songs?

Deep Down Detectives is a curriculum used by a wide age-span of kids. Sometimes one of the other songs is a better fit for your kids. Or, you may simply want to teach them more songs on the same Bible Truth. Use as many or as few as you want.

UNIT 15: GOD'S PEOPLE GATHER TOGETHER

- 12 Big Q & A 15 Song
- 13 Big Question 15 Song: Why Do God's People Go to Church?
- 14 Big Question 15 Bible Verse Song: Stir Up Hebrews 10:24-25, ESV
- 15 Big Question 15 Hymn: Brethren, We Have Met to Worship, v.1
- 16 Big Question 15 Praise Song: Praise the Lord Together

Why Do God's People Go to Church? To Worship God and Love One Another...

Bible Truth 1: By Praising God for Jesus' Win over Death

- 17 Bible Verse: He Has Given Us a New Birth 1 Peter 1:3, HCSB
- 18 Extra Bible Verse: Shout with Joy to God Psalm 66:1-3,5,9,16, ESV
- 19 Extra Bible Verse: Make a Joyful Noise Psalm 100:1-6 ESV
- 20 Extra Bible Verse: Noise, Noise, Noise Psalm 100:1-4, ESV (other version)
- 21 Extra Bible Verse: The Time Is Fulfilled Mark 1:15, ESV
- 22 Extra Bible Verse: The Time Mark 1:15, ESV (other version)
- 23 Extra Bible Verse: How Beautiful Romans 10:13-15, ESV
- 24 Extra Bible Verse: Be My Witnesses Acts 1:8, ESV
- 25 Extra Bible Verse: All the Nations You Have Made Psalm 86:9, ESV
- 26 Extra Bible Verse: Behold a Great Multitude Revelation 7:9-10, ESV

Bible Truth 2: By Learning from God's Word, the Bible

- 27 Bible Verse: Devote Yourself 1 Timothy 4:13, ESV
- 28 Extra Bible Verse: An Overseer Must Be Titus 1:6-9, ESV
- 29 Extra Bible Verse: Open My Eyes Psalm 119:18,72-73, ESV
- 30 Extra Bible Verse: I Have Stored Up Your Word Psalm 119:11,15-16, ESV
- 31 Extra Bible Verse: If Anyone Loves Me John 14:23, ESV

Bible Truth 3: By Caring for Each Other's Needs

- 32 Bible Verse: A New Commandment John 13:34-35, ESV
- 33 Extra Bible Verse: There Are Different Kinds of Gifts 1 Corinthians 12:4,12,27, NIV 1984
- 34 Extra Bible Verse: As Each Has Received a Gift 1 Peter 4:10-11, ESV
- 35 Extra Bible Verse: Gift, Gift, Gift 1 Peter 4:10-11, ESV (other version)
- 36 Extra Bible Verse: Encourage One Another 1 Thessalonians 5:11,13-15, ESV
- 37 Extra Bible Verse: Build One Another Up 1 Thessalonians 5:11,13-15, ESV
- 38 Extra Bible Verse: Let Us Hold Fast Hebrew 10:23-25, ESV
- 39 Extra Bible Verse: On the First Day of Every Week 1 Corinthians 16:2, HCSB
- 40 Extra Bible Verse: An Overseer Must Be Titus 1:6-9, ESV
- 41 Extra Bible Verse: Love 1 Corinthians 13:4-8,13, ESV
- 42 Extra Bible Verse: Love Is Patient 1 Corinthians 13:4-8, ESV

Bible Truth 4: By Telling What God Has Done and Praying

- 43 Bible Verse: Pray, Pray, Pray Ephesians 6:18, HCSB
- 44 Extra Bible Verse: Take Up the Whole Armor Ephesians 6:13,16-18, ESV
- 45 Extra Bible Verse: Help Us 2 Corinthians 1:13, ESV

Bible Truth 5: By Baptizing People Who Trust in and Live for Jesus

- 46 Bible Verse: Repent, Repent and Be Baptized Acts 2:38-39, ESV
- 47 Extra Bible Verse: The Time Is Fulfilled Mark 1:15, ESV
- 48 Extra Bible Verse: The Time Mark 1:15, ESV (other version)

Bible Truth 6: By Remembering Jesus Died to Save Them

- 49 Bible Verse: This Is My Body Luke 22:19,20, ESV
- 50 Extra Bible Verse: He Took Bread Luke 22:19,20, HCSB

DEEP DOWN DETECTIVES



Simple Story Scenes

Unit 15,

Bible Truth 1

Using Simple Story Scenes as a Curriculum

Introduce the Key Concept and Bible Verse

Simple Story Scenes give you the basics for the core of your lesson. You can use the overview sheet to introduce and explain the key concept and Bible verse.

Give the Case Assignment

Give the children a Detective Dan listening assignment. Two are provided. You can add a third using the ideas on the bonus, third take-home sheet, if desired. Each listening assignment, let's you teach the story with a different learning emphasis.

Show & Tell the Story

Hold up the pictures and tell the story from the story scenes. Alternatively, you can find in the and Pieces section for this unit at praisefactory.org, these same listening assignments and story scenes, gospel and ACTS prayer modified for view on a screen. Simply download them or open them online and show through your own monitor (tablet, big screen, whatever).

Solve the Case

Repeat Detective Dan's listening assignment question and discuss the answer.

Share the Gospel

Share the gospel tie-in with the kids.

Close in ACTS Prayer

Pray the ACTS prayer with the kids. If using the curriculum with older children, give them a chance to think up their own ACTS tie-ins to the story, using the one provided as cues/ideas for you.

Review Time

Give out the take-home sheet (there are three: two that correlates to the two Detective Dan assignments in the Story Scenes, and a bonus third one.) As the children are coloring, use the take-home sheet discussion questions or your own questions to further review and apply the key concepts, Bible verse, and story truths to the children.

Looking for more?

Online, in the Bits and Pieces section for this unit, you will find review games, crafts, storyboard flannelgraph figures, and audio and sheet music for all of the songs. There are also full lesson plans that offer more of a script and take this curriculum's possibilities to much more depth. Don't forget to tell the parents about the Parents Resources section where they can read through the Story scenes and download take homes with their kids.

Unit 15: God's People Gather Together**Unit Big Question (and Answer):** Why Do God's People Go to Church?

To Worship God and Love One Another!

Unit Bible Verse: "And let us consider how to stir up one another to love and good works, not neglecting to meet together." Hebrews 10:24-25, ESV**Bible Truth 1 Concept: To Worship God and Love One Another...
By Praising God for Jesus' Win over Death!**

On one sad Friday, Jesus suffered and died on the cross for God's people. He was buried in a grave, but He didn't stay there. He rose up from the grave on Day Three—Sunday! He was alive and would be forevermore!

Ever since that first and best Sunday when Jesus beat sin and death, God's people have been gathering together each week to celebrate. (The big, Bible word for God's people gathered together is "congregation.") They sing and pray and listen to God's Word. They rejoice that Jesus had beaten sin and death for them. They are happy the Holy Spirit lives in their hearts. They look forward to the day when Jesus will come back and all of God's people will at last gather together forever as one, big family. That will be the biggest and best celebration of all!

Now all who turn away from their sins and trust in Jesus as their Savior receive God's forgiveness for their sins. He sends His Holy Spirit to live in their hearts and helps them love God and live for Him the rest of their lives. Forever they will be God's dearly-loved people! What an amazing gift God has given us through Jesus!

God's people love to celebrate together, but they are always hoping for more to join them. That's why they tell their neighbors nearby the good news of Jesus. (The big, Bible word for telling others about Jesus is "evangelism.") And that's why they even travel to faraway lands to tell people there about Jesus, too. (The big, Bible word for going to another land to tell people about Jesus is "missions.") They want everyone to hear the good news of Jesus, repent of their sins and trust in Jesus as their Savior. (The big, Bible word for the good news of Jesus is "the gospel.") They want them all to become God's people and join the Sunday celebration of what God has done through Jesus! We can be God's people, too, when we turn away from our sins and trust in Jesus as our Savior. Sundays will be our celebration day, too!

Bible Truth 1 Bible Verse: 1 Peter 1:3, HCSB

"He has given us a new birth into a living hope through the resurrection of Jesus Christ from the dead."

Learn a Little: He has given us a new birth through the resurrection of Jesus Christ from the dead."**Meaning**

When we are born as babies, we have our first birth. But did you know that all who turn away from their sins and trust in Jesus as their Savior are given a new birth? Not a new birth as a baby again. This isn't a new birth for our bodies. God gives our heart a new birth. He forgives all our sins and gives us a new heart filled with the Holy Spirit --a heart that knows God, and wants to love Him and live for Him.

Jesus is why God's people get to have this wonderful new birth. He died on the cross for their sins. He made the way for them to be God's people. But Jesus didn't stay dead. He was resurrected. (That's a big Bible word meaning that He rose from the dead.) Yes, on that third day--that glorious Easter Sunday morning-- He rose from the dead, showing that He had really beaten sin and death for them. Jesus is alive for evermore. And He is the living hope of God's people that one day, they, too, will live face to face with God forever! We can be God's people when we turn away from our sins and trust in Jesus as our Savior.

Bible Truth 1 ACTS Prayer

- A** We praise You, God, for saving Your people, the Church. We praise You for being so powerful that You beat sin and death for them.
- C** God, we know that Sunday should be a special celebration day. It's the day Jesus rose from the dead. But sometimes, we would rather not go to church and celebrate. We would rather do something else that seems more fun. We don't treasure what Jesus did on the cross. We need a Savior!
- T** God, thank You for beating sin and death for God's people through Jesus. Thank You that they don't have to face Your punishment for sin. They get to know You in their hearts now, and get to live with You in heaven when they die. Thank You that we can be Your people, too, when we turn away from our sins and trust in Jesus as our Savior.
- S** God, work in our hearts. Help us to turn away from our sins and trust in Jesus as our Savior. Help us to celebrate Jesus' win over sin and death as we gather together with God's people at church.

In Jesus' name we pray, Amen.

Bible Truth 1 Story**The Case of the Third Day Yay**

Exodus 16:20; Luke 22-24; Acts 20:7; 1 Corinthians 16:2

Songs Used in Bible Truth 1

Big Q & A 15 Song

Big Question 15 Song: Why Do God's People Go to Church?

Big Question 15 Bible Verse Song: Stir Up Hebrews 10:24-25, ESV

Big Question 15 Hymn: Brethren, We Have Met to Worship, v.1

Big Question 15 Praise Song: Praise the Lord Together

Bible Truth 1 Bible Verse: He Has Given Us a New Birth 1 Peter 1:3, HCSB

Extra Bible Verse: Shout with Joy to God Psalm 66:1-3,5,9,16, ESV

Extra Bible Verse: Make a Joyful Noise Psalm 100:1-6 ESV

Extra Bible Verse: Noise, Noise, Noise Psalm 100:1-4. ESV (other version)

Extra Bible Verse: The Time Is Fulfilled Mark 1:15, ESV

Extra Bible Verse: The Time Mark 1:15, ESV (other version)

Extra Bible Verse: How Beautiful Romans 10:13-15, ESV

Extra Bible Verse: Be My Witnesses Acts 1:8, ESV

Extra Bible Verse: All the Nations You Have Made Psalm 86:9, ESV

Extra Bible Verse: Behold a Great Multitude Revelation 7:9-10, ESV

listen to or download songs for free at <https://praisefactory.org>: Deep Down Detectives Music page

“The Case of the Third Day Yay”

Exodus 16:20; Luke 22-24; Acts 20:7; 1 Corinthians 16:2



Detective Dan's Listening Assignment #1

1. What happened on the third day after Jesus died that made the disciples so happy?
2. What day of the week was that third day? What did Jesus' followers keep doing each week to remember that first, wonderful day?



Detective Dan's Listening Assignment #2

1 Peter 1:3, HCSB

“He has given us a new birth into a living hope through the resurrection of Jesus Christ from the dead.”

1. Who celebrated Jesus' resurrection from the dead on that first, wonderful Sunday?
2. How did they receive a new birth into a living hope? What did that mean?

(more listening and discussion questions are included in the curriculum at praisefactory.org)

I. Walk! Walk! Walk! Look at all of God's people walking.

Where are they going? What are they doing? They aren't staying at home, so where are they going?

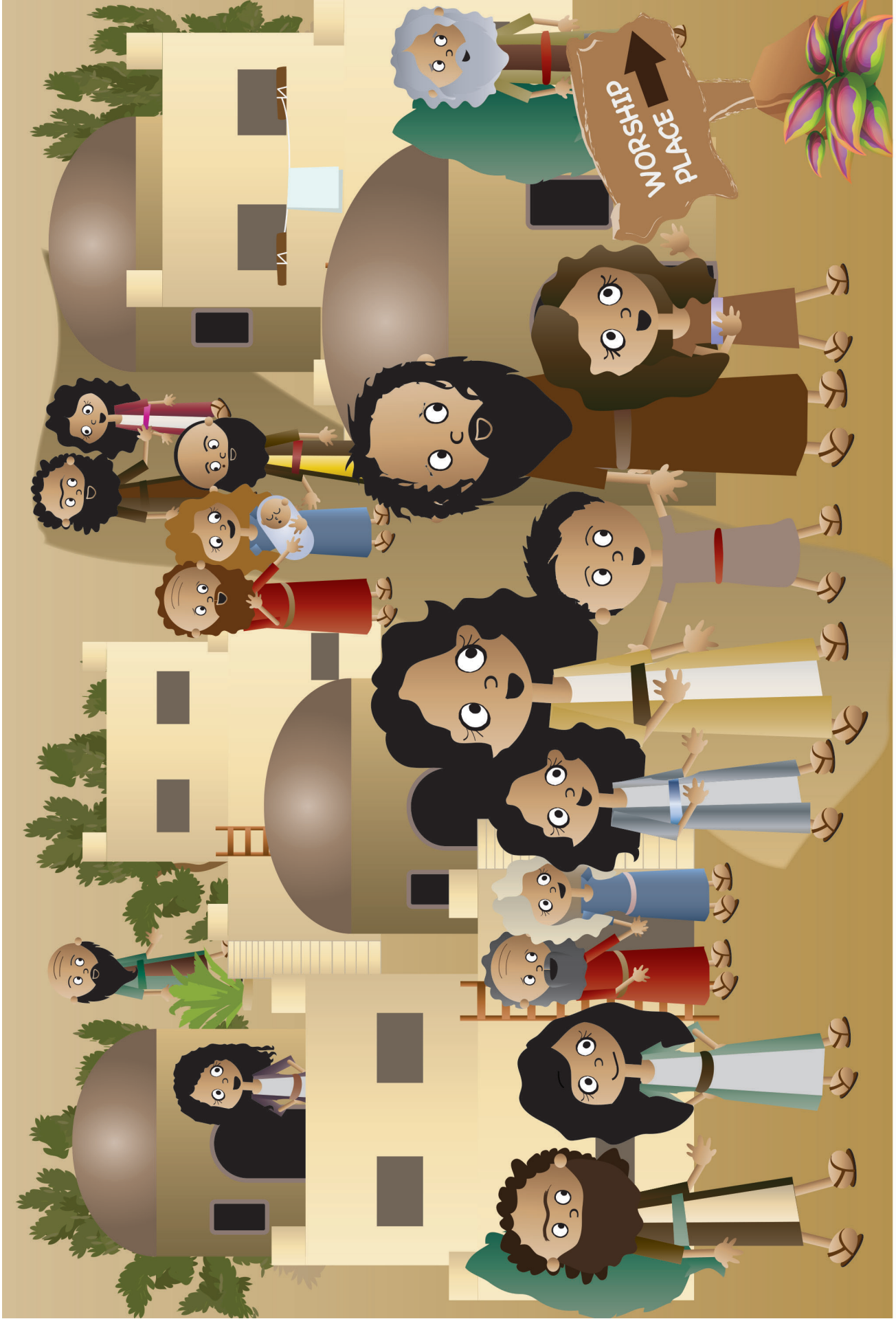

I. Walk! Walk! Look at all of God's people walking! Where are they going? What are they doing? They aren't staying at home, so where are they going?

2. Are they going to the market to shop? No, not the market. Are they going to the fields to work? No, not this day.

Then, where ARE they going? Aren't those the places they go every day? Aren't those the things they do every day: Sunday, Monday, Tuesday, Wednesday, Thursday, Friday, and Saturday?



2. Are they going to the market to shop? No, not the market. Are they going to the fields to work? No, not this day. Then, where ARE they going? Aren't those the places they go every day? Aren't those the things they do every day: Sunday, Monday, Tuesday, Wednesday, Thursday, Friday, and Saturday?

3. Well, not quite every day. There was one day, each week, that God told them to do something very different.

On this day, they were to rest. And, instead of going about their regular work, they were to go to the worship place. This was the day they were to gather together and worship the LORD.

Do you know what this special day was called? It was called the Sabbath --from the Hebrew word for "rest." And which day of the week was the Sabbath? It was Saturday, always Saturday --the last day of the week.



3. Well, not quite every day. There was one day, each week, that God told them to do something very different. On this day, they were to rest. And, instead of going about their regular work, they were to go to the worship place. This was the day they were to gather together and worship the LORD. Do you know what this special day was called? It was called the Sabbath --from the Hebrew word for "rest." And which day of the week was the Sabbath? It was Saturday, always Saturday --the last day of the week.

4. That's why, in our story, God's people weren't staying at home, or going to shop at the market, or going to work in the fields on this day.

This was the Sabbath Day, and God's people were going to worship God, as God told them to in the Ten, Big Laws He gave them through Moses.



4. That's why, in our story, God's people weren't staying at home, or going to shop at the market, or going to work in the fields on this day. This was the Sabbath Day, and God's people were going to worship God, as God told them to in the Ten, Big Laws He gave them through Moses.

5. For hundreds and hundreds of years, the Sabbath-Saturday was the day God's people were to rest from their work, and to gather together to worship God.

But then, something really big and wonderful happened: the Savior came. And something He did changed that worship day from Saturday to Sunday. Do you know the Savior's name? It's Jesus!



5. For hundreds and hundreds of years, the Sabbath-Saturday was the day God's people were to rest from their work, and to gather together to worship God. But then, something really big and wonderful happened: the Savior came. And something He did changed that worship day from Saturday to Sunday. Do you know the Savior's name? It's Jesus!

6. Yes, Jesus came to earth to be the Savior of God's people.

He lived a perfect life. He never, ever disobeyed God. He was the perfect law-keeper of all of God's laws. Then, Jesus gave His perfect life as the full payment for the sins of God's people, when He suffered and died on the cross.



6. Yes, Jesus came to earth to be the Savior of God's people. He lived a perfect life. He never, ever disobeyed God. He was the perfect law-keeper of all of God's laws. Then, Jesus gave His perfect life as the full payment for the sins of God's people, when He suffered and died on the cross.

7. Friends came and took Jesus' body off the cross. They covered it in sweet-smelling spices and wound white, linen cloth around it. They buried Jesus' body in a grave cave, rolled a huge stone in place to shut the cave, and left Him. Oh, how sad they were on that Friday when Jesus died!

In that grave cave, Jesus' dead body lay all that Friday and all that Sabbath-Saturday. Soldiers stood guard over the grave cave, making sure no one came and took Jesus body.

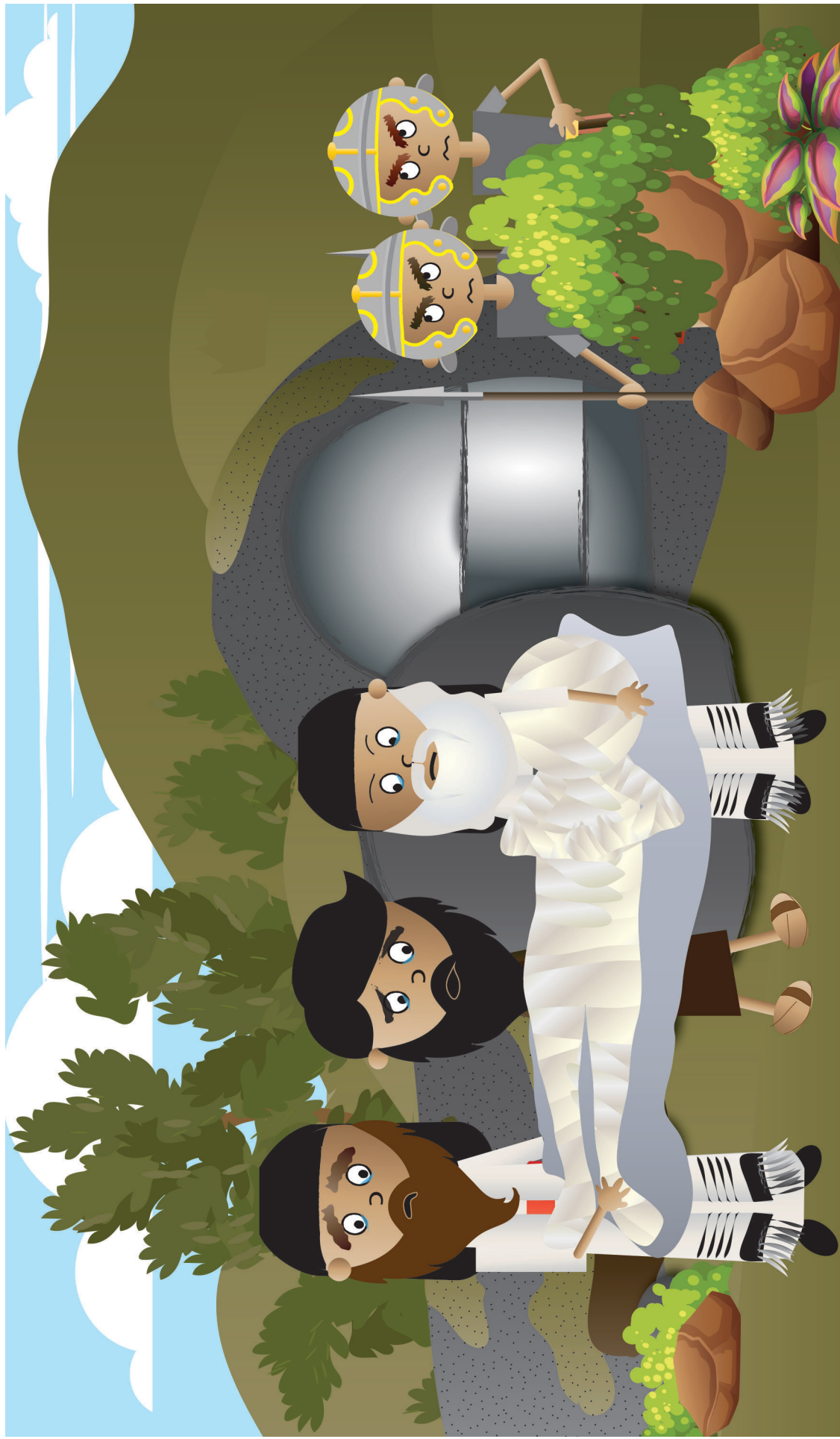

7. Friends came and took Jesus' body off the cross. They covered it in sweet-smelling spices and wound white, linen cloth around it. They buried Jesus' body in a grave cave, rolled a huge stone in place to shut the cave, and left Him. Oh, how sad they were on that Friday when Jesus died!

In that grave cave, Jesus' dead body lay all that Friday and all that Sabbath-Saturday. Soldiers stood guard over the grave cave, making sure no one came and took Jesus body.

8. But then, early on the next day---Sunday---what a surprise there was for those soldiers and Jesus' disciples ...and really the whole world!

Jesus' body didn't stay put AT ALL! Can you tell me what happened? God raised Jesus from the dead! Out of that grave cave, Jesus came. He was alive, never to die again!



8. But then, early on the next day--Sunday--what a surprise there was for those soldiers and Jesus' disciples ...and really the whole world! Jesus' body didn't stay put AT ALL! Can you tell me what happened? God raised Jesus from the dead! Out of that grave cave, Jesus came. He was alive, never to die again!

9. Jesus appeared to many people that day.

He appeared to three women who had come to His grave cave.

Yay! Jesus is alive! Then, to two people as they walked along the road to their home. “Yay! Jesus is alive!”



9. Jesus appeared to many people that day. He appeared to three women who had come to His grave cave. Yay! Jesus is alive! Then, to two people as they walked along the road to their home. "Yay! Jesus is alive!"

10. And at the end of the day, Jesus appeared to a whole group of His disciples.

“Yay! Jesus is alive!” Yes! Jesus was alive, and His friends were so happy! Jesus had really beaten sin and death for God’s people. Now, instead of facing God’s punishment, God’s people were forgiven! They would get to know God, and love and enjoy Him forever!



10. And at the end of the day, Jesus appeared to a whole group of His disciples. "Yay! Jesus is alive!" Yes! Jesus was alive, and His friends were so happy! Jesus had really beaten sin and death for God's people. Now, instead of facing God's punishment, God's people were forgiven! They would get to know God, and love and enjoy Him forever!

II. What an amazing day this was! This was the day God's people had been waiting for since the beginning, when Adam and Eve disobeyed God and sin came into the world.

Jesus' followers never wanted to forget this wonderful Sunday. So, they began to gather together every Sunday to celebrate what He had done for them.

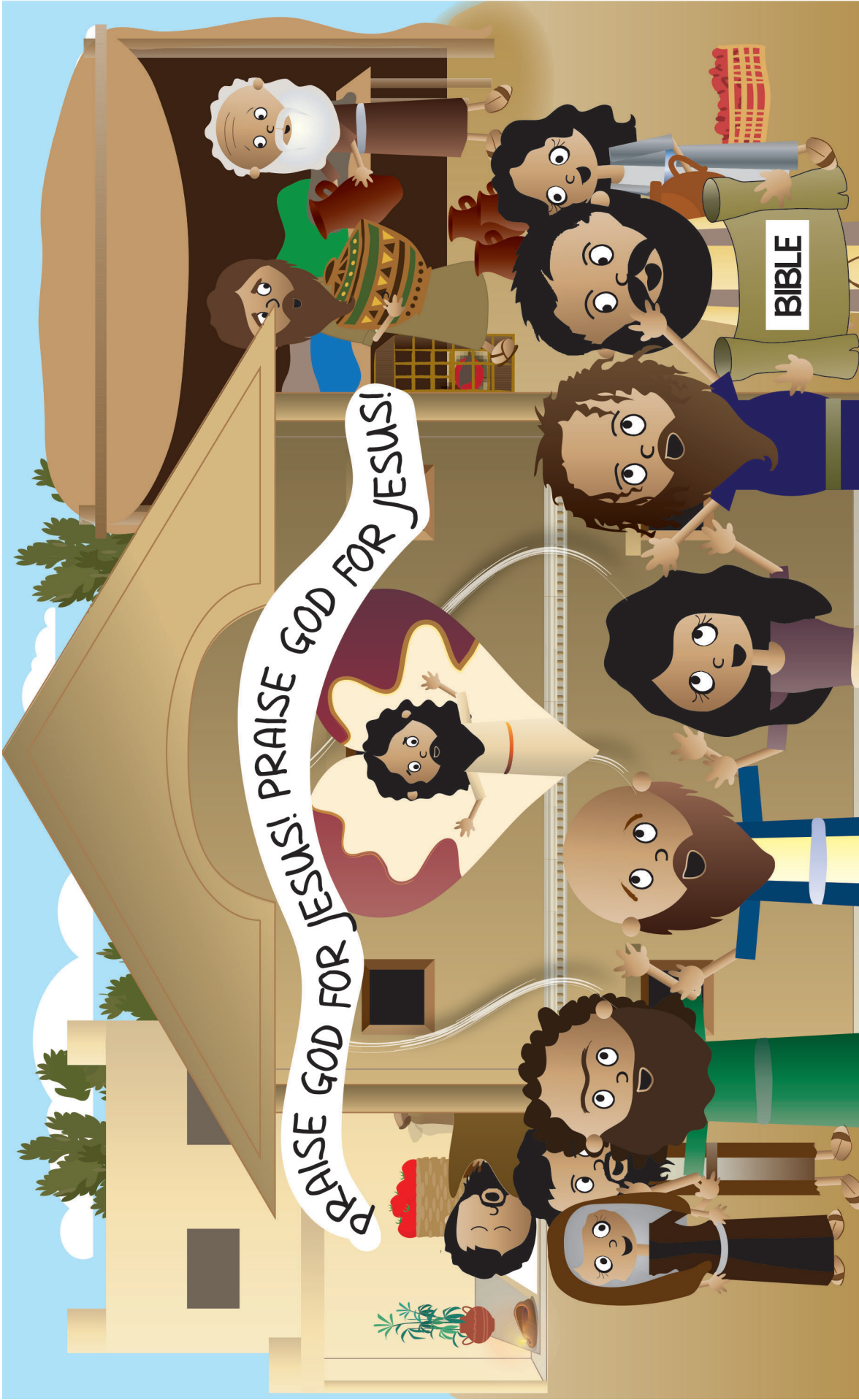

II. What an amazing day this was! This was the day God's people had been waiting for since the beginning, when Adam and Eve disobeyed God and sin came into the world. Jesus' followers never wanted to forget this wonderful Sunday. So, they began to gather together every Sunday to celebrate what He had done for them.

12. They didn't call this special worship day the Sabbath anymore. They gave it a new name to remind them of what Jesus had done. Do you know what that new name is?

They called it "the Lord's Day" because they were celebrating the wonderful Sunday the Lord Jesus rose from the dead.



12. They didn't call this special worship day the Sabbath anymore. They gave it a new name to remind them of what Jesus had done. Do you know what that new name is? They called it "the Lord's Day" because they were celebrating the wonderful Sunday the Lord Jesus rose from the dead.

13. From then on, Jesus' followers kept on gathering together every Lord's Day to worship God and love one another.

They worshiped God and praised Jesus, their Savior, who beat sin and death for them. They shared stories of the amazing things that God was doing, and asked God to do more.



13. From then on, Jesus' followers kept on gathering together every Lord's Day to worship God and love one another. They worshiped God and praised Jesus, their Savior, who beat sin and death for them. They shared stories of the amazing things that God was doing, and asked God to do more.

14. They learned from God's Word, the Bible, and shared a special meal together to remember that Jesus died for their sins.



H. They learned from God's Word, the Bible, and shared a special meal together to remember that Jesus died for their sins.

15. They prayed and care for each other's needs. In all these ways, they worshipped God and loved one another. How loud were their praises every Lord's Day! Sunday was a big celebration day!

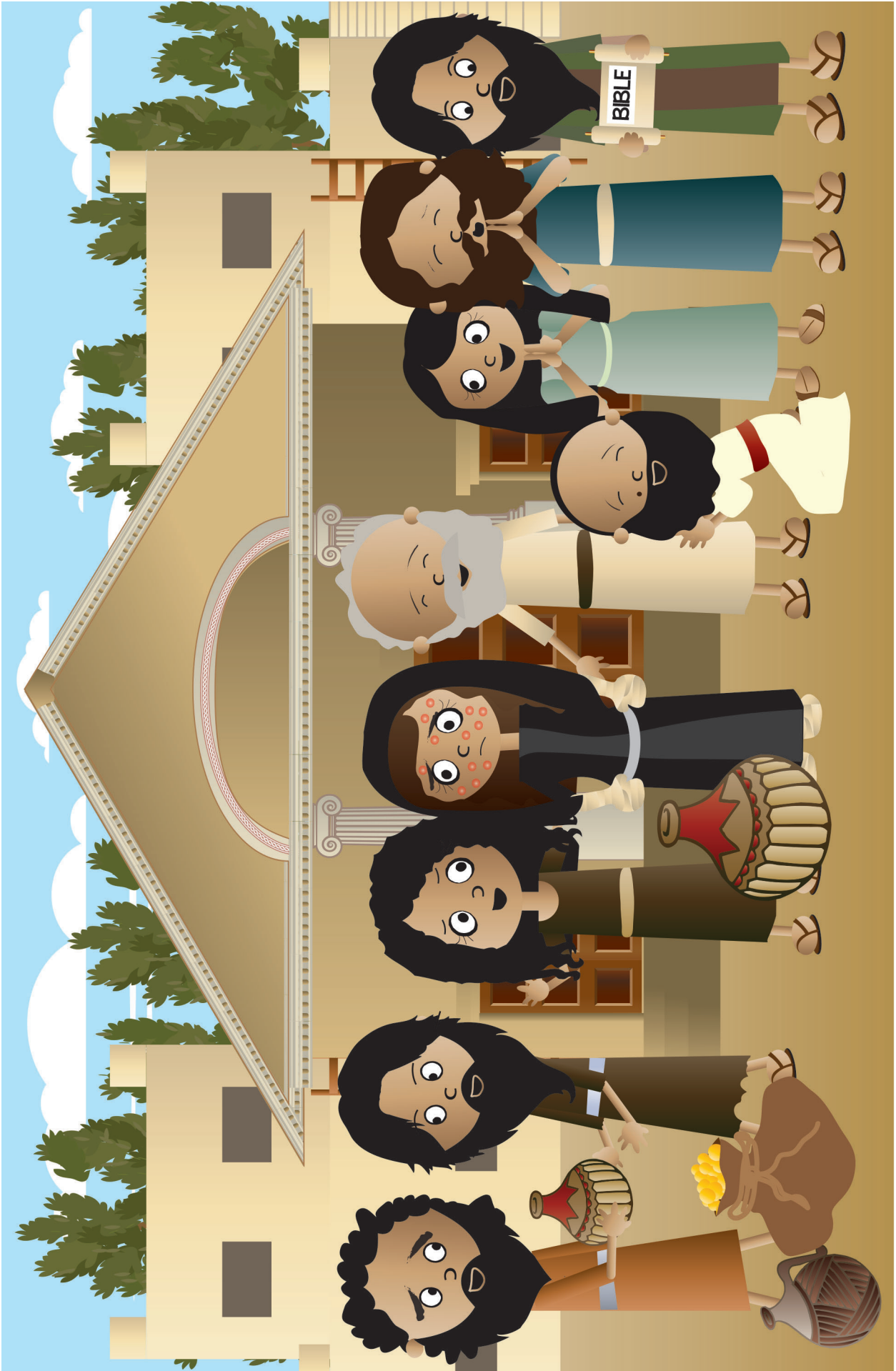

15. They prayed and care for each other's needs. In all these ways, they worshipped God and loved one another. How loud were their praises every Lord's Day! Sunday was a big celebration day!

16. But as happy as those first Christians were to celebrate every Sunday in their little gatherings, that wasn't enough. Not enough for them and not enough for God. They wanted more, more, more! Can you guess what they wanted more of?

They wanted MORE people to know the good news of Jesus. They wanted MORE people to turn away from their sins and trust in Him as their Savior. They wanted MORE people to know God, love God, and sing praises to Him. They wanted the WHOLE WORLD to be filled with God's people.

God's Son, Jesus, the Savior



16. But as happy as those first Christians were to celebrate every Sunday in their little gatherings, that wasn't enough. Not enough for them and not enough for God. They wanted more, more, more! Can you guess what they wanted more of? They wanted MORE people to know the good news of Jesus. They wanted MORE people to turn away from their sins and trust in Him as their Savior. They wanted MORE people to know God, love God, and sing praises to Him. They wanted the **WHOLE WORLD** to be filled with God's people.

17. This was what Jesus had told them to do.

“Go into the whole world with the gospel,” Jesus had said, right before He went up to heaven. “Teach them to repent of their sins and trust in Me as their Savior. Baptize them as My followers. Teach them how to be My disciples. Teach them how to live as God’s people,” He said. “I will send the Holy Spirit to help you,” Jesus promised.



17. This was what Jesus had told them to do. "Go into the whole world with the gospel," Jesus had said, right before He went up to heaven. "Teach them to repent of their sins and trust in Me as their Savior. Baptize them as My followers. Teach them how to be My disciples. Teach them how to live as God's people," He said. "I will send the Holy Spirit to help you," Jesus promised.

18. And that's just what Jesus' disciples did.

After the Holy Spirit came to live in their hearts, they began to tell everyone the good news of Jesus. First, to the people living in Jerusalem, then out to their nearby neighbors, they went with the gospel.

The Holy Spirit worked in the hearts of many, and they turned from their sins and trusted in Jesus as their Savior. These new believers joined the disciples as they gathered together. Sundays had become their celebration day, too. God's people were growing in number. Their praises were getting louder!



18. And that's just what Jesus' disciples did. After the Holy Spirit came to live in their hearts, they began to tell everyone the good news of Jesus. First, to the people living in Jerusalem, then out to their nearby neighbors, they went with the gospel. The Holy Spirit worked in the hearts of many, and they turned from their sins and trusted in Jesus as their Savior. These new believers joined the disciples as they gathered together. Sundays had become their celebration day, too. God's people were growing in number. Their praises were getting louder!

19. Then, further and further away they went to tell the good news of Jesus to others in faraway places.

The Holy Spirit worked in the hearts of many of these people, too. They turned from their sins and trusted in Jesus as their Savior. Little churches of believers sprung up everywhere. Sundays had become their celebration day, too.



19. Then, further and further away they went to tell the good news of Jesus to others in faraway places. The Holy Spirit worked in the hearts of many of these people, too. They turned from their sins and trusted in Jesus as their Savior. Little churches of believers sprung up everywhere. Sundays had become their celebration day, too.

20. Since then, God's people keep on spreading the good news of Jesus, and the Holy Spirit keeps on working in hearts.

And what do God's people keep doing on Sundays?

They keep on gathering together to celebrate that most wonderful Sunday when Jesus rose from the dead. Their numbers keep growing and their praises get louder, as more people put their faith in Jesus. And this is why we gather together today: to celebrate how Jesus proved He beat sin and death for God's people on that wonderful Sunday, long ago!



20. Since then, God's people keep on spreading the good news of Jesus, and the Holy Spirit keeps on working in hearts. And what do God's people keep doing on Sundays? They keep on gathering together to celebrate that most wonderful Sunday when Jesus rose from the dead. Their numbers keep growing and their praises get louder, as more people put their faith in Jesus. And this his is why we gather together today: to celebrate how Jesus proved He beat sin and death for God's people on that wonderful Sunday, long ago!

15.1 Simple Story Scenes

SOLVED

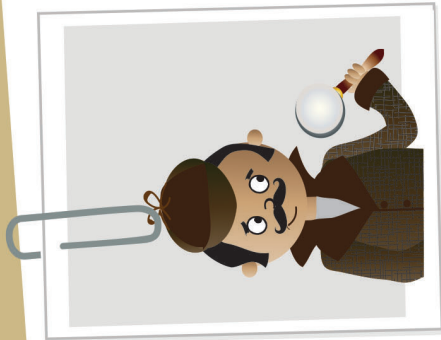

Detective Dan's Listening Assignment #1

1. What happened on the third day after Jesus died that made the disciples so happy? Jesus rose from the dead. He proved that He had really beaten sin and death for God's people.

2. What day of the week was that third day? What did Jesus' followers keep doing each week to remember that first, wonderful day? A Sunday. They started gathering together every Sunday to celebrate what Jesus had done for them.

For You and Me:
God's people around the world still celebrate with a "third day people" around the world still celebrate with a "third day God's people around the world still celebrate with a "third day yay"! They still gather together on Sundays to celebrate Jesus rising from the dead in victory over sin and death for God's people. We can join in that celebration, too, when we turn away from our sins and trust in Jesus as our Savior. Ask God to help you do this. He loves to answer this prayer.



Detective Dan's Listening Assignment #2

1 Peter 1:3, HCSB

"He has given us a new birth into a living hope through the resurrection of Jesus Christ from the dead."

1. Who celebrated Jesus' resurrection from the dead on that first, wonderful Sunday? Jesus' disciples.

2. How did they receive a new birth into a living hope? What did that mean?

They had turned away from their sins and trusted in Jesus as their Savior. God forgave their sins and made their hearts new. He sent His Holy Spirit to live inside of them, so they could know Him, and to help them love Him and live for Him. He filled their hearts with hope in Jesus now, and hope in one day going to live with Him forever in heaven. That would be best of all.

For You and Me:

Like those first followers of Jesus, we, too, can receive a new birth into a living hope. We, too, can have our sins forgiven and begin life as one of God's people. We can know God in our hearts now and one day, go to live with Him forever in heaven. How? When we turn away from our sins and trust in Jesus as our Savior.

15.1 Simple Story Scenes

Why Do God's People Go to Church?
To Worship God and Love One Another...
By Praising God for Jesus' Win over Death!

The Gospel



What a wonderful day it was when Jesus rose from the dead! He had beaten sin and death for God's people! Oh, how we needed Him to do that! You see, all people have chosen to disobey God. We all deserve His punishment.

God would have been perfectly fair to punish us all for our sins; but, He is so full of mercy that He sent His Son, Jesus, to be our Savior. Jesus lived a perfect life, then offered it as the full payment for the sins of God's people when He died on the cross. On Day Three, He rose from the dead, showing He had beaten sin and death for them.

Now, all who turn from their sins and trust in Jesus as their Savior are forgiven their sins, and become God's people. Ask God to help you do this. Then, Sunday will be your special celebration day, too!



15.1 Simple Story Scenes

A Prayer

A We praise You, God, for saving Your people, the Church. We praise You for being so powerful that You beat sin and death for them.

C God, we know that Sunday should be a special celebration day. It's the day Jesus rose from the dead. But sometimes, we would rather not go to church and celebrate. We would rather do something else that seems more fun. We don't treasure what Jesus did on the cross. We need a Savior!

T God, thank You for beating sin and death for God's people through Jesus. Thank You that they don't have to face Your punishment for sin. They get to know You in their hearts now, and get to live with You in heaven when they die. Thank You that we can be Your people, too, when we turn away from our sins and trust in Jesus as our Savior.

S God, work in our hearts. Help us to turn away from our sins and trust in Jesus as our Savior. Help us to celebrate Jesus' win over sin and death as we gather together with God's people at church.

In Jesus' name we pray. Amen.



15.1 Simple Story Scenes

DEEP DOWN DETECTIVES



Simple Story Scenes

Unit 15,

Bible Truth 2

Using Simple Story Scenes as a Curriculum

Introduce the Key Concept and Bible Verse

Simple Story Scenes give you the basics for the core of your lesson. You can use the overview sheet to introduce and explain the key concept and Bible verse.

Give the Case Assignment

Give the children a Detective Dan listening assignment. Two are provided. You can add a third using the ideas on the bonus, third take-home sheet, if desired. Each listening assignment, let's you teach the story with a different learning emphasis.

Show & Tell the Story

Hold up the pictures and tell the story from the story scenes. Alternatively, you can find in the and Pieces section for this unit at praisefactory.org, these same listening assignments and story scenes, gospel and ACTS prayer modified for view on a screen. Simply download them or open them online and show through your own monitor (tablet, big screen, whatever).

Solve the Case

Repeat Detective Dan's listening assignment question and discuss the answer.

Share the Gospel

Share the gospel tie-in with the kids.

Close in ACTS Prayer

Pray the ACTS prayer with the kids. If using the curriculum with older children, give them a chance to think up their own ACTS tie-ins to the story, using the one provided as cues/ideas for you.

Review Time

Give out the take-home sheet (there are three: two that correlates to the two Detective Dan assignments in the Story Scenes, and a bonus third one.) As the children are coloring, use the take-home sheet discussion questions or your own questions to further review and apply the key concepts, Bible verse, and story truths to the children.

Looking for more?

Online, in the Bits and Pieces section for this unit, you will find review games, crafts, storyboard flannelgraph figures, and audio and sheet music for all of the songs. There are also full lesson plans that offer more of a script and take this curriculum's possibilities to much more depth. Don't forget to tell the parents about the Parents Resources section where they can read through the Story scenes and download take homes with their kids.

Unit 15: God's People Gather Together

Unit Big Question (and Answer): Why Do God's People Go to Church?

To Worship God and Love One Another!

Unit Bible Verse: "And let us consider how to stir up one another to love and good works, not neglecting to meet together." Hebrews 10:24-25, ESV

Bible Truth 2 Concept: To Worship God and Love One Another... By Learning from God's Word, the Bible

God's people gather together to learn from the Bible. There is no other book like it. It alone is God's Word. It is the best place to find out about God and how to obey Him. But that's not all! The Bible is not just words that God's people listen to and learn from. God's Word is powerful! The Holy Spirit works inside of people as they hear God's Word. He uses it to help them turn away from their sins and trust in Jesus as their Savior. This is how we become God's people. (The big, Bible word for this is "conversion.") And, He uses it to help us to know God better, to give us hope, and to obey Him. This is how we live as God's people. (The big, Bible word for this is "discipleship.")

Sometimes God's people learn from the Bible in little groups. (You are probably learning about the Bible in one of these right now!) But the most important way God's people learn from God's Word is when they all gather together as a congregation and listen to a godly man preach from the Bible. The Bible calls these men, pastors (or elders). God has called them to preach God's Word and to lead God's people in living for Him. What a great gift they are to God's people!

The pastor stands in front of the congregation (God's people gathered together). He reads to them from the Bible and explains what it means. He helps them understand how to live it out. (The big, Bible word for this is "expositional preaching.") The Holy Spirit helps the pastor and the congregation as they study God's Word together.

It is very important for God's people to hear the Bible when they gather together. God uses it to work powerfully in their lives. We can be God's people, too, when we turn away from our sins and trust in Jesus as our Savior. God can use His Word to work powerfully in our lives, too.

Bible Truth 2 Bible Verse: 1 Timothy 4:13, ESV

"Devote yourself to the public reading of Scripture, to exhortation, to teaching."

Learn a Little: "Devote yourself to the reading of Scripture."

Meaning

God's people gather together to worship God and love one another. And what book tells them how to do this best of all? God's Word, the Bible! The Bible helps God's people know how God wants them to live; and, it is powerful to help them live that way. No wonder God's people devote themselves to the Bible. They want their leaders to read it to them and to teach them what it means when they gather together. It alone is God's Word! We can become God's people when we turn away from our sins and trust in Jesus as our Savior. God can use His Word to work powerfully in our lives, too.

Bible Truth 2 ACTS Prayer

- A** We praise You, God, for saving Your people, the Church. We praise You for giving us the Bible and godly leaders to teach it to us.
- C** God, sometimes we don't want to learn from the Bible. Sometimes, we don't want to listen to the pastors preach from Your Word. There are other things we would rather do. We need a Savior!
- T** God, thank You for not leaving us on our own, but giving us Your Word, the Bible, to learn from and to live by. Thank You for all the people in church who help us understand Your Word and live it out. Thank You for our pastors and teachers.
- S** God, work in our hearts. Help us to turn away from our sins and trust in Jesus as our Savior. Help us to love Your Word and learn it. Help us live it out. Help our pastors and teachers to teach us well about You. In Jesus' name we pray, Amen.

Bible Truth 2 Story**The Case of the Faithful Leader**

Acts 16:1; 1 & 2 Timothy

Songs Used in Bible Truth 2

Big Q & A 15 Song

Big Question 15 Song: Why Do God's People Go to Church?

Big Question 15 Bible Verse Song: Stir Up Hebrews 10:24-25, ESV

Big Question 15 Hymn: Brethren, We Have Met to Worship, v.1

Big Question 15 Praise Song: Praise the Lord Together

Bible Truth 2 Bible Verse: Devote Yourself 1 Timothy 4:13, ESV

Bible Truth 2 Extra Bible Verse: An Overseer Must Be Titus 1:6-9, ESV

Bible Truth 2 Extra Bible Verse: Open My Eyes Psalm 119:18,72-73, ESV

Bible Truth 2 Extra Bible Verse: I Have Stored Up Your Word Psalm 119:11,15-16, ESV

Bible Truth 2 Extra Bible Verse: If Anyone Loves Me John 14:23, ESV

listen to or download songs for free at <https://praisefactory.org>: Deep Down Detectives Music page

“The Case of the Faithful Leader” Acts 16:1, 1 & 2 Timothy

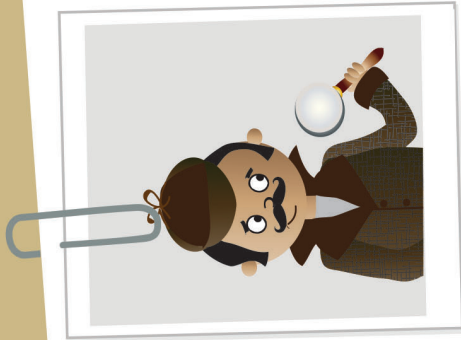

Detective Dan's Listening Assignment #1

1. Who was the pastor chosen to care for the believers in Ephesus?
2. What did Paul tell him to be faithful to do for those believers?



Detective Dan's Listening Assignment #2

1 Timothy 4:13, ESV

“Devote yourself to the public reading of Scripture, to exhortation, to teaching.”

1. Whom did Paul write to when he was in prison and about to die?
2. What did Paul tell this person to be faithful to do for the believers in Ephesus?

(more listening and discussion questions are included in the curriculum at praisefactory.org)

I. Paul was an old man who was about to die. His enemies had put him in jail for telling people about Jesus, and now they planned to kill him. Paul sat in his cold cell making the best of the little time he had left.

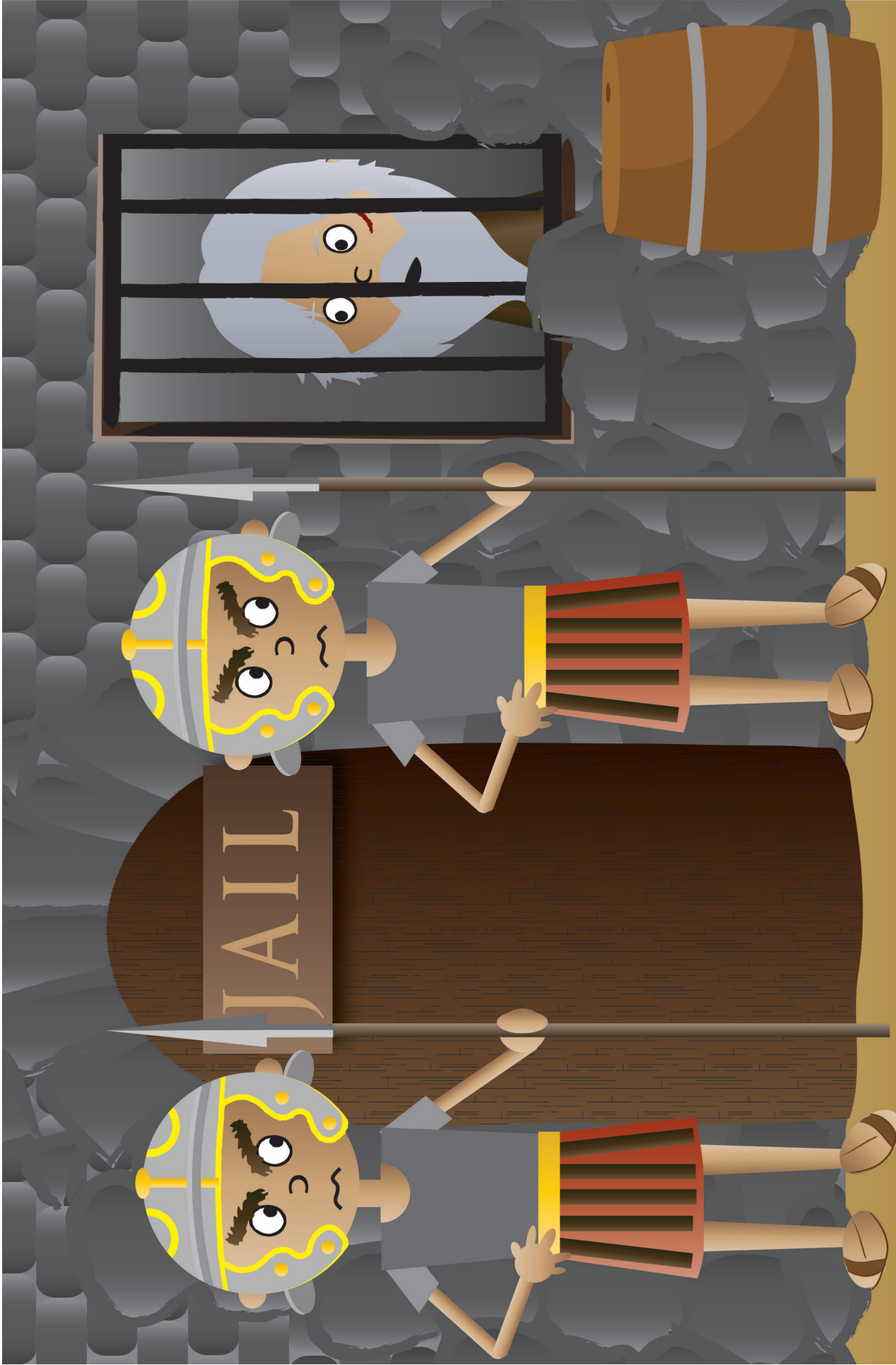

I. Paul was an old man who was about to die. His enemies had put him in jail for telling people about Jesus, and now they planned to kill him. Paul sat in his cold cell making the best of the little time he had left.

2. Even in jail, Paul found ways to love God and His people. Paul prayed. He shared the good news of Jesus with the soldiers who guarded him and with many others. And, he wrote letters to the little churches of believers in many places.

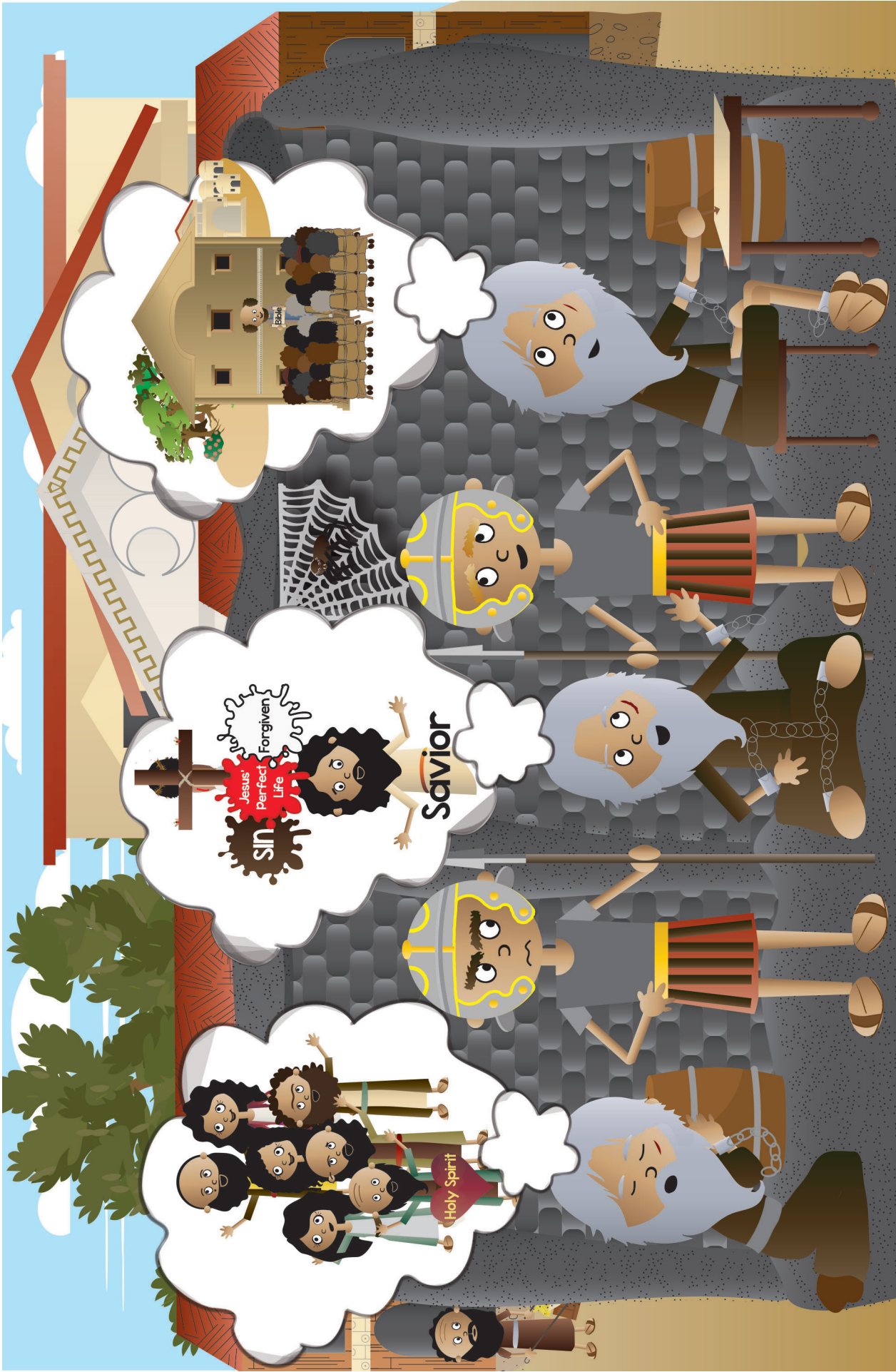

2. Even in jail, Paul found ways to love God and His people. Paul prayed. He shared the good news of Jesus with the soldiers who guarded him and with many others. And, he wrote letters to the little churches of believers in many places.

3. Paul's life in jail was very different from what it used to be.

Paul had been a missionary. He travelled to many faraway places, preaching the good news of Jesus to all who would listen.

Many people turned away from disobeying God and trusted in Jesus as their Savior when they heard Paul preach. Soon, there were little churches of these new Christians all over. They gathered together each week to worship God and love one another.



3. Paul's life in jail was very different from what it used to be. Paul had been a missionary. He travelled to many faraway places, preaching the good news of Jesus to all who would listen. Many people turned away from disobeying God and trusted in Jesus as their Savior when they heard Paul preach. Soon, there were little churches of these new Christians all over. They gathered together each week to worship God and love one another.

4. Godly leaders were chosen to take care of the members of each little church gathering.

Some of these leaders were called “deacons.”

They were used by God to serve their little church in a special way. They spent their time caring for the needs of others in the church. Men like Stephen made sure everyone had enough to eat. Women like Phoebe spent their days serving the needs of others in so many ways, too.



4. Godly leaders were chosen to take care of the members of each little church gathering. Some of these leaders were called “deacons.” They were used by God to serve their little church in a special way. They spent their time caring for the needs of others in the church. Men like Stephen made sure everyone had enough to eat. Women like Phoebe spent their days serving the needs of others in so many ways, too.

5. Other godly leaders were men called “pastors” or “elders. These men were used by God to serve their little church by teaching God’s Word and leading everyone in loving God and living for Him.

Sometimes, these pastors brought words of comfort to those who were discouraged. Sometimes, they warned those forgetting to live for God and urged them to turn away from their sins. They prayed for God to help them all. And, they preached God’s Word when the Christians in each little church gathered together.



5. Other godly leaders were men called “pastors” or “elders.” These men were used by God to serve their little church by teaching God’s Word and leading everyone in loving God and living for Him. Sometimes, these pastors brought words of comfort to those who were discouraged. Sometimes, they warned those forgetting to live for God and urged them to turn away from their sins. They prayed for God to help them all. And, they preached God’s Word when the Christians in each little church gathered together.

6. A young man named Timothy would become one of these godly pastors.



6. A young man named Timothy would become one of these godly pastors.

7. Paul met Timothy on one of his traveling trips and asked him to be his helper. Mile after mile, Timothy walked with Paul. Up mountains and down valleys. Over land and over sea. Through every kind of weather. To every kind of people.



7. Paul met Timothy on one of his traveling trips and asked him to be his helper. Mile after mile, Timothy walked with Paul. Up mountains and down valleys. Over land and over sea. Through every kind of weather. To every kind of people.

8. There were happy, friendly people who wanted to hear about Jesus, and welcomed them. And, there were angry, fierce people who hated Paul, and wanted to make him stop telling about Jesus. They hurt Paul, and sent him to live in cold, prison cells. Timothy stayed by Paul through it all.



8. There were happy, friendly people who wanted to hear about Jesus, and welcomed them. And, there were angry, fierce people who hated Paul, and wanted to make him stop telling about Jesus. They hurt Paul, and sent him to live in cold, prison cells. Timothy stayed by Paul through it all.

9. But most of all, it was the love in Timothy's heart that made him such a good helper for Paul.

Timothy had a heart devoted to God and His good plans. Timothy loved God's Word and knew it well. He loved God, and Paul, and God's people so much, that he put them first, instead of himself!



9. But most of all, it was the love in Timothy's heart that made him such a good helper for Paul. Timothy had a heart devoted to God and His good plans. Timothy loved God's Word and knew it well. He loved God, and Paul, and God's people so much, that he put them first, instead of himself!

10. So, you can see why Paul loved Timothy so much, and why Timothy was such a good helper for Paul. After a while, Paul treated Timothy not just as a helper, or even a very good friend, but like Timothy was his very own son.



10. So, you can see why Paul loved Timothy so much, and why Timothy was such a good helper for Paul. After a while, Paul treated Timothy not just as a helper, or even a very good friend, but like Timothy was his very own son.

II. Yes, Timothy was a big help to Paul, but did you know that Paul was a big help to Timothy, too?

As Timothy travelled with Paul, he was listening and learning. He listened to Paul preach from God's Word and share the good news of Jesus. He saw many people turn away from their sins and trust in Jesus as their Savior.

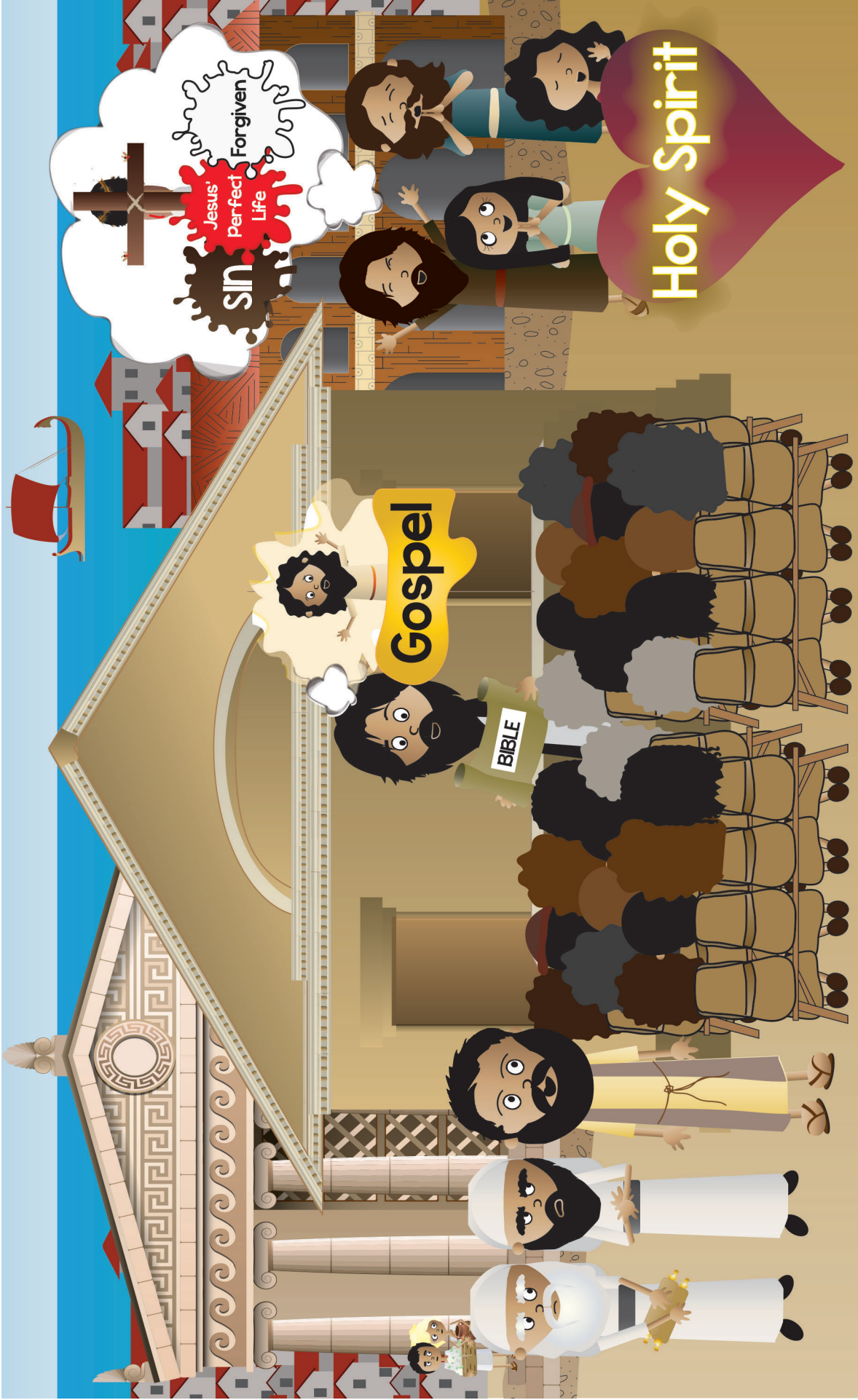

II. Yes, Timothy was a big help to Paul, but did you know that Paul was a big help to Timothy, too? As Timothy travelled with Paul, he was listening and learning. He listened to Paul preach from God's Word and share the good news of Jesus. He saw many people turn away from their sins and trust in Jesus as their Savior.

12. Timothy listened to Paul teach these new believers how to live as Jesus' disciples. Paul taught them how to love God and live for Him their whole lives.

Timothy listened to Paul use God's Word to comfort sad people and to warn others who had stopped living for God. Timothy watched Paul pray for the little churches to stay faithful and grow. And as Timothy listened and watched, God was preparing him for His plans for him. Can you guess what God planned for Timothy to be? A pastor, himself!



12. Timothy listened to Paul teach these new believers how to live as Jesus' disciples, who would love God and live for Him their whole lives. Timothy listened to Paul use God's Word to comfort sad people and to warn others who had stopped living for God. Timothy watched Paul pray for the little churches to stay faithful and grow. And as Timothy listened and watched, God was preparing him for His plans for him. Can you guess what God planned for Timothy to be? A pastor, himself!

13. One day, Paul and Timothy came to city of Ephesus. They had come to check up on the little church of believers there.

Uh oh, Paul could see there was a problem! This little church of believers needed a good pastor. Who could help them? Who knew God's Word well enough to help them grow to worship God and love one another the way God wanted them to? None of the new believers in the little Ephesus church could do this yet.



13. One day, Paul and Timothy came to city of Ephesus. They had come to check up on the little church of believers there. Uh oh, Paul could see there was a problem! This little church of believers needed a good pastor. Who could help them? Who knew God's Word well enough to help them grow to worship God and love one another the way God wanted them to? None of the new believers in the little Ephesus church could do this yet.

14. Perhaps there was no one in the little church who could be their pastor, but there WAS someone with Paul who could stay and lead them. Can you guess who?

It was Timothy! “Would you stay and care for this little church of believers?” Paul asked Timothy. “You are young, but I know that God will help you do a good job preaching the Bible and leading them,” he said.



14. Perhaps there was no one in the little church who could be their pastor, but there WAS someone with Paul who could stay and lead them. Can you guess who? It was Timothy! “Would you stay and care for this little church of believers?” Paul asked Timothy. “You are young, but I know that God will help you do a good job preaching the Bible and leading them,” he said.

15. Timothy agreed to stay. He would miss Paul, but he was happy to help.

The little church in Ephesus was happy, too. Now, they had a godly pastor who could help them love God and live for Him. Paul was so glad that he could leave the little church in Ephesus under Timothy's care.



15. Timothy agreed to stay. He would miss Paul, but he was happy to help. The little church in Ephesus was happy, too. Now, they had a godly pastor who could help them love God and live for Him. Paul was so glad that he could leave the little church in Ephesus under Timothy's care.

16. But now, so many years had passed since Paul left Timothy in Ephesus.

What a lot of journeys Paul had taken since then. What a lot of people got to hear the good news of Jesus and trusted in Him as their Savior! Little churches of new believers gathered every Sunday, where there used to be none. God had filled Paul's years with good things.



16. But now, so many years had passed since Paul left Timothy in Ephesus. What a lot of journeys Paul had taken since then. What a lot of people got to hear the good news of Jesus and trusted in Him as their Savior! Little churches of new believers gathered every Sunday, where there used to be none. God had filled Paul's years with good things.

17. But, oh, what troubles had come to Paul along with those blessings! Preaching the good news of Jesus was no easy thing. It was why Paul was in jail in Rome, alone, shivering in the cold, and soon to die.

Paul longed to see that closest friend of his: Timothy! Paul missed his dear Timothy so very much! Paul wanted him to come and care for him. Paul wanted him to bring him his heavy cloak to keep him warm, and his books and papers, so he could study.



17. But, oh, what troubles had come to Paul along with those blessings! Preaching the good news of Jesus was no easy thing. It was why Paul was in jail in Rome, alone, shivering in the cold, and soon to die. Paul longed to see that closest friend of his: Timothy! Paul missed his dear Timothy so very much! Paul wanted him to come and care for him. Paul wanted him to bring him his heavy cloak to keep him warm, and his books and papers, so he could study.

18. Paul wondered if he would get to see Timothy again before he died. He hoped he would. But Ephesus was so far away from Rome! And there were no telephones or even postmen back then. How could Paul tell Timothy he needed him?

What could Paul do? Paul could write to Timothy and find someone to take it to him. And even if Timothy could not get to Rome before he died, at least Paul could give him one last message. And so, that's what he did.



18. Paul wondered if he would get to see Timothy again before he died. He hoped he would. But Ephesus was so far away from Rome! And there were no telephones or even postmen back then. How could Paul tell Timothy he needed him? What could Paul do? Paul could write to Timothy and find someone to take it to him. And even if Timothy could not get to Rome before he died, at least Paul could give him one last message. And so, that's what he did.

19. Before long, a messenger was on his way to Ephesus with Paul's letter. Walk, walk, walk, he went. At last, after many days, he handed the letter to Timothy to read.

Timothy was so happy to hear from Paul. How he missed Paul and loved him! Here was news, at last! Timothy eagerly opened the letter and read. "Timothy, my dear son," Paul started. "I thank God every time I think of you. I long with tears to see you. Do your best to come to me soon."

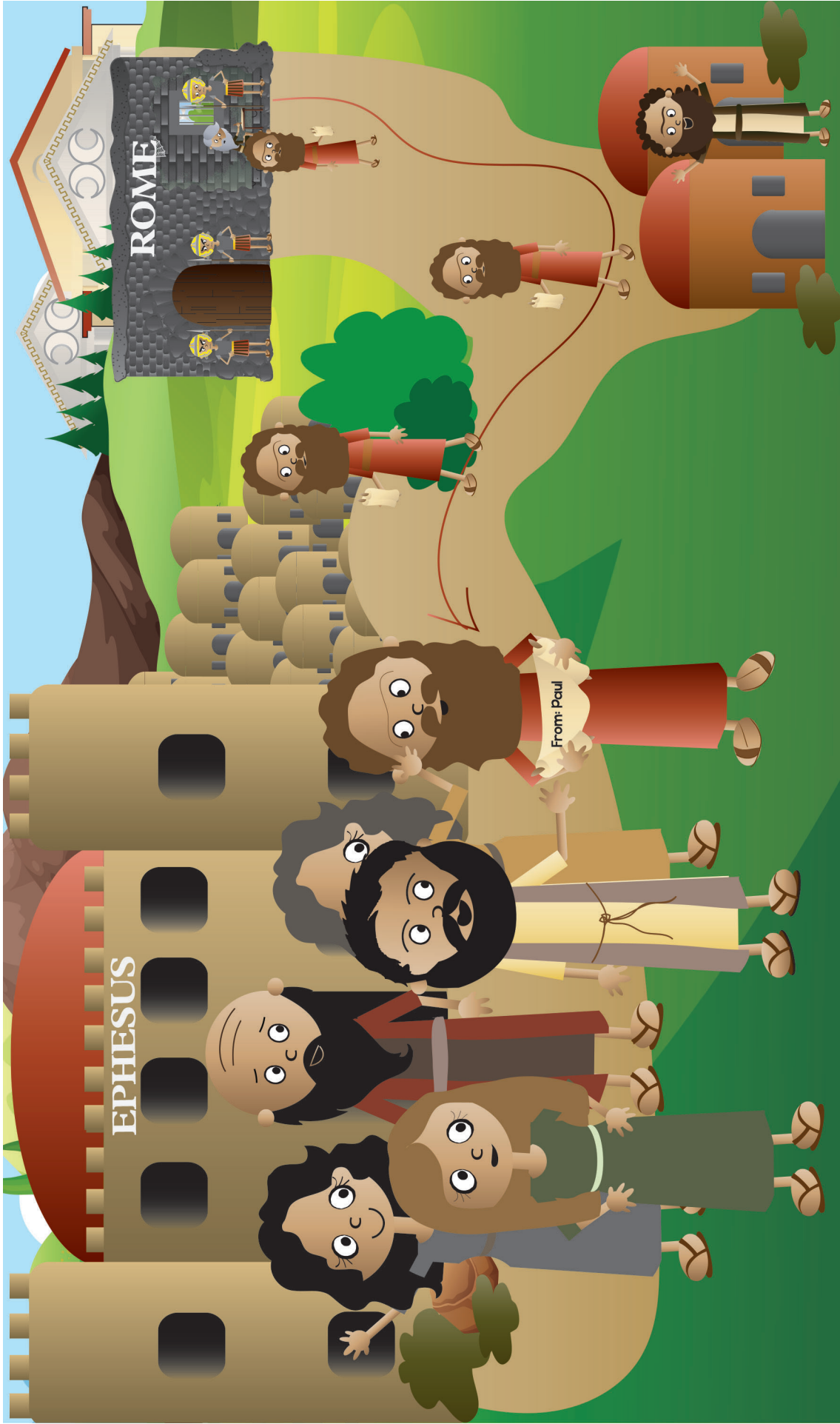

19. Before long, a messenger was on his way to Ephesus with Paul's letter. Walk, walk, walk, he went. At last, after many days, he handed the letter to Timothy to read.

Timothy was so happy to hear from Paul. How he missed Paul and loved him! Here was news, at last! Timothy eagerly opened the letter and read. "Timothy, my dear son," Paul started. "I thank God every time I think of you. I long with tears to see you. Do your best to come to me soon."

20. “Here are some important things I want you to remember that will help you lead the little church in Ephesus,” Paul wrote.

“You were my helper for many years. You watched me preach about Jesus from the Bible. You watched people try to get me to stop talking about Jesus by hurting me,” Paul wrote.

“You saw how God gave me strength to keep on preaching, and loving, and caring for all the Christians in the little churches we went to. Don’t forget what you saw me do! Do these same things for the people in your little church.”



20. "Here are some important things I want you to remember that will help you lead the little church in Ephesus," Paul wrote. "You were my helper for many years. You watched me preach about Jesus from the Bible. You watched people try to get me to stop talking about Jesus by hurting me," Paul wrote. "You saw how God gave me strength to keep on preaching, and loving, and caring for all the Christians in the little churches we went to. Don't forget what you saw me do! Do these same things for the people in your little church."

21. “Keep on learning God’s Word! Keep on preaching God’s Word!” Paul told Timothy.

“Sometimes this will be really hard. Sometimes people won’t want to hear what the Bible says. But keep on teaching it to them, no matter what!” Paul urged Timothy.

“Only the Bible is God’s Word. It makes God’s people ready for everything God wants them to do. Don’t forget these things and please, come see me soon --before winter comes. Paul.”



21. "Keep on learning God's Word! Keep on preaching God's Word!" Paul told Timothy. "Sometimes this will be really hard. Sometimes people won't want to hear what the Bible says. But keep on teaching it to them, no matter what!" Paul urged Timothy. "Only the Bible is God's Word. It makes God's people ready for everything God wants them to do. Don't forget these things and please, come see me soon --before winter comes. Paul."

22. Did Timothy ever make it to see Paul before he died? We don't know.

But we DO know that Timothy did what Paul wanted him to do most of all: be a good pastor for the little church in Ephesus and teach them God's Word.



22. Did Timothy ever make it to see Paul before he died? We don't know. But we DO know that Timothy did what Paul wanted him to do most of all: be a good pastor for the little church in Ephesus and teach them God's Word.

DDD 15.2 Simple Story Scenes

“The Case of the Faithful Leader” Acts 16:1, 1 & 2 Timothy

SOLVED



Detective Dan's Listening Assignment #1

1. Who was the pastor chosen to care for the believers in Ephesus?
Timothy.

2. What did Paul tell him to be faithful to do for those believers? Paul told Timothy to be faithful to preach God's Word to them and help them keep on loving God and living for Him.

For You and Me:
Paul encouraged Timothy to be faithful to teach God's Word to the believers who gathered together as a little church in Ephesus. By being faithful like this, God could use Timothy powerfully. Timothy could help the believers know how to keep on loving God and living for Him. When we go to church and listen to faithful teachers tell us about God's Word, God can use it to help us to love Him and live for Him, too. And the very first thing that every faithful teacher hopes and prays that you will do when you hear God's Word is to turn away from your sins and trust in Jesus as your Savior. This is how we become God's people. It is the best, first step in loving God and living for Him.



Detective Dan's Listening Assignment #2

1 Timothy 4:13, ESV

“Devote yourself to the public reading of Scripture, to exhortation, to teaching.”

1. Whom did Paul write to when he was in prison and about to die? Timothy.

2. What did Paul tell this person to be faithful to do for the believers in Ephesus? Paul told Timothy to be faithful to preach God's Word to them and help them keep on loving God and living for Him.

For You and Me:

Paul encouraged Timothy to be faithful to teach God's Word to the believers who gathered together as a little church in Ephesus. By being faithful like this, God could use Timothy powerfully. Timothy could help the believers know how to keep on loving God and living for Him. When we go to church and listen to faithful teachers tell us about God's Word, God can use it to help us to love Him and live for Him, too. And the very first thing that every faithful teacher hopes and prays that you will do when you hear God's Word is to turn away from your sins and trust in Jesus as your Savior. This is how we become God's people. It is the best, first step in loving God and living for Him.

DDD 15.2 Simple Story Scenes

Why Do God's People Go to Church?
To Worship God and Love One Another...
By Learning from God's Word, the Bible!

The Gospel

God's people love the Bible. Each time they gather together, they want to learn more from it. The Bible is how they learned they were sinners who deserved God's punishment for disobeying Him, and of God's rich mercy in sending Jesus to be our Savior. It tells how Jesus lived a perfect life and offered it on the cross as the full payment for the sins of God's people. And, how He rose from the dead on the third day, beating sin and death for them.

The Bible tells us how we can become God's people by turning away from our sins and trusting in Jesus as our Savior. And, how we can know and love God better, and live for Him. Ask God to use the Bible to teach you and help you do these things, too. He loves to answer this prayer!



DDD 15.2 Simple Story Scenes

A Prayer

A We praise You, God, for saving Your people, the Church. We praise You for giving us the Bible and godly leaders to teach it to us.

C God, sometimes we don't want to learn from the Bible. Sometimes, we don't want to listen to the pastors preach from Your Word. There are other things we would rather do. We need a Savior!

T God, thank You for not leaving us on our own, but giving us Your Word, the Bible, to learn from and live by. Thank You for all the people in church who help us understand Your Word and live it out. Thank You for our pastors and teachers.

S God, work in our hearts. Help us to turn away from our sins and trust in Jesus as our Savior. Help us to love Your Word and learn it. Help us live it out. Help our pastors and teachers to teach us well about You.

In Jesus' name we pray, Amen.



DDD 15.2 Simple Story Scenes

DEEP DOWN DETECTIVES



Simple Story Scenes

Unit 15,

Bible Truth 3

Using Simple Story Scenes as a Curriculum

Introduce the Key Concept and Bible Verse

Simple Story Scenes give you the basics for the core of your lesson. You can use the overview sheet to introduce and explain the key concept and Bible verse.

Give the Case Assignment

Give the children a Detective Dan listening assignment. Two are provided. You can add a third using the ideas on the bonus, third take-home sheet, if desired. Each listening assignment, let's you teach the story with a different learning emphasis.

Show & Tell the Story

Hold up the pictures and tell the story from the story scenes. Alternatively, you can find in the and Pieces section for this unit at praisefactory.org, these same listening assignments and story scenes, gospel and ACTS prayer modified for view on a screen. Simply download them or open them online and show through your own monitor (tablet, big screen, whatever).

Solve the Case

Repeat Detective Dan's listening assignment question and discuss the answer.

Share the Gospel

Share the gospel tie-in with the kids.

Close in ACTS Prayer

Pray the ACTS prayer with the kids. If using the curriculum with older children, give them a chance to think up their own ACTS tie-ins to the story, using the one provided as cues/ideas for you.

Review Time

Give out the take-home sheet (there are three: two that correlates to the two Detective Dan assignments in the Story Scenes, and a bonus third one.) As the children are coloring, use the take-home sheet discussion questions or your own questions to further review and apply the key concepts, Bible verse, and story truths to the children.

Looking for more?

Online, in the Bits and Pieces section for this unit, you will find review games, crafts, storyboard flannelgraph figures, and audio and sheet music for all of the songs. There are also full lesson plans that offer more of a script and take this curriculum's possibilities to much more depth. Don't forget to tell the parents about the Parents Resources section where they can read through the Story scenes and download take homes with their kids.

Unit 15: God's People Gather Together

Unit Big Question (and Answer): Why Do God's People Go to Church?

To Worship God and Love One Another!

Unit Bible Verse: "And let us consider how to stir up one another to love and good works, not neglecting to meet together." Hebrews 10:24-25, ESV

Bible Truth 3 Concept: To Worship God and Love One Another... By Caring for Each Other's Needs!

When God's people gather together, they make special promises to believe God's Word and to care for each other. They promise to help each other keep on loving God and living for Him.

How do God's people help each other keep these promises? They help each other love God and live for Him. They tell each other about their lives—the many happy things, the sad things, even their sins and their struggles. They pray for each other and remind each other of the truths in God's Word. They want to help everyone to keep growing in their life with God.

But they also care for each other's needs. They share their money and their things when someone is hungry or has lost their job. They visit each other when they are sick. They cheer each other up when they are sad or lonely. They want to help everyone to be well-cared for.

God gives each little church special leaders that help them care for each other, too. He gives them pastors/elders to teach them God's Word and help them live it out. They comfort those who are scared and weak. They strengthen those who are struggling with sin. They pray for all.

God gives each little church special leaders called deacons, too. Deacons help everyone to better care for each other's needs. They spend extra time finding out what people need and helping them get it.

Jesus told God's people to love each other and take care of each other just as He has loved and taken care of them. If they do this, Jesus promised that others will see their love and know that they are God's people. They will praise God for how wonderful He is and want to become His people, too. We can become God's people when we turn away from our sins and trust in Jesus as our Savior.

Bible Truth 3 Bible Verse: John 13:34-35, ESV

"A new commandment I give to you, that you love one another: just as I have loved you, you also are to love one another. By this all people will know that you are my disciples, if you have love for one another."

Learn a Little: "Love one another: just as I have loved you."

Meaning

A commandment is a big rule God tells us to obey! What does Jesus command His people to do? To love one another like He has loved them! Wow! That's a lot of love! Only with God's help can God's people do that! But when they do, others will know that they really are God's people! We can become God's people when we turn away from our sins and trust in Jesus as our Savior.

Bible Truth 3 ACTS Prayer

- A** We praise You, God, for being the Savior of Your people, the Church. We praise You for Your kindness and love shown through Your people caring for each other.
- C** God, sometimes we don't want to go to church and care for the needs of others. Sometimes we just want to take care of our own needs. We need a Savior!
- T** Thank You, God, for giving Your people to each other to care for their needs. Thank You for all the people in church who care for our needs.
- S** God, work in our hearts. Help us to turn away from our sins and trust in Jesus as our Savior. Make us Your people! Help us to care for others when we gather at church. In Jesus' name we pray, Amen.

Bible Truth 3 Story**The Case of the Copycats**

John 13-15, 18-20; Acts

Songs Used in Bible Truth 3

Big Q & A 15 Song

Big Question 15 Song: Why Do God's People Go to Church?

Big Question 15 Bible Verse Song: Stir Up Hebrews 10:24-25, ESV

Big Question 15 Hymn: Brethren, We Have Met to Worship, v.1

Big Question 15 Praise Song: Praise the Lord Together

Bible Truth 3 Bible Verse: A New Commandment John 13:34-35, ESV

Bible Truth 3 Extra Bible Verse: There Are Different Kinds of Gifts 1 Corinthians 12:4,12,27, NIV 1984

Bible Truth 3 Extra Bible Verse: As Each Has Received a Gift 1 Peter 4:10-11, ESV

Bible Truth 3 Extra Bible Verse: Gift, Gift, Gift 1 Peter 4:10-11, ESV (other version)

Bible Truth 3 Extra Bible Verse: Encourage One Another 1 Thessalonians 5:11,13-15, ESV

Bible Truth 3 Extra Bible Verse: Build One Another Up 1 Thessalonians 5:11,13-15, ESV

Bible Truth 3 Extra Bible Verse: Let Us Hold Fast Hebrew 10:23-25, ESV

Bible Truth 3 Extra Bible Verse: On the First Day of Every Week 1 Corinthians 16:2, HCSB

Bible Truth 3 Extra Bible Verse: An Overseer Must Be Titus 1:6-9, ESV

Bible Truth 3 Extra Bible Verse: Love 1 Corinthians 13:4-8,13, ESV

Bible Truth 3 Extra Bible Verse: Love Is Patient 1 Corinthians 13:4-8, ESV

listen to or download songs for free at <https://praisefactory.org>: Deep Down Detectives Music page

“The Case of the Copycats” John 13-15, 18-20; Acts

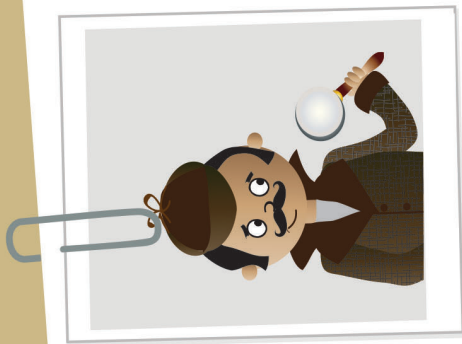

Detective Dan's Listening Assignment #1

A copycat is a nickname for someone who tries to act like someone else.

1. Who were the people who tried to act like someone else?
2. And who was the someone they try to act like? Why?



Detective Dan's Listening Assignment #2

John 13:34, ESV

“Love one another: just as I have loved you.”

1. What was Jesus' love for His people like?
2. Who wanted to obey Jesus' command to love one another as He had loved them? Who helped them do this?

(more listening and discussion questions are included in the curriculum at praisefactory.org)

1. The sun was setting as Jesus and his disciples gathered for supper. It was their last meal together, their last hours together, before “IT” happened.

What was “IT”? Enemies would come and take Jesus. He would suffer and die on the cross for the sins of God’s people.



I. The sun was setting as Jesus and his disciples gathered for supper. It was their last meal together, their last hours together, before "IT" happened. What was "IT"? Enemies would come and take Jesus. He would suffer and die on the cross for the sins of God's people.

2. Jesus knew “IT” was about to happen, but His disciples did not. With only a little time left to teach and prepare them, what did Jesus want them to remember? And how would He tell them?

Jesus would use FEET and FOOD, right there at the table, to teach them.



2. Jesus knew "IT" was about to happen, but His disciples did not. With only a little time left to teach and prepare them, what did Jesus want them to remember? And how would He tell them? Jesus would use FEET and FOOD, right there at the table, to teach them.

3. Now, feet are always dirty, but they were especially so in Jesus' world.

There were no cars back then and very few stone roads. It was walk, walk, walk on sandy, muddy, dirty ground. Camels and donkeys shared with roads, adding more stuff to step in. And, since people wore sandals or went barefoot, you can imagine just how yucky your feet could get.

Yes, feet were yucky things and washing them was an everyday, before each meal, dirty business. And so dirty, that only you or your lowest servant would ever touch your feet.



3. Now, feet are always dirty, but they were especially so in Jesus' world. There were no cars back then and very few stone roads. It was walk, walk, walk on sandy, muddy, dirty ground. Camels and donkeys shared with roads, adding more stuff to step in. And, since people wore sandals or went barefoot, you can imagine just how yucky your feet could get. Yes, feet were yucky things and washing them was an everyday, before each meal, dirty business. And so dirty, that only you or your lowest servant would ever touch your feet.

4. Imagine how horrified the disciples were when Jesus got up from the table that night and began to wash their feet!

“Teacher, never wash my feet!” Peter exclaimed. The others agreed. Jesus was God’s Son. He shouldn’t use His holy, perfect life to clean their dirty, yucky feet!



4. Imagine how horrified the disciples were when Jesus got up from the table that night and began to wash their feet! "Teacher, never wash my feet!" Peter exclaimed. The others agreed. Jesus was God's Son. He shouldn't use His holy, perfect life to clean their dirty, yucky feet!

5. But Jesus just kept washing.

“You can have no part in what I’m doing, if I don’t wash your feet,” Jesus told Peter. This was a teaching picture about the “IT” Jesus was about to do for them the next day, when He would give up His life on the cross to clean the sin from their hearts. It was something only He could do for them.



5. But Jesus just kept washing. “You can have no part in what I’m doing, if I don’t wash your feet,” Jesus told Peter. This was a teaching picture about the “IT” Jesus was about to do for them the next day, when He would give up His life on the cross to clean the sin from their hearts. It was something only He could do for them.

6. Jesus had taught them with feet, now He would teach them more about “T” with food. Jesus took the bread and wine and gave them to his disciples as two more teaching pictures.

“This is my body, broken for you,” He told them, as He held out the bread to them to eat. “This is my blood, poured out for you,” He told them, as He held out the wine for them to drink.



6. Jesus had taught them with feet, now He would teach them more about "IT" with food. Jesus took the bread and wine and gave them to his disciples as two more teaching pictures. "This is my body, broken for you," He told them, as He held out the bread to them to eat. "This is my blood, poured out for you," He told them, as He held out the wine for them to drink.

7. These were pictures of what Jesus would do that next day for them.

On the cross, Jesus' body would be broken, and His blood would be poured as the full payment for the sins of God's people. Jesus would use His holy, perfect life to clean the sin from their hearts.

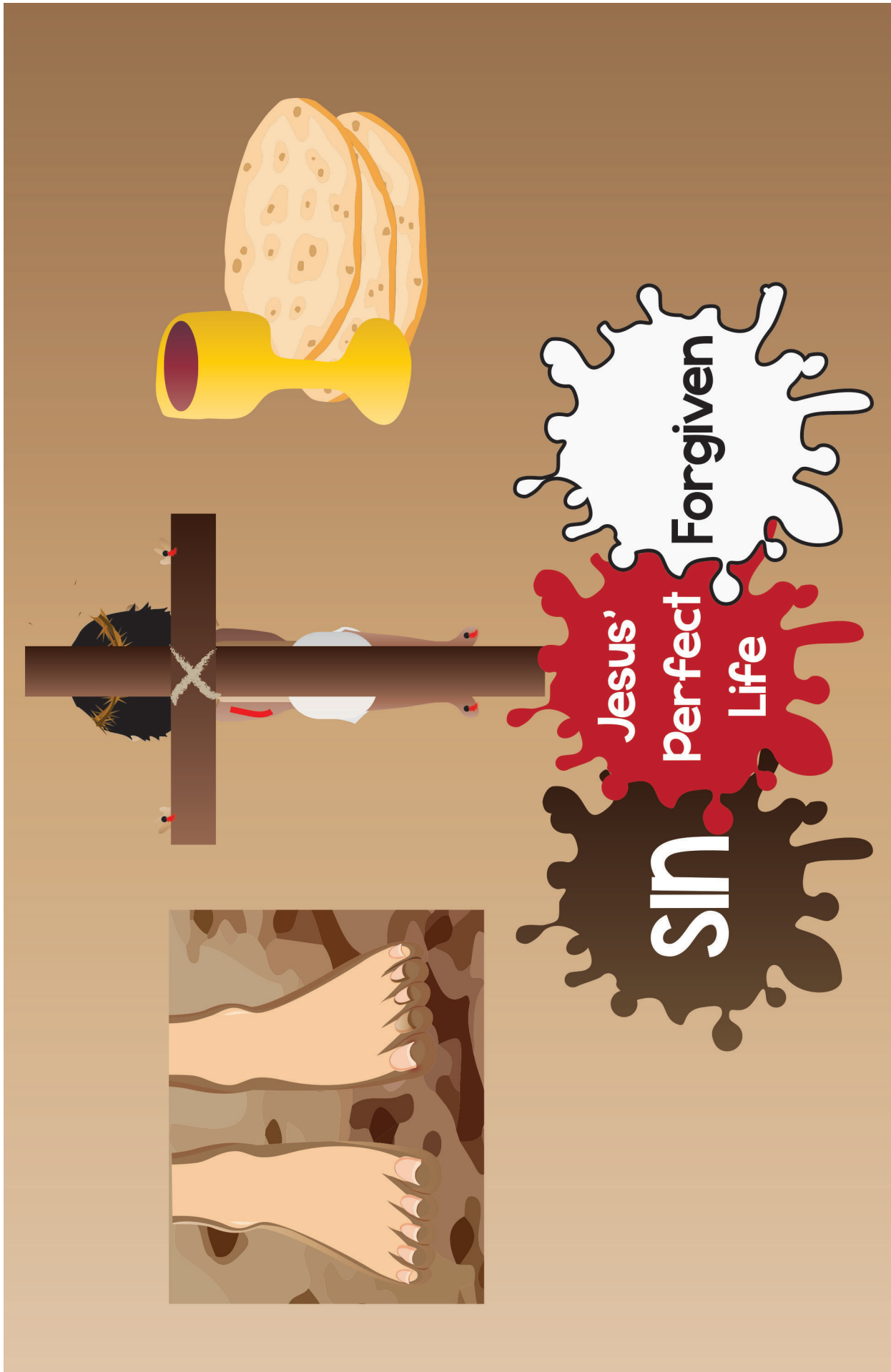

7. These were pictures of what Jesus would do that next day for them. On the cross, Jesus' body would be broken, and His blood would be poured as the full payment for the sins of God's people. Jesus would use His holy, perfect life to clean the sin from their hearts.

8. Why would Jesus do such a thing? Why would He suffer and die for God's people?

There is only one reason: love. Love for God, His Father. And love for God's people. This was God's plan to save His people. This was the only way. And, as much as Jesus did not like to hurt and suffer, He loved His Father and God's people even more.



8. Why would Jesus do such a thing? Why would He suffer and die for God's people? There is only one reason: love. Love for God, His Father. And love for God's people. This was God's plan to save His people. This was the only way. And, as much as Jesus did not like to hurt and suffer, He loved His Father and God's people even more.

9. “I am about to go away,” Jesus told His disciples. “I am making the way for you and all of God’s people to come to God. I am going to prepare a place for you to live with God forever. One happy day, I will come back for you to take you home to be with Me,” Jesus told them.

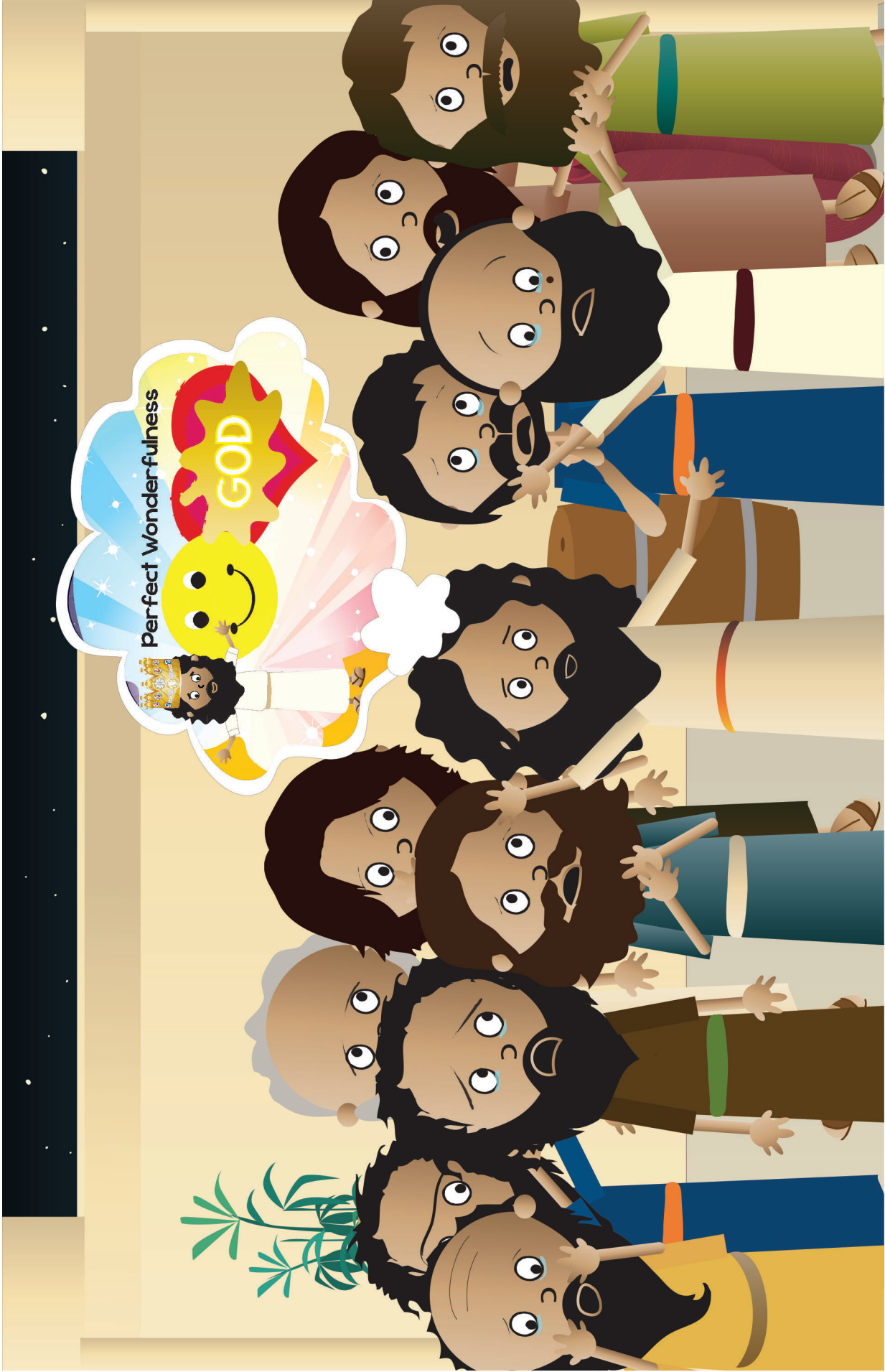

9. "I am about to go away," Jesus told His disciples. "I am making the way for you and all of God's people to come to God. I am going to prepare a place for you to live with God forever. One happy day, I will come back for you to take you home to be with Me," Jesus told them.

10. “I’m not leaving you alone. I am sending you a special Comforter, the Holy Spirit,” Jesus promised them. “He will live in your hearts. He will keep us close. He will give you power to do everything God wants you to do,” Jesus explained.

But what DID God want them to do? It went back to that one word for everything Jesus did: love.



10. "I'm not leaving you alone. I am sending you a special Comforter, the Holy Spirit," Jesus promised them. "He will live in your hearts. He will keep us close. He will give you power to do everything God wants you to do," Jesus explained. But what DID God want them to do? It went back to that one word for everything Jesus did: love.

**II. “Show your love for Me by obeying everything I’ve taught you,”
Jesus told His disciples.**

**“Love one another as I have loved You. I have loved you so much
that I am even going to suffer and die on the cross to be the Savior
you need. There is no greater love than that!”**

“Now, I want you to love each other that much, too!” Jesus told them.

**“And when you care for each other’s needs like this, others will know
that you really are My disciples and God’s people,” He promised
them.**



II. "Show your love for Me by obeying everything I've taught you," Jesus told His disciples. "Love one another as I have loved You. I have loved you so much that I am even going to suffer and die on the cross to be the Savior you need. There is no greater love than that! Now, I want you to love each other that much, too!" Jesus told them. "And when you care for each other's needs like this, others will know that you really care My disciples and God's people." He promised them.

12. Soon, everything happened just as Jesus said it would.

Soldiers came that night and arrested Jesus. The next day, Jesus suffered and died on the cross for the sins of God's people. Then, friends came for His body, wrapped it in sweet-smelling spices and clean, white linen, and buried Him in a cave grave.

It looked like it was the end for Jesus, but was it?



12. Soon, everything happened just as Jesus said it would. Soldiers came that night and arrested Jesus. The next day, Jesus suffered and died on the cross for the sins of God's people. Then, friends came for His body, wrapped it in sweet-smelling spices and clean, white linen, and buried Him in a cave grave. It looked like it was the end for Jesus, but was it?

13. No, it was not!

On Sunday, the third day, Jesus rose from the dead. He appeared to His disciples and taught them many things. Then He went up, up, up through the clouds to rule in heaven.

Jesus was gone. Was His help gone, too?

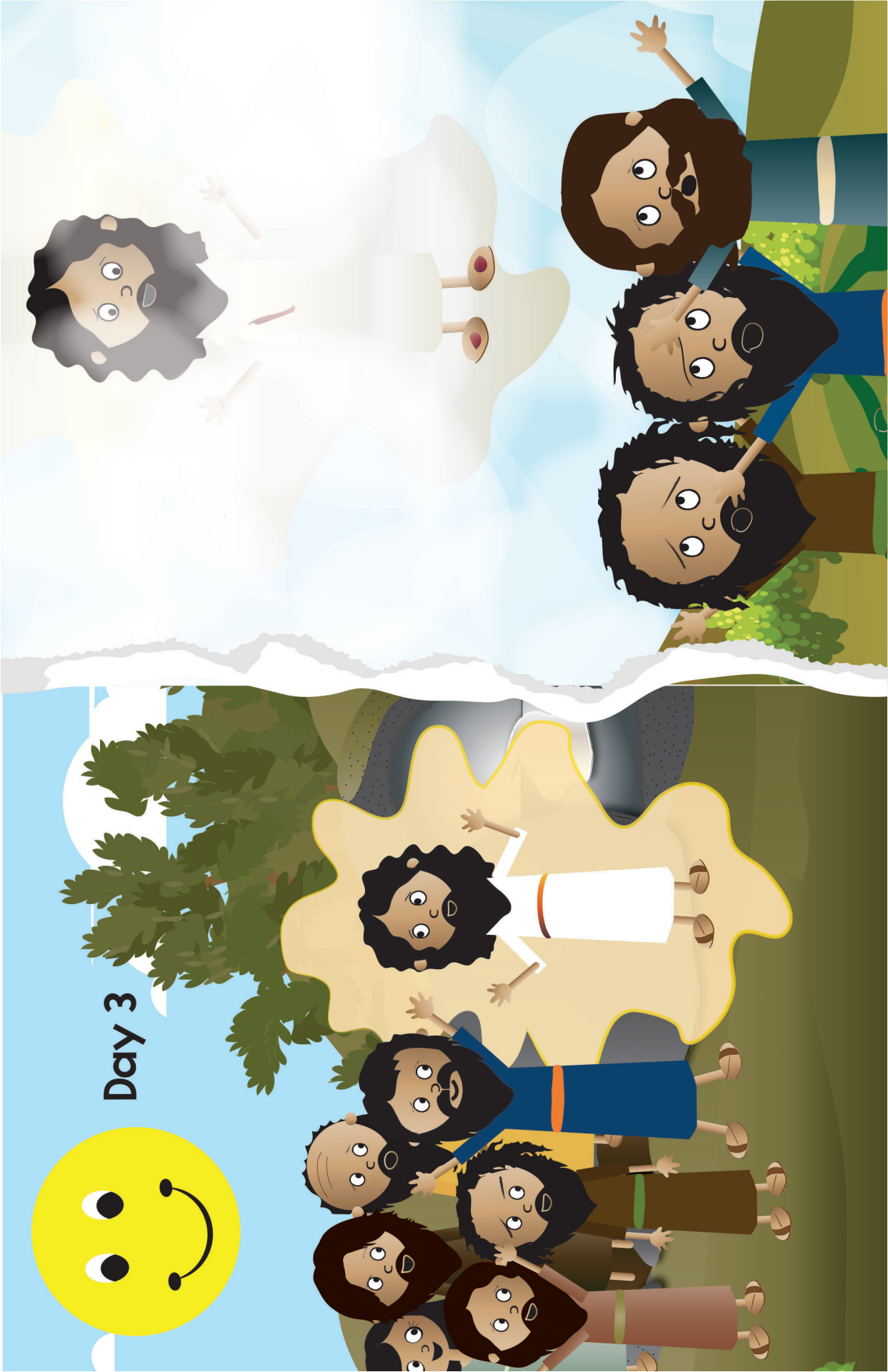

Day 3

13. No, it was not! On Sunday, the third day, Jesus rose from the dead. He appeared to His disciples and taught them many things. Then He went up, up, up through the clouds to rule in heaven. Jesus was gone. Was His help gone, too?

14. No, it was not!

Just as Jesus promised, He sent the Holy Spirit to live in the hearts of His disciples. And with the Holy Spirit's help, they lived out what Jesus had told them to do.

Holy Spirit



14. No, it was not! Just as Jesus promised, He sent the Holy Spirit to live in the hearts of His disciples. And with the Holy Spirit's help, they lived out what Jesus had told them to do.

15. “Love Me by obeying My commands! Love one another as I have loved you!” Jesus had told them.

So, they spread the good news in love. “Turn away from disobeying God. Trust in Jesus as your Savior. Be baptized,” they urged all who would listen.

The Holy Spirit worked in the hearts of many. The little church of Christians grew from 11 to 120 to over 3000 people in just a few weeks!



15. "Love Me by obeying My commands! Love one another as I have loved you!" Jesus had told them. So, they spread the good news in love. "Turn away from disobeying God. Trust in Jesus as your Savior. Be baptized," they urged all who would listen. The Holy Spirit worked in the hearts of many. The little church of Christians grew from 11 to 120 to over 3000 people in just a few weeks!

16. “Love Me by obeying My commands! Love one another as I have loved you!” Jesus had told them. So, the church gathered together in love: love for God and for each other.

Peter and Jesus’ other disciples led the believers as their pastors/elders. They preached from God’s Word. They comforted those who were scared and weak. They warned those who were forgetting how Jesus wanted them to live. They helped everyone live out Jesus’ commands. Their loving leadership was God’s good gift to His Church.



16. "Love Me by obeying My commands! Love one another as I have loved you!" Jesus had told them. So, the church gathered together in love: love for God and for each other. Peter and Jesus' other disciples led the believers as their pastors/elders. They preached from God's Word. They comforted those who were scared and weak. They helped those who were forgetting how Jesus wanted them to live. They helped everyone live out Jesus' commands. Their loving leadership was God's good gift to His Church.

17. Every day, and especially on Sundays, the little church gathered together.

As they gathered, the Holy Spirit worked in their hearts and encouraged them. They learned from God's Word. They fellowshiped and prayed together. They shared stories about the amazing things God was doing and urged each other to keep on loving God and living for Him.



17. Every day, and especially on Sundays, the little church gathered together. As they gathered, the Holy Spirit worked in their hearts and encouraged them. They learned from God's Word. They fellowshiped and prayed together. They shared stories about the amazing things God was doing and urged each other to keep on loving God and living for Him.

18. They ate the Lord's Supper together --the special meal of bread and wine that Jesus gave them to eat together to remember His death. They sang praised to their great God.

Oh, how they wanted to worship and love the LORD together, just as Jesus told them to! And the Holy Spirit helped them do this.



18. They ate the Lord's Supper together --the special meal of bread and wine that Jesus gave them to eat together to remember His death. They sang praised to their great God. Oh, how they wanted to worship and love the LORD together, just as Jesus told them to! And the Holy Spirit helped them do this.

19. But they didn't just worship and love the LORD. They loved one another like Jesus did, too.

And so, when they gathered together, they promised to care for each other's needs. Why, these believers shared everything they had with each other—food, clothes, houses, money... EVERYTHING! And if anyone needed anything, they would sell their things and buy whatever was needed.

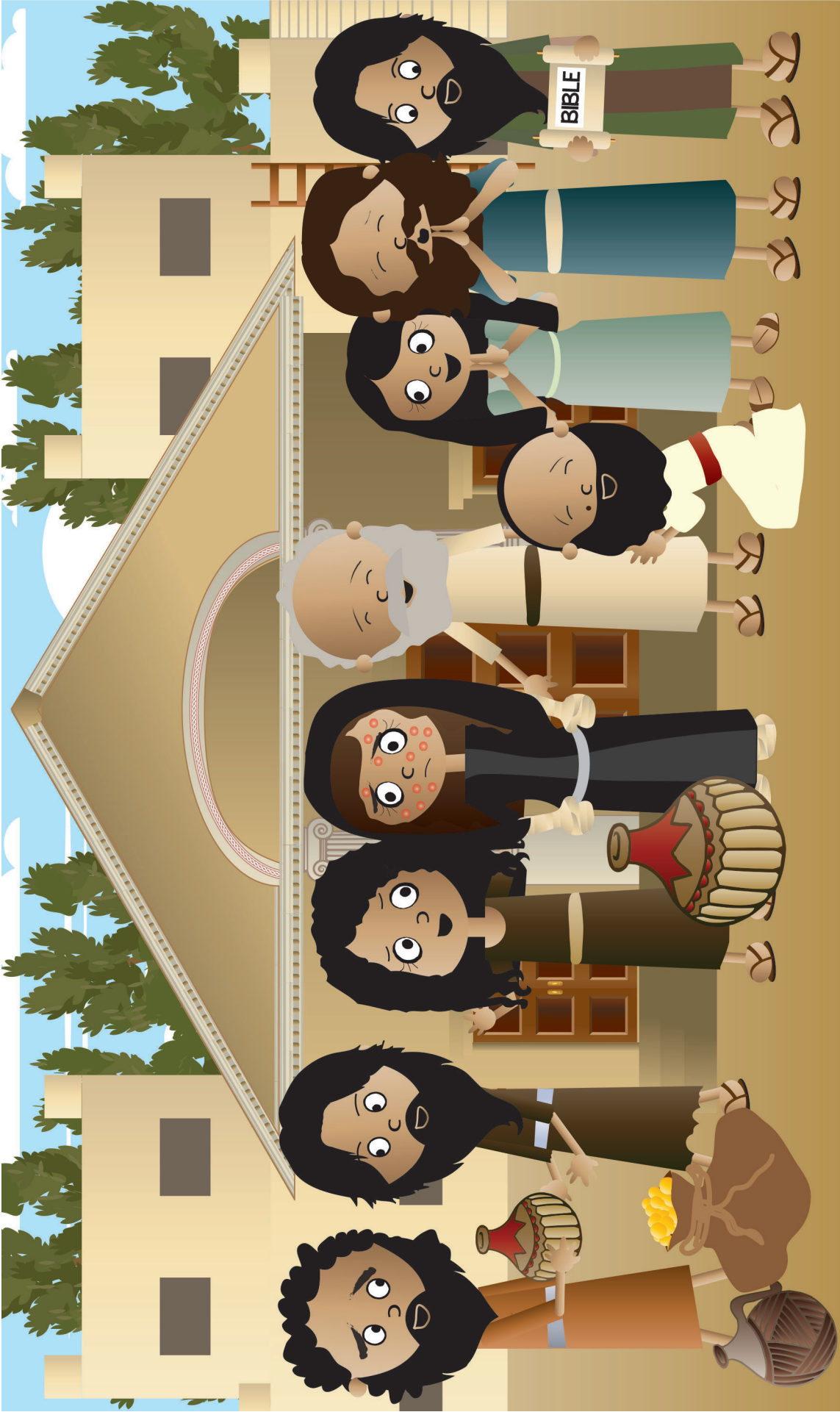

19. But they didn't just worship and love the LORD. They loved one another like Jesus did, too. And so, when they gathered together, they promised to care for each other's needs. Why, these believers shared everything they had with each other—food, clothes, houses, money... EVERYTHING! And if anyone needed anything, they would sell their things and buy whatever was needed.

20. Some people, like Stephen, Philip, and Phoebe were chosen by the church to be deacons.

These godly men and women led the little church in caring for the sick, old, and needy among them. They would make sure that no one was overlooked. Oh, how they wanted to love each other, as Jesus told them to! And with the help of God's Holy Spirit, they did.



20. Some people, like Stephen, Philip, and Phoebe were chosen by the church to be deacons. These godly men and women led the little church in caring for the sick, old, and needy among them. They would make sure that no one was overlooked. Oh, how they wanted to love each other, as Jesus told them to! And with the help of God's Holy Spirit, they did.

21. What glad and giving hearts those first Christians had! How they loved God and loved one another! And as they did, guess who else noticed? Everyone around them.

“Look at these people! How they love God and love one another! This is something very special,” they exclaimed. And so it was. For WHO did this church of believers look like, as they loved God and loved one another? Their Savior, Himself. Jesus!



21. What glad and giving hearts those first Christians had! How they loved God and loved one another! And as they did, guess who else noticed? Everyone around them. "Look at these people! How they love God and love one another! This is something very special," they exclaimed. And so it was. For WHO did this church of believers look like, as they loved God and loved one another? Their Savior, Himself. Jesus!

22. “If you like what you see in us, it’s because of Jesus!” the believers explained.

“He has saved us and filled us with His Holy Spirit. He’s the One changing our hearts, helping us love God and one another. Come gather with us! Let tell you about Jesus, and how you can become God’s people, too!” they exclaimed.



22. "If you like what you see in us, it's because of Jesus!" the believers explained. "He has saved us and filled us with His Holy Spirit. He's the One changing our hearts, helping us love God and one another. Come gather with us! Let tell you about Jesus, and how you can become God's people, too!" they exclaimed.

23. Many years have passed since those first believers gathered together. Some things have changed since those early days, but the most important things have not.

Jesus still calls His people to keep His commands and to love one another. He still wants them to share the good news of the gospel with everyone. And, He still wants them to gather together each week to worship God and love one another.

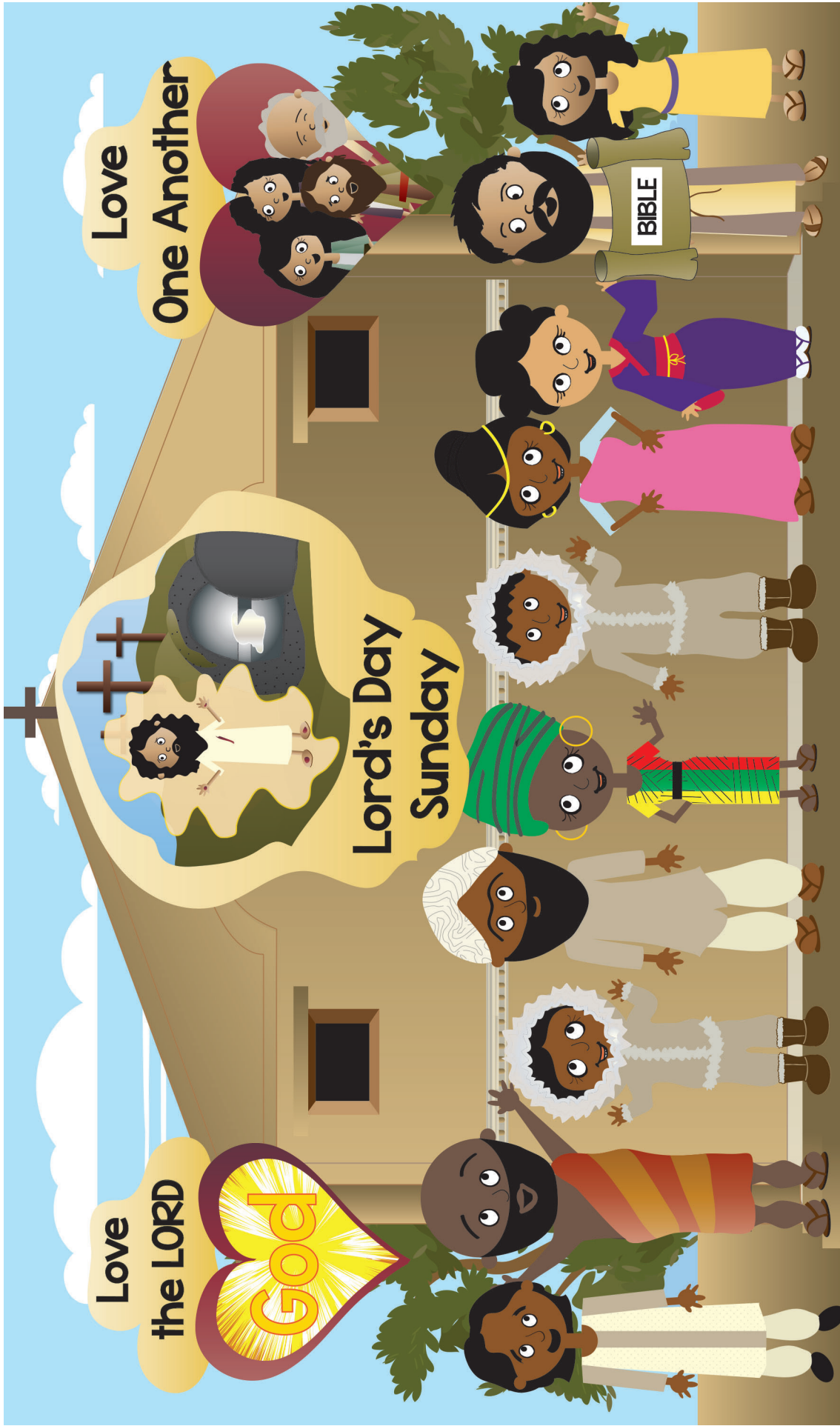

23. Many years have passed since those first believers gathered together. Some things have changed since those early days, but the most important things have not. Jesus still calls His people to keep His commands and to love one another. He still wants them to share the good news of the gospel with everyone. And, He still wants them to gather together each week to worship God and love one another.

24. And as they do, the Holy Spirit will keep on working in God's people, helping them look like Jesus to others.

"Tell us about Jesus who helps you love like this!" these people will say, and hopefully as they hear the good news of Jesus, they will trust in Him as their Savior, too!



24. And as they do, the Holy Spirit will keep on working in God's people, helping them look like Jesus to others. "Tell us about Jesus who helps you love like this!" these people will say, and hopefully as they hear the good news of Jesus, they will trust in Him as their Savior, too!

DDD 15.3 Simple Story Scenes

“The Case of the Copycats” John 13-15, 18-20; Acts

SOLVED

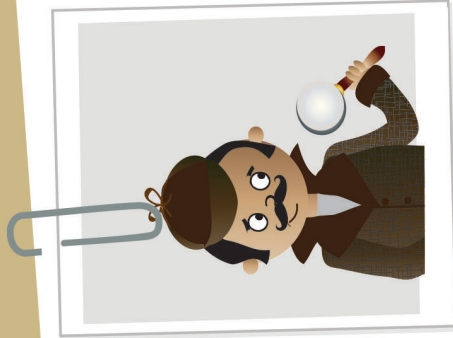

Detective Dan's Listening Assignment #1

A copycat is a nickname for someone who tries to act like someone else.

1. Who were the people who tried to act like someone else? Jesus' followers, God's people.
2. And who was the someone they try to act like? Why? They tried to act like Jesus by how they loved God and loved each other.

For You and Me:
God's people want to love each other as Jesus has loved them. They love being a part of God's care for His people. And, when God's people love like Jesus, they help others see what God is like, and be a part of God's plan to tell them the good news of Jesus. We can become God's people, too, when we turn away from our sins and trust in Jesus as our Savior. Then He will work in our hearts and help us love God and love others, too.



Detective Dan's Listening Assignment #2

John 13:34, ESV

“Love one another: just as I have loved you.”

1. What was Jesus' love for His people like? He chose to put their needs first. He loved them so much that He was willing to suffer and die in their place, for their sins. There is no greater love than this!
2. Who wanted to obey Jesus' command to love one another as He had loved them? Who helped them do this? Jesus' followers did. The Holy Spirit living in their hearts helped them.

For You and Me:

God's people want to love each other as Jesus has loved them. They love being a part of God's care for His people. And, when God's people love like Jesus, they help others see what God is like, and be a part of God's plan to tell them the good news of Jesus. We can become God's people, too, when we turn away from our sins and trust in Jesus as our Savior. Then He will work in our hearts and help us love God and love others, too.

DDD 15.3 Simple Story Scenes

Why Do God's People Go to Church?
To Worship God and Love One Another ...
By Caring for Each Other's Needs!

The Gospel

God's people love to tell others the good news of Jesus. Why? Because the greatest need we all have is for God to forgive their sins! You see, we all have chosen to disobey God. We deserve His punishment, not His love or to be His people.

But God, in His great mercy, sent His Son, Jesus, to be our Savior. Jesus lived a perfect life. Then, on the cross, He gave up His life as the full payment for the sins of God's people. On the third day, Jesus rose from the grave. He had beaten sin and death for God's people! Now, all who turn away from their sins and trust in Jesus as their Savior are forgiven. This is how we become God's people. Ask God to help you do this. He loves to answer this prayer!



DDD 15.3 Simple Story Scenes

A Prayer

A We praise You, God, for being the Savior of Your people, the Church. We praise You for Your kindness and love shown through Your people caring for each other.

C God, sometimes we don't want to go to church and care for the needs of others. Sometimes we just want to take care of our own needs. We need a Savior!

T Thank You, God, for giving Your people to each other to care for their needs. Thank You for all the people in church who care for our needs.

S God, work in our hearts. Help us to turn away from our sins and trust in Jesus as our Savior. Make us Your people! Help us to care for others when we gather at church.

In Jesus' name we pray. Amen.



DDD 15.3 Simple Story Scenes

DEEP DOWN DETECTIVES



Simple Story Scenes

Unit 15,

Bible Truth 4

Using Simple Story Scenes as a Curriculum

Introduce the Key Concept and Bible Verse

Simple Story Scenes give you the basics for the core of your lesson. You can use the overview sheet to introduce and explain the key concept and Bible verse.

Give the Case Assignment

Give the children a Detective Dan listening assignment. Two are provided. You can add a third using the ideas on the bonus, third take-home sheet, if desired. Each listening assignment, let's you teach the story with a different learning emphasis.

Show & Tell the Story

Hold up the pictures and tell the story from the story scenes. Alternatively, you can find in the and Pieces section for this unit at praisefactory.org, these same listening assignments and story scenes, gospel and ACTS prayer modified for view on a screen. Simply download them or open them online and show through your own monitor (tablet, big screen, whatever).

Solve the Case

Repeat Detective Dan's listening assignment question and discuss the answer.

Share the Gospel

Share the gospel tie-in with the kids.

Close in ACTS Prayer

Pray the ACTS prayer with the kids. If using the curriculum with older children, give them a chance to think up their own ACTS tie-ins to the story, using the one provided as cues/ideas for you.

Review Time

Give out the take-home sheet (there are three: two that correlates to the two Detective Dan assignments in the Story Scenes, and a bonus third one.) As the children are coloring, use the take-home sheet discussion questions or your own questions to further review and apply the key concepts, Bible verse, and story truths to the children.

Looking for more?

Online, in the Bits and Pieces section for this unit, you will find review games, crafts, storyboard flannelgraph figures, and audio and sheet music for all of the songs. There are also full lesson plans that offer more of a script and take this curriculum's possibilities to much more depth. Don't forget to tell the parents about the Parents Resources section where they can read through the Story scenes and download take homes with their kids.

Unit 15: God's People Gather Together**Unit Big Question (and Answer):** Why Do God's People Go to Church?

To Worship God and Love One Another!

Unit Bible Verse: "And let us consider how to stir up one another to love and good works, not neglecting to meet together." Hebrews 10:24-25, ESV**Bible Truth 4 Concept: To Worship God and Love One Another...****By Telling What God Has Done and Praying!**

When God's people gather together, they share with each other wonderful things God has done. They remind each other of the great things God did long ago in Bible times: how God always kept all His promises and did mighty things to save His people. They hear stories about how God has been at work around the world, bringing many other people to put their trust in Jesus as their Savior. They share with each other how God has been at work in their lives, caring for them and helping them live for Him. Oh, how faithful God has been to His people! Oh, how faithful God continues to be to them! All these stories of God's goodness and faithful helps them to keep on trusting God and living for Him.

But God's people don't just talk to each other about what God has done. They also talk to God about them! All these stories of them. They praise and thank Him for what He has done. They confess ways they have disobeyed Him and seek His forgiveness. They ask Him to do more great things, in their lives and around the world.

God delights in His people gathering together to pray. Jesus tells us in the Bible that when two or more of God's people are gathered together and praying that He will be there with them in a special way. Whether on their own or gathered together, God's people know God will always answer their prayers in the way He knows is best. We can become God's people, too, when we turn away from our sins and trust in Jesus as our Savior.

Bible Truth 4 Bible Verse: Ephesians 6:18, HCSB

"Pray at all times in the Spirit with every prayer and request, and stay alert in this with all perseverance and intercession for all the saints."

Learn a Little: "Pray at all times... for all the saints."**Meaning**

"Saints" is a big, Bible word for God's people. God's people pray when they gather together at church. They praise God and they confess their sins to Him. They thank Him for all the ways He has cared for them. They ask Him to do more great things and to help them to love Him and live for Him. There is so much to pray for!

Sometimes God's people get tired of praying. Sometimes God's plans take much longer than they want. It would be easy to stop praying and give up. But there's someone who helps God's people keep on interceding (a big Bible word for praying for others). Who is it? It's God, Himself. Yes, God's Holy Spirit is at work inside of each of them helping them even to talk to God. We can become God's people when we turn away from our sins and trust in Jesus as our Savior.

Bible Truth 4 ACTS Prayer

- A** We praise You, God, for saving Your people, the Church. We praise You for Your faithfulness to Your people throughout all time.
- C** God, sometimes we don't want to hear about all the wonderful things You've done for Your people. Sometimes, we don't want to pray for You to do more. We just want to think about ourselves and do what we want to do. We need a Savior!
- T** God, thank You for Your Word, the Bible, that tells us about the great things You did for Your people who lived long ago. Thank You for all You do for Your people today, all around the world. Thank You for letting us hear of Your mighty works, and for using them to help us to keep trusting in You and living for You. Thank You for hearing our prayers to do even more.
- S** God, work in our hearts. Help us to turn away from our sins and trust in Jesus as our Savior that we might become Your people. Help us to love hearing about the mighty things You have done, long ago and today. Help us to praise You more because of what You have done. Help us to trust You and live for You. Help us to encourage others who gather together with us. In Jesus' name we pray, Amen.

Bible Truth 4 Story

The Case of the Amazing Answer *Acts 12:1-18*

Songs Used in Bible Truth 4

Big Q & A 15 Song

Big Question 15 Song: Why Do God's People Go to Church?

Big Question 15 Bible Verse Song: Stir Up Hebrews 10:24-25, ESV

Big Question 15 Hymn: Brethren, We Have Met to Worship, v.1

Big Question 15 Praise Song: Praise the Lord Together

Bible Truth 4 Bible Verse: Pray, Pray, Pray Ephesians 6:18, HCSB

Bible Truth 4 Extra Bible Verse: Take Up the Whole Armor Ephesians 6:13,16-18, ESV

Bible Truth 4 Extra Bible Verse: Help Us 2 Corinthians 1:13, ESV

listen to or download songs for free at <https://praisefactory.org>: Deep Down Detectives Music page

“The Case of the Amazing Answer” Acts 12:1-18



Detective Dan's Listening Assignment #1

1. Who was in trouble? Who prayed for him?
2. What was God's amazing answer?



Detective Dan's Listening Assignment #2

Ephesians 6:18, HCSB

“Pray at all times in the Spirit with every prayer and request, and stay alert in this with all perseverance and intercession for all the saints.”

1. What kinds of things did God's people ask God to do?
2. How did God answer these prayers?

(more listening and discussion questions are included in the curriculum at praisefactory.org)

1. Life was exciting for Christians in the big city of Jerusalem. They told the good news of Jesus to all who would listen. Many people not only listened but believed! THOUSANDS of people had turned away from their sins and trusted in Him as their Savior, just weeks after Jesus had risen from the dead and gone to heaven!

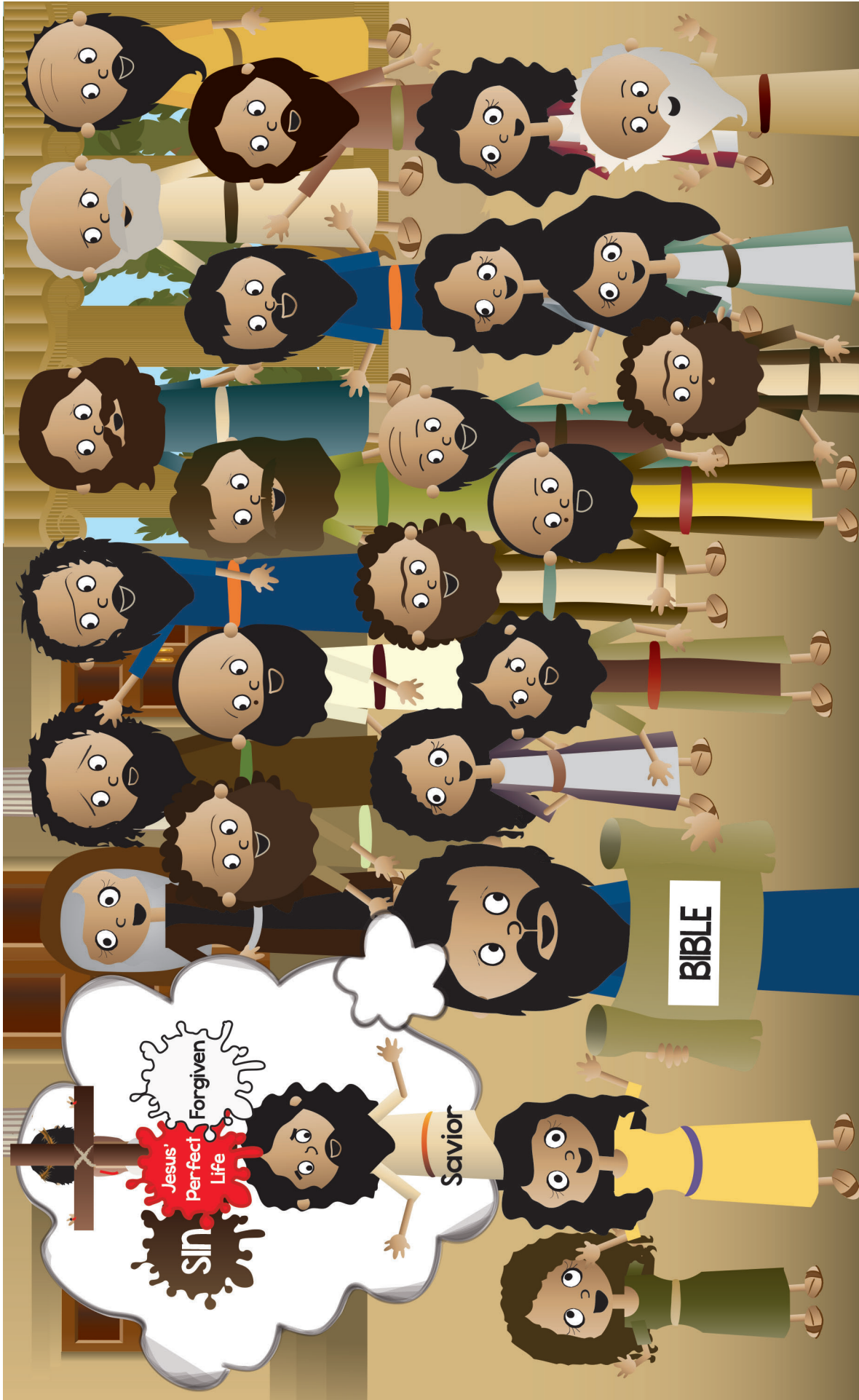

I. Life was exciting for Christians in the big city of Jerusalem. They told the good news of Jesus to all who would listen. Many people not only listened but believed! THOUSANDS of people had turned away from their sins and trusted in Him as their Savior, just weeks after Jesus had risen from the dead and gone to heaven!

2. These new believers joined the other Christians as they gathered together as a church.

This made the Christians so happy! They wanted everyone to be saved from God's punishment for their sins. They wanted everyone to worship God and love one another. How exciting it was to see the Holy Spirit work in the hearts of so many new people!

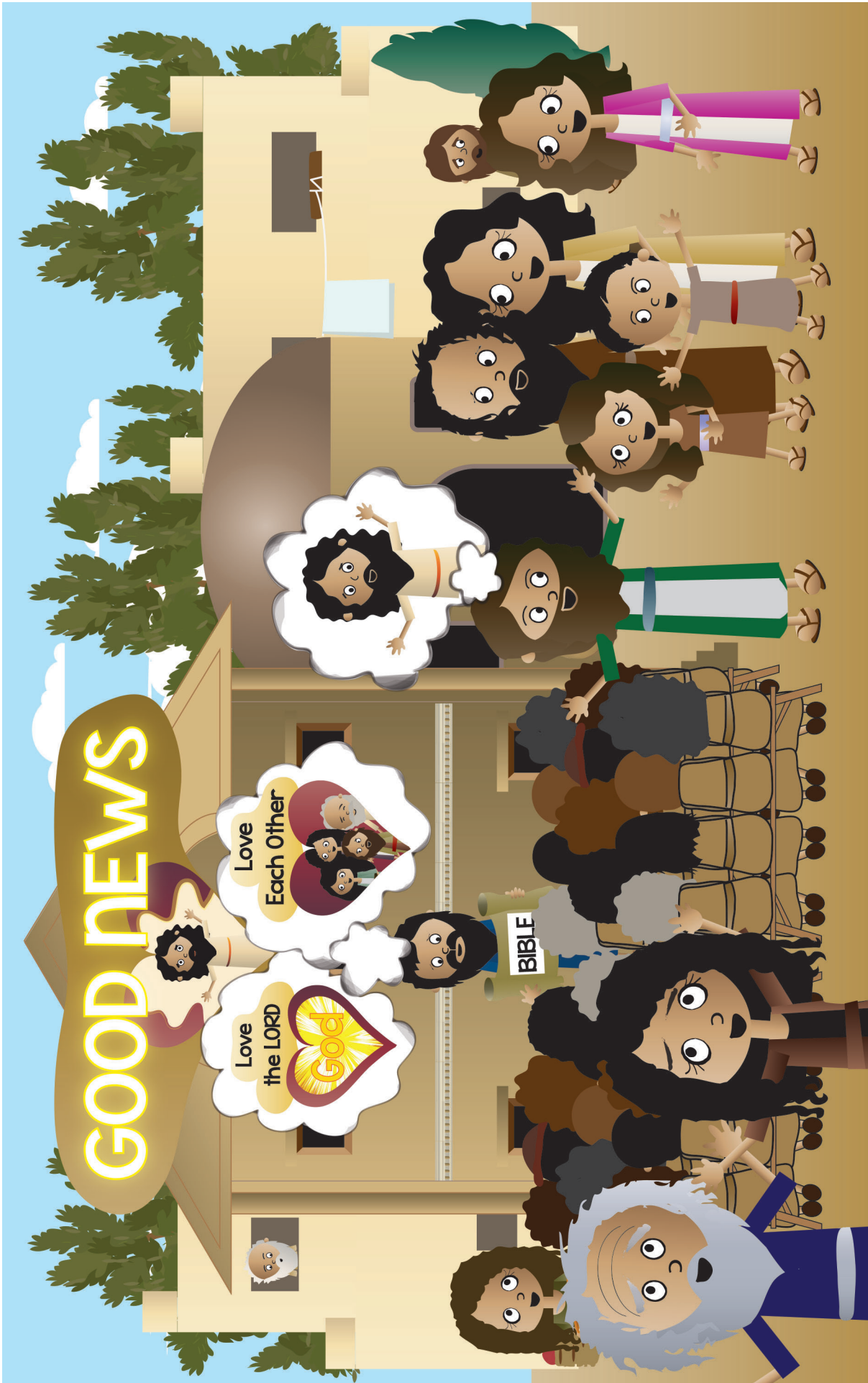

2. These new believers joined the other Christians as they gathered together as a church. This made the Christians so happy! They wanted everyone to be saved from God's punishment for their sins. They wanted everyone to worship God and love one another. How exciting it was to see the Holy Spirit work in the hearts of so many new people!

3. But life wasn't just EXCITING for these Christians. It was dangerous, too. For while the Christians were happy about all these new believers, there were others in Jerusalem who were very, very angry about it.

These enemies would do whatever they could to STOP more people from believing in Jesus. Perhaps angriest of all the angry people, were the important, Jewish leaders in Jerusalem. They did NOT believe that Jesus was God's Son, the Savior. They thought Jesus was just a fake.

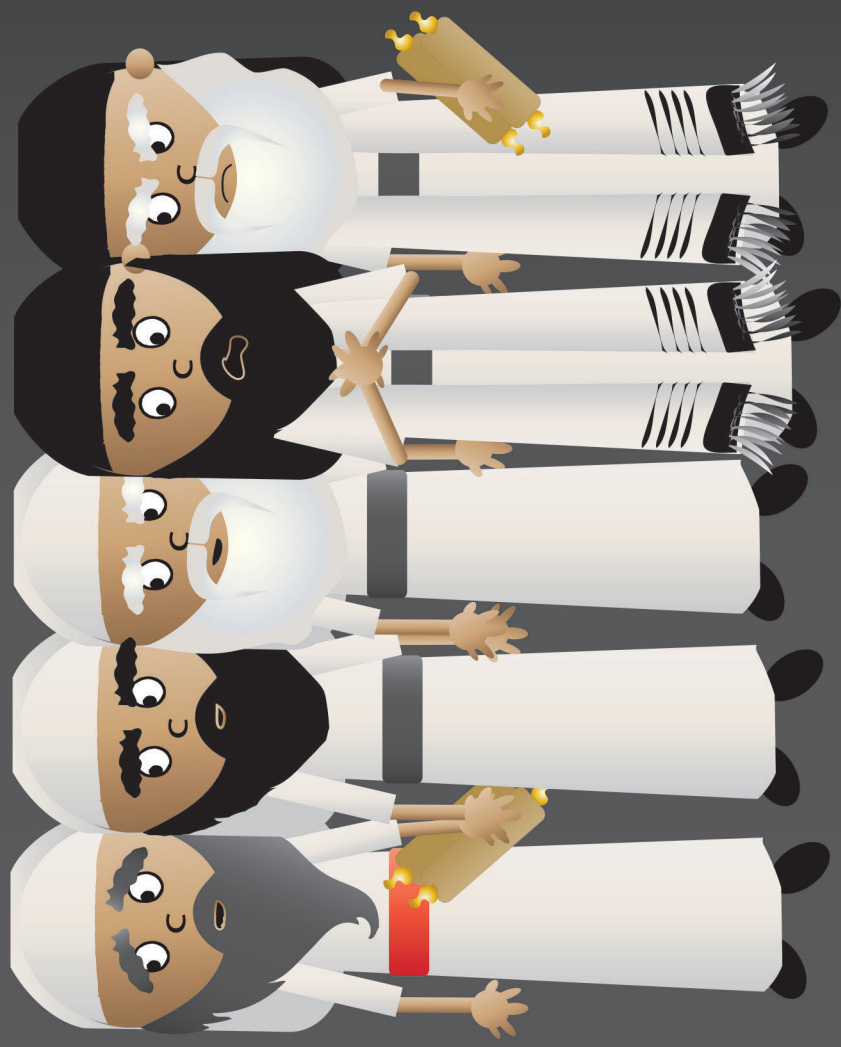
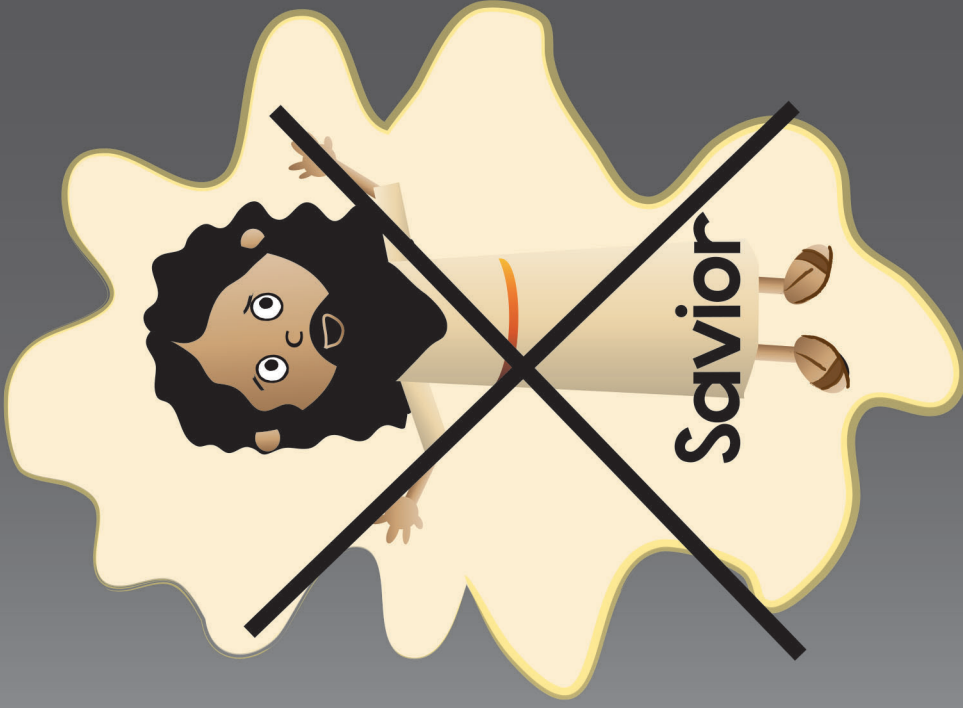

3. But life wasn't just **EXCITING** for these Christians. It was dangerous, too. For while the Christians were happy about all these new believers, there were others in Jerusalem who were very, very angry about it. These enemies would do whatever they could to **STOP** more people from believing in Jesus. Perhaps angriest of all the angry people, were the important, Jewish leaders in Jerusalem. They did **NOT** believe that Jesus was God's Son, the Savior. They thought Jesus was just a fake.

4. “We must stop those Christians from telling people about Jesus. They are ruining everything,” these important leaders told each other. And so, they began to send soldiers to hurt the Christians and put them in jail. They even began to kill some of them.



4. "We must stop those Christians from telling people about Jesus. They are ruining everything," these important leaders told each other. And so, they began to send soldiers to hurt the Christians and put them in jail. They even began to kill some of them.

5. But no matter what those leaders did, the Christians kept on doing the very things those important leaders did not want them to do.

They gathered together to worship God: they prayed together, listened to preaching from God's Word, the Bible, and shared with each other the amazing things God was doing.



5. But no matter what those leaders did, the Christians kept on doing the very things those important leaders did not want them to do. They gathered together to worship God: they prayed together, listened to preaching from God's Word, the Bible, and shared with each other the amazing things God was doing.

6. They gathered together to love one another, too.

They cared for each other's needs, making sure everyone had enough food, clothes, and anything else they needed. And when they left their church gatherings, what did they do? They kept on telling people about Jesus, that even more might be saved.

“GRRRR,” those important leaders were so mad! They must stop these Christians, but how? All Jerusalem waited to see what would happen.

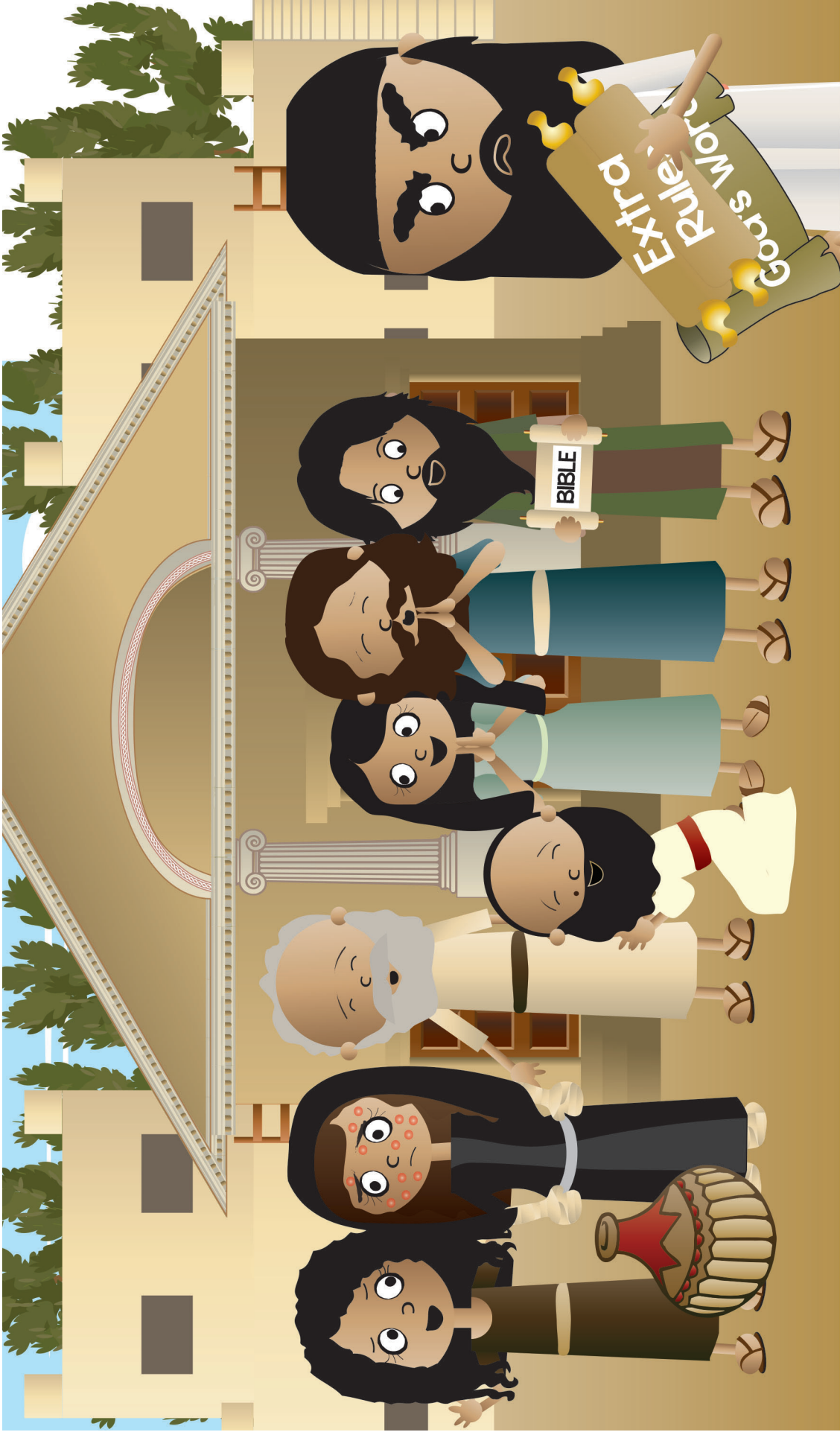

6. They gathered together to love one another, too. They cared for each other's needs, making sure everyone had enough food, clothes, and anything else they needed. And when they left their church gatherings, what did they do? They kept on telling people about Jesus, that even more might be saved. "GRRRR," those important leaders were so mad! They must stop these Christians, but how? All Jerusalem waited to see what would happen.

7. It didn't take long to find out.

Herod Agrippa, the Roman king over Jerusalem, had been looking for a way to make friends with the Jewish leaders. The people of Jerusalem didn't want a Roman king, and often disobeyed him. But if Herod could make the Jewish leaders happy, they could help the people be happy with him, too.

Getting rid of these Christians was just the chance he was looking for. So, King Herod sent his soldiers to arrest Christians. He even had them kill James, one of Jesus' first disciples! Oh, no!



7. It didn't take long to find out. Herod Agrippa, the Roman king over Jerusalem, had been looking for a way to make friends with the Jewish leaders. The people of Jerusalem didn't want a Roman king, and often disobeyed him. But if Herod could make the Jewish leaders happy, they could help the people be happy with him, too. Getting rid of these Christians was just the chance he was looking for. So, King Herod sent his soldiers to arrest Christians. He even had them kill James, one of Jesus' first disciples! Oh, no!

8. Now, the Christians were sad, and the Jewish leaders were happy. Herod liked this. His plan was working.

So, he decided to capture and maybe kill another, even more important leader of the Christians. You might even be able to guess his name. It starts with a “P” and he was one of Jesus’ closest friends.



8. Now, the Christians were sad, and the Jewish leaders were happy. Herod liked this. His plan was working. So, he decided to capture and maybe kill another, even more important leader of the Christians. You might even be able to guess his name. It starts with a “P” and he was one of Jesus’ closest friends.

q. It was Peter! Yes,

King Herod knew catching Peter would make those Jewish leaders really, REALLY happy! No telling what Herod could get them to do for him, if he got rid of Peter.

“Catch Peter and put him in jail,” King Herod ordered his soldiers. And that’s just what they did. They found Peter and locked him up.

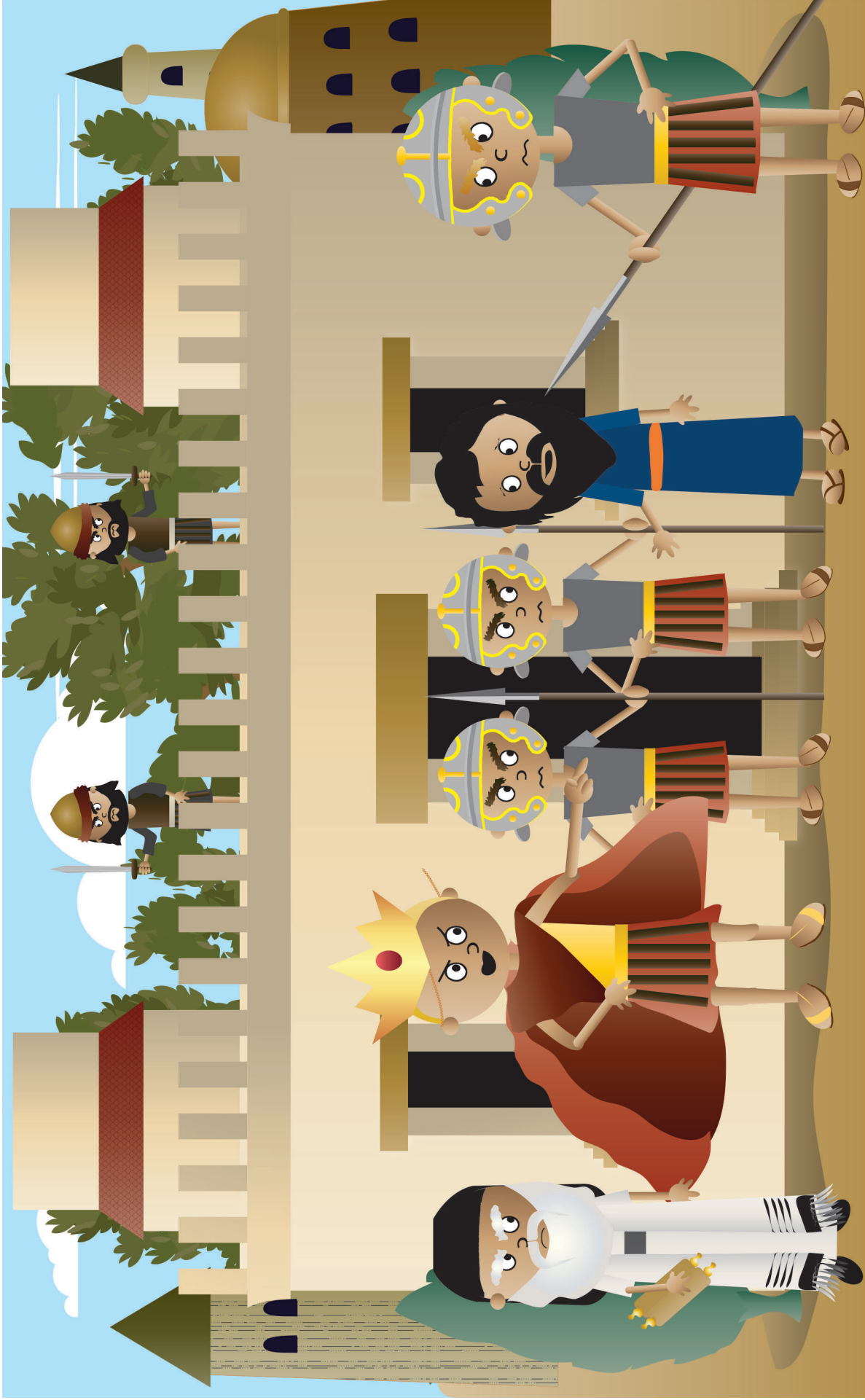

9. It was Peter! Yes, King Herod knew catching Peter would make those Jewish leaders really, REALLY happy! No telling what Herod could get them to do for him, if he got rid of Peter. "Catch Peter and put him in jail," King Herod ordered his soldiers. And that's just what they did. They found Peter and locked him up.

10. “Guard Peter carefully! Chain him to two soldiers,” the soldiers were told. “And put two extra soldiers outside the door of his jail room, just to be sure,” King Herod ordered. “We don’t want Peter to escape. I will bring him out to the people in a few days and decide what should happen to him then. Perhaps I will kill him like I did James,” Herod said.

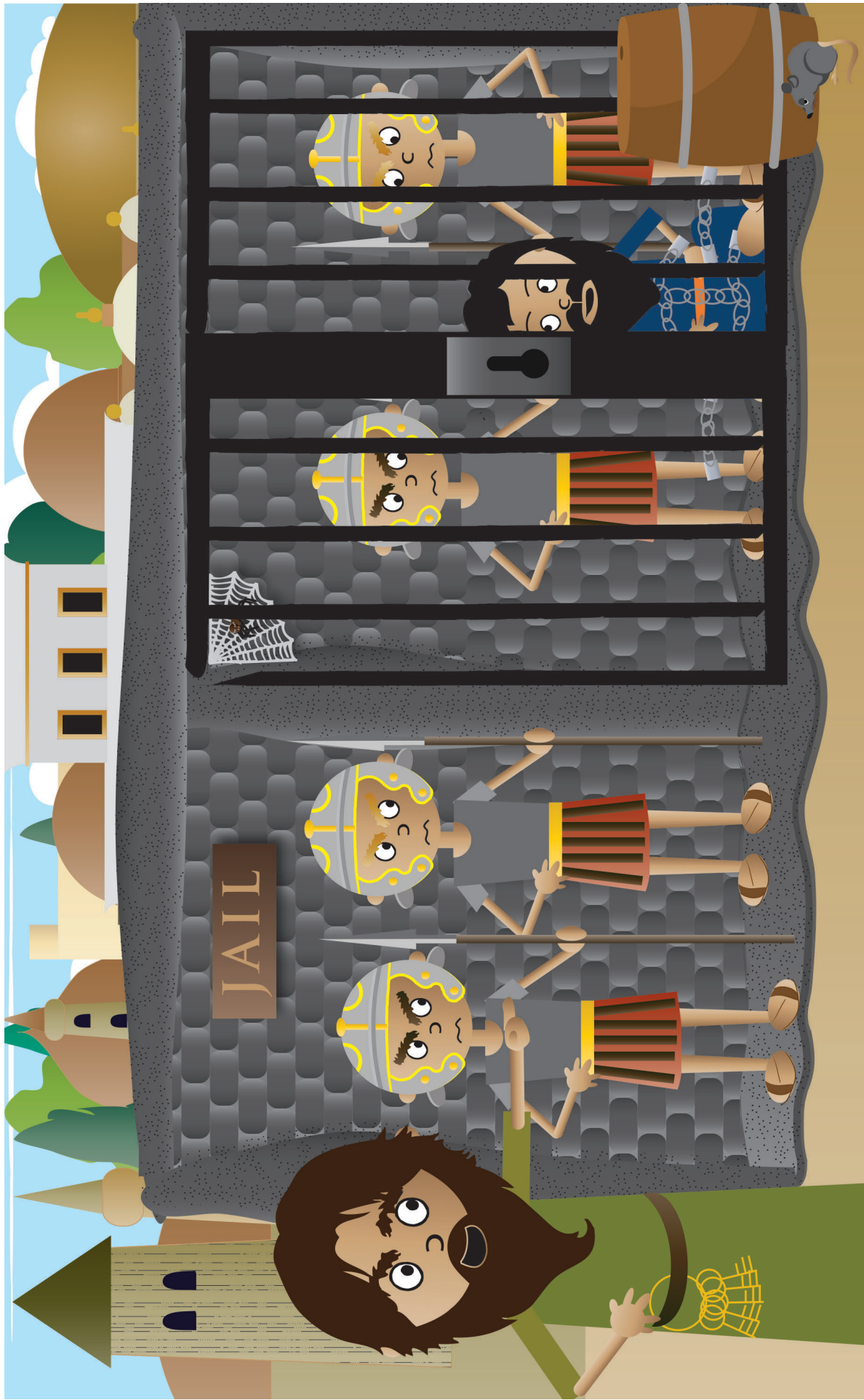

10. "Guard Peter carefully! Chain him to two soldiers," the soldiers were told. "And put two extra soldiers outside the door of his jail room, just to be sure," King Herold ordered. "We don't want Peter to escape. I will bring him out to the people in a few days and decide what should happen to him then. Perhaps I will kill him like I did James," Herod said.

II. What would the Christians do now? Their enemies were getting so strong. They had killed James, and now Peter was in jail.

What would they do if Herod killed him, too? Should they stop gathering together? Should they stop telling people about Jesus? No, they **SHOULDN'T! Could they try to get Peter out of jail? No, they **COULDN'T!****

Then, what **COULD they do???**

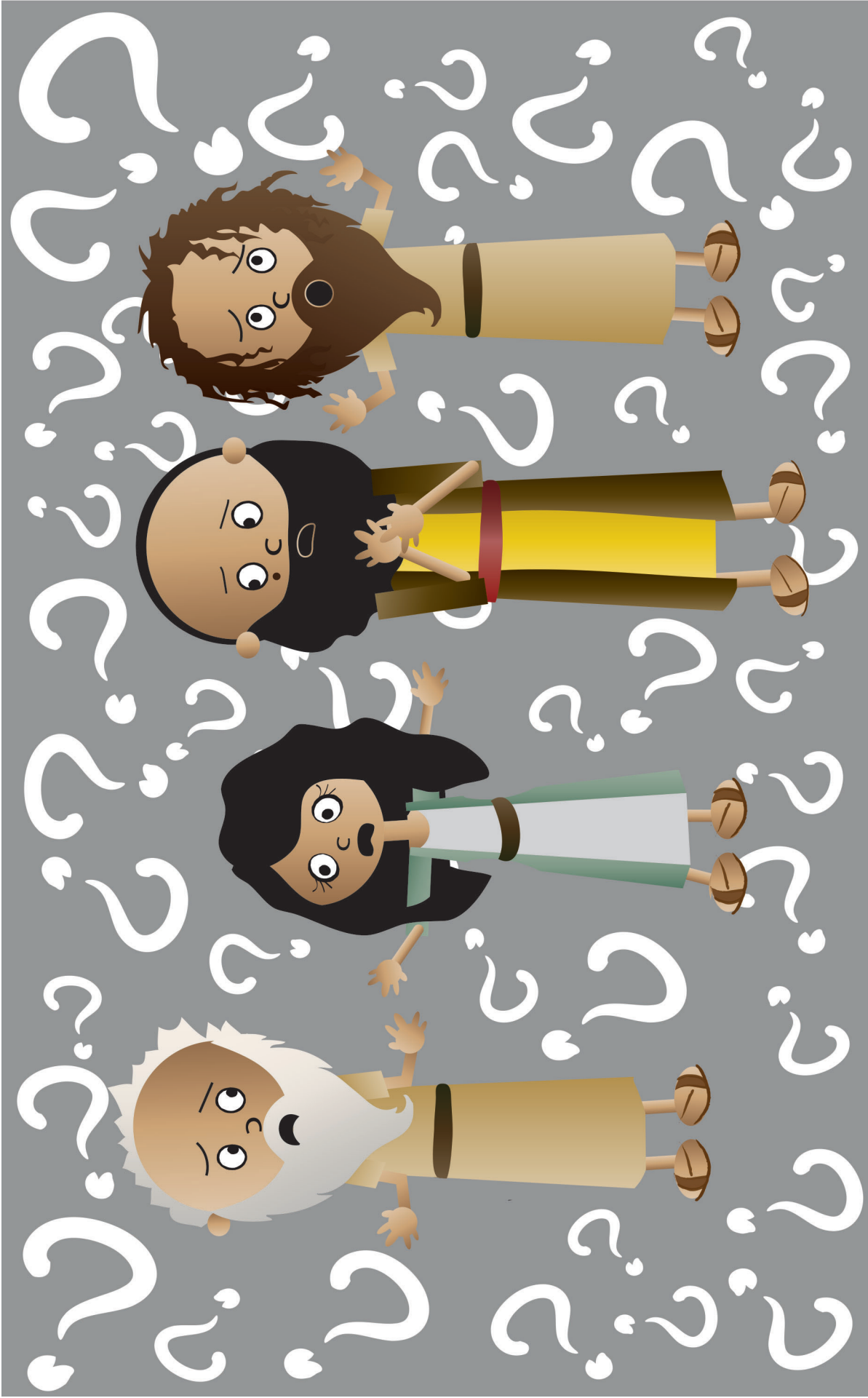

11. What would the Christians do now? Their enemies were getting so strong. They had killed James, and now Peter was in jail. What would they do if Herod killed him, too? Should they stop gathering together? Should they stop telling people about Jesus? No, they **SHOULDN'T!** Could they try to get Peter out of jail? No, they **COULDN'T!** Then, what **COULD** they do???

12. The believers knew what to do. They gathered together and asked for help from the One who could always help: the LORD!

THE LORD



12. The believers knew what to do. They gathered together and asked for help from the One who could always help: the LORD!

13. So, the believers gathered together and prayed and prayed.

“Please, God, make Peter bold and brave. Please, God, free him from jail. Please, God, help us to keep on telling people about Jesus,” they asked Him.



13. So, the believers gathered together and prayed and prayed. "Please, God, make Peter bold and brave. Please, God, free him from jail. Please, God, help us to keep on telling people about Jesus," they asked Him.

14. Day after day, night after night, Peter stayed in jail. Day after day, night after night, the little church of believers kept gathering together to pray for him. But still, nothing happened.

Didn't God hear them? Wasn't He listening? Didn't He care? Yes, God heard them. He was listening, and He cared. But, He was doing everything in His perfect way and in His perfect time.



14. Day after day, night after night, Peter stayed in jail. Day after day, night after night, the little church of believers kept gathering together to pray for him. But still, nothing happened. Didn't God hear them? Wasn't He listening? Didn't He care? Yes, God heard them. He was listening, and He cared. But, He was doing everything in His perfect way and in His perfect time.

15. At last, it was the very night before King Herod would bring Peter out, and probably kill him. Once again, the church gathered to pray, this time at Mary's house (the mother of John Mark).

"Please, God, make Peter bold and brave. Please, God, free him from jail. And please, God, help us to keep on telling people about Jesus," they prayed. And at last, God answered their prayers...



15. At last, it was the very night before King Herod would bring Peter out, and probably kill him. Once again, the church gathered to pray, this time at Mary's house (the mother of John Mark). "Please, God, make Peter bold and brave. Please, God, free him from jail. And please, God, help us to keep on telling people about Jesus," they prayed. And at last, God answered their prayers...

16. ...with a great, big, amazing YES! Let's see what God did.

YES!!!

16. ...with a great, big, amazing YES! Let's see what God did.

17. Deep in the jail, Peter slept, still tied to two soldiers with chains. Outside his jail room, two soldiers still kept guard. They wanted to make sure this night of all nights that Peter did not escape!

But suddenly, a light shone in the jail cell. God had sent someone to help Peter. Who could it be?

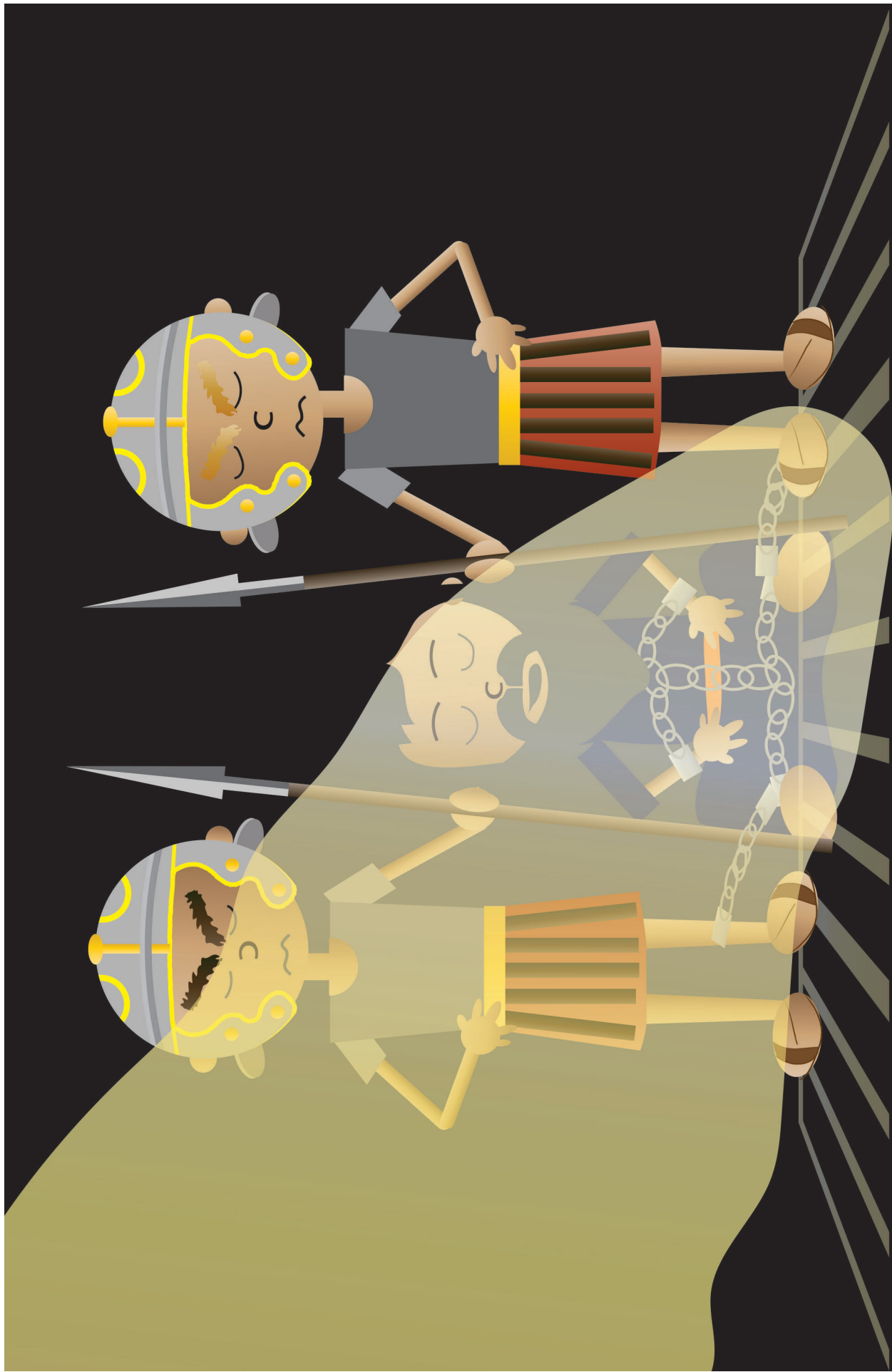

17. Deep in the jail, Peter slept, still tied to two soldiers with chains. Outside his jail room, two soldiers still kept guard. They wanted to make sure this night of all nights that Peter did not escape! But suddenly, a light shone in the jail cell. God had sent someone to help Peter. Who could it be?

18. It was an angel from heaven!

The angel struck Peter on the side and woke him saying, “Get up quickly!” “Clank!” off the chains fell from Peter’s hands and to the ground, by God’s power.

“Get dressed and put on your sandals,” the angel urged Peter. “Wrap your cloak around you and follow me.”



18. It was an angel from heaven! The angel struck Peter on the side and woke him saying, "Get up quickly!" "Clank!" off the chains fell from Peter's hands and to the ground, by God's power. "Get dressed and put on your sandals," the angel urged Peter. "Wrap your cloak around you and follow me."

19. Peter did just what the angel said. He got dressed, then followed the angel through the door, right past the guards, without anyone noticing them.

Then, “CREEAK!” the outer heavy, iron gate of the jail opened for them, all by itself. Peter and the angel passed through the gate and into the dark streets of Jerusalem. Isn’t God amazing!



19. Peter did just what the angel said. He got dressed, then followed the angel through the door, right past the guards, without anyone noticing them. Then, "CREEAK!" the outer heavy, iron gate of the jail opened for them, all by itself. Peter and the angel passed through the gate and into the dark streets of Jerusalem. Isn't God amazing!

20. Then, the angel left Peter as suddenly as he came.

Peter stood alone in the dark, amazed. The LORD had rescued him! He was free! Where should Peter go? What should Peter do? Who should Peter tell?

Peter knew EXACTLY where to go and what to do and who to tell! He would tell the other believers!



20. Then, the angel left Peter as suddenly as he came. Peter stood alone in the dark, amazed. The LORD had rescued him! He was free! Where should Peter go? What should Peter do? Who should Peter tell? Peter knew EXACTLY where to go and what to do and who to tell! He would tell the other believers!

21. Peter made his way through the dark streets to the house where the believers gathered to pray. Oh, no! The door was locked.

“Knock, knock!” Peter rapped on the door of the gateway until Rhoda, the servant girl came. “It’s me! Let me in!” Peter whispered to her.

“It’s Peter! It’s Peter! I know his voice! God has rescued him,” Rhoda exclaimed.

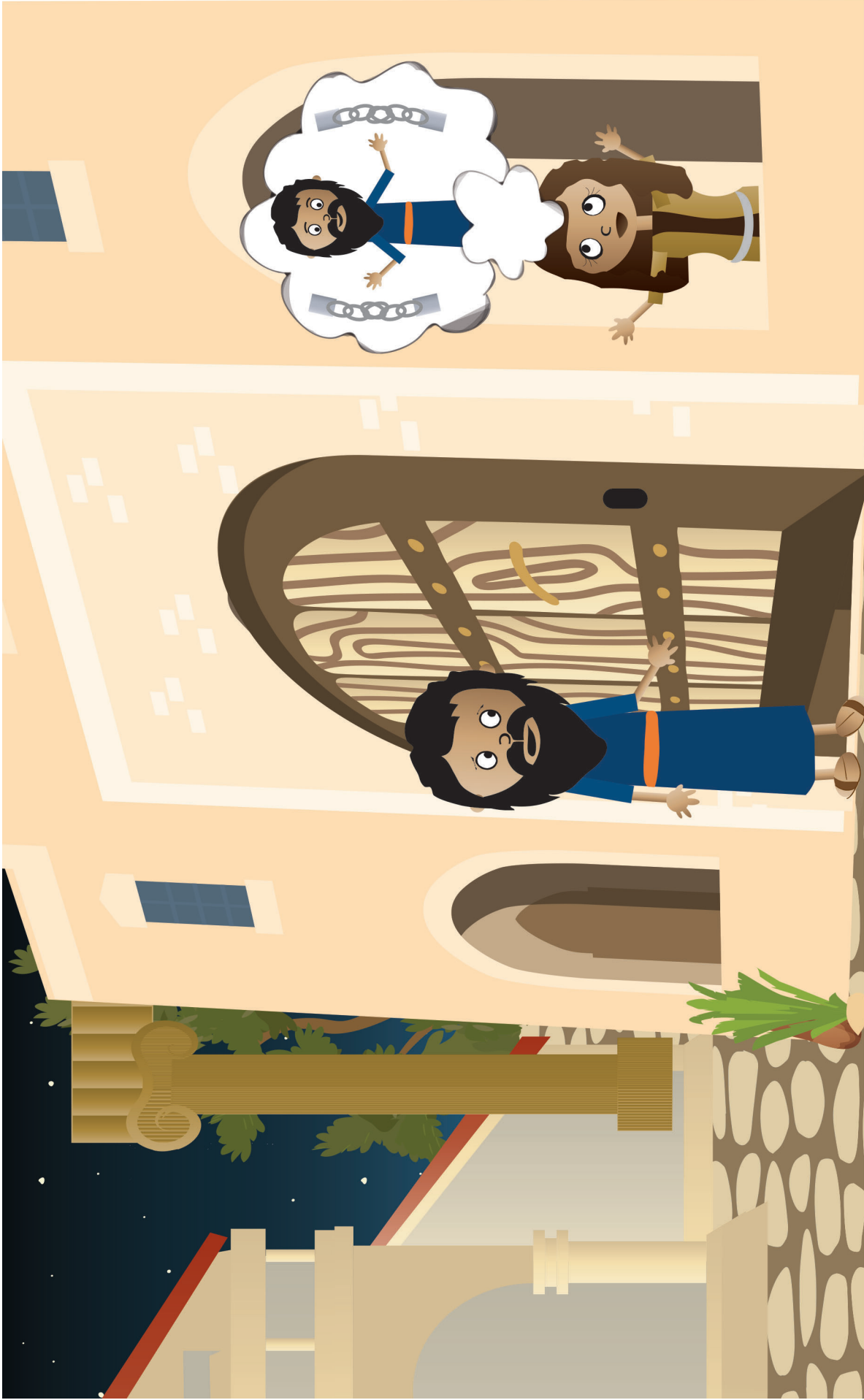

21. Peter made his way through the dark streets to the house where the believers gathered to pray. Oh, no! The door was locked. "Knock, knock!" Peter rapped on the door of the gateway until Rhoda, the servant girl came. "It's me! Let me in!" Peter whispered to her. "It's Peter! It's Peter! I know his voice! God has rescued him," Rhoda exclaimed.

22. Rhoda ran to tell to the others the good news, but was so excited that she forgot to let Peter in.

“You are crazy! It can’t be Peter! Peter is in jail!” they told her. How funny that the believers were praying for God to rescue Peter, but didn’t believe God had really done it!



22. Rhoda ran to tell to the others the good news, but was so excited that she forgot to let Peter in. "You are crazy! It can't be Peter! Peter is in jail!" they told her. How funny that the believers were praying for God to rescue Peter, but didn't believe God had really done it!

**23. But when Peter kept knocking, and at last, they opened the door.
It really WAS Peter!**

**Peter motioned for them to be quiet. He had escaped, but how long
would it be before his enemies would come looking for him? He
must be careful!**



23. But when Peter kept knocking, and at last, they opened the door. It really WAS Peter! Peter motioned for them to be quiet. He had escaped, but how long would it be before his enemies would come looking for him? He must be careful!

24. Then, Peter shared with the little church the amazing way God had answered their prayers.

**No enemy could stop God's people with God answering their prayers!
God's plans would always win! How they all praised God that night
for all the amazing things that He had done!**

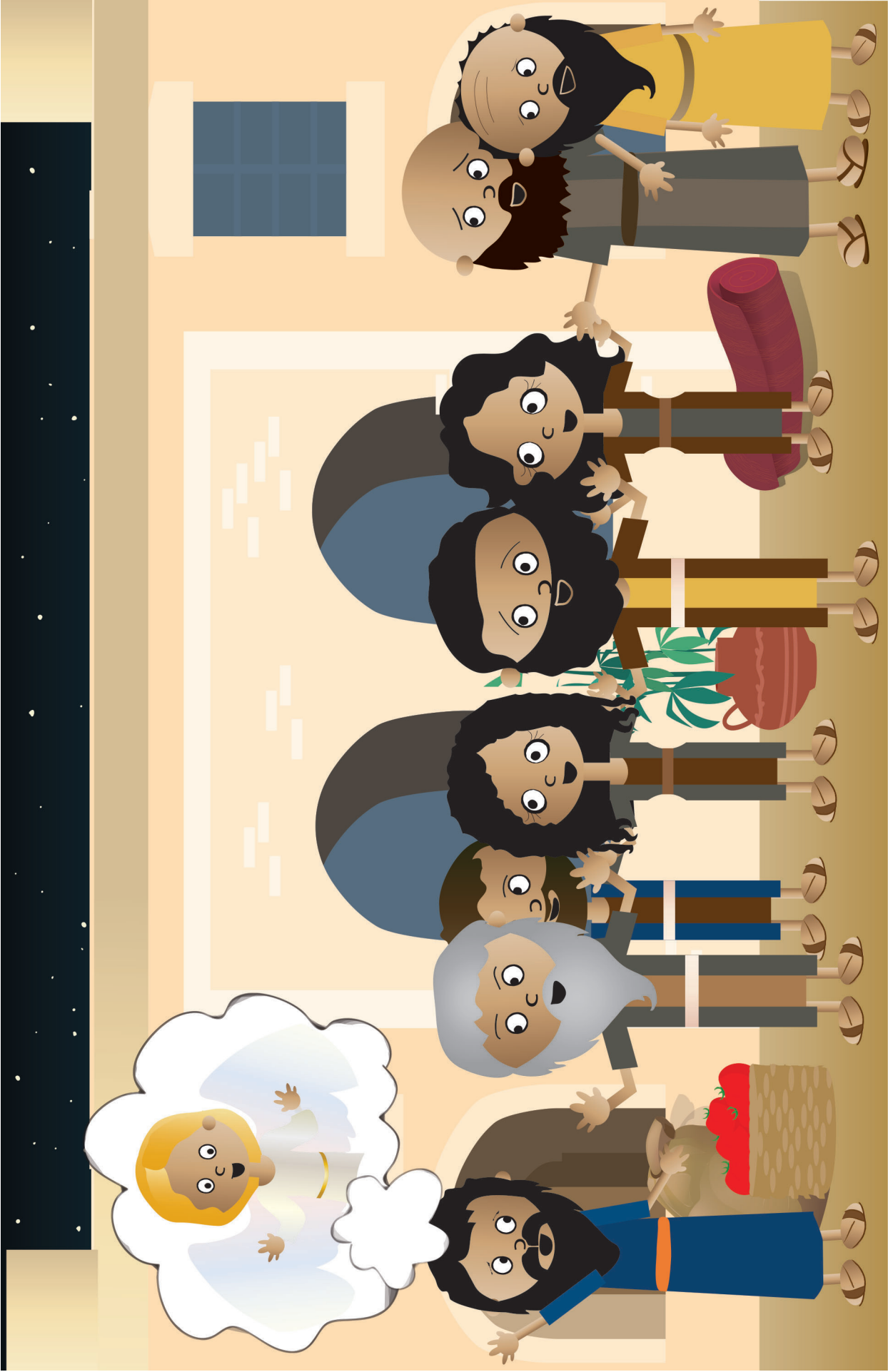

24. Then, Peter shared with the little church the amazing way God had answered their prayers. No enemy could stop God's people with God answering their prayers! God's plans would always win! How they all praised God that night for all the amazing things that He had done!

DDD 15.4 Simple Story Scenes

“The Case of the Amazing Answer” Acts 12:1-18

SOLVED



Detective Dan's Listening Assignment #1

1. Who was in trouble? Who prayed for him? Peter was in trouble. The little church of believers prayed for him to be rescued.

2. What was God's amazing answer? God sent an angel to free Peter from jail and bring him safely back to them.

For You and Me:
God is the same God today as He was back in Bible times. He wants His people to keep on asking Him to do amazing things. One of the first amazing things we can ask Him to do is help us turn away from our sins and trust in Jesus as our Savior. This is how we become God's people. God loves to answer this prayer and many other ones just as amazing!

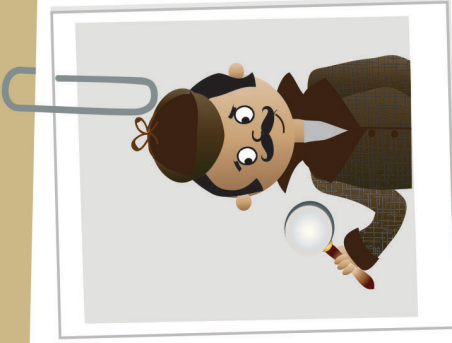

Detective Dan's Listening Assignment #2

Ephesians 6:18, HCSB

“Pray at all times in the Spirit with every prayer and request, and stay alert in this with all perseverance and intercession for all the saints.”

1. What kinds of things did God's people ask God to do? To rescue Peter from being killed.

2. How did God answer these prayers? God sent an angel to free him from jail and bring him safely back to them.

For You and Me:
God is the same God today as He was back in Bible times. He wants His people to keep on asking Him to do amazing things. One of the first amazing things we can ask Him to do is help us turn away from our sins and trust in Jesus as our Savior. This is how we become God's people. God loves to answer this prayer and many other ones just as amazing!

DDD 15.4 Simple Story Scenes

Why Do God's People Go to Church?
To Worship God and Love One Another...
By Telling What God Has Done and Praying!

The Gospel

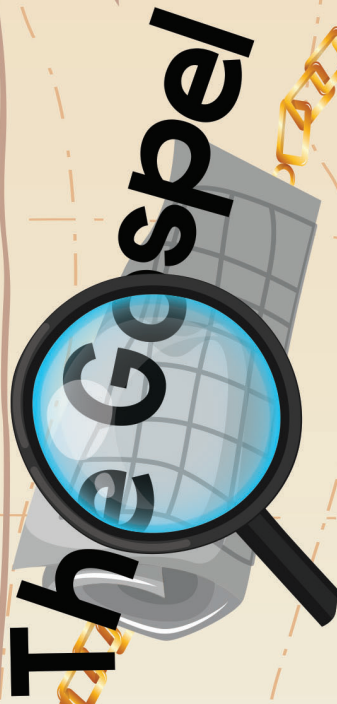

God's people love to tell the good news of what God has done in Jesus. You see, we have all disobeyed God and deserve His punishment. But God, in His great mercy, has provided us a way for our sins to be forgiven and to become His people through Jesus.

Jesus lived a perfect life. On the cross, He chose to suffer and die, giving up His life as the full payment for the sins of God's people. On the third day, Jesus rose from the grave. He had beaten sin and death for God's people!

Now, all who turn away from their sins and trust in Jesus as their Savior receive God's forgiveness. This is how we become God's people. Ask God to help you do this, too. He loves to answer this prayer.



DDD 15.4 Simple Story Scenes

A Prayer

A We praise You, God, for saving Your people, the Church. We praise You for Your faithfulness to Your people throughout all time.

C God, sometimes we don't want to hear about all the wonderful things You've done. Sometimes, we don't want to pray for You to do more. We just want to think about ourselves and do what we want to do. We need a Savior!

T God, thank You for Your Word, the Bible, that tells us about the great things You did for Your people who lived long ago. Thank You for all You do for Your people today, all around the world. Thank You for letting us hear of Your mighty works, and for using them to help us to keep trusting in You and living for You. Thank You for hearing our prayers to do even more.

S God, work in our hearts. Help us to turn away from our sins and trust in Jesus as our Savior that we might become Your people. Help us to praise You more because of what You have done. Help us to encourage others who gather together with us.

In Jesus' name we pray, Amen.



DDD 15.4 Simple Story Scenes

DEEP DOWN DETECTIVES



Simple Story Scenes

Unit 15,

Bible Truth 5

Using Simple Story Scenes as a Curriculum

Introduce the Key Concept and Bible Verse

Simple Story Scenes give you the basics for the core of your lesson. You can use the overview sheet to introduce and explain the key concept and Bible verse.

Give the Case Assignment

Give the children a Detective Dan listening assignment. Two are provided. You can add a third using the ideas on the bonus, third take-home sheet, if desired. Each listening assignment, let's you teach the story with a different learning emphasis.

Show & Tell the Story

Hold up the pictures and tell the story from the story scenes. Alternatively, you can find in the and Pieces section for this unit at praisefactory.org, these same listening assignments and story scenes, gospel and ACTS prayer modified for view on a screen. Simply download them or open them online and show through your own monitor (tablet, big screen, whatever).

Solve the Case

Repeat Detective Dan's listening assignment question and discuss the answer.

Share the Gospel

Share the gospel tie-in with the kids.

Close in ACTS Prayer

Pray the ACTS prayer with the kids. If using the curriculum with older children, give them a chance to think up their own ACTS tie-ins to the story, using the one provided as cues/ideas for you.

Review Time

Give out the take-home sheet (there are three: two that correlates to the two Detective Dan assignments in the Story Scenes, and a bonus third one.) As the children are coloring, use the take-home sheet discussion questions or your own questions to further review and apply the key concepts, Bible verse, and story truths to the children.

Looking for more?

Online, in the Bits and Pieces section for this unit, you will find review games, crafts, storyboard flannelgraph figures, and audio and sheet music for all of the songs. There are also full lesson plans that offer more of a script and take this curriculum's possibilities to much more depth. Don't forget to tell the parents about the Parents Resources section where they can read through the Story scenes and download take homes with their kids.

Unit 15: God's People Gather Together**Unit Big Question (and Answer):** Why Do God's People Go to Church?

To Worship God and Love One Another!

Unit Bible Verse: "And let us consider how to stir up one another to love and good works, not neglecting to meet together." Hebrews 10:24-25, ESV**Bible Truth 5 Concept: To Worship God and Love One Another... By Baptizing People Who Trust in and Live for Jesus!**

Jesus told His disciples to baptize everyone who turns away from their sins and trusts in Him as their Savior. Baptism is a picture of the new life that begins when someone becomes a Christian. God has forgiven their sins and made them His people. God has filled their hearts with His Holy Spirit and made it new. They are leaving their old life behind and beginning a new life of living for Jesus.

Not just anyone gets baptized. Baptism is a big deal. The godly leaders at church want to make sure that the person being baptized really understands the good news of Jesus and what it means to live as one of God's people. Sometimes a person is ready to be baptized very soon. But sometimes, the leaders think it's best if the person has more time to make sure that they really understand the good news of Jesus and are ready to live it out. It may not feel good to be told to wait, but the leaders want to do what's best for this person and what's best for the church.

On baptism day, God's people gather together to watch, pray and celebrate. The person being baptized stands up and shares the story of how he came to trust in Jesus as his Savior. He tells of his desire to live God's way and to gather together with God's people.

Then at last, it's baptism time! The new believer wades into the water with one of the pastors. The pastor holds onto the person as they lean back into the water for a few seconds. This is to remember that Jesus died and was buried for their sins. It's a picture that their old life of disobeying God is over. That life died with Jesus. Then, the pastor helps him/her come up out of the water. This reminds them that Jesus rose from the dead for them. He completely paid God's punishment for the sins. He has forgiven them once and for all. With God's help, they are beginning a new life of knowing, loving and obeying God. Often, everyone claps and cheers as the new believer comes up out of the water. They are so happy that someone else is telling the world that they are one of God's people and want to live for Him forever. We can become one of God's people when we turn away from our sins and trust in Jesus as our Savior.

Bible Truth 5 Bible Verse: Acts 2:38, ESV

"Repent and be baptized every one of you in the name of Jesus Christ for the forgiveness of your sins."

Learn a Little: "Repent and be baptized in the name of Jesus Christ."**Meaning:**

What a wonderful gift God has given us in Jesus! Through Him, we can be forgiven our sins and can become God's people forever. What do we have to do to receive this gift? Repent of our sins (that is, turning away from wanting to disobey God and live for Him instead) and trust in Jesus as our Savior. God promises to save all who come to Him like this! And what happens when someone does this? God hears his prayers and forgives him. God puts His Holy Spirit in their heart and they begin a whole new life with God.

God wants all who repent and believe in Jesus to be baptized as a special sign to everyone of what has happened inside their heart. Their old way of living is gone. They are forgiven! They are saved! And now they belong to God and live for Him! Have you ever been to a baptism?

We can become one of God's people, too, when we turn away from our sins and trust in Jesus as our Savior.

Bible Truth 5 ACTS Prayer

- A** We praise You, God, for saving Your people, the Church, through Jesus. He is why we can become Your people.
- C** God, we know that we can never become Your people on our own. We have all turned away from You and Your good ways. We need a Savior!
- T** God, thank You for providing the way for us to become Your people through Jesus. Thank You for giving a new life to all who turn away from their sins and trust in Him. Thank You for giving us baptism to help us remember the new way of life You give to all who do this.
- S** God, work in our hearts. Help us to turn away from our sins and trust in Jesus as our Savior. Help us to one day be able to stand before God's people and tell the story of how You saved us. Help us to trust our leaders to know when we are ready to be baptized and when we need to still wait and grow. In Jesus' name we pray, Amen.

Bible Truth 5 Story

The Case of the Up and Down Sign *Matthew 28; Acts 1-2, 8:35-36, 10:47, 16:14-15,31-34*

Songs Used in Bible Truth 5

Big Q & A 15 Song

Big Question 15 Song: Why Do God's People Go to Church?

Big Question 15 Bible Verse Song: Stir Up Hebrews 10:24-25, ESV

Big Question 15 Hymn: Brethren, We Have Met to Worship, v.1

Big Question 15 Praise Song: Praise the Lord Together

Bible Truth 5 Bible Verse: Repent, Repent and Be Baptized Acts 2:38-39, ESV

Extra Bible Truth 5 Bible Verse: The Time Is Fulfilled Mark 1:15, ESV

Extra Bible Truth 5 Bible Verse: The Time Mark 1:15, ESV

listen to or download songs for free at <https://praisefactory.org>: Deep Down Detectives Music page

“The Case of the Up and Down Sign” Matthew 28; Acts 1-2, 8:35-36, 10:47, 16:14-15, 31-34

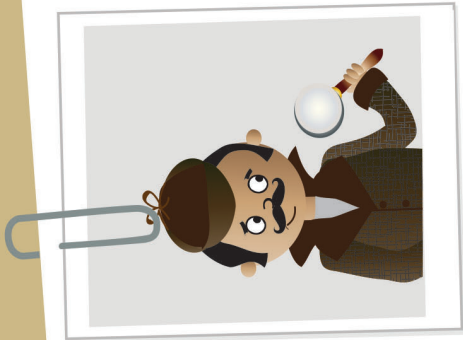

Detective Dan's Listening Assignment #1

1. What did Jesus tell new believers to do as a sign of their new life in God?
2. Why did they go up and down in the water when they did this special sign?



Detective Dan's Listening Assignment #2

Acts 2:38, ESV

“Repent and be baptized every one of you in the name of Jesus Christ for the forgiveness of your sins.”

1. Who repented of their sins? How did their lives look different?
2. What did they do as a sign that their lives had changed?

(more listening and discussion questions are included in the curriculum at praisefactory.org)

I. “Wait, then go!” Jesus told His disciples.

“WAIT in Jerusalem until you receive God’s Holy Spirit. He will live in your hearts and will give you the power to do everything God wants you to do,” Jesus told them.

WAIT!



I. "Wait, then go!" Jesus told His disciples. "WAIT in Jerusalem until you receive God's Holy Spirit. He will live in your hearts and will give you the power to do everything God wants you to do," Jesus told them.

2. “Then GO! Go into all the world, to all peoples, everywhere. Tell them about Me,” Jesus told His disciples.

“Tell them to turn away from disobeying God and trust in Me as their Savior. Teach them everything I’ve taught you. Baptize these new believers. This tells everyone that they are God’s people and My disciples. They are choosing to turn away from their old life and now live to please God, instead,” Jesus said.



2. "Then GO! Go into all the world, to all peoples, everywhere. Tell them about Me," Jesus told His disciples. "Tell them to turn away from disobeying God and trust in Me as their Savior. Teach them everything I've taught you. Baptize these new believers. This tells everyone that they are God's people and My disciples. They are choosing to turn away from their old life and now live to please God, instead," Jesus said.

3. “You won’t see Me anymore. I’m going to heaven now,” Jesus told His disciples. “But I still will be with you always until I return to earth, at the end of time,” He promised.

And that’s just what happened. Jesus went up to heaven, and His disciples went back to Jerusalem to wait for the Holy Spirit. And wait, they did. One day, two days, three days, a week, even nine days! Still no Holy Spirit!

Would He ever come? Had Jesus forgotten His promise?

1, 2, 3, 4, 5, 6, 7, 8, 9 Days



3. "You won't see Me anymore. I'm going to heaven now," Jesus told His disciples. "But I still will be with you always until I return to earth, at the end of time." He promised. And that's just what happened. Jesus went up to heaven, and His disciples went back to Jerusalem to wait for the Holy Spirit. And wait, they did. One day, two days, three days, a week, even nine days! Still no Holy Spirit! Would He ever come? Had Jesus forgotten His promise?

4. NO, Jesus had not forgotten. YES, the Holy Spirit would come! He was waiting for the perfect time: DAY 10, the Day of Pentecost.

Suddenly, “Whoosh,” there was a sound like a great wind in the room. Then, “Sparkle, sparkle,” something that looked like flames of fire appeared over their heads. After this grand announcement, the Holy Spirit came quietly to live in the hearts of all the believers who gathered together that day.



4. NO, Jesus had not forgotten. YES, the Holy Spirit would come! He was waiting for the perfect time: DAY 10, the Day of Pentecost. Suddenly, “Whoosh,” there was a sound like a great wind in the room. Then, “Sparkle, sparkle,” something that looked like flames of fire appeared over their heads. After this grand announcement, the Holy Spirit came quietly to live in the hearts of all the believers who gathered together that day.

5. The Holy Spirit might have come quietly, but He came powerfully, too! He gave the believers strength and courage and wisdom to do everything God wanted them to do. The believers had waited.

The Holy Spirit had come. Now, what it was time to do? Can you remember what Jesus told them? Now, it was time to GO! But go WHERE? To the whole world! And take WHAT special message? The good news of Jesus!



5. The Holy Spirit might have come quietly, but He came powerfully, too! He gave the believers strength and courage and wisdom to do everything God wanted them to do. The believers had waited. The Holy Spirit had come. Now, what it was time to do? Can you remember what Jesus told them? Now, it was time to GO! But go WHERE? To the whole world! And take WHAT special message? The good news of Jesus!

6. So, that's what they did, starting right there in Jerusalem.

“Jesus is God's Son, come to save sinners from the punishment they deserve from God,” Peter told a huge crowd in Jerusalem. “Turn away from disobeying God! Trust in Jesus as your Savior!” he urged them. “Be baptized as a sign that God has forgiven you and you are living a new life for Him.”

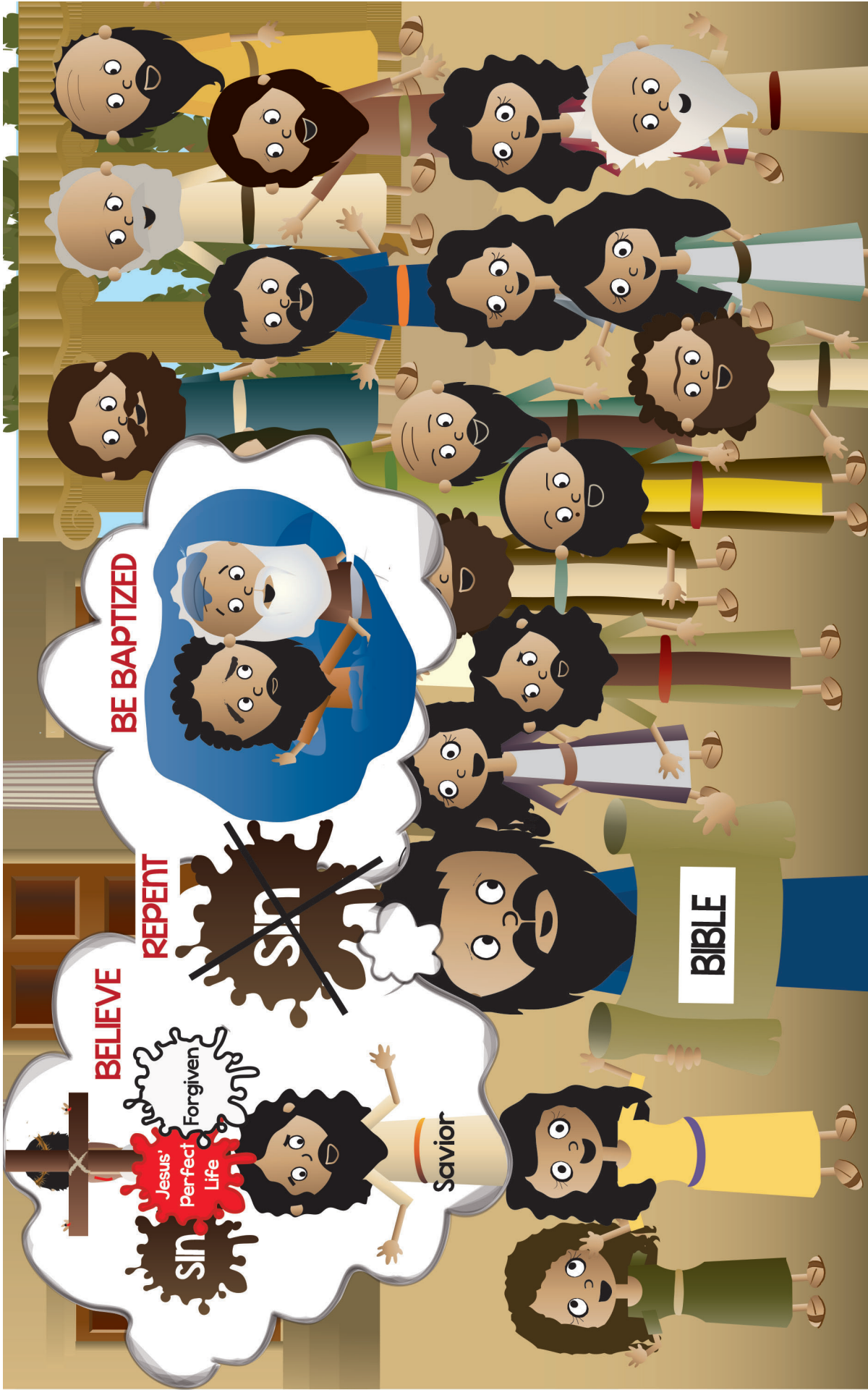

6. So, that's what they did, starting right there in Jerusalem. "Jesus is God's Son, come to save sinners from the punishment they deserve from God," Peter told a huge crowd in Jerusalem. "Turn away from disobeying God! Trust in Jesus as your Savior!" he urged them. "Be baptized as a sign that God has forgiven you and you are living a new life for Him."

7. The Holy Spirit helped Peter tell the good news of Jesus that day. The Holy Spirit worked in the hearts of the listeners, too. Many people heard and believed.

The Bible tells us about 3000 of them became God's people that one day! How wonderful!



7. The Holy Spirit helped Peter tell the good news of Jesus that day. The Holy Spirit worked in the hearts of the listeners, too. Many people heard and believed. The Bible tells us about 3000 of them became God's people that one day! How wonderful!

8. When someone becomes one of God's people, God works BIG changes in them. There's a change of heart on the INSIDE and a change of life on the OUTSIDE. They are like brand-new people.

Jesus gave God's people a special sign as a picture of this new beginning. Can you remember what it is? It's baptism. So, one by one, Peter led these new believers into the water to be baptized. "I baptize you in the name of God, the Father, Jesus, the Son of God, and God, the Holy Spirit," he told each person.



8. When someone becomes one of God's people, God works BIG changes in them. There's a change of heart on the **INSIDE** and a change of life on the **OUTSIDE**. They are like brand-new people. Jesus gave God's people a special sign as a picture of this new beginning. Can you remember what it is? It's baptism. So, one by one, Peter led these new believers into the water to be baptized. "I baptize you in the name of God, the Father, Jesus, the Son of God, and God, the Holy Spirit," he told each person.

9. Then, Peter carefully lowered each believer down into the water. Down they went, as a picture of their old life gone and their sins forgiven, taken away by Jesus when He died on the cross and was buried in a grave.



9. Then, Peter carefully lowered each believer down into the water. Down they went, as a picture of their old life gone and their sins forgiven, taken away by Jesus when He died on the cross and was buried in a grave.

10. Then a moment later, Peter lifted them back up out of the water. Up they came, as a picture of their new life for God begun. A new life given to them by Jesus, who rose from the dead. He had beaten sin and death for them. Now, they would get to live forever with God!

Day 3



10. Then a moment later, Peter lifted them back up out of the water. Up they came, as a picture of their new life for God begun. A new life given to them by Jesus, who rose from the dead. He had beaten sin and death for them. Now, they would get to live forever with God!

II. Baptism was a big step for these believers.

No, it didn't save them from their sins, or make them God's people. God saves all who turn away from their sins and trust in Jesus as their Savior, whether they are baptized or not.

But, baptism WAS a very BIG sign. It told everyone: "This person is a follower of Jesus now. Watch him! Watch her! They will show you what Jesus is like and how God wants us to live, loving Him and loving one another."



II. Baptism was a big step for these believers. No, it didn't save them from their sins, or make them God's people. God saves all who turn away from their sins and trust in Jesus as their Savior, whether they are baptized or not. But, baptism WAS a very BIG sign. It told everyone: "This person is a follower of Jesus now. Watch him! Watch her! They will show you what Jesus is like and how God wants us to live, loving Him and loving one another."

12. And others certainly did watch these new believers and all these baptisms.

Enemies watched and were angry. But many others watched, and when they saw the changed lives of these new believers, they wanted to hear about Jesus, too.



12. And others certainly did watch these new believers and all these baptisms. Enemies watched and were angry. But many others watched, and when they saw the changed lives of these new believers, they wanted to hear about Jesus, too.

13. Baptism was a sign of another very happy gift from God: the gift of a new family. God had made these new believers a part of His family, the Church.

Now, they were God's children, and all the other believers were their new, adopted brothers and sisters through Jesus. They gathered all together, listening to preaching from God's Word and learning how to live as God's people. They praised God and cared for each other's needs. Oh, how the Church in Jerusalem was growing and enjoying new life in Jesus!



13. Baptism was a sign of another very happy gift from God: the gift of a new family. God had made these new believers a part of His family, the Church. Now, they were God's children, and all the other believers were their new, adopted brothers and sisters through Jesus. They gathered all together, listening to preaching from God's Word and learning how to live as God's people. They praised God and cared for each other's needs. Oh, how the Church in Jerusalem was growing and enjoying new life in Jesus!

14. But Jerusalem was just the beginning of the “Go” Jesus had given them. Where else did Jesus tell them to go and make disciples? To the **WHOLE WORLD! So, away they went!**



14. But Jerusalem was just the beginning of the “Go” Jesus had given them. Where else did Jesus tell them to go and make disciples? To the **WHOLE WORLD!** So, away they went!

15. Philip went to the land of Samaria, just outside of Israel. The Holy Spirit helped him tell them the good news of Jesus:

“Jesus is God’s Son. Come to save sinners from the punishment they deserve from God,” Philip told the people of Samaria. “Turn away from disobeying God! Trust in Jesus as your Savior! Be baptized as a sign that God has forgiven you and you are living a new life for Him,” he urged them.



15. Philip went to the land of Samaria, just outside of Israel. The Holy Spirit helped him tell them the good news of Jesus: “Jesus is God’s Son. Come to save sinners from the punishment they deserve from God,” Philip told the people of Samaria. “Turn away from disobeying God! Trust in Jesus as your Savior! Be baptized as a sign that God has forgiven you and you are living a new life for Him,” he urged them.

16. The Holy Spirit helped Philip tell the good news of Jesus that day, and He worked in the hearts of the listeners, too. Many turned away from their sins, trusted in Jesus as their Savior, and were baptized.



16. The Holy Spirit helped Philip tell the good news of Jesus that day, and He worked in the hearts of the listeners, too. Many turned away from their sins, trusted in Jesus as their Savior, and were baptized.

17. Philip gathered them together into a new, little church of believers. They listened to Philip preach God's Word, and they learned how to live as God's people. They praised God together and cared for each other's needs.

Oh, how the Church in Samaria was growing and enjoying new life in Jesus!



17. Philip gathered them together into a new, little church of believers. They listened to Philip preach God's Word, and they learned how to live as God's people. They praised God together and cared for each other's needs. Oh, how the Church in Samaria was growing and enjoying new life in Jesus!

18. But Samaria wasn't the ends of the earth. It was only the land next door to Israel. There were many more people, in many other places, who needed to hear the good news of Jesus, too.

So, away went people like Paul and Barnabas, Timothy and Titus, over the mountains and across the sea, to tell more people.



18. But Samaria wasn't the ends of the earth. It was only the land next door to Israel. There were many more people, in many other places, who needed to hear the good news of Jesus, too. So, away went people like Paul and Barnabas, Timothy and Titus, over the mountains and across the sea, to tell more people.

19. “Jesus is God’s Son, come to save sinners from the punishment they deserve from God,” they told all who would listen. “Turn away from disobeying God! Trust in Jesus as your Savior! Be baptized as a sign that God has forgiven you and you are living a new life for Him,” they urged everyone.



19. “Jesus is God’s Son, come to save sinners from the punishment they deserve from God,” they told all who would listen. “Turn away from disobeying God! Trust in Jesus as your Savior! Be baptized as a sign that God has forgiven you and you are living a new life for Him,” they urged everyone.

20. The Holy Spirit helped these men tell the good news of Jesus, and He worked in the hearts of those listening. The Spirit gave them the gift of faith to hear and believe. They turned away from their sins, trusted in Jesus as their Savior, and THEN what did they do? They were baptized!



20. The Holy Spirit helped these men tell the good news of Jesus, and He worked in the hearts of those listening. The Spirit gave them the gift of faith to hear and believe. They turned away from their sins, trusted in Jesus as their Savior, and THEN what did they do? They were baptized!

21. Then, Paul and Barnabas, Timothy and Titus gathered together these new believers into little churches.

The believers listened to these pastors preach God's Word, and they learned how to live as God's people. They praised God together and cared for each other's needs.

Oh, how the Church in these faraway places was growing and enjoying new life in Jesus!



21. Then, Paul and Barnabas, Timothy and Titus gathered together these new believers into little churches. The believers listened to these pastors preach God's Word, and they learned how to live as God's people. They praised God together and cared for each other's needs. Oh, how the Church in these faraway places was growing and enjoying new life in Jesus!

22. Many years have passed since Jesus sent out those first Christians to share the gospel with the world. But sadly, there are still so many people, in so many places, who have never about Jesus.

And that's why Christians today are still obeying Jesus' command to go. That's why they are still telling people to turn away from disobeying God and to trust in Jesus as their Savior. And, they are still baptizing all who do, as a sign that they have been forgiven by God and are living a new life for Him.



22. Many years have passed since Jesus sent out those first Christians to share the gospel with the world. But sadly, there are still so many people, in so many places, who have never about Jesus. And that's why Christians today are still obeying Jesus' command to go. That's why they are still telling people to turn away from disobeying God and to trust in Jesus as their Savior. And, they are still baptizing all who do, as a sign that they have been forgiven by God and are living a new life for Him.

23. And Christians will keep on going, and telling, and baptizing new believers until the Church has finished growing and Jesus comes back.

Then, at last, all of God's people will be gathered all together, as one, big family, to live with God forever. What a wonderful day that will be!



23. And Christians will keep on going, and telling, and baptizing new believers until the Church has finished growing and Jesus comes back. Then, at last, all of God's people will be gathered all together, as one, big family, to live with God forever. What a wonderful day that will be!

DDD 15.5 Simple Story Scenes

“The Case of the Up and Down Sign” Matthew 28; Acts 1-2, 8:35-36, 10:47, 16:14-15, 31-34

SOLVED

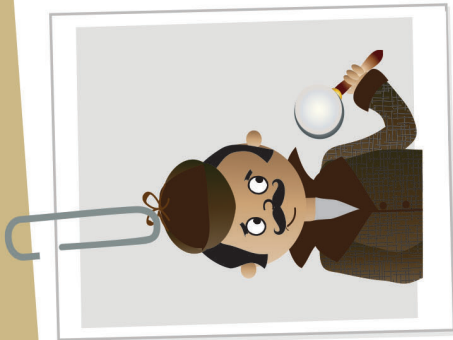

Detective Dan's Listening Assignment #1

1. What did Jesus tell new believers to do as a sign of their new life in God? To be baptized.
 2. Why did they go up and down in the water when they did this special sign? They went down in the water to remember that their sins had been buried down in the grave with Jesus. They went up, out of the water to remember that God had forgiven their sins and was giving them new life with Jesus who rose up from the dead. Jesus had beaten sin and death for them!
- For You and Me:
When we turn away from our sins and trust in Jesus as our Savior, a day will come when we, too, will be baptized. It will be a wonderful day of showing that we are turning from our old life of living for ourselves, and have begun a new life of living for God, by the help of His Holy Spirit.



Detective Dan's Listening Assignment #2

Acts 2:38, ESV

“Repent and be baptized every one of you in the name of Jesus Christ for the forgiveness of your sins.”

1. Who repented of their sins? How did their lives look different?
The new believers repented of their sins and trusted in Jesus as their Savior. The Holy Spirit lived inside of them. He helped them to love God and live for Him, instead of living their old way.
 2. What did they do as a sign that their lives had changed? They were baptized so the world could know they were choosing to live as followers of Jesus.
- For You and Me:
When we turn away from our sins and trust in Jesus as our Savior, a day will come when we, too, will be baptized. It will be a wonderful day of showing that we are turning from our old life of living for ourselves, and have begun a new life of living for God, by the help of His Holy Spirit.

DDD 15.5 Simple Story Scenes

Why Do God's People Go to Church?
To Worship God and Love One Another...
By Baptizing People Who Trust in and Live for Jesus!

The Gospel

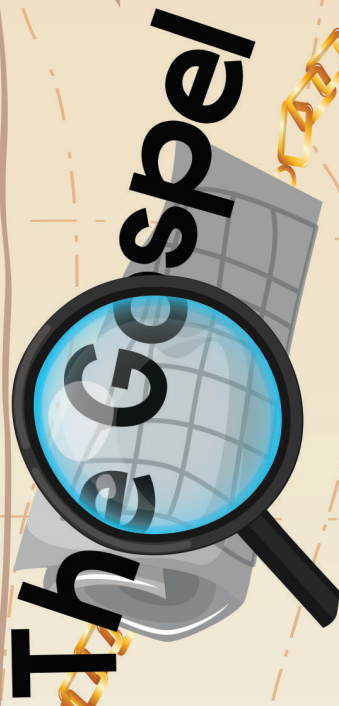

We all disobey God and deserve His punishment. But God, in His mercy, sent His Son, Jesus, to be our Savior. Jesus lived a perfect life, then on the cross, He gave it as the full payment for the sins of God's people. On the third day, Jesus rose from the grave. He had beaten sin and death for God's people!

Now, all who turn away from their sins and trust in Jesus as their Savior receive God's forgiveness. They are His people, and He fills their hearts with His Holy Spirit. They want to love Him and live for Him. We can become God's people, too, if we turn away from our sins and trust in Jesus as our Savior.

If we do, there will come a special day when we get to be baptized and share the story of how God worked in our lives and saved us. Ask God to help you do this!

He loves to answer this prayer.



DDD 15.5 Simple Story Scenes

A Prayer

A We praise You, God, for saving Your people, the Church, through Jesus. He is why we can become Your people.

C God, we know that we can never become Your people on our own. We have all turned away from You and Your good ways. We need a Savior!

T God, thank You for providing the way for us to become Your people through Jesus. Thank You for giving a new life to all who turn away from their sins and trust in Him. Thank You for giving us baptism to help us remember the new way of life You give to all who do this.

S God, work in our hearts. Help us to turn away from our sins and trust in Jesus as our Savior. Help us to one day be able to stand before God's people and tell the story of how You saved us. Help us to trust our leaders to know when we are ready to be baptized and when we need to still wait and grow.

In Jesus' name we pray, Amen.



DDD 15.5 Simple Story Scenes

DEEP DOWN DETECTIVES



Simple Story Scenes

Unit 15,

Bible Truth 6

Using Simple Story Scenes as a Curriculum

Introduce the Key Concept and Bible Verse

Simple Story Scenes give you the basics for the core of your lesson. You can use the overview sheet to introduce and explain the key concept and Bible verse.

Give the Case Assignment

Give the children a Detective Dan listening assignment. Two are provided. You can add a third using the ideas on the bonus, third take-home sheet, if desired. Each listening assignment, let's you teach the story with a different learning emphasis.

Show & Tell the Story

Hold up the pictures and tell the story from the story scenes. Alternatively, you can find in the and Pieces section for this unit at praisefactory.org, these same listening assignments and story scenes, gospel and ACTS prayer modified for view on a screen. Simply download them or open them online and show through your own monitor (tablet, big screen, whatever).

Solve the Case

Repeat Detective Dan's listening assignment question and discuss the answer.

Share the Gospel

Share the gospel tie-in with the kids.

Close in ACTS Prayer

Pray the ACTS prayer with the kids. If using the curriculum with older children, give them a chance to think up their own ACTS tie-ins to the story, using the one provided as cues/ideas for you.

Review Time

Give out the take-home sheet (there are three: two that correlates to the two Detective Dan assignments in the Story Scenes, and a bonus third one.) As the children are coloring, use the take-home sheet discussion questions or your own questions to further review and apply the key concepts, Bible verse, and story truths to the children.

Looking for more?

Online, in the Bits and Pieces section for this unit, you will find review games, crafts, storyboard flannelgraph figures, and audio and sheet music for all of the songs. There are also full lesson plans that offer more of a script and take this curriculum's possibilities to much more depth. Don't forget to tell the parents about the Parents Resources section where they can read through the Story scenes and download take homes with their kids.

Unit 15: God's People Gather Together**Unit Big Question (and Answer):** Why Do God's People Go to Church?

To Worship God and Love One Another!

Unit Bible Verse: "And let us consider how to stir up one another to love and good works, not neglecting to meet together." Hebrews 10:24-25, ESV**Bible Truth 6 Concept: To Worship God and Love One Another... By Remembering Jesus Died to Save Them!**

When God's people gather together, they remember how Jesus died to save them. They do this with a special meal called "the Lord's Supper." It's called this because Jesus shared it with His own special followers on the night before He died on the cross.

There are only two, little pieces of food eaten at the Lord's Supper: a little piece of bread and a little grape juice or wine. That's because it's not really about eating a whole, big meal. It's about remembering what Jesus did for God's people when He died on the cross.

The bread stands for Jesus' body, that He offered up for the sins of God's people. He took in His body, the punishment they deserved from God for their sins. He did this so they would never have to know that punishment themselves.

The grape juice or wine stands for Jesus' blood shed when He died on the cross. Blood was a part of every big, covenant promise. It reminded everyone that this promise must be kept, no matter what. Jesus said the juice/wine was to remind God's people of His blood given to make a new covenant/forever promise with God. It meant that no matter what, His payment for their sins was enough. They would always be forgiven. They would always be God's people, having special closeness with Him now. And one day, living with Him forever.

When God's people take the Lord's Supper, it is a very special time. People are usually very quiet. Many think about the ways they have disobeyed God and ask for His forgiveness. Many thank God for sending Jesus to save them. Jesus told God's people that they were to keep on celebrating this special meal until He comes back at the end of time. Only God's people who repent of their sins, trust in Jesus as their Savior, and are baptized should take the Lord's Supper. We can become God's people, too, when we repent of our sins and trust in Jesus as our Savior.

Bible Truth 6 Bible Verse: Luke 22:19,20, ESV

"This is my body, which is given for you. Do this in remembrance of me." And likewise the cup after they had eaten, saying, "This cup that is poured out for you is the new covenant in my blood."

Learn a Little: "This is my body, which is given for you. Do this in remembrance of me."**Meaning**

When God's people gather together at church, they remember how Jesus died on the cross to save them. They remember that He let His body be hurt and His blood be spilled out as He suffered and died for their sins. How do they do this? The way Jesus told His disciples to: with a special little meal of bread and wine or grape juice. The bread is eaten as a way to remember how His body was broken on the cross for their sins. The wine or grape juice is drunk as a way to remember that it was His blood that paid for their sins so they could be forgiven by God. God's people have this special meal often, just like Jesus told them to. How thankful they are for Jesus and all He did for them!

We can become God's people when we turn away from our sins and trust in Jesus as our Savior.

Bible Truth 6 ACTS Prayer

- A** We praise You, God, for being the Savior of Your people, the Church.
- C** God, this special meal reminds us of what Jesus did to save sinners like us. We know that we have all chosen to live life our own way. We have all chosen not to love You or obey Your good ways. We need a Savior! You are our only hope.
- T** God, thank You for sending Jesus to be our Savior. Thank You for His body, given to pay for the sins of all who trust in Him as their Savior. Thank You for His blood, given as the promise that those who turn away from their sins and trust in Jesus are Your people forever.
- S** God, work in our hearts. Help us to turn away from our sins and trust in Jesus as our Savior. Make us Your people. Use this special meal to remind us of what Jesus has done.

In Jesus' name we pray, Amen.

Bible Truth 6 Story

The Case of the Remembered Rescue *Exodus 12; Luke 22; Isaiah 25:6-9*

Songs Used in Bible Truth 6

Big Q & A 15 Song

Big Question 15 Song: Why Do God's People Go to Church?

Big Question 15 Bible Verse Song: Stir Up Hebrews 10:24-25, ESV

Big Question 15 Hymn: Brethren, We Have Met to Worship, v.1

Big Question 15 Praise Song: Praise the Lord Together

Bible Truth 6 Bible Verse: This Is My Body Luke 22:19,20, ESV

Bible Truth 6 Extra Bible Verse: He Took Bread Luke 22:19,20, HCSB

listen to or download songs for free at <https://praisefactory.org>: Deep Down Detectives Music page

“The Case of the Remembered Rescue” Exodus 12; Luke 22; Isaiah 25:6-9



Detective Dan's Listening Assignment #1

1. What rescue did Jesus and his disciples remember on the night before Jesus died?
2. What even bigger rescue did Jesus give them to remember from that night on?



Detective Dan's Listening Assignment #2

Luke 22:19,20, ESV

“This is my body, which is given for you. Do this in remembrance of me.” And likewise the cup after they had eaten, saying, “This cup that is poured out for you is the new covenant in my blood.”

1. Who gave His body and blood to save God's people from their sins?
2. What special meal do God's people eat to remember what He did?

(more listening and discussion questions are included in the curriculum at praisefactory.org)

I. Every year, the people of Israel gathered together to remember how God rescued them from their strong enemies, the Egyptians.



I. Every year, the people of Israel gathered together to remember how God rescued them from their strong enemies, the Egyptians.

2. The Egyptians had made the people of Israel their slaves. They were so mean to them!

They made the people of Israel work terribly hard and didn't pay them. They hurt them when they didn't work hard enough, and they planned to never let them go.

The people of Israel cried out to God, "Help us, help us! Save us from these strong enemies!" Would the LORD hear them? Would He help them?



2. The Egyptians had made the people of Israel their slaves. They were so mean to them! They made the people of Israel work terribly hard and didn't pay them. They hurt them when they didn't work hard enough, and they planned to never let them go. The people of Israel cried out to God, "Help us, help us! Save us from these strong enemies!" Would the LORD hear them? Would He help them?

3. Yes, He would! The LORD heard them, and He sent Moses to help them.

Through Moses, the LORD did many amazing things to show the Egyptians that He was the one, true God. The LORD would make the Egyptians free the people of Israel.



3. Yes, He would! The LORD heard them, and He sent Moses to help them. Through Moses, the LORD did many amazing things to show the Egyptians that He was the one, true God. The LORD would make the Egyptians free the people of Israel.

4. The day before the people of Israel were to be freed, the LORD gave them special instructions through Moses: “I’m going to send a terrible punishment into Egypt tonight,” says the LORD. “After this terrible punishment, the Egyptians will free you.”



4. The day before the people of Israel were to be freed, the LORD gave them special instructions through Moses: "I'm going to send a terrible punishment into Egypt tonight," says the LORD. "After this terrible punishment, the Egyptians will free you."

5. “But there is something you must do, if the terrible punishment is not to come upon you, too,” the LORD told them. “Each family must take the blood of a lamb and put it along the top and sides of the door to your home,” the LORD said.

“If you do this, I promise the terrible punishment will pass over you and you will be saved. Only your enemies, the Egyptians, will be punished,” the LORD told them through Moses.



5. "But there is something you must do, if the terrible punishment is not to come upon you, too," the LORD told them. "Each family must take the blood of a lamb and put it along the top and sides of the door to your home," the LORD said. "If you do this, I promise the terrible punishment will pass over you and you will be saved. Only your enemies, the Egyptians, will be punished," the LORD told them through Moses.

6. “After the terrible punishment comes to the Egyptians, it will be time for you to go,” the LORD said. “Hurry, get everything ready now. You’ll be leaving early in the morning. Don’t even wait for your bread to get puffy and rise. There’s no time. Bake it and eat it flat, so you’ll be ready to go,” they were told.

“Tonight, is your last night in Egypt,” the LORD said. “Celebrate! Eat the lamb whose blood you put on your doors and eat the flat bread at dinner tonight. Do this to remember what I’m doing for you.”

HURRY!

HURRY!



6. "After the terrible punishment comes to the Egyptians, it will be time for you to go," the LORD said. "Hurry, get everything ready now. You'll be leaving early in the morning. Don't even wait for your bread to get puffy and rise. There's no time. Bake it and eat it flat, so you'll be ready to go," they were told. "Tonight, is your last night in Egypt," the LORD said. "Celebrate! Eat the lamb whose blood you put on your doors and eat the flat bread at dinner tonight. Do this to remember what I'm doing for you."

7. Their last night in Egypt!? Could this really be true? The king of Egypt had promised to let them go before, but changed his mind every time. Would the king really let them go now? Would the people of Israel believe the LORD's promise and obey Him?



7. Their last night in Egypt!? Could this really be true? The king of Egypt had promised to let them go before, but changed his mind every time. Would the king really let them go now? Would the people of Israel believe the LORD's promise and obey Him?

8. Yes, they would!

The people of Israel did everything the LORD told them to do. They put lamb's blood on the tops and sides of their doors. They packed up their things. They didn't wait for their bread to get puffy, like they usually did, but baked it flat. And that night, they ate the lamb and the flat bread to remember what the LORD was doing for them.



8. Yes, they would! The people of Israel did everything the LORD told them to do. They put lamb's blood on the tops and sides of their doors. They packed up their things. They didn't wait for their bread to get puffy, like they usually did, but baked it flat. And that night, they ate the lamb and the flat bread to remember what the LORD was doing for them.

9. Late that night, the terrible punishment came, just as the LORD said. It came upon every single Egyptian family, because there was no lamb's blood around their doors.

But the punishment passed over the people of Israel. The LORD had kept His promise and spared them this punishment, thanks to the blood of the lamb.



9. Late that night, the terrible punishment came, just as the LORD said. It came upon every single Egyptian family, because there was no lamb's blood around their doors. But the punishment passed over the people of Israel. The LORD had kept His promise and spared them this punishment, thanks to the blood of the lamb.

10. “Boo Hoo! Boo Hoo!” cried the Egyptians. “How terrible is the LORD’s punishment on us! We don’t want the people of Israel to stay here and work for us anymore! Go away, people of Israel! Leave our country!” they exclaimed.



10. "Boo Hoo! Boo Hoo!" cried the Egyptians. "How terrible is the LORD's punishment on us! We don't want the people of Israel to stay here and work for us anymore! Go away, people of Israel! Leave our country!" they exclaimed.

II. “Yay! Yay!” shouted the people of Israel. “Praise the LORD! He has freed us!”

They gathered up their belongings and walked out of Egypt. They were so glad to be leaving their enemies! What a great day this was for the people of Israel. The LORD had rescued them with such powerful signs and wonders.



II. "Yay! Yay!" shouted the people of Israel. "Praise the LORD! He has freed us!" They gathered up their belongings and walked out of Egypt. They were so glad to be leaving their enemies! What a great day this was for the people of Israel. The LORD had rescued them with such powerful signs and wonders.

12. “Remember this Passover night! Remember this day when I rescued you and freed you from your enemies! “Once a year, I want you to eat a special meal to remember,” the LORD told the people of Israel through Moses.



12. "Remember this Passover night! Remember this day when I rescued you and freed you from your enemies! "Once a year, I want you to eat a special meal to remember," the LORD told the people of Israel through Moses.

13. “Drink red wine (juice of grapes) and remember how My punishment passed over you. I kept the promise I made to you through the lamb’s blood,” the LORD said. “Eat flat bread and remember how quickly you had to leave when I freed you from the Egyptians.

Celebrate the Passover every year, so you won’t forget the great things I did to save you from your enemies,” the LORD told them.



13. "Drink red wine (juice of grapes) and remember how My punishment passed over you. I kept the promise I made to you through the lamb's blood," the LORD said. "Eat flat bread and remember how quickly you had to leave when I freed you from the Egyptians. Celebrate the Passover every year, so you won't forget the great things I did to save you from your enemies," the LORD told them.

14. So, for hundreds of years, all the way down to Jesus' day, the people of Israel kept on remembering the Passover with the special, red wine (juice from grapes) and the very flat bread.

They had so much to celebrate! After all, what greater enemy than the Egyptians would they ever face? And, what greater punishment would they need to be rescued from than the terrible punishment the Egyptians received that Passover night?



14. So, for hundreds of years, all the way down to Jesus' day, the people of Israel kept on remembering the Passover with the special, red wine (juice from grapes) and the very flat bread. They had so much to celebrate! After all, what greater enemy than the Egyptians would they ever face? And, what greater punishment would they need to be rescued from than the terrible punishment the Egyptians received that Passover night?

15. Well, the truth is, there WAS a greater enemy, and a bigger punishment they needed to be rescued from. The enemy was sin. And the punishment was death –being separated from God and all His goodness forever.

And this enemy and this punishment weren't just trouble for the people of Egypt or the people of Israel. These were trouble for the whole world. For you see, we all are sinners who have disobeyed God and we all deserve the LORD's punishment for our sins.



15. Well, the truth is, there WAS a greater enemy, and a bigger punishment they needed to be rescued from. The enemy was sin. And the punishment was death -being separated from God and all His goodness forever. And this enemy and this punishment weren't just trouble for the people of Egypt or the people of Israel. These were trouble for the whole world. For you see, we all are sinners who have disobeyed God and we all deserve the LORD's punishment for our sins.

16. Yes, the sin in our hearts is a far stronger enemy than those Egyptians ever were!

But who could rescue people from this kind of enemy? Who could save us from God's punishment? Would the blood of an ordinary lamb be enough, like it was for the Passover?

No, the blood of that kind of lamb would never be enough! But there WAS blood that WAS enough. The blood of God's perfect Son. Do you know His name? It's Jesus!



16. Yes, the sin in our hearts is a far stronger enemy than those Egyptians ever were! But who could rescue people from this kind of enemy? Who could save us from God's punishment? Would the blood of an ordinary lamb be enough, like it was for the Passover? No, the blood of that kind of lamb would never be enough! But there **WAS** blood that **WAS** enough. The blood of God's perfect Son. Do you know His name? It's Jesus!

17. John the Baptist gave Jesus a special nickname: the Lamb of God. John knew Jesus had come to save God's people.

Jesus would live a perfect life, then give it as the full payment for the sins of God's people. Jesus would take away their sins by taking their punishment. Oh, how God loves His people, that He would give His only Son do to this!



17. John the Baptist gave Jesus a special nickname: the Lamb of God. John knew Jesus had come to save God's people. Jesus would live a perfect life, then give it as the full payment for the sins of God's people. Jesus would take away their sins by taking their punishment. Oh, how God loves His people, that He would give His only Son do to this!

18. Jesus told His disciples He would die for God's people, but they didn't understand.

At last, came the night when Jesus would be led away to die. It was the Passover, so He and His disciples gathered together to eat the special meal and remember how God rescued the people of Israel from the Egyptians.

Only this time, Jesus used the wine and the flat bread to tell about the even GREATER rescue God was about to do for ALL of God's people.



18. Jesus told His disciples He would die for God's people, but they didn't understand. At last, came the night when Jesus would be led away to die. It was the Passover, so He and His disciples gathered together to eat the special meal and remember how God rescued the people of Israel from the Egyptians. Only this time, Jesus used the wine and the flat bread to tell about the even GREATER rescue God was about to do for ALL of God's people.

19. Jesus took the flat bread, and said, “This Passover flat bread helped you remember God’s rescue of Israel long ago. Now, eat it to remember something new,” Jesus told His disciples. “This is My body broken for you.”

“Tomorrow, I will give My body as the perfect sacrifice for you and all of God’s people when I suffer and die on the cross. Take it and eat it; and, remember Me when you do!”



19. Jesus took the flat bread, and said, "This Passover flat bread helped you remember God's rescue of Israel long ago. Now, eat it to remember something new," Jesus told His disciples. "This is My body broken for you. Tomorrow, I will give My body as the perfect sacrifice for you and all of God's people when I suffer and die on the cross. Take it and eat it; and, remember Me when you do!"

20. Then, Jesus picked up the cup of red wine, and said, “This Passover wine helped you remember the lamb’s blood God used, so His punishment would pass over Israel. Now, drink it to remember something new,” Jesus told them. “This is My blood poured out for you.”

“Tomorrow, I will pay for the sins of God’s people with My blood when I die on the cross,” Jesus said. “Take it and drink it; and, remember me when you do.”



20. Then, Jesus picked up the cup of red wine, and said, "This Passover wine helped you remember the lamb's blood God used, so His punishment would pass over Israel. Now, drink it to remember something new," Jesus told them. "This is My blood poured out for you. Tomorrow, I will pay for the sins of God's people with My blood when I die on the cross," Jesus said. "Take it and drink it; and, remember Me when you do."

21. “Because of Me, God is making a new, big covenant promise with His people. They will be forgiven their sins forever.”

“And on the Last Day, when God gives out His punishment for sins, He will pass over His people --all those who have turned away from disobeying God and have trusted in Me as their Savior. They won't be punished because I will have already taken God's punishment for them on the cross,” Jesus explained.



21. "Because of Me, God is making a new, big covenant promise with His people. They will be forgiven their sins forever. And on the Last Day, when God gives out His punishment for sins, He will pass over His people --all those who have turned away from disobeying God and have trusted in Me as their Savior. They won't be punished because I will have already taken God's punishment for them on the cross," Jesus explained.

22. “After I’m gone, eat this little meal when you gather together with God’s people. Use it to remember what I’ve done for you. Keep on eating it regularly until the day I come back as King, and put an end to sin and death forever,” Jesus told them.

The disciples were sad and surprised by Jesus’ words. Would He really die as He said He would?



22. "After I'm gone, eat this little meal when you gather together with God's people. Use it to remember what I've done for you. Keep on eating it regularly until the day I come back as King, and put an end to sin and death forever." Jesus told them. The disciples were sad and surprised by Jesus' words. Would He really die as He said He would?

23. Yes, He would!

Later that night, soldiers came and took Jesus away. The next day, Jesus was nailed to a cross; and there, He suffered and died for the sins of God's people, just as He said He would.



23. Yes, He would! Later that night, soldiers came and took Jesus away. The next day, Jesus was nailed to a cross; and there, He suffered and died for the sins of God's people, just as He said He would.

24. Jesus was buried in a cave-grave by friends, but He wouldn't stay there!

On Day One, Two, Three, Jesus rose from the dead. Jesus had really paid for the sins of God's people. He had beaten sin and death for them!

Day 3



24. Jesus was buried in a cave-grave by friends, but He wouldn't stay there! On Day One, Two, Three, Jesus rose from the dead. Jesus had really paid for the sins of God's people. He had beaten sin and death for them!

25. Jesus' disciples were so happy! They spread the wonderful news to everyone: "Come, repent and believe in Jesus. Because of Him, your sins can be forgiven, and you can become God's people," they exclaimed.

And as they told the good news of Jesus, many people turned away from their sins and trusted in Jesus as their Savior. God was growing His Church!

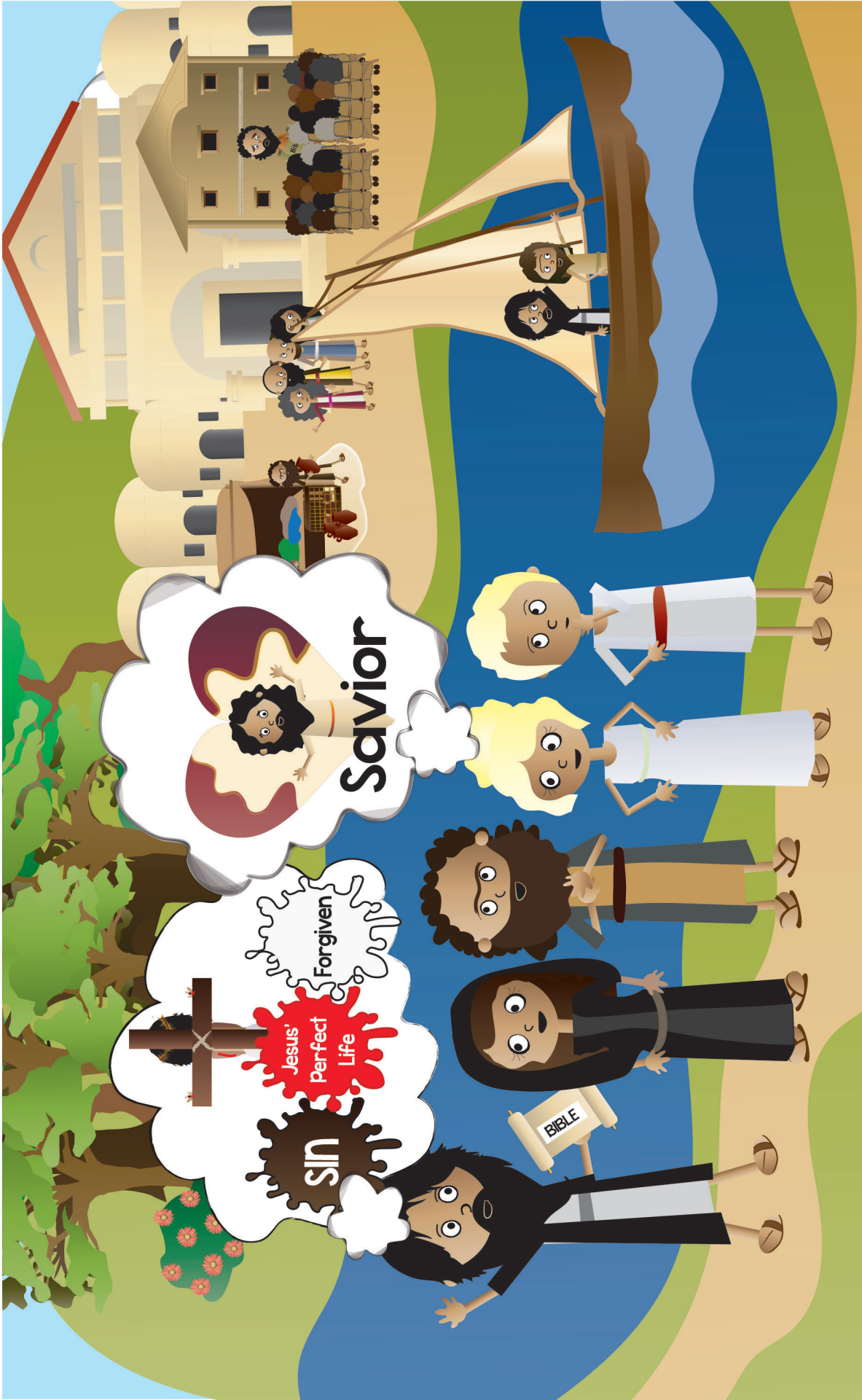

25. Jesus' disciples were so happy! They spread the wonderful news to everyone: "Come, repent and believe in Jesus. Because of Him, your sins can be forgiven, and you can become God's people," they exclaimed. And as they told the good news of Jesus, many people turned away from their sins and trusted in Jesus as their Savior. God was growing His Church!

26. The believers gathered together to worship God and love one another. And when they gathered, they ate the special meal of flat bread and red wine. They called it “the Lord’s Supper”; and through it, they remembered how Jesus gave His life that God’s punishment would pass over them.



26. The believers gathered together to worship God and love one another. And when they gathered, they ate the special meal of flat bread and red wine. They called it “the Lord’s Supper”; and through it, they remembered how Jesus gave His life that God’s punishment would pass over them.

27. Even today, God's people still gather together to worship God and love one another. And they STILL take the Lord's Supper together. They eat the flat bread and drink the red wine (or grape juice) and remember what Jesus did for them when He suffered and died on the cross.

And they will keep on eating and drinking this special meal until Jesus comes back when His plans for this world are finished.



27. Even today, God's people still gather together to worship God and love one another. And they STILL take the Lord's Supper together. They eat the flat bread and drink the red wine (or grape juice) and remember what Jesus did for them when He suffered and died on the cross. And they will keep on eating and drinking this special meal until Jesus comes back when His plans for this world are finished.

28. Then, at last, this meal will never be eaten again. Instead, God's people will have a NEW meal, called the Wedding Feast of the Lamb.

The food will be the best food anyone has ever tasted! The drink will be rich and delicious, too. And it will be the biggest and best party EVER, to celebrate the best day EVER: the day when God's people will be joined with Jesus, all together, face-to-face, forever!



Wedding Feast of the Lamb

28. Then, at last, this meal will never be eaten again. Instead, God's people will have a **NEW** meal, called the **Wedding Feast of the Lamb**. The food will be the best food anyone has ever tasted! The drink will be rich and delicious, too. And it will be the biggest and best party **EVER**, to celebrate the best day **EVER**: the day when God's people will be joined with Jesus, all together, face-to-face, forever!

29. Sin, sadness, and death will be gone. And God's people will go on enjoying the perfect Wonderfulness of God forever. Forever happy. Forever together. Forever praising God.



29. Sin, sadness, and death will be gone. And God's people will go on enjoying the Perfect Wonderfulness of God forever. Forever happy. Forever together. Forever praising God.

DDD 15.6 Simple Story Scenes

“The Case of the Remembered Rescue” Exodus 12; Luke 22; Isaiah 25:6-9

SOLVED

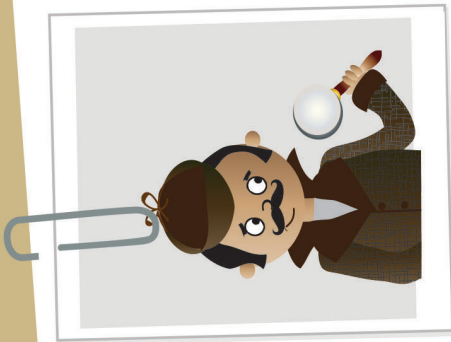

Detective Dan's Listening Assignment #1

1. What rescue did Jesus and his disciples remember on the night before Jesus died?
How God rescued the people of Israel from being slaves in Egypt.

2. What even bigger rescue did Jesus give them to remember from that night on?
How He would rescue God's people from their sins when He suffered and died on the cross in their place.

For You and Me:
Even today God's people continue to remember how Jesus saved them from their sins when He died on the cross for them. Even today, they still eat the special little meal He first ate with His disciples on the night before He died. If we turn away from our sins and trust in Jesus is our Savior, then one day we will also get to share in this special meal and remember what Jesus did for us on the cross. Ask God to help you do this. He loves to answer this prayer!



Detective Dan's Listening Assignment #2

Luke 22:19,20, ESV

“This is my body, which is given for you. Do this in remembrance of me.” And likewise the cup after they had eaten, saying, “This cup that is poured out for you is the new covenant in my blood.”

1. Who gave His body and blood to save God's people from their sins? Jesus did, when He suffered and died on the cross.

2. What special meal do God's people eat to remember what He did? The Lord's Supper --a little meal of bread and grape juice/wine.

For You and Me:

Even today God's people continue to remember how Jesus saved them from their sins when He died on the cross for them. Even today, they still eat the special little meal He first ate with His disciples on the night before He died. If we turn away from our sins and trust in Jesus is our Savior, then one day we will also get to share in this special meal and remember what Jesus did for us on the cross. Ask God to help you do this. He loves to answer this prayer!

DDD 15.6 Simple Story Scenes

Why Do God's People Go to Church?
To Worship God and Love One Another...
By Remembering Jesus Died to Save Them!

The Gospel



We have all disobeyed God and deserve His punishment. But God is so merciful that He sent His Son, Jesus, to be our Savior. Jesus lived a perfect life and gave it as the full payment for the sins of God's people when He died on the cross. Then, on the third day, Jesus rose from the dead. He had really beaten sin and death for God's people. Now, all who turn away from their sins and trust in Jesus as their Savior are forgiven their sins and become God's people.

We can become God's people, too, when we turn away from our sins and trust in Jesus as our Savior. And if you do, then one day, you, too will get to join God's people in this special meal, remembering how Jesus died to save you.



DDD 15.6 Simple Story Scenes

A Prayer

A God, we praise You for being the Savior of Your people, the Church.

C God, this special meal reminds us of what Jesus did to save sinners like us. We know that we have all chosen to live life our own way. We have all chosen not to love You or obey Your good ways. We need a Savior! You are our only hope.

T God, thank You for sending Jesus to be our Savior. Thank You for His body, given to pay for the sins of all who trust in Him as their Savior. Thank You for His blood, given as the promise that those who turn away from their sins and trust in Jesus are Your people forever.

S God, work in our hearts. Help us to turn away from our sins and trust in Jesus as our Savior. Make us Your people. Use this special meal to remind us of what Jesus has done.

In Jesus' name we pray, Amen.



DDD 15.6 Simple Story Scenes

DEEP DOWN DETECTIVES



Take-Home Sheets

CAN YOU GUESS BIBLE TRUTH I:
Why Do God's People Go to Church?
To Worship God and Love
One Another...

By Praising God for Jesus'
Win over

----- !

HINT: "What is the opposite of alive?"
It starts with a "D" and it rhymes
with "breath."

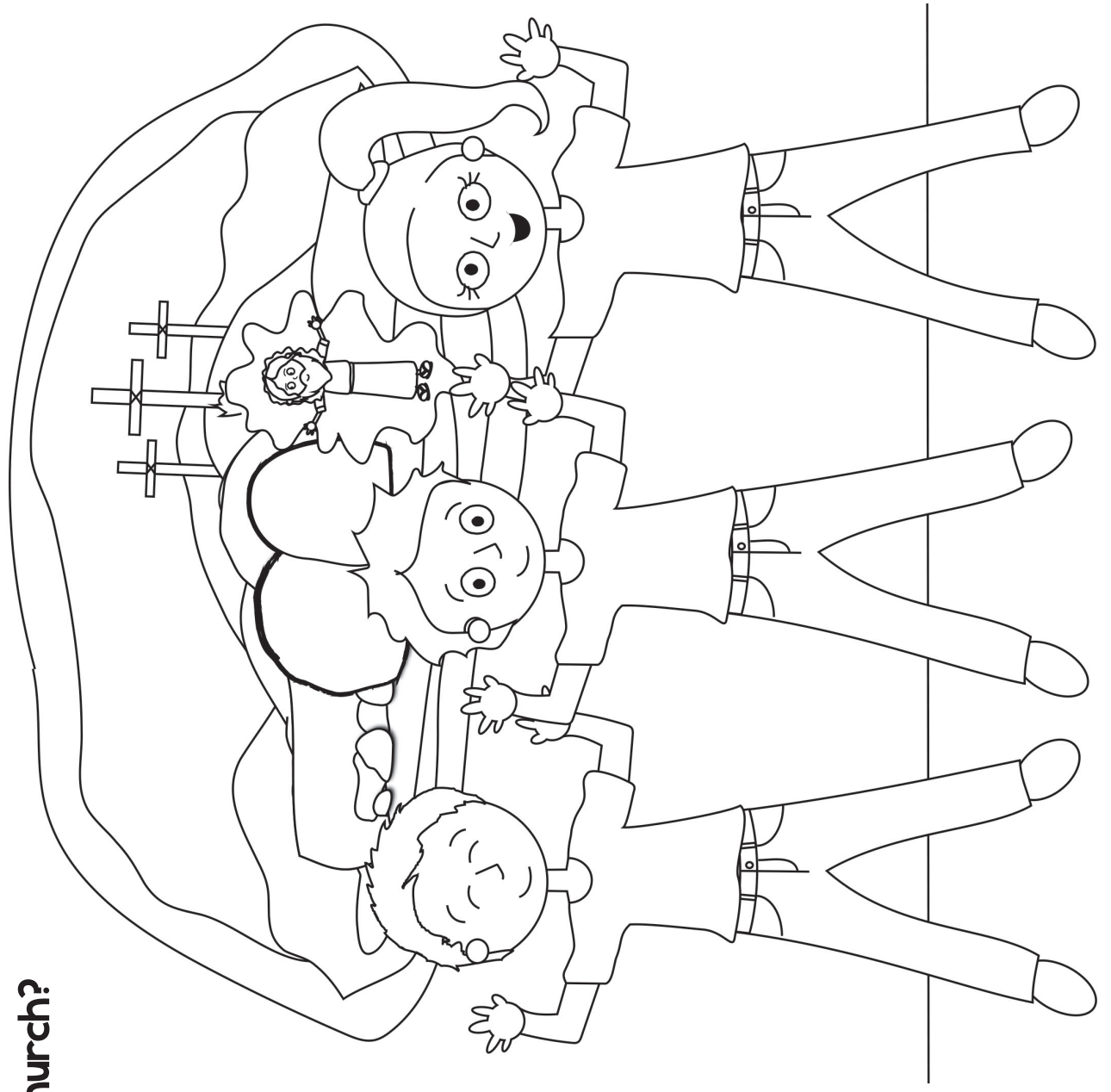

Deep Down Detective Devotion: Unit 15, Bible Truth 1, Lesson 1



Big Question 15: Why Do God's People Go to Church?

Answer: To Worship God and Love One Another... By Praising God for Jesus' Win over Death!

Bible Truth 1 Meaning

On one sad Friday, Jesus suffered and died on the cross for God's people. He was buried in a grave, but He didn't stay there. He rose up from the grave on Day Three—Sunday! He was alive and would be forevermore! Ever since that first and best Sunday when Jesus beat sin and death, God's people have been gathering together each week to celebrate. (The big, Bible word for God's people gathered together is "congregation.") They sing and pray and listen to God's Word. They rejoice that Jesus had beaten sin and death for them. They are happy the Holy Spirit lives in their hearts. They look forward to the day when Jesus will come back and all of God's people will at last gather together forever as one, big family. That will be the biggest and best celebration of all! Now all who turn away from their sins and trust in Jesus as their Savior receive God's forgiveness for their sins. He sends His Holy Spirit to live in their hearts and helps them love God and live for Him the rest of their lives. Forever they will be God's dearly-loved people! What an amazing gift God has given us through Jesus! God's people love to celebrate together, but they are always hoping for more to join them. That's why they tell their neighbors nearby the good news of Jesus. (The big, Bible word for telling others about Jesus is "evangelism.") And that's why they even travel to faraway lands to tell people there about Jesus, too. (The big, Bible word for going to another land to tell people about Jesus is "missions.") They want everyone to hear the good news of Jesus, repent of their sins and trust in Jesus as their Savior. (The big, Bible word for the good news of Jesus is "the gospel.") They want them all to become God's people and join the Sunday celebration of what God has done through Jesus! We can be God's people, too, when we turn away from our sins and trust in Jesus as our Savior. Sundays will be our celebration day, too!

How do I know this is true? The Bible tells me so!

"He has given us a new birth into a living hope through the resurrection of Jesus Christ from the dead." --1 Peter 1:3, HCSB

Some Questions for You

1. On what day of the week did Jesus rise from the dead? *Sunday.*
2. Why do God's people meet together on Sundays? *That's the day Jesus rose from the dead.*
3. What did Jesus show when He rose from the dead? *That He really had beaten death when He died on the cross.*
4. Thinking about what makes God's people very happy? *Thinking about how Jesus took away their punishment once and for all.*
5. To whom do God's people tell the good news of Jesus? Why? *To their nearby neighbors and people who live in faraway lands. They hope they will all become God's people and gather with them, too!*
6. How can we become God's people? *By turning away from our sins and trusting in Jesus as our Savior.*

Let's Pray!

- A** We praise You, God, for saving Your people, the Church. We praise You for being so powerful that You beat sin and death for them.
- C** God, we know that Sunday should be a special celebration day. It's the day Jesus rose from the dead. But sometimes, we would rather not go to church and celebrate. We would rather do something else that seems more fun. We don't treasure what Jesus did on the cross. We need a Savior!
- T** God, thank You for beating sin and death for God's people through Jesus. Thank You that they don't have to face Your punishment for sin. They get to know You in their hearts now, and get to live with You in heaven when they die. Thank You that we can be Your people, too, when we turn away from our sins and trust in Jesus as our Savior.
- S** God, work in our hearts. Help us to turn away from our sins and trust in Jesus as our Savior. Help us to celebrate Jesus' win over sin and death as we gather together with God's people at church. In Jesus' name we pray, Amen.

Let's Sing about What We're Learning!

Go to the Deep Down Detectives Parent Resources for Unit 15 to get the Bible story and many more resources and songs for this unit at praisefactory.org

Big Q & A 15 Song from *Deep Down Detectives ESV Songs 15, track 12* (sung to the tune of "This Is the Way We Wash Our Clothes")

Why do God's people go to church?
Go to church? Go to church?
Why do God's people go to church?
To worship God and to love one another!

Big Question 15 Action Rhyme Song from *Deep Down Detectives ESV Songs 15, track 13*

Refrain:

Why do God's people go to church?
To worship God and love one another.
Why do God's people go to church?
To worship God and love one another.

Verse 1:

A church is God's people,
Gathered together.
It's not a building of bricks.
It's made up of people,
Who follow Jesus,
In faith and repentance. *Refrain*

Verse 2

God's people gather to worship God.
To sing His praises and pray.
They listen to preaching,
From God's Word, the Bible,
To better love Him each day.
Refrain

Verse 3

God's people gather to love one another,
In acts of kindness and grace.
They love one another,
Like sisters and brothers,
Helping all to live God's way.
Refrain

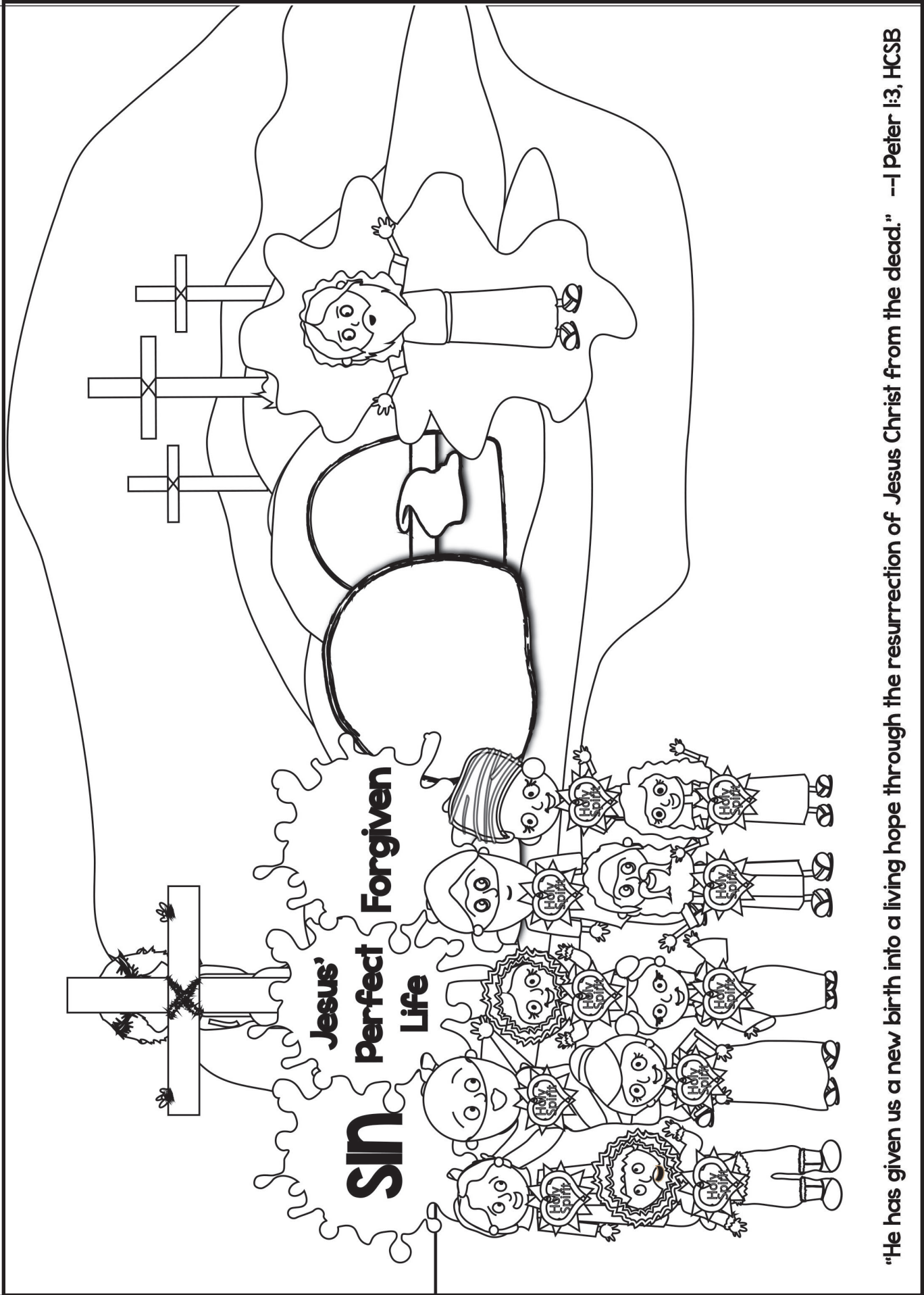

“He has given us a new birth into a living hope through the resurrection of Jesus Christ from the dead.” --1 Peter 1:3, HCSB

Deep Down Detective Devotion: Unit 15, Bible Truth 1, Lesson 2



Big Question 15: Why Do God's People Go to Church?

Answer: To Worship God and Love One Another... By Praising God for Jesus' Win over Death!

How do I know this is true? The Bible tells me so!

"He has given us a new birth into a living hope through the resurrection of Jesus Christ from the dead." --1 Peter 1:3, HCSB

Learn a Little: He has given us a new birth through the resurrection of Jesus Christ from the dead."

Meaning

When we are born as babies, we have our first birth. But did you know that all who turn away from their sins and trust in Jesus as their Savior are given a new birth? Not a new birth as a baby again. This isn't a new birth for our bodies. God gives our heart a new birth. He forgives all our sins and gives us a new heart filled with the Holy Spirit --a heart that knows God, and wants to love Him and live for Him. Jesus is why God's people get to have this wonderful new birth. He died on the cross for their sins. He made the way for them to be God's people. But Jesus didn't stay dead. He was resurrected. (That's a big Bible word meaning that He rose from the dead.) Yes, on that third day--that glorious Easter Sunday morning-- He rose from the dead, showing that He had really beaten sin and death for them. Jesus is alive for evermore. And He is the living hope of God's people that one day, they, too, will live face to face with God forever! We can be God's people when we turn away from our sins and trust in Jesus as our Savior.

Some Questions for You

1. What kind of new birth does God offer to us, when we turn away from our sins and trust in Jesus as our Savior? *A new birth in our heart (not that we are born like babies again).*
2. What is this new birth in our heart like? *God forgives all of our sins. He fills our heart with His Holy Spirit. We want to know and love God. We want to live for Him.*
3. What did Jesus do that makes it possible for us to have this new birth in our hearts? *He died on the cross for the sins of God's people. He rose from the dead (was resurrected) on the third day, proving that He really had beaten sin and death for them.*
4. How can we become one of God's people? *By turning away from our sins and trusting in Jesus as our Savior.*

Let's Pray!

- A** Jesus, we praise You for being willing to leave the Perfect Wonderfulness of heaven to be our Savior. You came to bring us to God.
- C** You came to bring us to God because we are all sinners who deserve God's punishment. How we need You to be our Savior!
- T** Thank You, Jesus, for dying on the cross to save all who turn away from their sins and trust in You as their Savior.
- S** Work in our hearts. Help us to turn away from our sins. Help us to trust in You as our Savior. Help us to tell others about You. In Jesus' name we pray, Amen.

Let's Sing Our Bible Verse!

He Has Given Us a New Birth: 1 Peter 1:3, HCSB *from Deep Down Detectives ESV Songs 15, track 17*

He has given us a new birth,
Into a living hope,
He has given us a new birth,
Into a living hope,
Through the resurrection of Jesus Christ from the dead,
Through the resurrection of Jesus Christ from the dead.
He has given us a new birth,
Into a living hope,
He has given us a new birth,
Into a living hope.
First Peter One, three.

Which four of these clues belong in our story? Which two do not? Put an X in the boxes of the four that belong.

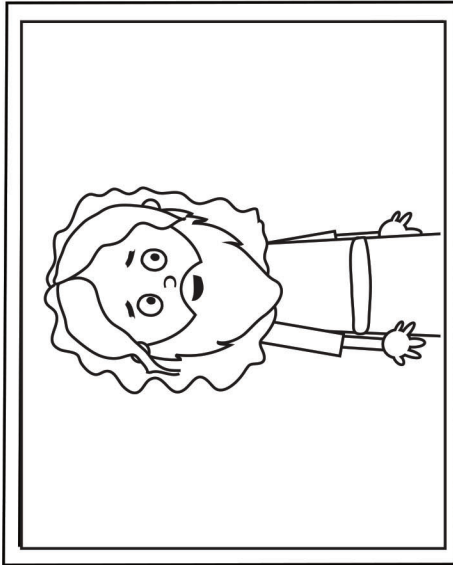

Jesus

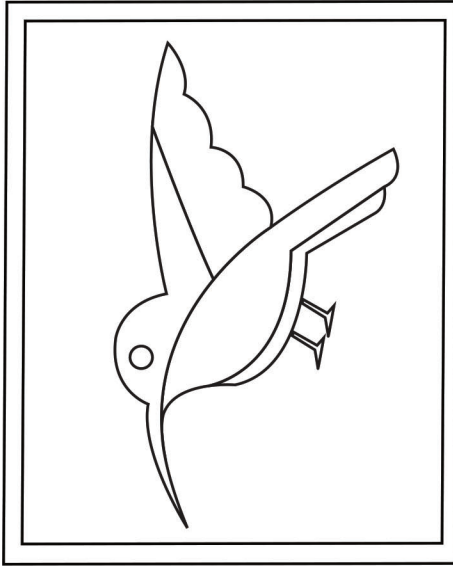

A Bird

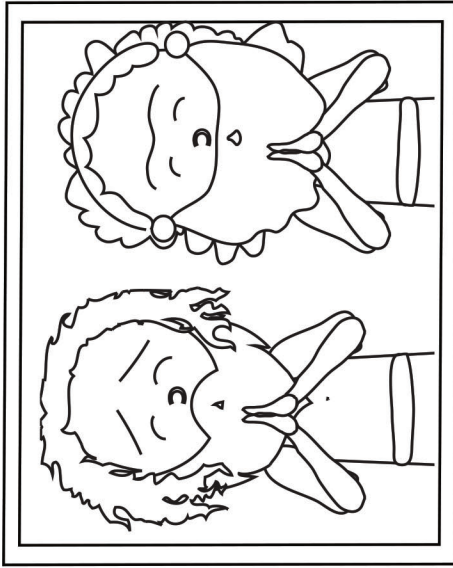

Praying Together

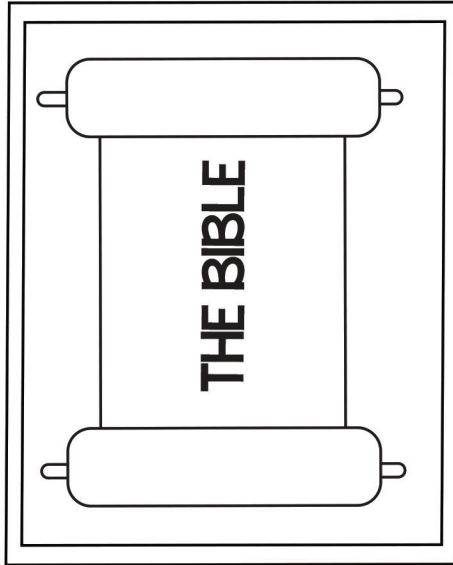

God's Word

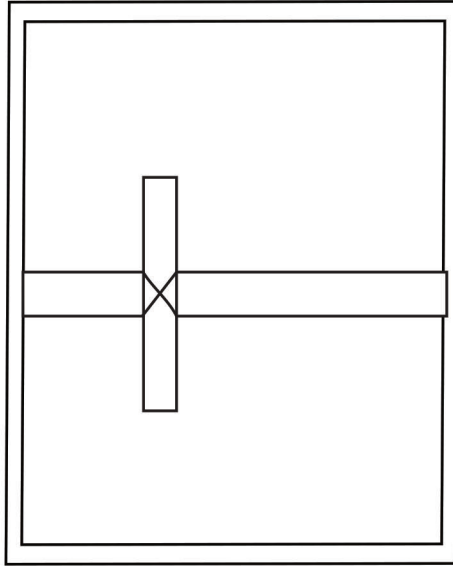

A Cross

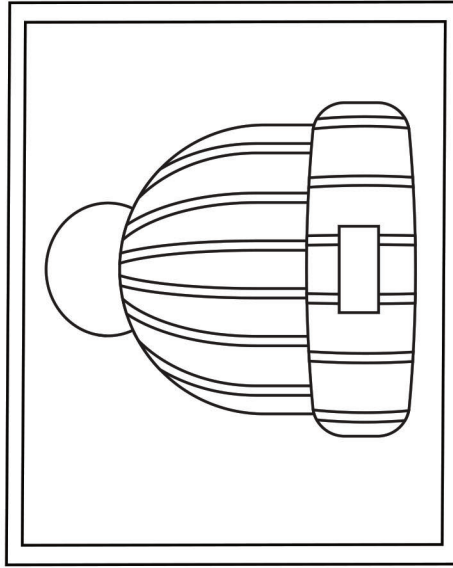

A Hat

Answer: Jesus, people praying, God's Word and the cross belong. The bird and the hat do not.

Deep Down Detective Devotion: Unit 15, Bible Truth 1, Lesson 3



Big Question 15: Why Do God's People Go to Church?

Answer: To Worship God and Love One Another... By Praising God for Jesus' Win over Death!

Bible Truth 1 Meaning

On one sad Friday, Jesus suffered and died on the cross for God's people. He was buried in a grave, but He didn't stay there. He rose up from the grave on Day Three—Sunday! He was alive and would be forevermore! Ever since that first and best Sunday when Jesus beat sin and death, God's people have been gathering together each week to celebrate. (The big, Bible word for God's people gathered together is "congregation.") They sing and pray and listen to God's Word. They rejoice that Jesus had beaten sin and death for them. They are happy the Holy Spirit lives in their hearts. They look forward to the day when Jesus will come back and all of God's people will at last gather together forever as one, big family. That will be the biggest and best celebration of all! Now all who turn away from their sins and trust in Jesus as their Savior receive God's forgiveness for their sins. He sends His Holy Spirit to live in their hearts and helps them love God and live for Him the rest of their lives. Forever they will be God's dearly-loved people! What an amazing gift God has given us through Jesus! God's people love to celebrate together, but they are always hoping for more to join them. That's why they tell their neighbors nearby the good news of Jesus. (The big, Bible word for telling others about Jesus is "evangelism.") And that's why they even travel to faraway lands to tell people there about Jesus, too. (The big, Bible word for going to another land to tell people about Jesus is "missions.") They want everyone to hear the good news of Jesus, repent of their sins and trust in Jesus as their Savior. (The big, Bible word for the good news of Jesus is "the gospel.") They want them all to become God's people and join the Sunday celebration of what God has done through Jesus! We can be God's people, too, when we turn away from our sins and trust in Jesus as our Savior. Sundays will be our celebration day, too!

How do I know this is true? The Bible tells me so!

"He has given us a new birth into a living hope through the resurrection of Jesus Christ from the dead." --1 Peter 1:3, HCSB

Some Questions for You

1. Where did God's people go on the Sabbath that was different from the other days of the week? *They went to worship God and learn from His Word, the Bible.*
2. What happened that changed the day that God's people gathered together to worship God? *Jesus came. He died on the cross and then rose from the dead on the third day--a Sunday.*
3. Why did God's people start gathering together on the Sunday instead of the Sabbath? *To celebrate that Jesus rose from the dead on that first Sunday. They were celebrating Jesus' win over sin and death for God's people.*
4. What did Jesus tell His disciples to do, so that more and more might gather together with them and celebrate how He rose from the dead and beat sin and death? *To tell the good news of Jesus to their nearby neighbors and to those who lived in faraway lands, that they might all become God's people and live as His disciples.*
5. Do people at your church gather together on a Sunday? *Yes! Now you know why!*
6. How can we become God's people? How can Sunday become our special celebration day, too? *By turning away from our sins and trusting in Jesus as our Savior.*

Let's Pray!

- A** We praise You, God, for saving Your people, the Church. We praise You for being so powerful that You beat sin and death for them.
- C** God, we know that Sunday should be a special celebration day. It's the day Jesus rose from the dead. But sometimes, we would rather not go to church and celebrate. We would rather do something else that seems more fun. We don't treasure what Jesus did on the cross. We need a Savior!
- T** God, thank You for beating sin and death for God's people through Jesus. Thank You that they don't have to face Your punishment for sin. They get to know You in their hearts now, and get to live with You in heaven when they die. Thank You that we can be Your people, too, when we turn away from our sins and trust in Jesus as our Savior.
- S** God, work in our hearts. Help us to turn away from our sins and trust in Jesus as our Savior. Help us to celebrate Jesus' win over sin and death as we gather together with God's people at church. In Jesus' name we pray, Amen.

Let's Praise God Right Now!

Big Q & A 15 Hymn: Brethren, We Have Met to Worship

from *Deep Down Detectives ESV Songs 15, track 15*

Verse 1

Brethren, we have met to worship,
And adore the Lord, our God.
Will you pray with all your power,
While we try to preach the Word?

Words: George Atkins Music: William Moore

Go to the *Deep Down Detectives Parent Resources for Unit 15* to get the Bible story and many more resources and songs for this unit at praisefactory.org

Big Question 15 Praise Song: Praise the Lord Together

from *Deep Down Detectives ESV Songs 15, track 16*

Praise the Lord together saying:
"Hallelujah, Hallelujah, Hallelujah!"
Praise the Lord together saying:
"Hallelujah, Hallelujah, Hallelujah!" (repeat)

CAN YOU GUESS BIBLE TRUTH 2:
Why Do God's People Go to Church?
To Worship God and Love
One Another...

By Learning from God's Word, the

----- !

**HINT: What is the name of God's Word? It starts
with a "B" and it rhymes with "tribal."**

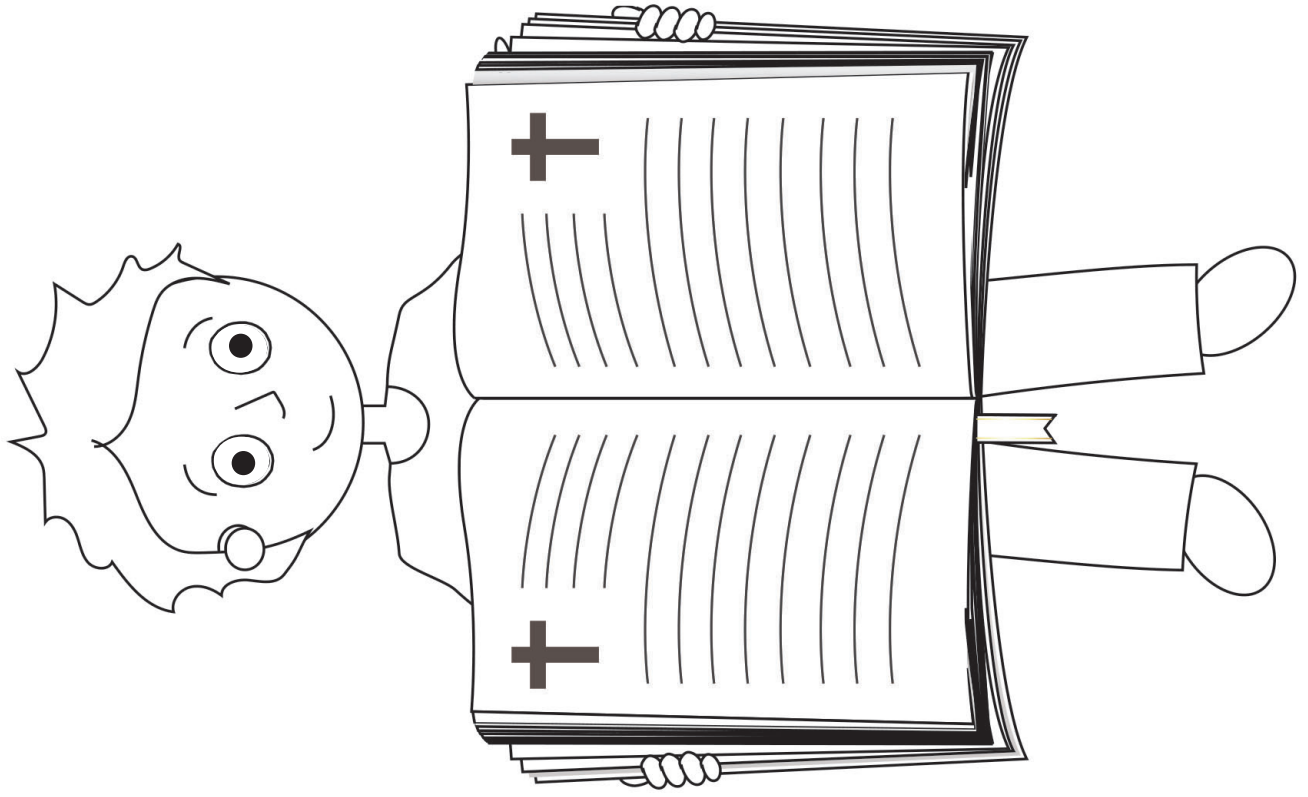

Deep Down Detective Devotion: Unit 15, Bible Truth 2, Lesson 1



Big Question 15: Why Do God's People Go to Church?

Answer: To Worship God and Love One Another... By Learning from God's Word, the Bible!

Bible Truth 2 Meaning

God's people gather together to learn from the Bible. There is no other book like it. It alone is God's Word. It is the best place to find out about God and how to obey Him. But that's not all! The Bible is not just words that God's people listen to and learn from. God's Word is powerful! The Holy Spirit works inside of people as they hear God's Word. He uses it to help them turn away from their sins and trust in Jesus as their Savior. This is how we become God's people. (The big, Bible word for this is "conversion.") And, He uses it to help us to know God better, to give us hope, and to obey Him. This is how we live as God's people. (The big, Bible word for this is "discipleship.") Sometimes God's people learn from the Bible in little groups. (You are probably learning about the Bible in one of these right now!) But the most important way God's people learn from God's Word is when they all gather together as a congregation and listen to a godly man preach from the Bible. The Bible calls these men, pastors (or elders). God has called them to preach God's Word and to lead God's people in living for Him. What a great gift they are to God's people! The pastor stands in front of the congregation (God's people gathered together). He reads to them from the Bible and explains what it means. He helps them understand how to live it out. (The big, Bible word for this is "expositional preaching.") The Holy Spirit helps the pastor and the congregation as they study God's Word together. It is very important for God's people to hear the Bible when they gather together. God uses it to work powerfully in their lives. We can be God's people, too, when we turn away from our sins and trust in Jesus as our Savior. God can use His Word to work powerfully in our lives, too.

How do I know this is true? The Bible tells me so!

"Devote yourself to the public reading of Scripture, to exhortation, to teaching." --1 Timothy 4:13, ESV

Some Questions for You

1. What is another word for God's Word, the Bible? *Scripture.*
2. What book tells God's people how God wants them to live? *The Bible does.*
3. How is the Bible powerful to do inside of God's people? *It is powerful to help them love God and live for Him.*
4. Where do God's people meet all together and listen to God's Word? *At church.*
5. Who teaches them about God's Word when they meet together? *Godly leaders.*
6. What do the godly leaders teach when they read God's Word? *What it tells us about God and how God wants us to live.*
7. What is the first, very wonderful thing that God can use His Word to do in our hearts when we listen to it? *God can use it to help us to turn away from our sins and trust in Jesus as our Savior. He can make us His people!*

Let's Pray!

- A** We praise You, God, for saving Your people, the Church. We praise You for giving us the Bible and godly leaders to teach it to us.
- C** God, sometimes we don't want to learn from the Bible. Sometimes, we don't want to listen to the pastors preach from Your Word. There are other things we would rather do. We need a Savior!
- T** God, thank You for not leaving us on our own, but giving us Your Word, the Bible, to learn from and to live by. Thank You for all the people in church who help us understand Your Word and live it out. Thank You for our pastors and teachers.
- S** God, work in our hearts. Help us to turn away from our sins and trust in Jesus as our Savior. Help us to love Your Word and learn it. Help us live it out. Help our pastors and teachers to teach us well about You. In Jesus' name we pray, Amen.

Let's Sing about What We're Learning!

Go to the Deep Down Detectives Parent Resources for Unit 15 to get the Bible story and many more resources and songs for this unit at praisefactory.org

Big Q & A 15 Song from *Deep Down Detectives ESV Songs 15, track 12* (sung to the tune of "This Is the Way We Wash Our Clothes")

Why do God's people go to church?
Go to church? Go to church?
Why do God's people go to church?
To worship God and to love one another!

Big Question 15 Action Rhyme Song from *Deep Down Detectives ESV Songs 15, track 13*

Refrain:

Why do God's people go to church?
To worship God and love one another.
Why do God's people go to church?
To worship God and love one another.

Verse 1:

A church is God's people,
Gathered together.
It's not a building of bricks.
It's made up of people,
Who follow Jesus,
In faith and repentance. *Refrain*

Verse 2

God's people gather to worship God.
To sing His praises and pray.
They listen to preaching,
From God's Word, the Bible,
To better love Him each day.
Refrain

Verse 3

God's people gather to love one another,
In acts of kindness and grace.
They love one another,
Like sisters and brothers,
Helping all to live God's way.
Refrain

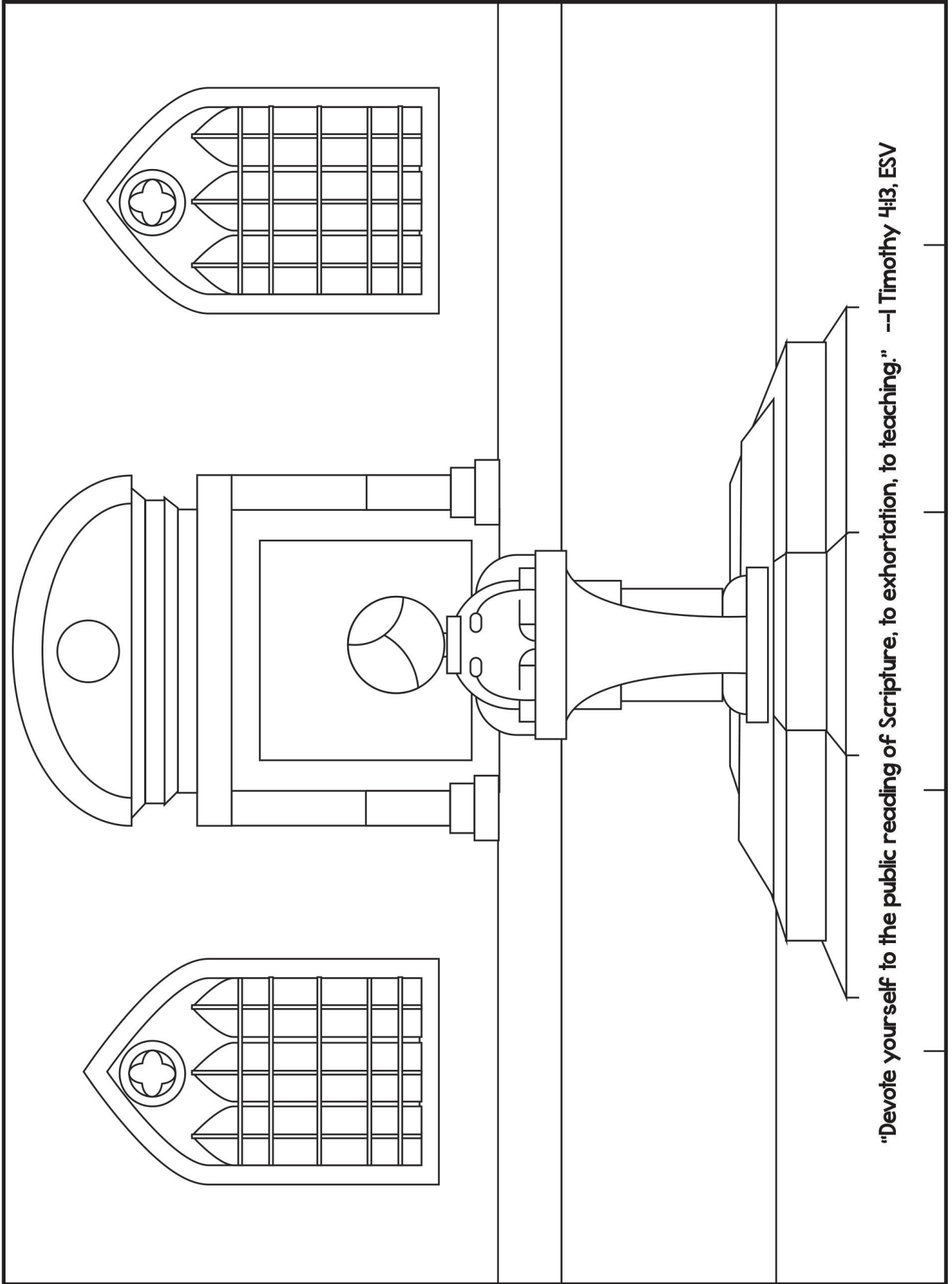

"Devote yourself to the public reading of Scripture, to exhortation, to teaching." --1 Timothy 4:13, ESV

Deep Down Detective Devotion: Unit 15, Bible Truth 2, Lesson 2

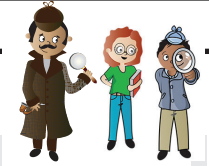

Big Question 15: Why Do God's People Go to Church?

Answer: To Worship God and Love One Another... By Learning from God's Word, the Bible!

How do I know this is true? The Bible tells me so:

"Devote yourself to the public reading of Scripture, to exhortation, to teaching." --1 Timothy 4:13, ESV

Learn a Little: "Devote yourself to the reading of Scripture."

Meaning:

God's people gather together to worship God and love one another. And what book tells them how to do this best of all? God's Word, the Bible! The Bible helps God's people know how God wants them to live; and, it is powerful to help them live that way. No wonderful God's people devote themselves to the Bible. They want their leaders to read it to them and to teach them what it means when they gather together. It alone is God's Word! We can become God's people when we turn away from our sins and trust in Jesus as our Savior. God can use His Word to work powerfully in our lives, too.

Some Questions for You

1. What is another word for God's Word, the Bible? *Scripture.*
2. What book tells God's people how God wants them to live? *The Bible does.*
3. How is the Bible powerful to do inside of God's people? *It is powerful to help them love God and live for Him.*
4. Where do God's people meet all together and listen to God's Word? *At church.*
5. Who teaches them about God's Word when they meet together? *Godly leaders.*
6. What do the godly leaders teach when they read God's Word? *What it tells us about God and how God wants us to live.*
7. What is the first, very wonderful thing that God can use His Word to do in our hearts when we listen to it? *God can use it to help us to turn away from our sins and trust in Jesus as our Savior. He can make us His people!*

Let's Pray!

- A** We praise You, God, for saving Your people, the Church. We praise You for giving us the Bible and godly leaders to teach it to us.
- C** God, sometimes we don't want to learn from the Bible. Sometimes, we don't want to listen to the pastors preach from Your Word. There are other things we would rather do. We need a Savior!
- T** God, thank You for not leaving us on our own, but giving us Your Word, the Bible, to learn from and to live by. Thank You for all the people in church who help us understand Your Word and live it out. Thank You for our pastors and teachers.
- S** God, work in our hearts. Help us to turn away from our sins and trust in Jesus as our Savior. Help us to love Your Word and learn it. Help us live it out. Help our pastors and teachers to teach us well about You. In Jesus' name we pray, Amen.

Let's Sing Our Bible Verse!

Devote Yourself: 1 Timothy 4:13, ESV

from Deep Down Detectives ESV Songs 15, track 27

Devote yourself, devote yourself,
Devote yourself, devote yourself,
Devote yourself, devote yourself,
Devote yourself, devote yourself.

To the public reading of Scripture,
Exhortation, and teaching,
To the public reading of Scripture,
Exhortation, and teaching.

Devote yourself, devote yourself,
Devote yourself, devote yourself,
Devote yourself, devote yourself,
Devote yourself, devote yourself.
First Timothy Four, thirteen.

Go to the [Deep Down Detectives Parent Resources for Unit 15](http://praisefactory.org) to get the Bible story and many more resources and songs for this unit at praisefactory.org

Which four of these clues belong in our story? Which two do not? Put an X in the boxes of the four that belong.

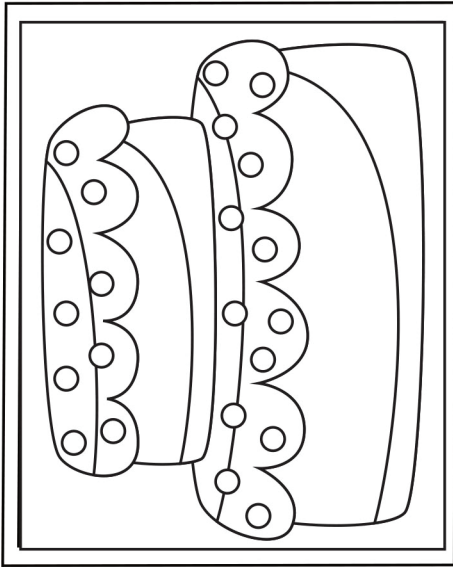

A Cake

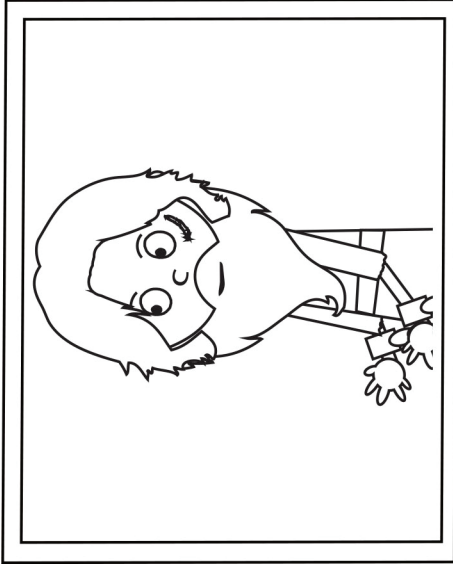

paul

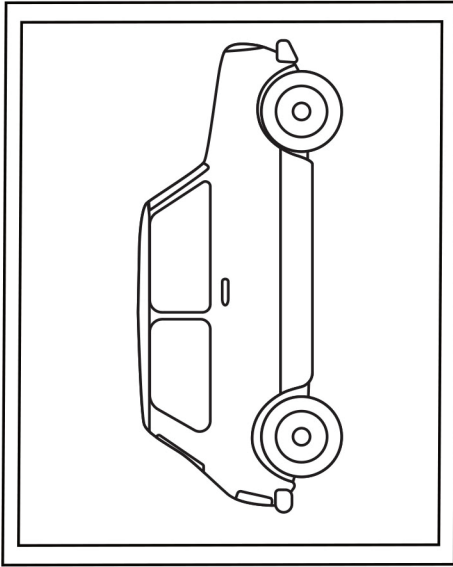

A Car

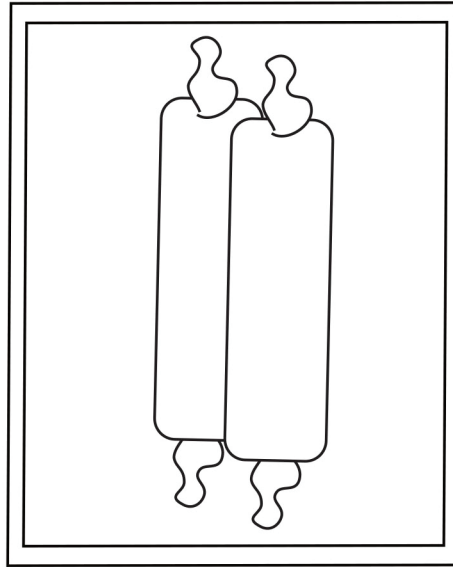

A Letter

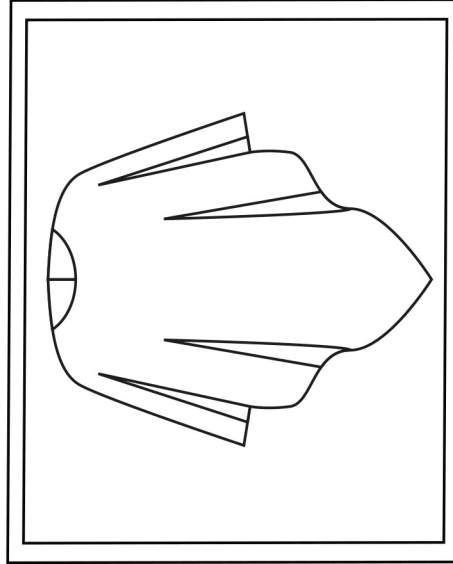

A Coat

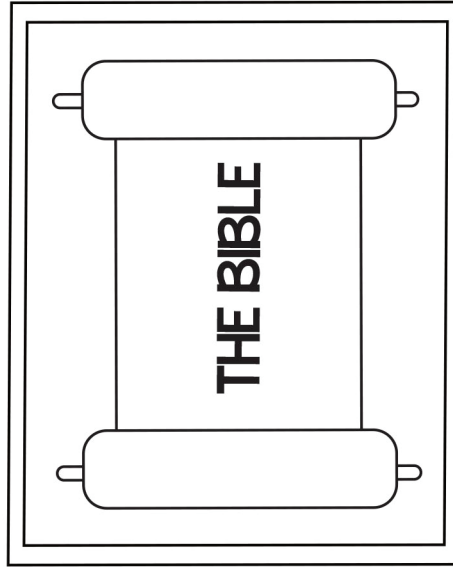

God's Word

Answers: Paul, the letter, the coat and God's Word belong. The cake and the car do not.

Deep Down Detective Devotion: Unit 15, Bible Truth 2, Lesson 3



Big Question 15: Why Do God's People Go to Church?

Answer: To Worship God and Love One Another... By Learning from God's Word, the Bible!

Bible Truth 2 Meaning

God's people gather together to learn from the Bible. There is no other book like it. It alone is God's Word. It is the best place to find out about God and how to obey Him. But that's not all! The Bible is not just words that God's people listen to and learn from. God's Word is powerful! The Holy Spirit works inside of people as they hear God's Word. He uses it to help them turn away from their sins and trust in Jesus as their Savior. This is how we become God's people. (The big, Bible word for this is "conversion.") And, He uses it to help us to know God better, to give us hope, and to obey Him. This is how we live as God's people. (The big, Bible word for this is "discipleship.") Sometimes God's people learn from the Bible in little groups. (You are probably learning about the Bible in one of these right now!) But the most important way God's people learn from God's Word is when they all gather together as a congregation and listen to a godly man preach from the Bible. The Bible calls these men, pastors (or elders). God has called them to preach God's Word and to lead God's people in living for Him. What a great gift they are to God's people! The pastor stands in front of the congregation (God's people gathered together). He reads to them from the Bible and explains what it means. He helps them understand how to live it out. (The big, Bible word for this is "expositional preaching.") The Holy Spirit helps the pastor and the congregation as they study God's Word together. It is very important for God's people to hear the Bible when they gather together. God uses it to work powerfully in their lives. We can be God's people, too, when we turn away from our sins and trust in Jesus as our Savior. God can use His Word to work powerfully in our lives, too.

How do I know this is true? The Bible tells me so!

"Devote yourself to the public reading of Scripture, to exhortation, to teaching." --1 Timothy 4:13, ESV

Some Questions for You

1. Where was Paul? *He was in prison in Rome. His enemies put him there for telling people about Jesus, and now they planned to kill him.*
2. Whom did Paul write to before he died? *Timothy.*
3. What was so special about Timothy? *Timothy had been Paul's special helper. He cared for Paul. He loved God, God's Word, and he cared for God's people. He was like a son to Paul.*
4. Where did Paul leave Timothy? *What did he want him to do? He left him as the pastor, the godly leader, of the church in a city called Ephesus. They needed a good pastor who would teach them God's Word and help them live it out. Paul knew Timothy would do a good job.*
5. What did Paul tell Timothy to remember? *To keep on preaching God's Word, even when it is very hard. To keep on loving and caring for the believers at that little church in Ephesus. He also wanted him to come to visit him, if he could.*
6. What is the good news of Jesus that Paul and Timothy wanted everyone to know? *That we can become God's people when we turn away from our sins and trust in Jesus as our Savior. God can help us do this, too! Ask Him to help you to become one of His people!*

Let's Pray!

- A** We praise You, God, for saving Your people, the Church. We praise You for giving us the Bible and godly leaders to teach it to us.
- C** God, sometimes we don't want to learn from the Bible. Sometimes, we don't want to listen to the pastors preach from Your Word. There are other things we would rather do. We need a Savior!
- T** God, thank You for not leaving us on our own, but giving us Your Word, the Bible, to learn from and to live by. Thank You for all the people in church who help us understand Your Word and live it out. Thank You for our pastors and teachers.

God, work in our hearts. Help us to turn away from our sins and trust in Jesus as our Savior. Help us to love Your Word and learn it. Help us live it out. Help our pastors and teachers to teach us well about You. In Jesus' name we pray, Amen.

Let's Praise God Right Now!

Big Q & A 15 Hymn: Brethren, We Have Met to Worship

from *Deep Down Detectives ESV Songs 15, track 15*

Verse 1

Brethren, we have met to worship,
And adore the Lord, our God.
Will you pray with all your power,
While we try to preach the Word?

Words: George Atkins Music: William Moore

Go to the *Deep Down Detectives Parent Resources for Unit 15* to get the Bible story and many more resources and songs for this unit at praisefactory.org

Big Question 15 Praise Song: Praise the Lord Together

from *Deep Down Detectives ESV Songs 15, track 16*

Praise the Lord together saying:

"Hallelujah, Hallelujah, Hallelujah!"

Praise the Lord together saying:

"Hallelujah, Hallelujah, Hallelujah!" (repeat)

CAN YOU GUESS BIBLE TRUTH 3:
Why Do God's People Go to Church?
To Worship God and Love
One Another...

By Caring for Each Other's

----- !

**HINT: This word means "something we
have to have." It starts with an "n" and it
rhymes with "seeds."**

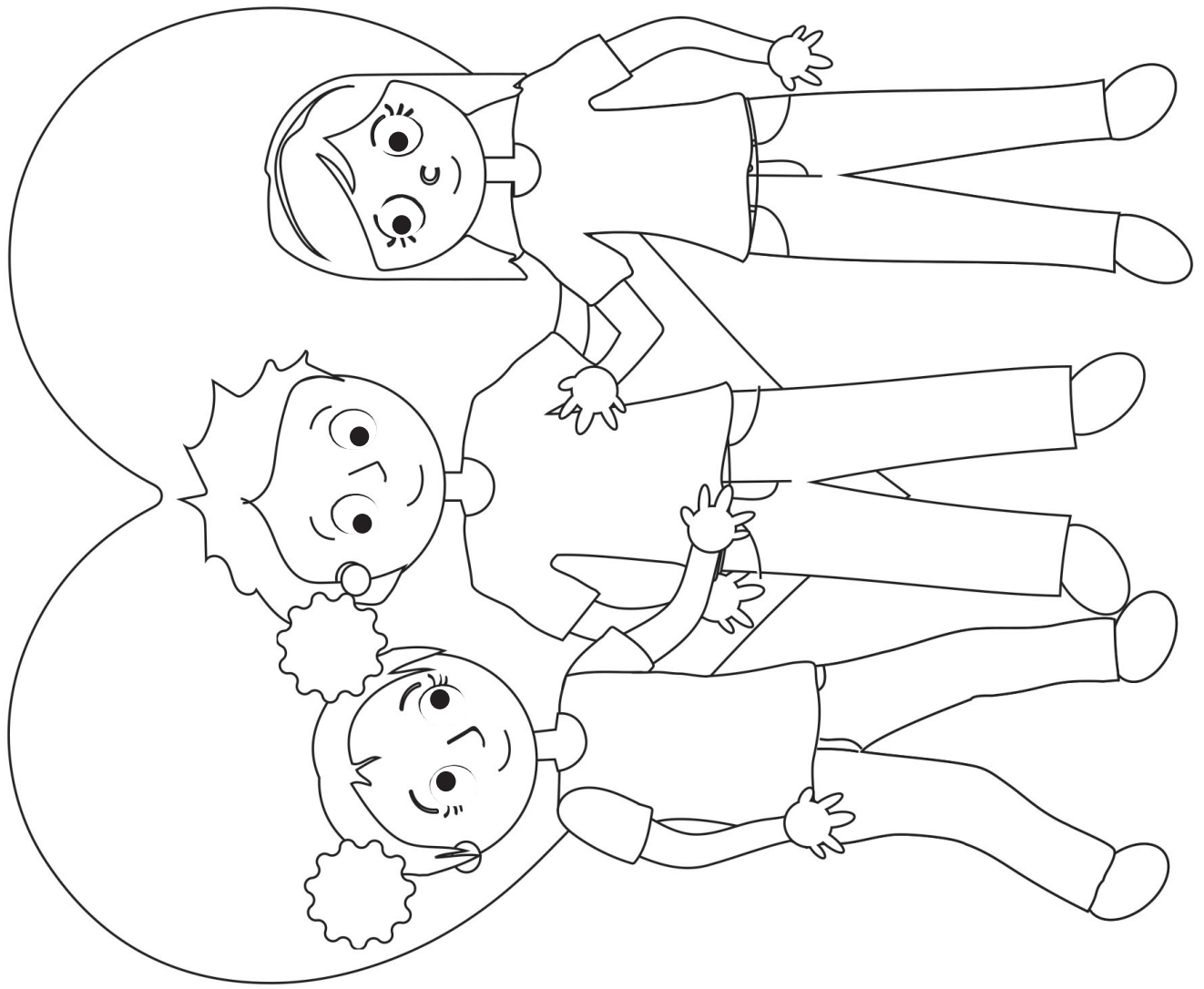

Deep Down Detective Devotion: Unit 15, Bible Truth 3, Lesson 1



Big Question 15 : How Can I Know What God Is Like?

Answer: To Worship God and Love One Another... By Caring for Each Other's Needs!

Bible Truth 3 Meaning

When God's people gather together, they make special promises to believe God's Word and to care for each other. They promise to help each other keep on loving God and living for Him. How do God's people help each other keep these promises? They help each other love God and live for Him. They tell each other about their lives—the many happy things, the sad things, even their sins and their struggles. They pray for each other and remind each other of the truths in God's Word. They want to help everyone to keep growing in their life with God. But they also care for each other's needs. They share their money and their things when someone is hungry or has lost their job. They visit each other when they are sick. They cheer each other up when they are sad or lonely. They want to help everyone to be well-cared for. God gives each little church special leaders that help them care for each other, too. He gives them pastors/elders to teach them God's Word and help them live it out. They comfort those who are scared and weak. They strengthen those who are struggling with sin. They pray for all. God gives each little church special leaders called deacons, too. Deacons help everyone to better care for each other's needs. They spend extra time finding out what people need and helping them get it. Jesus told God's people to love each other and take care of each other just as He has loved and taken care of them. If they do this, Jesus promised that others will see their love and know that they are God's people. They will praise God for how wonderful He is and want to become His people, too. We can become God's people when we turn away from our sins and trust in Jesus as our Savior.

How do I know this is true? The Bible tells me so!

"A new commandment I give to you, that you love one another: just as I have loved you, you also are to love one another. By this all people will know that you are my disciples, if you have love for one another." --John 13:34-35, ESV

Some Questions for You

1. What do God's people promise to do for each other? *They promise to care for each other's needs.*
2. How do pastors/elders care for the needs of God's people? *They teach them God's Word. They comfort them when they are sad; they warn them when they are forgetting how to live as God's people. They give them guidance and pray for them. They help them love God and live for Him.*
3. What kinds of things do God's people share with each other when they gather together? *Happy things as well as sadnesses and troubles.*
4. Why do God's people share with each other? *To help each other and to pray for each other.*
5. What kinds of loving things do God's people do for each other? *They pray for each other; they share their money; they visit them when they are sick; they cheer them up when they are sad or lonely.*
6. What does God call deacons to do for God's people? *They help God's people to better care for each other's needs. They spend extra time finding out what people need and helping them get it.*
7. Who will see how wonderful God is when God's people care for each other well? *Everyone, even those who don't trust Jesus as their Savior yet.*
8. How can we become God's people? *By turning away from our sins and trusting in Jesus as our Savior.*

Let's Pray!

- A** We praise You, God, for being the Savior of Your people, the Church. We praise You for Your kindness and love shown through Your people caring for each other.
- C** God, sometimes we don't want to go to church and care for the needs of others. Sometimes we just want to take care of our own needs. We need a Savior!
- T** Thank You, God, for giving Your people to each other to care for their needs. Thank You for all the people in church who care for our needs.
- S** God, work in our hearts. Help us to turn away from our sins and trust in Jesus as our Savior. Make us Your people! Help us to care for others when we gather at church. In Jesus' name we pray, Amen.

Let's Sing about What We're Learning!

Big Q & A 15 Song from *Deep Down Detectives ESV Songs 15, track 12* (sung to the tune of "This Is the Way We Wash Our Clothes")

Why do God's people go to church?
Go to church? Go to church?
Why do God's people go to church?
To worship God and to love one another!

Big Question 15 Action Rhyme Song from *Deep Down Detectives ESV Songs 15, track 13*

Refrain:

Why do God's people go to church?
To worship God and love one another.
Why do God's people go to church?
To worship God and love one another.

Verse 1:

A church is God's people,
Gathered together.
It's not a building of bricks.
It's made up of people,
Who follow Jesus,
In faith and repentance.
Refrain

Verse 2

God's people gather to
worship God.
To sing His praises and pray.
They listen to preaching,
From God's Word, the Bible,
To better love Him each day.
Refrain

Verse 3

God's people gather to
love one another,
In acts of kindness and grace.
They love one another,
Like sisters and brothers,
Helping all to live God's way.
Refrain

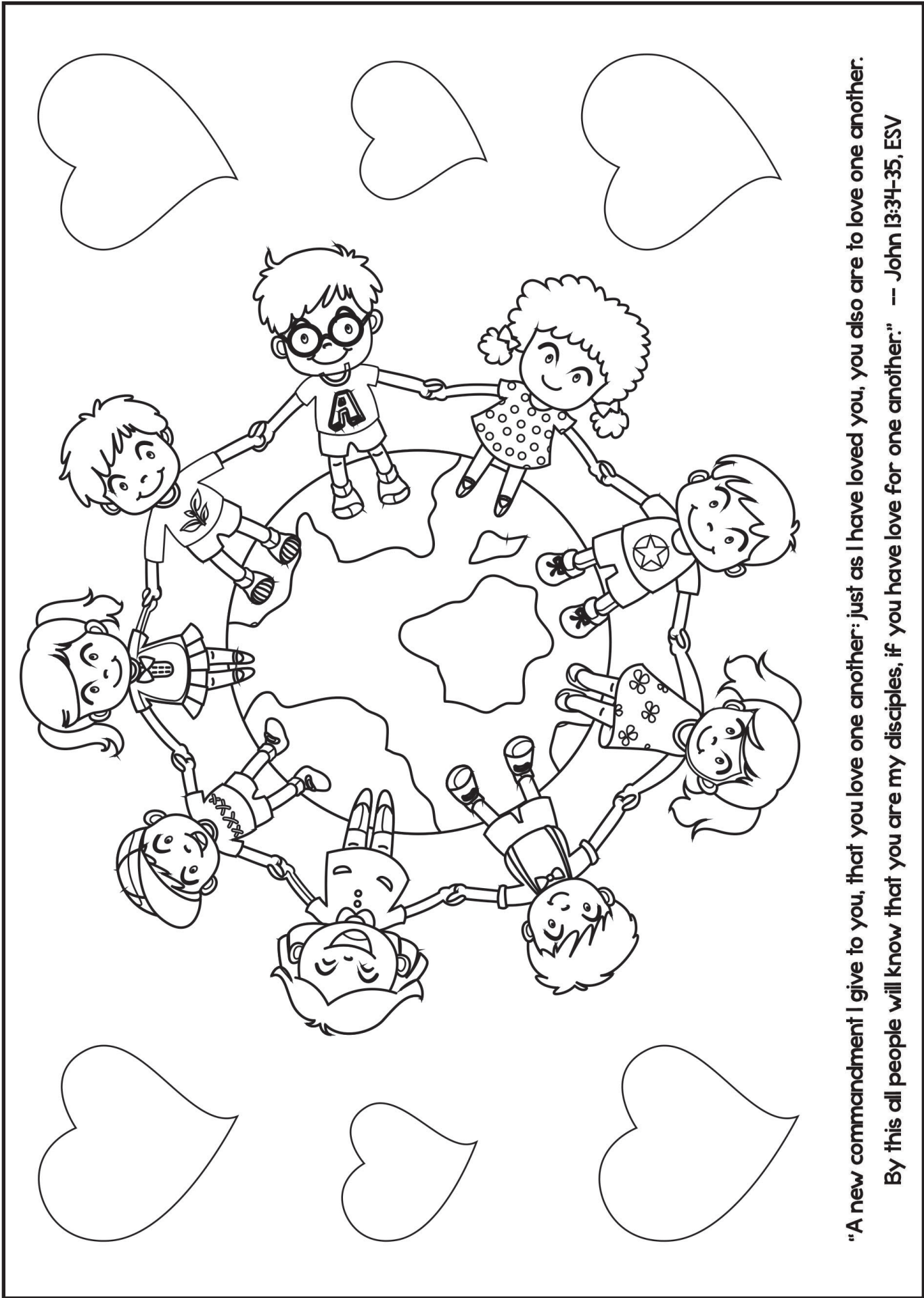

"A new commandment I give to you, that you love one another: just as I have loved you, you also are to love one another. By this all people will know that you are my disciples, if you have love for one another." -- John 13:34-35, ESV

Deep Down Detective Devotion: Unit 15, Bible Truth 3, Lesson 2



Big Question 15 : How Can I Know What God Is Like?

Answer: To Worship God and Love One Another... By Caring for Each Other's Needs!

How do I know this is true? The Bible tells me so!

"A new commandment I give to you, that you love one another: just as I have loved you, you also are to love one another. By this all people will know that you are my disciples, if you have love for one another." --John 13:34-35, ESV

Learn a Little: "Love one another: just as I have loved you."

Meaning

A commandment is a big rule God tells us to obey! What does Jesus command His people to do? To love one another like He has loved them! Wow! That's a lot of love! Only with God's help can God's people do that! But when they do, others will know that they really are God's people! We can become God's people when we turn away from our sins and trust in Jesus as our Savior.

Some Questions for You

1. What is a commandment? *It is a big rule God tells us to obey.*
2. What did Jesus command His people to do? *To love one another as He had loved them.*
3. How is Jesus' love for God's people different from how they should love each other? *He was the one and only, perfect, Son of God, sent to suffer and die for their sins. He was their Savior. He doesn't mean that God's people can (or should) do this for each other.*
4. How is Jesus love for God's people the same as how they should love each other? *Jesus always loved others the way God's laws says to love. He always thought about what would be the best way to serve others. He was willing to put the needs of others first. God's people can also love others in these ways.*
5. What did Jesus say others would know, if God's people loved each other the way Jesus loved them? *Everyone would know that they were His disciples (His followers/God's people).*
6. Who must help God's people if they are to love each other as Jesus has loved them? *God must.... and He does, by His Holy Spirit living in their hearts.*
7. How can we become God's people? *By turning away from our sins and trusting in Jesus as our Savior.*

Let's Pray!

- A** We praise You, God, for being the Savior of Your people, the Church. We praise You for Your kindness and love shown through Your people caring for each other.
- C** God, sometimes we don't want to go to church and care for the needs of others. Sometimes we just want to take care of our own needs. We need a Savior!
- T** Thank You, God, for giving Your people to each other to care for their needs. Thank You for all the people in church who care for our needs.
- S** God, work in our hearts. Help us to turn away from our sins and trust in Jesus as our Savior. Make us Your people! Help us to care for others when we gather at church. In Jesus' name we pray, Amen.

Let's Sing Our Bible Verse!

A New Commandment: John 13:34-35, ESV _ from *Deep Down Detectives* ESV Songs 15, track 32

A new commandment I give to you,
A new commandment I give to you,
Love one another!
Love one another!
Love one another!

By this all will know that you are My disciples,
By this all will know that you are My disciples,
Love one another!
Love one another!
Love one another!

John Thirteen, thirty-four and thirty-five.

Which four of these clues belong in our story? Which two do not? Put an X in the boxes of the four that belong.

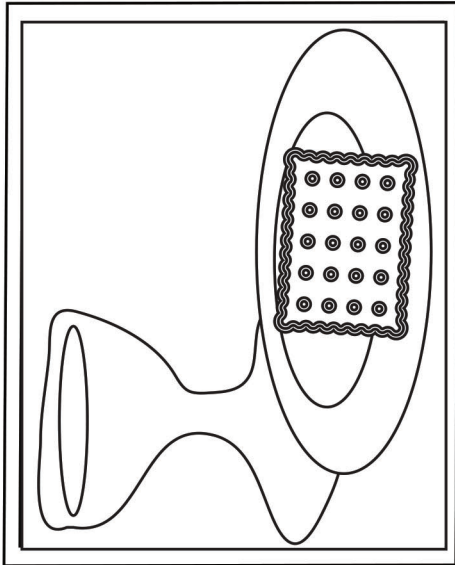

A Little Meal

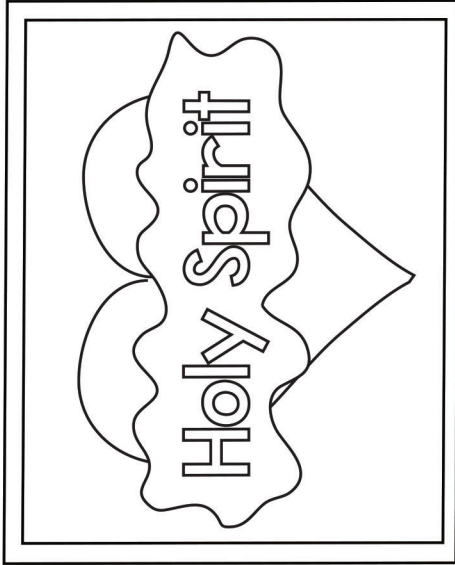

The Holy Spirit in a Heart

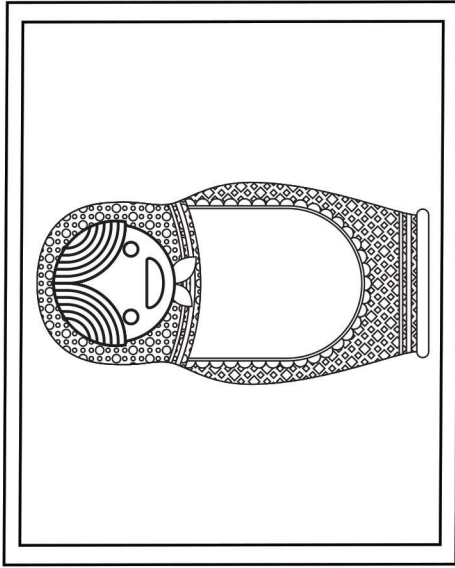

A Doll

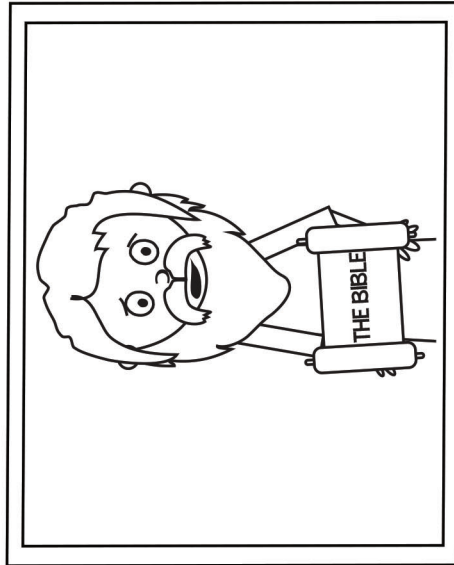

Pastor Peter

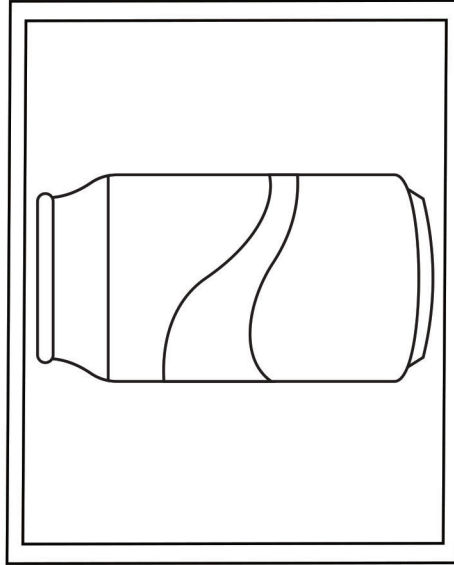

A Can of Soda

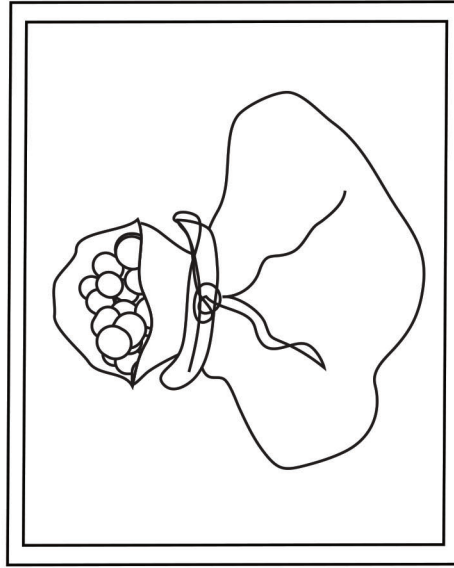

Some Money

Answer: The little meal, the Holy Spirit in a heart, Pastor Peter, and the money belong. The doll and the can of soda do not.

Deep Down Detective Devotion: Unit 15, Bible Truth 3, Lesson 3



Big Question 15 : How Can I Know What God Is Like?

Answer: To Worship God and Love One Another... By Caring for Each Other's Needs!

Bible Truth 3 Meaning

When God's people gather together, they make special promises to believe God's Word and to care for each other. They promise to help each other keep on loving God and living for Him. How do God's people help each other keep these promises? They help each other love God and live for Him. They tell each other about their lives—the many happy things, the sad things, even their sins and their struggles. They pray for each other and remind each other of the truths in God's Word. They want to help everyone to keep growing in their life with God. But they also care for each other's needs. They share their money and their things when someone is hungry or has lost their job. They visit each other when they are sick. They cheer each other up when they are sad or lonely. They want to help everyone to be well-cared for. God gives each little church special leaders that help them care for each other, too. He gives them pastors/elders to teach them God's Word and help them live it out. They comfort those who are scared and weak. They strengthen those who are struggling with sin. They pray for all. God gives each little church special leaders called deacons, too. Deacons help everyone to better care for each other's needs. They spend extra time finding out what people need and helping them get it. Jesus told God's people to love each other and take care of each other just as He has loved and taken care of them. If they do this, Jesus promised that others will see their love and know that they are God's people. They will praise God for how wonderful He is and want to become His people, too. We can become God's people when we turn away from our sins and trust in Jesus as our Savior.

How do I know this is true? The Bible tells me so!

"A new commandment I give to you, that you love one another: just as I have loved you, you also are to love one another. By this all people will know that you are my disciples, if you have love for one another." --John 13:34-35, ESV

Some Questions for You

1. What did Jesus tell His disciples He was going to do on the cross? *He would die to pay for the sins of God's people. Then, on the third day, He would rise from the dead.*
2. Who did Jesus say He would send them to help them? *The Holy Spirit, to live inside their hearts. He would give them the courage and wisdom and power to do everything God wanted them to do.*
3. How did Jesus tell His followers that they should love each other? *They should love each other and care for each other, just as He had loved and cared for them.*
4. What did these believers do after Jesus rose from the dead? *They fellowshiped together, sharing stories about the amazing things God was doing. They ate the Lord's Supper together to remember His death. They prayed to God.*
5. What did the believers do after Jesus rose from the dead to love each other as Jesus loved them? *They helped each other love God and live for Him, by learning the Bible. They shared everything they had to care for each other's needs. They even sold their own things to get money to buy things for other Christians who need something.*
6. Who cared for the believers by preaching God's Word and helping them live it out? *Peter and the other disciples who had been with Jesus. They were the pastors/elders of this little church.*
7. Who cared for the believers by helping them make sure everyone's needs were taken care of? *Deacons, like Stephen and Philip.*
8. What did others think when they saw how the Christians loved each other? *They knew that these people must be followers of Jesus. They wanted to hear the good news of Jesus.*
9. What is the good news of Jesus? *That Jesus died for the sins of all who turn away from their sins and trust in Jesus as their Savior. This is how we can become God's people!*

Let's Pray!

- A** We praise You, God, for being the Savior of Your people, the Church. We praise You for Your kindness and love shown through Your people caring for each other.
- C** God, sometimes we don't want to go to church and care for the needs of others. Sometimes we just want to take care of our own needs. We need a Savior!
- T** Thank You, God, for giving Your people to each other to care for their needs. Thank You for all the people in church who care for our needs.
- S** God, work in our hearts. Help us to turn away from our sins and trust in Jesus as our Savior. Make us Your people! Help us to care for others when we gather at church. In Jesus' name we pray, Amen.

Let's Praise God Right Now!

Big Q & A 15 Hymn: Brethren, We Have Met to Worship

from *Deep Down Detectives ESV Songs 15, track 15*

Verse 1

Brethren, we have met to worship,
And adore the Lord, our God.
Will you pray with all your power,
While we try to preach the Word?

Words: George Atkins Music: William Moore

Big Question 15 Praise Song: Praise the Lord Together

from *Deep Down Detectives ESV Songs 15, track 16*

Praise the Lord together saying:
"Hallelujah, Hallelujah, Hallelujah!"
Praise the Lord together saying:
"Hallelujah, Hallelujah, Hallelujah!" (repeat)

Go to the *Deep Down Detectives Parent Resources for Unit 15* to get the Bible story and many more resources and songs for this unit at praisefactory.org

DDD BQ 15 BT 3 L3 Coloring Sheet/Take Home pg2

CAN YOU GUESS BIBLE TRUTH 4:
Why Do God's People Go to Church?
To Worship God and Love
One Another...

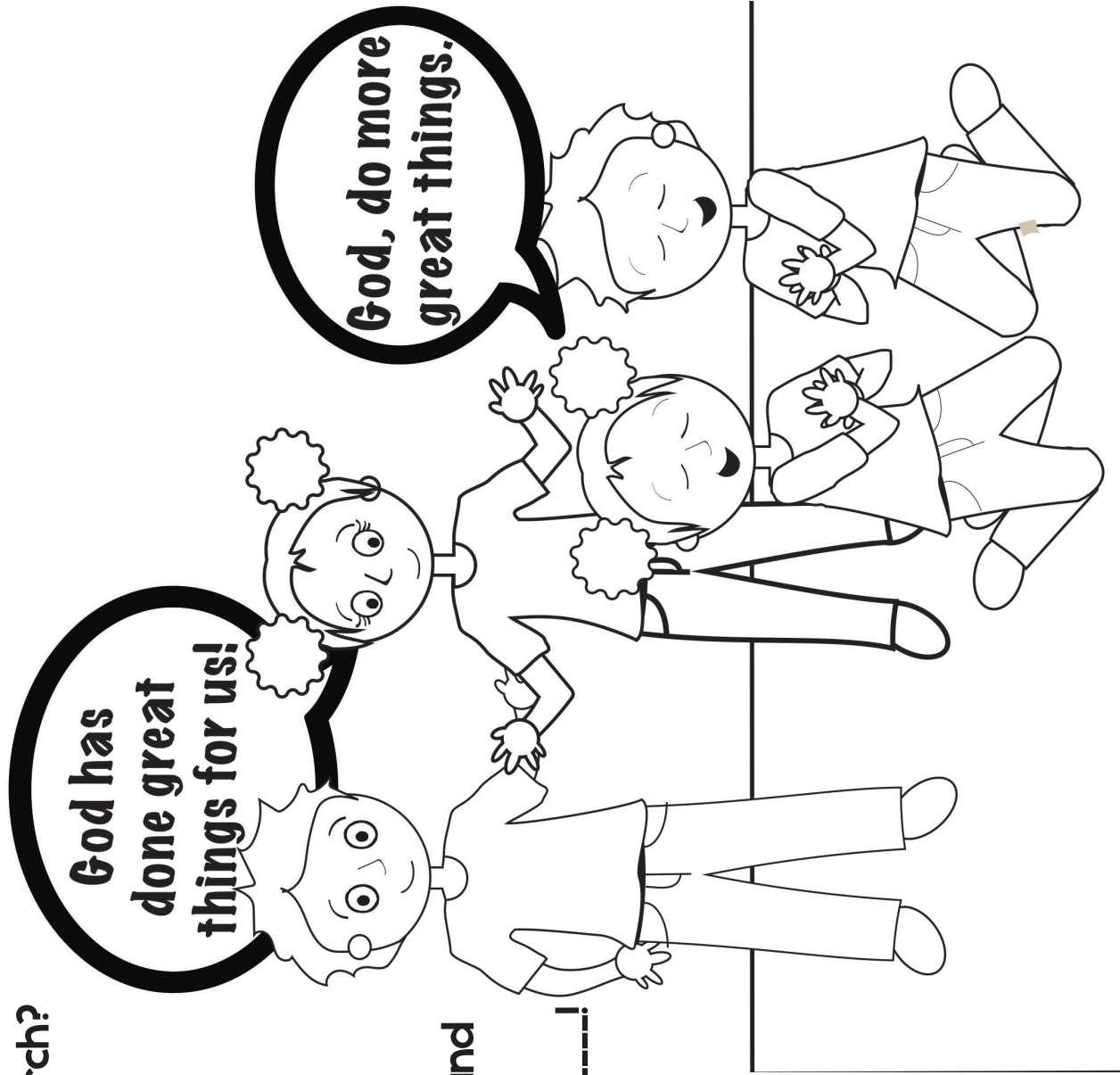

By Telling What God Has Done and

HINT: What is the Bible word for
talking with God? It starts with
a "p" and it rhymes with "playing."

Deep Down Detective Devotion: Unit 15, Bible Truth 4, Lesson 1



Big Question 15 : How Can I Know What God Is Like?

Answer: To Worship God and Love One Another... By Caring for Each Other's Needs!

Bible Truth 4 Meaning

When God's people gather together, they share with each other wonderful things God has done. They remind each other of the great things God did long ago in Bible times: how God always kept all His promises and did mighty things to save His people. They hear stories about how God has been at work around the world, bringing many other people to put their trust in Jesus as their Savior. They share with each other how God has been at work in their lives, caring for them and helping them live for Him. Oh, how faithful God has been to His people! Oh, how faithful God continues to be to them! All these stories of God's goodness and faithful helps them to keep on trusting God and living for Him. But God's people don't just talk to each other about what God has done. They also talk to God about them! All these stories of them. They praise and thank Him for what He has done. They confess ways they have disobeyed Him and seek His forgiveness. They ask Him to do more great things, in their lives and around the world. God delights in His people gathering together to pray. Jesus tells us in the Bible that when two or more of God's people are gathered together and praying that He will be there with them in a special way. Whether on their own or gathered together, God's people know God will always answer their prayers in the way He knows is best. We can become God's people, too, when we turn away from our sins and trust in Jesus as our Savior.

How do I know this is true? The Bible tells me so!

"Pray at all times in the Spirit with every prayer and request, and stay alert in this with all perseverance and intercession for all the saints."
--Ephesians 6:18, HCSB

Some Questions for You

1. What kinds of things do God's people share with each other when they gather together? *The many, wonderful things God has done.*
2. What do they want to do when they hear what God has been doing? *They want to praise God and trust Him even more.*
3. Who else do they talk to about what they share, besides each other? *God.*
4. What kinds of things do God's people pray about? *They praise Him; they confess their sins to Him; they thank Him; and, they ask Him to do great things.*
5. What is the best, first prayer that we can pray? *To ask God to help us to turn away from our sins and trust in Jesus as our Savior. This is we become God's people.*

Let's Pray!

A We praise You, God, for saving Your people, the Church. We praise You for Your faithfulness to Your people throughout all time.

God, sometimes we don't want to hear about all the wonderful things You've done for Your people. Sometimes, we don't want to pray

C for You to do more. We just want to think about ourselves and do what we want to do. We need a Savior!

T God, thank You for Your Word, the Bible, that tells us about the great things You did for Your people who lived long ago. Thank You for all You do for Your people today, all around the world. Thank You for letting us hear of Your mighty works, and for using them to help us to keep trusting in You and living for You. Thank You for hearing our prayers to do even more.

S God, work in our hearts. Help us to turn away from our sins and trust in Jesus as our Savior that we might become Your people. Help us to love hearing about the mighty things You have done, long ago and today. Help us to praise You more because of what You have done. Help us to trust You and live for You. Help us to encourage others who gather together with us. In Jesus' name we pray, Amen.

Let's Sing about What We're Learning!

Go to the Deep Down Detectives Parent Resources for Unit 15 to get the Bible story and many more resources and songs for this unit at praisefactory.org

Big Q & A 15 Song from *Deep Down Detectives ESV Songs 15, track 12* (sung to the tune of "This Is the Way We Wash Our Clothes")

Why do God's people go to church?
Go to church? Go to church?
Why do God's people go to church?
To worship God and to love one another!

Big Question 15 Action Rhyme Song from *Deep Down Detectives ESV Songs 15, track 13*

Refrain:
Why do God's people go to church?
To worship God and love one another.
Why do God's people go to church?
To worship God and love one another.

Verse 1:
A church is God's people,
Gathered together.
It's not a building of bricks.
It's made up of people,
Who follow Jesus,
In faith and repentance.
Refrain

Verse 2
God's people gather to
worship God.
To sing His praises and pray.
They listen to preaching,
From God's Word, the Bible,
To better love Him each day.
Refrain

Verse 3
God's people gather to
love one another,
In acts of kindness and grace.
They love one another,
Like sisters and brothers,
Helping all to live God's way.
Refrain

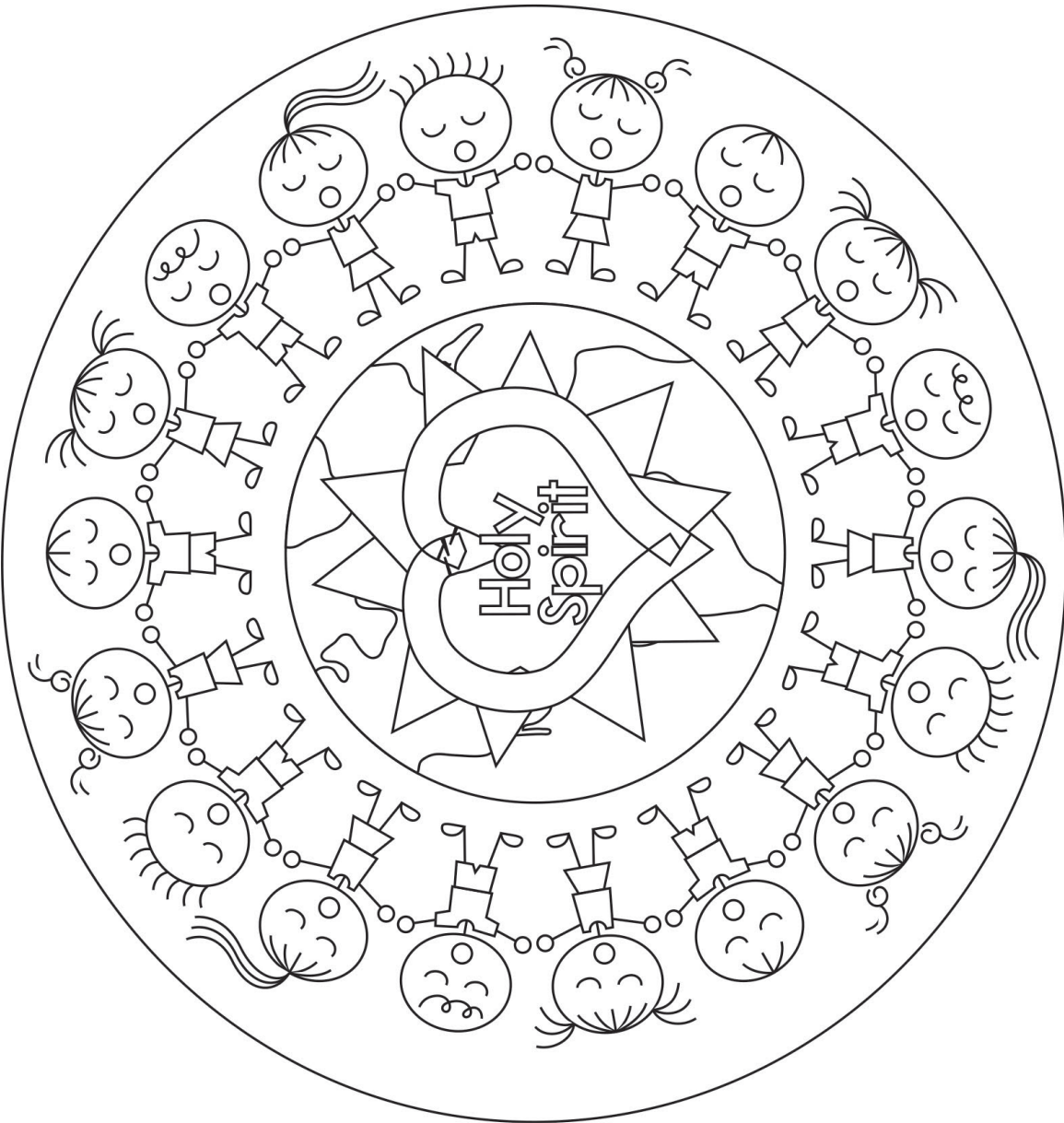

"Pray at all times in the Spirit with every prayer and request, and stay alert in this with all perseverance and intercession for all the saints." -- Ephesians 6:18, HCSB

Deep Down Detective Devotion: Unit 15, Bible Truth 4, Lesson 2



Big Question 15 : How Can I Know What God Is Like?

Answer: To Worship God and Love One Another... By Telling What God Has Done and Praying!

How do I know this is true? The Bible tells me so!

“Pray at all times in the Spirit with every prayer and request, and stay alert in this with all perseverance and intercession for all the saints.” --Ephesians 6:18, HCSB

Learn a Little: “Pray at all times... for all the saints.”

Meaning

“Saints” is a big, Bible word for God’s people. God’s people pray when they gather together at church. They praise God and they confess their sins to Him. They thank Him for all the ways He has cared for them. They ask Him to do more great things and to help them to love Him and live for Him. There is so much to pray for!

Sometimes God’s people get tired of praying. Sometimes God’s plans take much longer than they want. It would be easy to stop praying and give up. But there’s someone who helps God’s people keep on interceding (a big Bible word for praying for others). Who is it? It’s God, Himself. Yes, God’s Holy Spirit is at work inside of each of them helping them even to talk to God. We can become God’s people when we turn away from our sins and trust in Jesus as our Savior.

Some Questions for You

1. What are “saints?” *It is a big, Bible word for God’s people--all who turn away from their sins and trust in Jesus as their Savior.*
2. Who should keep on praying for “the saints,” God’s people? *God’s people should!*
3. When should God’s people pray? *On all occasions... all the time.*
4. What kinds of things do God’s people pray about when they gather together as a church? *They praise God and confess their sins to Him. They thank Him for how He has cared for them. They ask Him to do more, great things and to help them love Him and live for each other.*
5. How can we become one of God’s people? *We can ask God to help us to turn away from our sins and trust in Jesus as our Savior. He loves to answer these prayers!*

Let’s Pray!

- A** We praise You, God, for saving Your people, the Church. We praise You for Your faithfulness to Your people throughout all time.
- C** God, sometimes we don’t want to hear about all the wonderful things You’ve done for Your people. Sometimes, we don’t want to pray for You to do more. We just want to think about ourselves and do what we want to do. We need a Savior!
- T** God, thank You for Your Word, the Bible, that tells us about the great things You did for Your people who lived long ago. Thank You for all You do for Your people today, all around the world. Thank You for letting us hear of Your mighty works, and for using them to help us to keep trusting in You and living for You. Thank You for hearing our prayers to do even more.
- S** God, work in our hearts. Help us to turn away from our sins and trust in Jesus as our Savior that we might be Your people. Help us to love hearing about the mighty things You have done, long ago and today. Help us to praise You more because of what You have done. Help us to trust You and live for You. Help us to encourage others who gather together with us. In Jesus’ name we pray, Amen.

Let’s Sing Our Bible Verse!

Pray, Pray, Pray: Ephesians 6:18, from *Deep Down Detectives ESV Songs 15, track 43*

Pray, pray, pray in the Spirit!
Pray in the Spirit, at all times,
With ev’ry prayer and request,
Pray, pray, pray in the Spirit!

And stay alert in this,
Stay alert with all perseverance,
And intercession for all the saints,
For all the saints,
Pray, pray, pray in the Spirit!
Ephesians Six, eighteen.

Which four of these clues belong in our story? Which two do not? Put an X in the boxes of the four that belong.

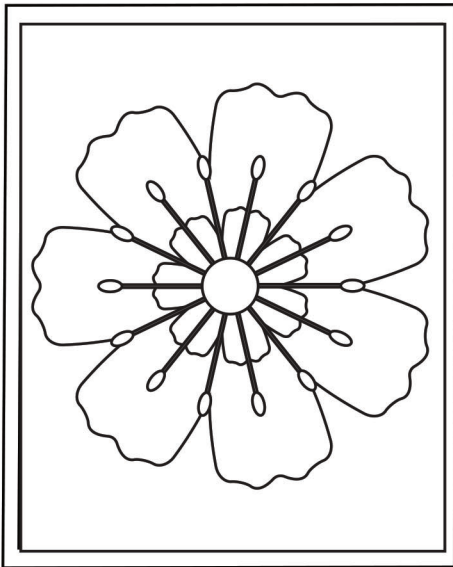

A Flower

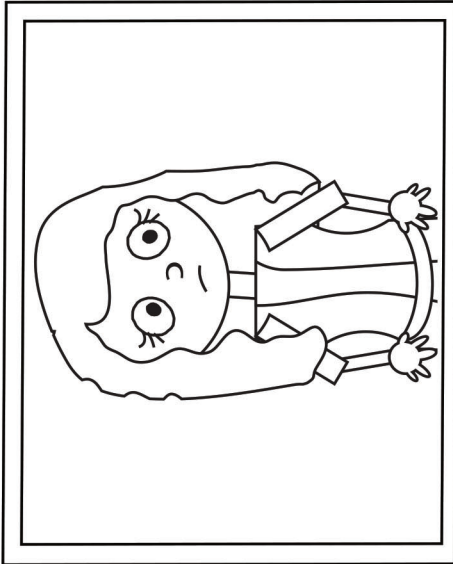

A Servant Girl

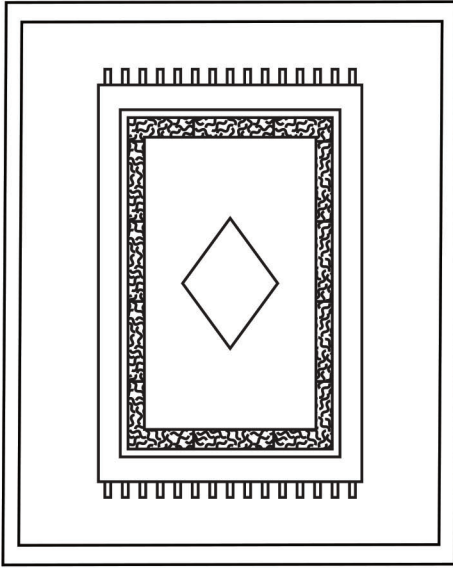

A Rug

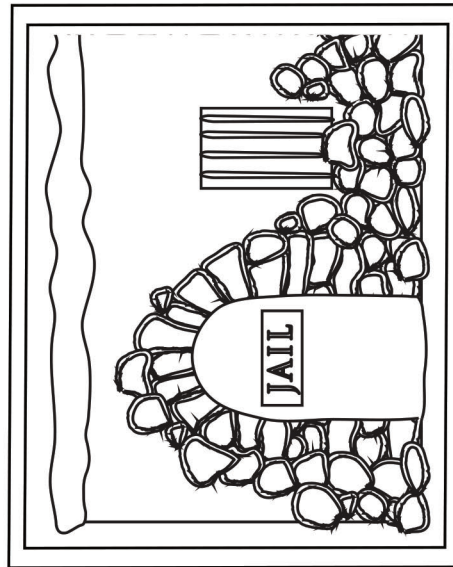

A Jail

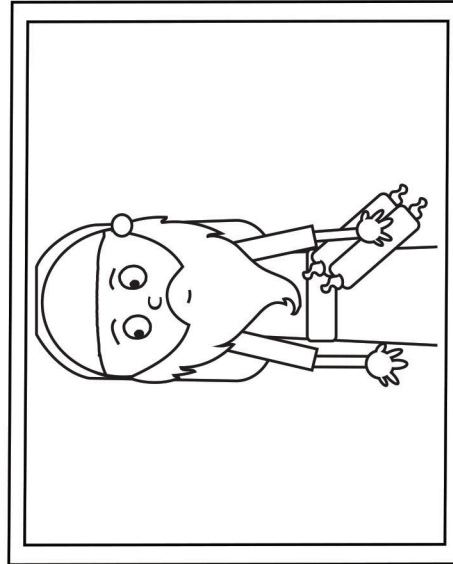

Leaders

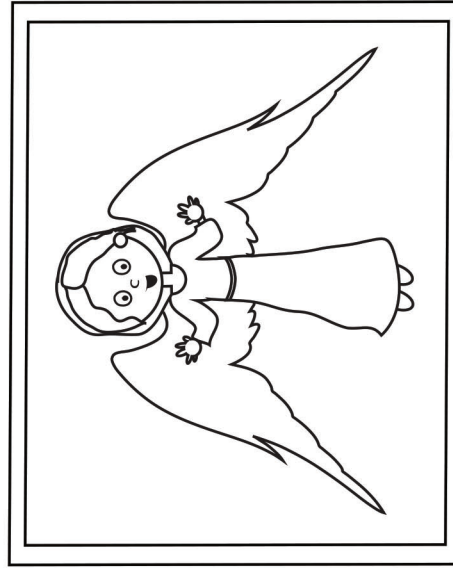

An Angel

Answer: The servant girl, jail, leaders and angel belong. The flower and the rug do not.

Deep Down Detective Devotion: Unit 15, Bible Truth 4, Lesson 3



Big Question 15 : How Can I Know What God Is Like?

Answer: To Worship God and Love One Another... By Telling What God Has Done and Praying!

Bible Truth 4 Meaning

When God's people gather together, they share with each other wonderful things God has done. They remind each other of the great things God did long ago in Bible times: how God always kept all His promises and did mighty things to save His people. They hear stories about how God has been at work around the world, bringing many other people to put their trust in Jesus as their Savior. They share with each other how God has been at work in their lives, caring for them and helping them live for Him. Oh, how faithful God has been to His people! Oh, how faithful God continues to be to them! All these stories of God's goodness and faithful helps them to keep on trusting God and living for Him. But God's people don't just talk to each other about what God has done. They also talk to God about them! All these stories of them. They praise and thank Him for what He has done. They confess ways they have disobeyed Him and seek His forgiveness. They ask Him to do more great things, in their lives and around the world. God delights in His people gathering together to pray. Jesus tells us in the Bible that when two or more of God's people are gathered together and praying that He will be there with them in a special way. Whether on their own or gathered together, God's people know God will always answer their prayers in the way He knows is best. We can become God's people, too, when we turn away from our sins and trust in Jesus as our Savior.

How do I know this is true? The Bible tells me so!

"Pray at all times in the Spirit with every prayer and request, and stay alert in this with all perseverance and intercession for all the saints."
--Ephesians 6:18, HCSB

Some Questions for You

1. Why was it getting so hard for the believers in Jerusalem? *Their enemies, and even King Herod, were trying to stop them. The king had taken James and had him killed. Then, he took Peter and put him in prison. He was probably planning to kill him, too.*
2. What did the king do to make sure that Peter did not escape? *He chained him between two soldiers in his jail room and then put two more soldiers outside the door as guards.*
3. What did the believers do while Peter was in jail? *They prayed and prayed that God would rescue him.*
4. How did God rescue Peter? *He sent an angel to him, who helped him out of the jail room, past the guards and through the big gates.*
5. What kinds of things can God's people today pray for? *For God to help His people love each other; to love and obey Him; to help others hear the good news of Jesus and be saved.... and many other things.*
6. How can we become God's people? *By turning away from our sins and trusting in Jesus as our Savior.*

Let's Pray!

- A** We praise You, God, for saving Your people, the Church. We praise You for Your faithfulness to Your people throughout all time.
- C** God, sometimes we don't want to hear about all the wonderful things You've done for Your people. Sometimes, we don't want to pray for You to do more. We just want to think about ourselves and do what we want to do. We need a Savior!
- T** God, thank You for Your Word, the Bible, that tells us about the great things You did for Your people who lived long ago. Thank You for all You do for Your people today, all around the world. Thank You for letting us hear of Your mighty works, and for using them to help us to keep trusting in You and living for You. Thank You for hearing our prayers to do even more.
- S** God, work in our hearts. Help us to turn away from our sins and trust in Jesus as our Savior that we might be Your people. Help us to love hearing about the mighty things You have done, long ago and today. Help us to praise You more because of what You have done. Help us to trust You and live for You. Help us to encourage others who gather together with us. In Jesus' name we pray, Amen.

Let's Praise God Right Now!

Big Q & A 15 Hymn: Brethren, We Have Met to Worship
from *Deep Down Detectives ESV Songs 15, track 15*

Verse 1

Brethren, we have met to worship,
And adore the Lord, our God.
Will you pray with all your power,
While we try to preach the Word?

Words: George Atkins Music: William Moore

Big Question 15 Praise Song: Praise the Lord Together
from *Deep Down Detectives ESV Songs 15, track 16*

Praise the Lord together saying:

"Hallelujah, Hallelujah, Hallelujah!"

Praise the Lord together saying:

"Hallelujah, Hallelujah, Hallelujah!" (repeat)

CAN YOU GUESS BIBLE TRUTH 5:
Why Do God's People Go to Church?
To Worship God and Love
One Another...

By Baptizing People Who Trust in
and Live for

----- !

HINT: What is the name of God's
Son? It starts with a "J" and it
rhymes with "sneezes."



Deep Down Detective Devotion: Unit 15, Bible Truth 5, Lesson 1



Big Question 15 : How Can I Know What God Is Like?

Answer: To Worship God and Love One Another... By Baptizing People Who Trust in and Live for Jesus!

Bible Truth 5 Meaning

Jesus told His disciples to baptize everyone who turns away from their sins and trusts in Him as their Savior. Baptism is a picture of the new life that begins when someone becomes a Christian. God has forgiven their sins and made them His people. God has filled their hearts with His Holy Spirit and made it new. They are leaving their old life behind and beginning a new life of living for Jesus. Not just anyone gets baptized. Baptism is a big deal. The godly leaders at church want to make sure that the person being baptized really understands the good news of Jesus and what it means to live as one of God's people. Sometimes a person is ready to be baptized very soon. But sometimes, the leaders think it's best if the person has more time to make sure that they really understand the good news of Jesus and are ready to live it out. It may not feel good to be told to wait, but the leaders want to do what's best for this person and what's best for the church. On baptism day, God's people gather together to watch, pray and celebrate. The person being baptized stands up and shares the story of how he came to trust in Jesus as his Savior. He tells of his desire to live God's way and to gather together with God's people. Then at last, it's baptism time! The new believer wades into the water with one of the pastors. The pastor holds onto the person as they lean back into the water for a few seconds. This is to remember that Jesus died and was buried for their sins. It's a picture that their old life of disobeying God is over. That life died with Jesus. Then, the pastor helps him/her come up out of the water. This reminds them that Jesus rose from the dead for them. He completely paid God's punishment for the sins. He has forgiven them once and for all. With God's help, they are beginning a new life of knowing, loving and obeying God. Often, everyone claps and cheers as the new believer comes up out of the water. They are so happy that someone else is telling the world that they are one of God's people and want to live for Him forever.

How do I know this is true? The Bible tells me so!

"Repent and be baptized every one of you in the name of Jesus Christ for the forgiveness of your sins." -- Acts 2:38, ESV

Some Questions for You

1. What happens when someone says sorry to God for their sins and trusts Jesus as their Savior? *God forgives them and saves them.*
2. What did Jesus tell people to do after they trust Him as their Savior? *Be baptized.*
3. What is going down in the water a picture of? *Remembering that Jesus died and was buried for their sins; and, that their old life of disobeying God is over.*
4. What is coming up out of the water a picture of? *Remembering that Jesus rose from the dead and beat death for them; and, that their new life as one of God's people has begun.*
5. Why do God's people like baptisms? *They get to hear the story how someone began a Christian; and, because they are happy that someone else has become one of God's people.*
6. What story do God's people tell before they are baptized? *They tell the story of how they heard the good news of Jesus and were saved.*
7. Why are some people asked to wait before they are baptized? *To give them more time to understand what it means to be a Christian and to make sure they are really ready to live for God. It is a very big deal to be baptized.*
8. How can we become God's people? *By turning away from our sins and trusting in Jesus as our Savior.*

Let's Pray!

- A** We praise You, God, for saving Your people, the Church, through Jesus. He is why we can become Your people.
- C** God, we know that we can never become Your people on our own. We have all turned away from You and Your good ways. We need a Savior!
- T** God, thank You for providing the way for us to become Your people through Jesus. Thank You for giving a new life to all who turn away from their sins and trust in Him. Thank You for giving us baptism to help us remember the new way of life You give to all who do this.
- S** God, work in our hearts. Help us to turn away from our sins and trust in Jesus as our Savior. Help us to one day be able to stand before God's people and tell the story of how You saved us. Help us to trust our leaders to know when we are ready to be baptized and when we need to still wait and grow. In Jesus' name we pray, Amen.

Let's Sing about What We're Learning!

Go to the [Deep Down Detectives Parent Resources for Unit 15](https://www.praisefactory.org) to get the Bible story and many more resources and songs for this unit at [praisefactory.org](https://www.praisefactory.org).

Big Q & A 15 Song from *Deep Down Detectives ESV Songs 15, track 12* (sung to the tune of "This Is the Way We Wash Our Clothes")

Why do God's people go to church?
Go to church? Go to church?
Why do God's people go to church?
To worship God and to love one another!

Big Question 15 Action Rhyme Song from *Deep Down Detectives ESV Songs 15, track 13*

Refrain:

Why do God's people go to church?
To worship God and love one another.
Why do God's people go to church?
To worship God and love one another.

Verse 1:

A church is God's people,
Gathered together.
It's not a building of bricks.
It's made up of people,
Who follow Jesus,
In faith and repentance.
Refrain

Verse 2

God's people gather to
worship God.
To sing His praises and pray.
They listen to preaching,
From God's Word, the Bible,
To better love Him each day.
Refrain

Verse 3

God's people gather to
love one another,
In acts of kindness and grace.
They love one another,
Like sisters and brothers,
Helping all to live God's way.
Refrain



**“Repent and be baptized every one of you in the name of Jesus Christ
for the forgiveness of your sins.” -- Acts 2:38, ESV**

Deep Down Detective Devotion: Unit 15, Bible Truth 5, Lesson 2



Big Question 15: Why Do God's People Go to Church?

Answer: To Worship God and Love One Another... By Baptizing People Who Trust in and Live for Jes

How do I know this is true? The Bible tells me so!

"Repent and be baptized every one of you in the name of Jesus Christ for the forgiveness of your sins." -- Acts 2:38, ESV

Learn a Little: "Repent and be baptized in the name of Jesus Christ."

Meaning

What a wonderful gift God has given us in Jesus! Through Him, we can be forgiven our sins and can become God's people forever. What do we have to do to receive this gift? Repent of our sins (that is, turning away from wanting to disobey God and live for Him instead) and trust in Jesus as our Savior. God promises to save all who come to Him like this! And what happens when someone does this? God hears his prayers and forgives him. God puts His Holy Spirit in their heart and they begin a whole new life with God. God wants all who repent and believe in Jesus to be baptized as a special sign to everyone of what has happened inside their heart. Their old way of living is gone. They are forgiven! They are saved! And now they belong to God and live for Him! Have you ever been to a baptism? We can become one of God's people, too, when we turn away from our sins and trust in Jesus as our Savior.

Some Questions for You

1. What does "repent" mean? *It means to turn away from your sins.*
2. Who do God's people trust in as their Savior? *Jesus.*
3. What does God do when repent of our sins and trust in Jesus as our Savior? *He forgives our sins and makes us His people.*
4. What did Jesus want God's people to do to show everyone that they were beginning to live a new life for God? *To be baptized.*
5. What happens when someone is baptized? *They stand up before the church and tell how they turned from their sins and trusted in Jesus as their Savior. They promise to live a new life for God. They go down in the water with the pastor. He gently puts them in the water, then brings them back up. It is a sign that their old life is gone. Now they are living a new life for God.*
6. How can we become one of God's people? *By turning away from our sins and trusting in Jesus as our Savior.*

Let's Pray!

- A** We praise You, God, for saving Your people, the Church, through Jesus. He is why we can become Your people.
- C** God, we know that we can never become Your people on our own. We have all turned away from You and Your good ways. We need a Savior!
- T** God, thank You for providing the way for us to become Your people through Jesus. Thank You for giving a new life to all who turn away from their sins and trust in Him. Thank You for giving us baptism to help us remember the new way of life You give to all who do this.
- S** God, work in our hearts. Help us to turn away from our sins and trust in Jesus as our Savior. Help us to one day be able to stand before God's people and tell the story of how You saved us. Help us to trust our leaders to know when we are ready to be baptized and when we need to still wait and grow. In Jesus' name we pray, Amen.

Let's Sing Our Bible Verse!

Repent, Repent and Be Baptized: Acts 2:38-39, ESV from *Deep Down Detectives* ESV Songs 15, track 46

Repent, repent and be baptized,
Ev'ry one of you,
In the name of Jesus Christ,
For forgiveness of your sins.
You will receive the Holy Spirit, the promise is for all,
For all the Lord our God calls,
For all the Lord calls.
Acts Two, thirty-eight and nine.

Go to the *Deep Down Detectives* Parent Resources for Unit 15 to get the Bible story and many more resources and songs for this unit at praisefactory.org

DDD BQ 15 BT 5 L2 Coloring Sheet/Take Home pg2

Which four of these clues belong in our story? Which two do not? Put an X in the boxes of the four that belong.

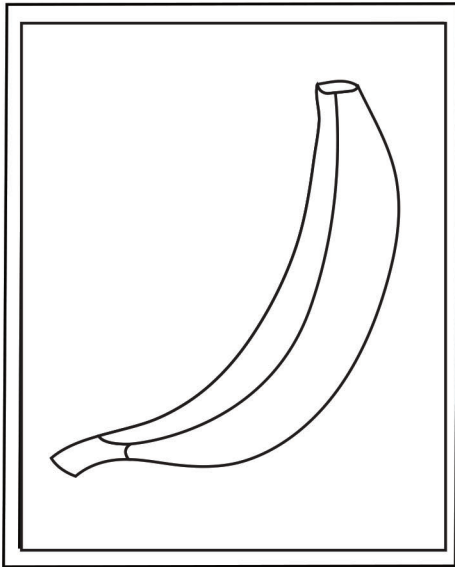

A Banana

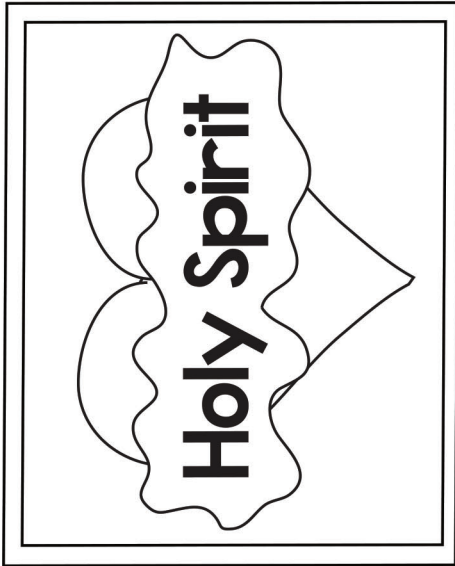

The Holy Spirit in a Heart

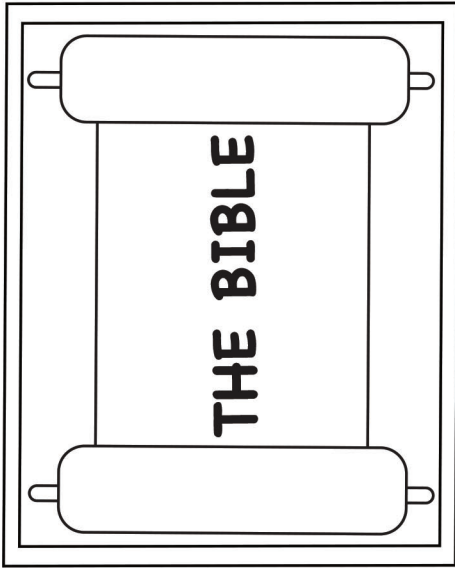

The Bible

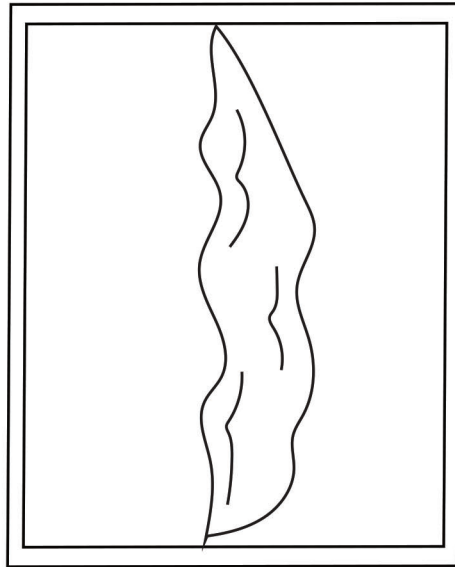

Water

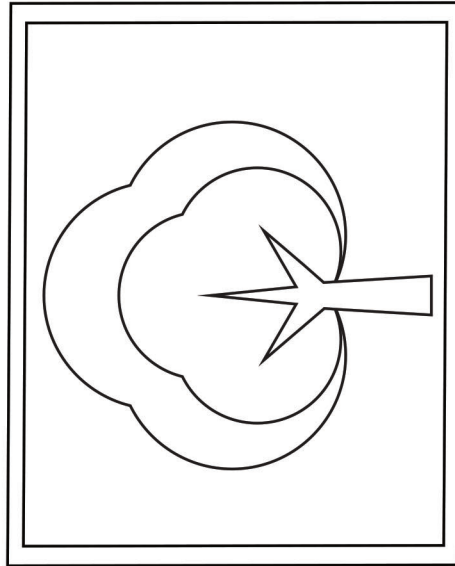

A Tree

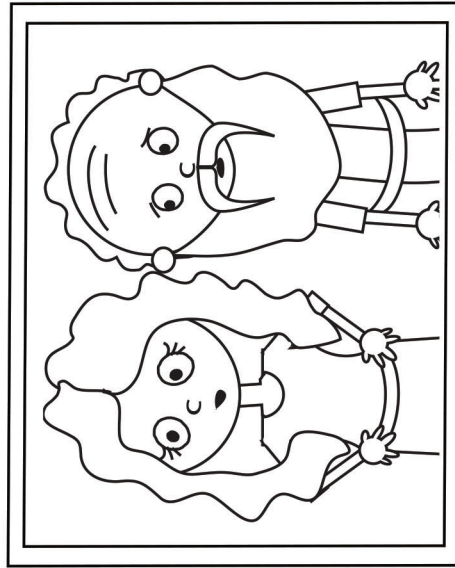

Listeners

Deep Down Detective Devotion: Unit 15, Bible Truth 5, Lesson 3



Big Question 15 : How Can I Know What God Is Like?

Answer: To Worship God and Love One Another... By Baptizing People Who Trust in and Live for Jesus!

Bible Truth 5 Meaning

Jesus told His disciples to baptize everyone who turns away from their sins and trusts in Him as their Savior. Baptism is a picture of the new life that begins when someone becomes a Christian. God has forgiven their sins and made them His people. God has filled their hearts with His Holy Spirit and made it new. They are leaving their old life behind and beginning a new life of living for Jesus. Not just anyone gets baptized. Baptism is a big deal. The godly leaders at church want to make sure that the person being baptized really understands the good news of Jesus and what it means to live as one of God's people. Sometimes a person is ready to be baptized very soon. But sometimes, the leaders think it's best if the person has more time to make sure that they really understand the good news of Jesus and are ready to live it out. It may not feel good to be told to wait, but the leaders want to do what's best for this person and what's best for the church. On baptism day, God's people gather together to watch, pray and celebrate. The person being baptized stands up and shares the story of how he came to trust in Jesus as his Savior. He tells of his desire to live God's way and to gather together with God's people. Then at last, it's baptism time! The new believer wades into the water with one of the pastors. The pastor holds onto the person as they lean back into the water for a few seconds. This is to remember that Jesus died and was buried for their sins. It's a picture that their old life of disobeying God is over. That life died with Jesus. Then, the pastor helps him/her come up out of the water. This reminds them that Jesus rose from the dead for them. He completely paid God's punishment for the sins. He has forgiven them once and for all. With God's help, they are beginning a new life of knowing, loving and obeying God. Often, everyone claps and cheers as the new believer comes up out of the water. They are so happy that someone else is telling the world that they are one of God's people and want to live for Him forever.

How do I know this is true? The Bible tells me so!

"Repent and be baptized every one of you in the name of Jesus Christ for the forgiveness of your sins." -- Acts 2:38, ESV

Some Questions for You

1. What did Jesus tell his disciples to do before He went up to heaven? *To wait, then go.*
2. What were they supposed to wait for? *For the Holy Spirit to come and live inside their hearts. He would give them the power and wisdom and courage to do everything Jesus told them to do.*
3. Where were they supposed to go? *To all parts of the world, telling people the good news of Jesus and teaching them how to live as God's people. They were to baptize the people who did this, showing that they had turned away from their old life and had begun a new life as God's dearly loved people.*
4. Who did they baptize? *Those who had turned away from their sins and trusted in Jesus as their Savior.*
5. What new life did the believers promise to live with the help of God's Holy Spirit? *A life lived out for God.*
6. Where did the disciples go? *They started in their own city, Jerusalem; then, they went to the land of their enemies who lived next to them; then, they went to other faraway places. Everywhere they went, they told the good news of Jesus, taught people how to live as God's people and baptized all who turned away from their sins and trusted in Jesus as their Savior.*
7. How can we become God's people? *By turning away from our sins and trusting in Jesus as our Savior. And if we do, there will come a special day when we are baptized, too!*

Let's Pray!

- A** We praise You, God, for saving Your people, the Church, through Jesus. He is why we can become Your people.
- C** God, we know that we can never become Your people on our own. We have all turned away from You and Your good ways. We need a Savior!
- T** God, thank You for providing the way for us to become Your people through Jesus. Thank You for giving a new life to all who turn away from their sins and trust in Him. Thank You for giving us baptism to help us remember the new way of life You give to all who do this.
- S** God, work in our hearts. Help us to turn away from our sins and trust in Jesus as our Savior. Help us to one day be able to stand before God's people and tell the story of how You saved us. Help us to trust our leaders to know when we are ready to be baptized and when we need to still wait and grow. In Jesus' name we pray, Amen.

Let's Praise God Right Now!

Big Q & A 15 Hymn: Brethren, We Have Met to Worship
from Deep Down Detectives ESV Songs 15, track 15

Verse 1

Brethren, we have met to worship,
And adore the Lord, our God.
Will you pray with all your power,
While we try to preach the Word?

Words: George Atkins Music: William Moore

Big Question 15 Praise Song: Praise the Lord Together
from Deep Down Detectives ESV Songs 15, track 16

Praise the Lord together saying:
"Hallelujah, Hallelujah, Hallelujah!"
Praise the Lord together saying:
"Hallelujah, Hallelujah, Hallelujah!" (repeat)

Go to the Deep Down Detectives Parent Resources for Unit 15 to get the Bible story and many more resources and songs for this unit at praisefactory.org

DDD BQ 15 BT 3 L3 Coloring Sheet/Take Home pg2

CAN YOU GUESS BIBLE TRUTH 6:
Why Do God's People Go to Church?
To Worship God and Love
One Another...

By Remembering Jesus

to Save Them!

HINT: What is the opposite of "lived?"
It starts with an "D" and it rhymes
with "fried"?

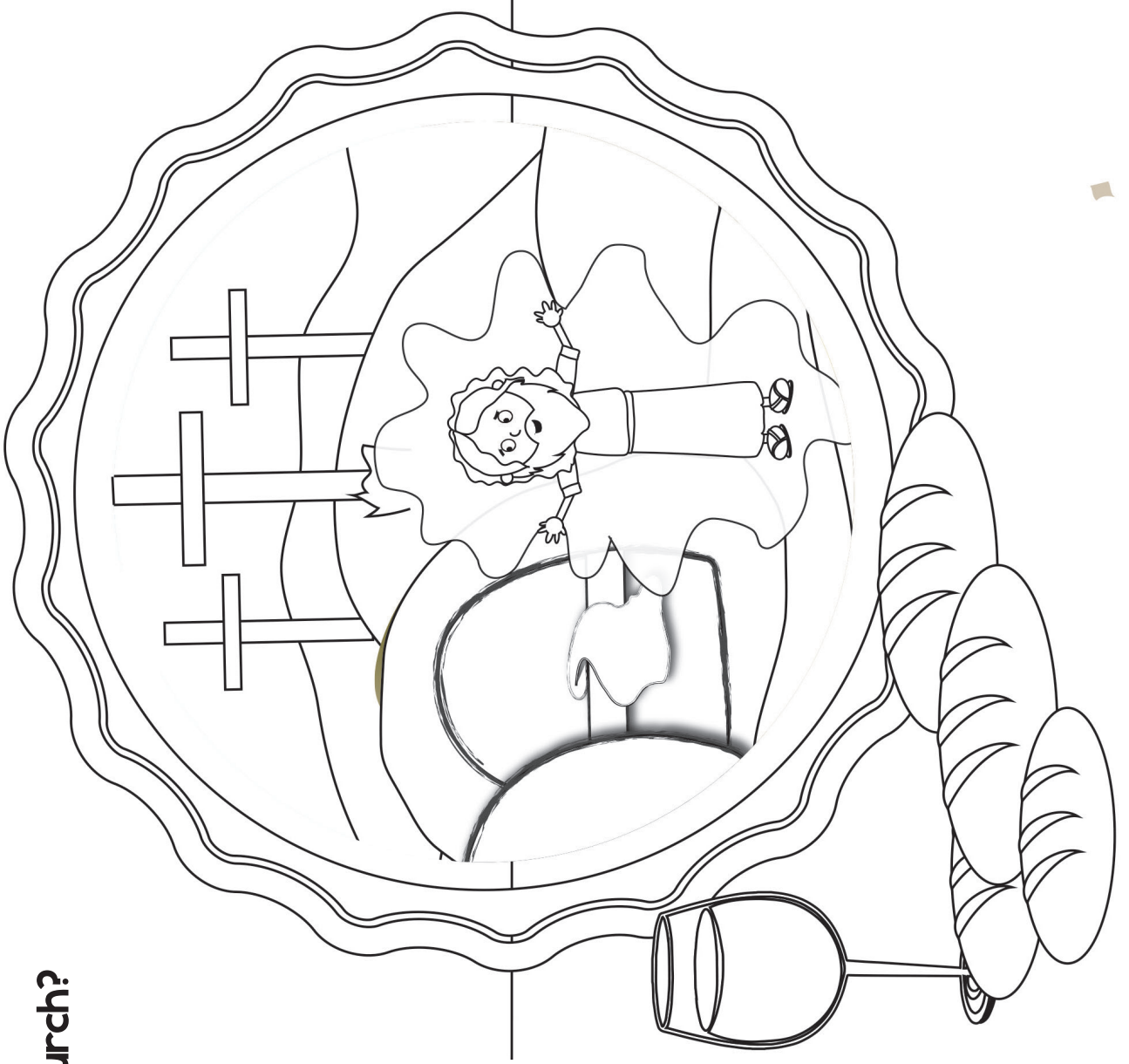

Deep Down Detective Devotion: Unit 15, Bible Truth 6, Lesson 1



Big Question 15 : How Can I Know What God Is Like?

Answer: To Worship God and Love One Another... By Caring for Each Other's Needs!

Bible Truth 6 Meaning

When God's people gather together, they remember how Jesus died to save them. They do this with a special meal called "the Lord's Supper." It's called this because Jesus shared it with His own special followers on the night before He died on the cross. There are only two, little pieces of food eaten at the Lord's Supper: a little piece of bread and a little grape juice or wine. That's because it's not really about eating a whole, big meal. It's about remembering what Jesus did for God's people when He died on the cross. The bread stands for Jesus' body, that He offered up for the sins of God's people. He took in His body, the punishment they deserved from God for their sins. He did this so they would never have to know that punishment themselves. The grape juice or wine stands for Jesus' blood shed when He died on the cross. Blood was a part of every big, covenant promise. It reminded everyone that this promise must be kept, no matter what. Jesus said the juice/wine was to remind God's people of His blood given to make a new covenant/forever promise with God. It meant that no matter what, His payment for their sins was enough. They would always be forgiven. They would always be God's people, having special closeness with Him now. And one day, living with Him forever. When God's people take the Lord's Supper, it is a very special time. People are usually very quiet. Many think about the ways they have disobeyed God and ask for His forgiveness. Many thank God for sending Jesus to save them. Jesus told God's people that they were to keep on celebrating this special meal until He comes back at the end of time. Only God's people who repent of their sins, trust in Jesus as their Savior, and are baptized should take the Lord's Supper. We can become God's people, too, when we repent of our sins and trust in Jesus as our Savior.

How do I know this is true? The Bible tells me so!

"This is my body, which is given for you. Do this in remembrance of me." And likewise the cup after they had eaten, saying, "This cup that is poured out for you is the new covenant in my blood." -- Luke 22:19,20, ESV

Some Questions for You

1. What is the name of the special meal God's people take to remember Jesus' death? *The Lord's Supper.*
2. Why is the Lord's Supper called that? *Because it was the special meal that Jesus ate with His special followers right before He died.*
3. What does the little piece of bread stand for? *Jesus' body given for His people on the cross.*
4. What does the little bit of juice/wine stand for? *Jesus' blood poured out to make the forever promise with God to save them.*
5. What do God's people think about when they take the Lord's Supper? *How they have disobeyed God. How thankful they are that Jesus died to save them.*
6. How long did Jesus tell God's people to take the Lord's Supper? *Until He comes back.*
7. Who is to take the Lord's Supper? *God's people when they gather together as a church. Your parents and the godly leaders who lead your church can help you know if you are ready to take it.*
8. How can we become God's people? *By turning away from our sins and trusting in Jesus as our Savior.*

Let's Pray!

- A** We praise You, God, for being the Savior of Your people, the Church.
- C** God, this special meal reminds us of what Jesus did to save sinners like us. We know that we have all chosen to live life our own way. We have all chosen not to love You or obey Your good ways. We need a Savior! You are our only hope.
- T** God, thank You for sending Jesus to be our Savior. Thank You for His body, given to pay for the sins of all who trust in Him as their Savior. Thank You for His blood, given as the promise that those who turn away from their sins and trust in Jesus are Your people forever.
- S** God, work in our hearts. Help us to turn away from our sins and trust in Jesus as our Savior. Make us Your people. Use this special meal to remind us of what Jesus has done. In Jesus' name we pray, Amen.

Let's Sing about What We're Learning!

Go to the *Deep Down Detectives Parent Resources for Unit 15* to get the Bible story and many more resources and songs for this unit at praisefactory.org

Big Q & A 15 Song from *Deep Down Detectives ESV Songs 15, track 12* (sung to the tune of "This Is the Way We Wash Our Clothes")

Why do God's people go to church?
Go to church? Go to church?
Why do God's people go to church?
To worship God and to love one another!

Big Question 15 Action Rhyme Song from *Deep Down Detectives ESV Songs 15, track 13*

Refrain:
Why do God's people go to church?
To worship God and love one another.
Why do God's people go to church?
To worship God and love one another.

Verse 1:
A church is God's people,
Gathered together.
It's not a building of bricks.
It's made up of people,
Who follow Jesus,
In faith and repentance.
Refrain

Verse 2
God's people gather to
worship God.
To sing His praises and pray.
They listen to preaching,
From God's Word, the Bible,
To better love Him each day.
Refrain

Verse 3
God's people gather to
love one another,
In acts of kindness and grace.
They love one another,
Like sisters and brothers,
Helping all to live God's way.
Refrain

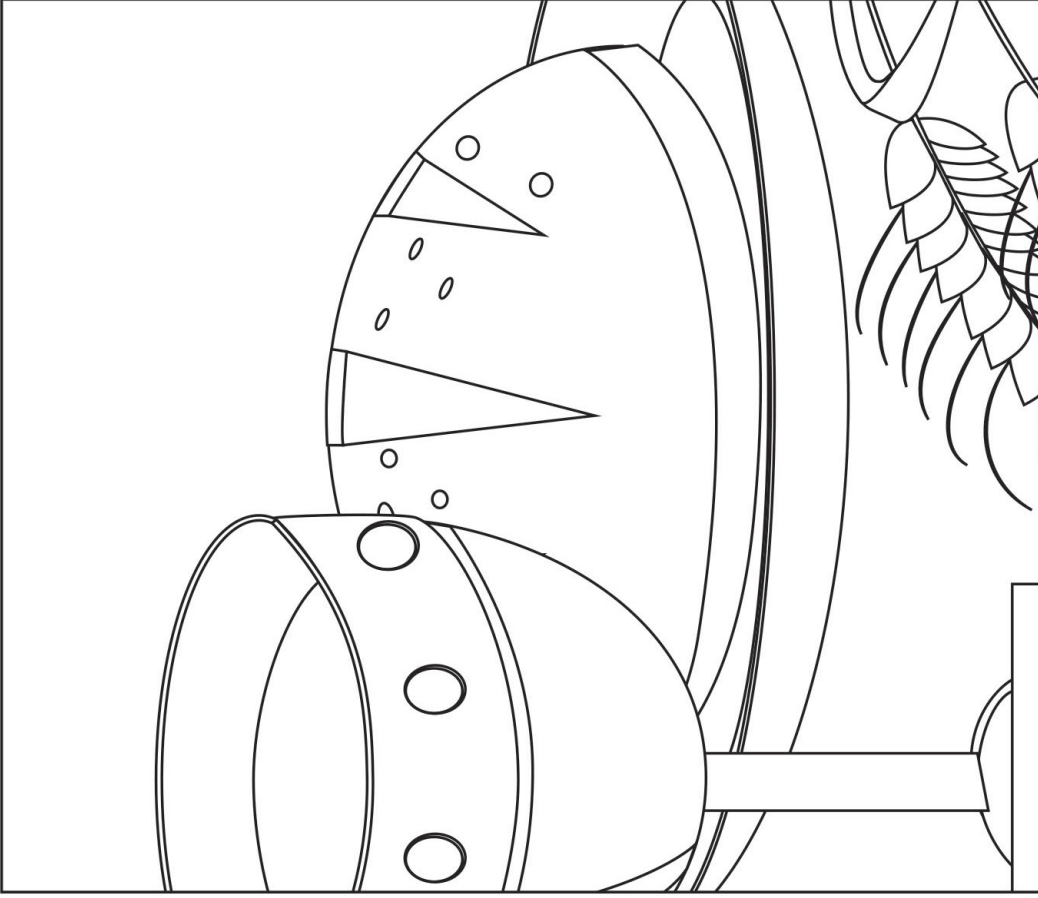
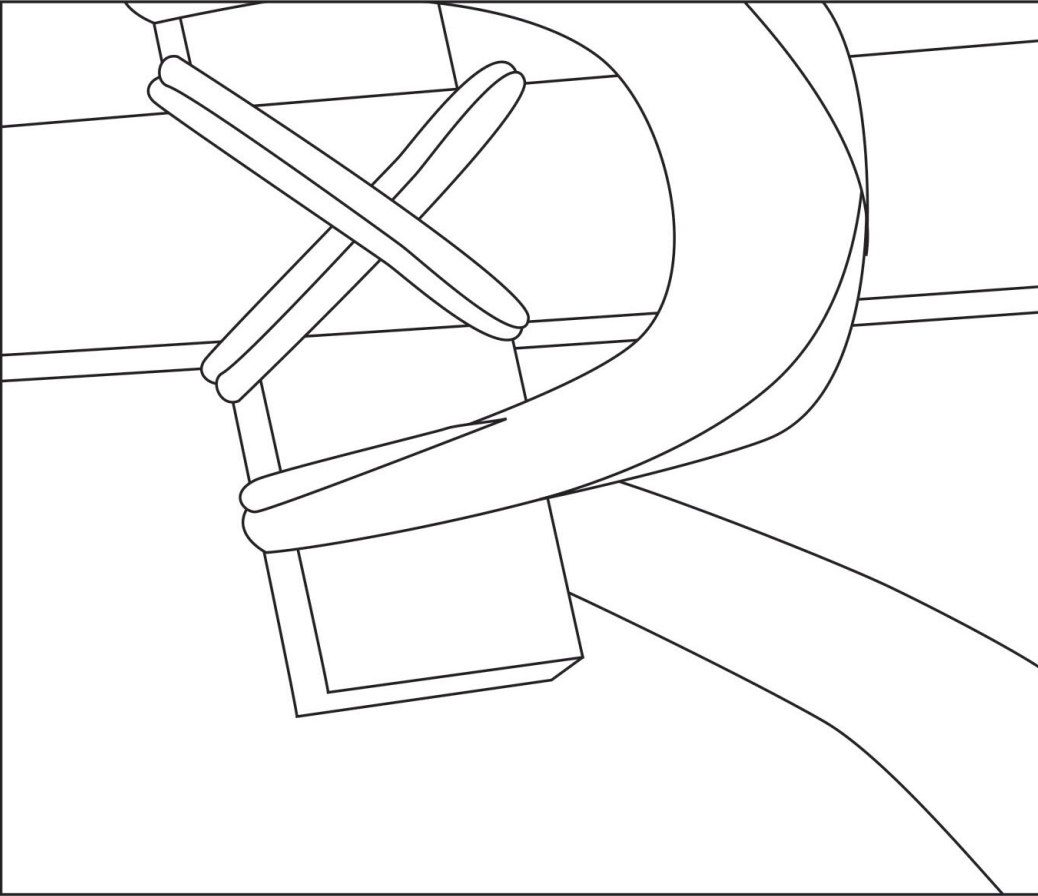

**“This is my body, which is given for you. Do this in remembrance of me.”
And likewise the cup after they had eaten, saying, “This cup that is poured
out for you is the new covenant in my blood.” -- Luke 22:19,20, ESV**

Deep Down Detective Devotion: Unit 15, Bible Truth 6, Lesson 2



Big Question 15: Why Do God's People Go to Church?

Answer: Hes Not Like Anyone Else... By Remembering Jesus Died to Save Them!

How do I know this is true? The Bible tells me so!

"This is my body, which is given for you. Do this in remembrance of me." And likewise the cup after they had eaten, saying, "This cup that is poured out for you is the new covenant in my blood." -- Luke 22:19,20, ESV

Learn a Little: "This is my body, which is given for you. Do this in remembrance of me."

Meaning:

When God's people gather together at church, they remember how Jesus died on the cross to save them. They remember that He let His body be hurt and His blood be spilled out as He suffered and died for their sins. How do they do this? The way Jesus told His disciples to: with a special little meal of bread and wine or grape juice. The bread is eaten as a way to remember how His body for broken on the cross for their sins. The wine or grape juice is drunk as a way to remember that it was His blood that paid for their sins so they could be forgiven by God. God's people have this special meal often, just like Jesus told them to. How thankful they are for Jesus and all He did for them! We can become God's people when we turn away from our sins and trust in Jesus as our Savior.

Some Questions for You

1. Who died to save God's people from their sins? *Jesus did.*
2. What did Jesus tell God's people to do to remember how He died for them? *To eat the Lord's Supper.*
3. What food and drink are used at the Lord's Supper? *Little pieces of bread and grape juice/wine.*
4. Of what does the bread remind God's people? *Of Jesus' body. He chose to suffer and die on the cross for them.*
5. Of what does the grape juice/wine remind God's people? *Of Jesus' blood that was the perfect payment for the sins of God's people.*
6. Who should take the Lord's Supper? *Only God's people.*
7. How can we become God's people? *By turning away from our sins and trusting in Jesus as our Savior.*

Let's Pray!

- A** We praise You, God, for being the Savior of Your people, the Church.
- C** God, this special meal reminds us of what Jesus did to save sinners like us. We know that we have all chosen to live life our own way. We have all chosen not to love You or obey Your good ways. We need a Savior! You are our only hope.
- T** God, thank You for sending Jesus to be our Savior. Thank You for His body, given to pay for the sins of all who trust in Him as their Savior. Thank You for His blood, given as the promise that those who turn away from their sins and trust in Jesus are Your people forever.
- S** God, work in our hearts. Help us to turn away from our sins and trust in Jesus as our Savior. Make us Your people. Use this special meal to remind us of what Jesus has done. In Jesus' name we pray, Amen.

Let's Sing Our Bible Verse!

This Is My Body: Luke 22:19,20, ESV from *Deep Down Detectives* ESV Songs 15, track 49

This is my body, given for you,
This is my blood, which is poured out for you.
Do this, do this in remembrance of me,
Do this in remembrance of me.
Luke Twenty-two, nineteen and twenty.

Go to the *Deep Down Detectives* Parent Resources for Unit 15 to get the Bible story and many more resources and songs for this unit at praisefactory.org

Which four of these clues belong in our story? Which two do not? Put an X in the boxes of the four that belong.

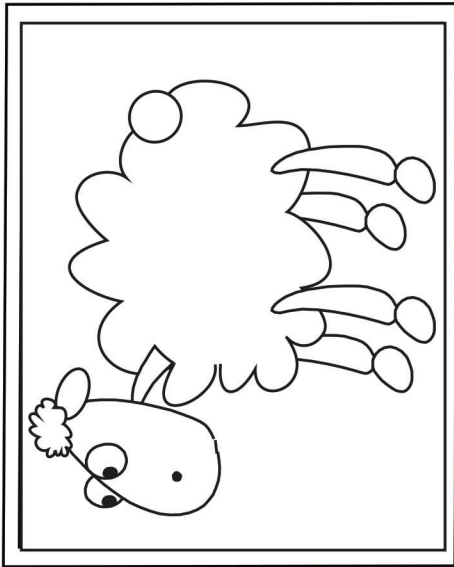

A Lamb

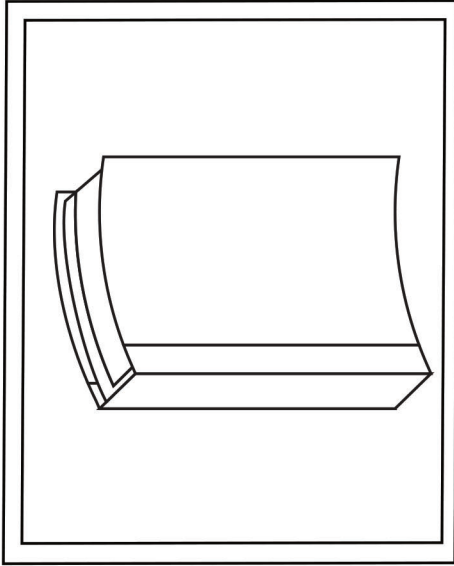

A Book

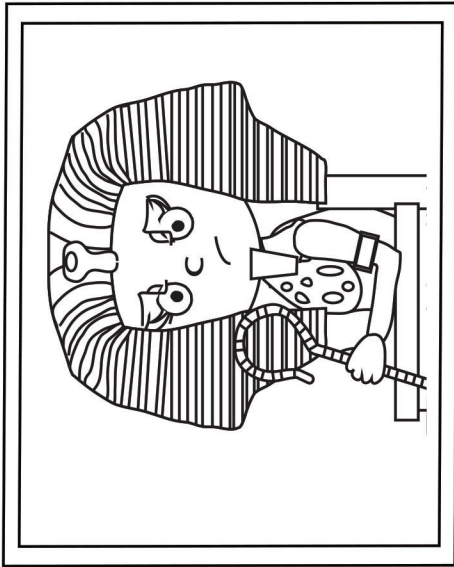

Pharaoh, King of Egypt

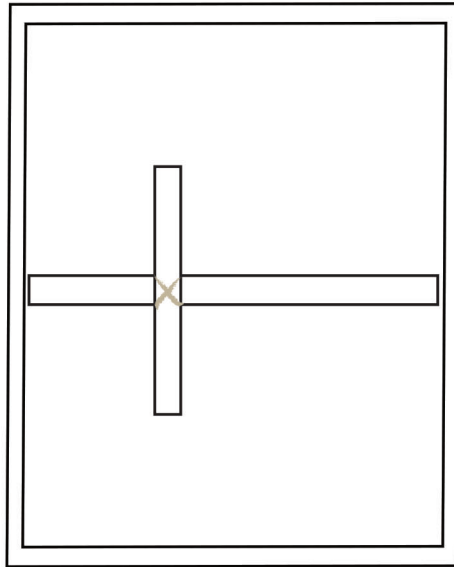

A Cross

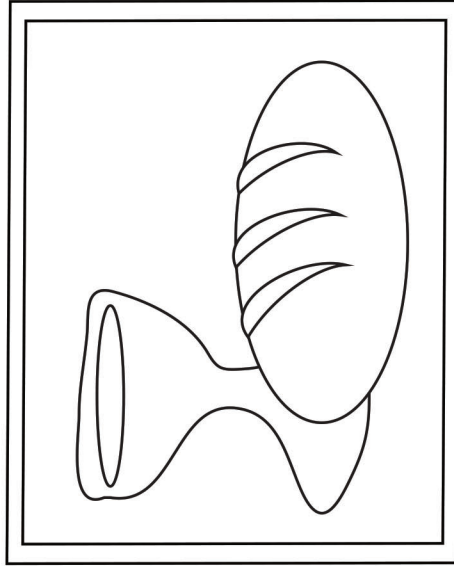

TA Little Meal

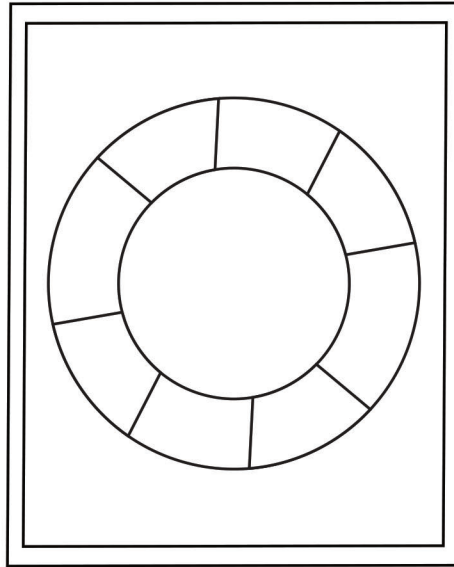

A Life Preserver

Answer: The lamb, Pharaoh, the cross and the little meal belong. The book and the life preserver do not.

Deep Down Detective Devotion: Unit 15, Bible Truth 6, Lesson 3



Big Question 15 : How Can I Know What God Is Like?

Answer: To Worship God and Love One Another... By Caring for Each Other's Needs!

Bible Truth 6 Meaning

When God's people gather together, they remember how Jesus died to save them. They do this with a special meal called "the Lord's Supper." It's called this because Jesus shared it with His own special followers on the night before He died on the cross. There are only two, little pieces of food eaten at the Lord's Supper: a little piece of bread and a little grape juice or wine. That's because it's not really about eating a whole, big meal. It's about remembering what Jesus did for God's people when He died on the cross. The bread stands for Jesus' body, that He offered up for the sins of God's people. He took in His body, the punishment they deserved from God for their sins. He did this so they would never have to know that punishment themselves. The grape juice or wine stands for Jesus' blood shed when He died on the cross. Blood was a part of every big, covenant promise. It reminded everyone that this promise must be kept, no matter what. Jesus said the juice/wine was to remind God's people of His blood given to make a new covenant/forever promise with God. It meant that no matter what, His payment for their sins was enough. They would always be forgiven. They would always be God's people, having special closeness with Him now. And one day, living with Him forever. When God's people take the Lord's Supper, it is a very special time. People are usually very quiet. Many think about the ways they have disobeyed God and ask for His forgiveness. Many thank God for sending Jesus to save them. Jesus told God's people that they were to keep on celebrating this special meal until He comes back at the end of time. Only God's people who repent of their sins, trust in Jesus as their Savior, and are baptized should take the Lord's Supper. We can become God's people, too, when we repent of our sins and trust in Jesus as our Savior.

How do I know this is true? The Bible tells me so!

"This is my body, which is given for you. Do this in remembrance of me." And likewise the cup after they had eaten, saying, "This cup that is poured out for you is the new covenant in my blood." -- Luke 22:19,20, ESV

Some Questions for You

1. What did the people of Israel gather together every year to celebrate? *How God had rescued them from their strong enemies, the Egyptians, long ago.*
2. What did the Egyptians do to the Israelites? *They forced them to work for them and wouldn't let them go.*
3. What did God do to rescue the people of Israel? *Many amazing things.*
4. What did God tell the people of Israel to do on the night before He was going to free them? *To take the blood of a lamb and put it on the door of their house. To cook their bread flat. To pack up and get ready to go. They were to eat the lamb and eat the bread at dinner and celebrate what God would do for them.*
5. What was the even greater thing that the LORD did for His people? *He sent Jesus to be their Savior.*
6. What did Jesus do at the Passover dinner? *He shared with His close friends, the disciples, that told them what He was about to do? He told them that they were now to remember His body when they ate the flat bread. He was going to give it up for them on the cross. They were now to remember His blood when they drank the Passover wine. He was going to shed His blood on the cross to make a new promise with God to save His people from their sins. His blood would be the perfect payment needed.*
7. Why do people at your church still celebrate the Lord's Supper? *Because Jesus told us that God's people should keep on remembering Him this way until He comes back.*
8. How can we become God's people? *By turning from our sins and trusting in Jesus as our Savior. If we do, one day we will get to take the Lord's Supper with the believers at our church, too.*

Let's Pray!

- A** We praise You, God, for being the Savior of Your people, the Church.
- C** God, this special meal reminds us of what Jesus did to save sinners like us. We know that we have all chosen to live life our own way. We have all chosen not to love You or obey Your good ways. We need a Savior! You are our only hope.
- T** God, thank You for sending Jesus to be our Savior. Thank You for His body, given to pay for the sins of all who trust in Him as their Savior. Thank You for His blood, given as the promise that those who turn away from their sins and trust in Jesus are Your people forever.
- S** God, work in our hearts. Help us to turn away from our sins and trust in Jesus as our Savior. Make us Your people. Use this special meal to remind us of what Jesus has done. In Jesus' name we pray, Amen.

Let's Praise God Right Now!

Big Q & A 15 Hymn: Brethren, We Have Met to Worship
from *Deep Down Detectives ESV Songs 15, track 15*

Verse 1

Brethren, we have met to worship,
And adore the Lord, our God.
Will you pray with all your power,
While we try to preach the Word?

Words: George Atkins Music: William Moore

Big Question 15 Praise Song: Praise the Lord Together
from *Deep Down Detectives ESV Songs 15, track 16*

Praise the Lord together saying:

"Hallelujah, Hallelujah, Hallelujah!"

Praise the Lord together saying:

"Hallelujah, Hallelujah, Hallelujah!" (repeat)

Go to the *Deep Down Detectives Parent Resources for Unit 15* to get the Bible story and many more resources and songs for this unit at praisefactory.org

DDD BQ 15 BT 3 L3 Coloring Sheet/Take Home pg2