

DEEP DOWN DETECTIVES



Unit 11

Simple Story Scenes, ESV

The God Who Saves



Curriculum for preschool and elementary age children,
training tools, music and other resources
are available for download or to order at:
www.praisefactory.org

© 2023 Praise Factory Media all rights reserved. May be reproduced by licensed user for classroom purposes only.

This and many other resources are available online at www.praisefactory.org

Scripture quotations marked (NIV) are taken from the Holy Bible, New International Version®, NIV®, Copyright © 1973, 1978, 1984 by Biblica, Inc.™ Used by permission of Zondervan. All rights reserved worldwide.www.zondervan.com

Scripture quotations marked (ESV) are from The Holy Bible, English Standard Version® (ESV®), copyright © 2001 by Crossway, a publishing ministry of Good News Publishers. Used by permission. All rights reserved.

Scripture quotations marked HCSB are taken from the Holman Christian Standard Bible®, Copyright © 1999, 2000, 2002, 2003, 2009 by Holman Bible Publishers. Used by permission. Holman Christian Standard Bible®, Holman CSB®, and HCSB® are federally registered trademarks of Holman Bible Publishers.

Table of Contents

About the Deep Down Detectives Visual Aids	5
Unit 11: The God Who Saves	
How Can We Be Saved? It Is God's Free Gift!	
Bible Truth 1: When We Tell God Our Sins and Turn Away from Them	9
Bible Truth 1 Overview	11
Story Scenes	13
Bible Truth 2: When We Trust in Jesus as Our Own Savior	71
Bible Truth 2 Overview	73
Story Scenes	75
Bible Truth 3: When the Holy Spirit Works in Our Hearts	127
Bible Truth 3 Overview	129
Story Scenes	131
Take-Home Sheets	183
Bible Truth 1	185
Bible Truth 2	191
Bible Truth 3	197

Deep Down Detectives Curriculum Resources

There are five companion resources for each of the sixteen units of Deep Down Detectives. Use whichever resources are useful to your setting. Deep Down Detectives resources are available as free, digital downloads at praisefactory.org, or for purchase as hard copies through amazon.com.

Make sure to check out the “Bits and Pieces” section of the Deep Down Detectives curriculum online. It has all of the resources separated out making it easy for you simply to pick, choose and print out whatever you want.

Deep Down Detectives Core Curriculum Book, ESV/NIV for each unit

The Deep Down Detectives Core Curriculum book contains the curriculum introduction, the lesson plans, stories, music, activities and take home sheets for each of the units.

Deep Down Detectives Visual Aids with Simple Story Scenes, ESV/NIV for each unit

This resource provides large, colorful signs of the key concepts used in the unit, PLUS, easy-to-use, colorful scenes that you hold up in sequence as you tell the story. The story text for each scene is printed on the bottom of each scene.

Deep Down Detectives Simple Story Scenes, ESV/NIV for each volume

This resource includes only 2-page overview for Bible Truth, the story scenes, and take home sheets. This is a great, basic resource for use at home and in many classroom teaching situations.

Deep Down Detectives Small Format Visual Aids, ESV/NIV (Small Format Storyboard Pictures) for each volume

This resource provides large, colorful signs of the key concepts used in the unit, PLUS, colorful storyboard (flannelgraph) pictures to cut out and use as you tell each story. These storyboard pictures are for use with storyboards at least 24" x 36" in size.

Deep Down Detectives Large Format Visual Aids, ESV/NIV (Large Format Storyboard Pictures) for each volume

This resource provides large, colorful signs of the key concepts used in the unit. It also provides colorful storyboard (flannelgraph) pictures to cut out and use as you tell each story. These storyboard pictures are for use with storyboards 36" x 48" in size.

All of these materials may be photocopied for non-commercial church, classroom or school use by licensed users.

Other Resources in the Praise Factory Family of Curriculum

Deep Down Detectives is the second in a family of three, inter-related curriculums:

- Hide 'n' Seek Kids (focus group: ages 2-4; adaptable range: ages 2-pre-K 5's)
- Deep Down Detectives (focus group: ages 4--6's; adaptable range: ages 3-2nd grade)
- PFI: (focus group: grades K-5th grade; adaptable range: pre-K 5's-6th grade)

Each curriculum teaches the same biblical themes, but are presented in greater depth as the children grow and develop. Together, the curriculums work like an expanding spiral of truth that returns to reinforce the same truths with each curriculum, yet leading the children to deeper understanding with each step up.

Learn more about these curriculums as well as other resources and ideas for reaching children with the gospel at: www.praisefactory.org.

About the Deep Down Detectives Visual Aids

How Are They Used?



The Deep Down Detectives Visual Aids book is a companion resource to be used alongside the Deep Down Detectives Core Curriculum book for each unit. These colorful pictures are used in presenting the key concepts; telling the Bible stories; and, in playing the Bible Story Review games.

What Do They Include?



There are four, different resources included in this book:

1. Key Concept Visual Aids-- colorful signs of the Big Question and Answer, the Bible Truth, the Bible verse, and the Listening Assignments to use with the 3 lessons for each Bible Truth.

2. The Story Scenes. Notice that each scene is numbered and that there is a brief summary of the story that corresponds to the picture. You can actually just tell the story in a simple way by using only the text at the bottom of each Story Scene.

3. Take-Home Sheets for each Bible Truth.

4. Directions for making the Deep Down Detectives "Bible" Folder and the **back/front images** to paste in place when making it. (Larger back/front images are found online with the curriculum.)

Directions for how to make a homemade flannelgraph storyboard and sturdy Story Scene pictures are found in the back of this book.

Ready, Set, Rip It Out!

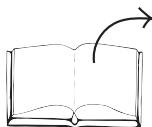

This book is meant to be ripped up and made into your visual aids. The key concept signs can be cut out and laminated or slipped into sheet protectors. The Story Scenes can be put in sheet protectors or laminated, too.

Store It!



Deep Down Detectives is a curriculum that can be used over and over. Store your visual aids and storyboard pictures after using them and they will serve you for many years. We store ours in manilla envelopes and then put them (along with all the rest of the curriculum) in magazine files, labelled by Bible Truth. If you have multiple classes using the curriculum, store each set of resources in separate manilla envelopes. This will make prep much simpler, second time around.

Replacement Story Scene Pictures



You can always purchase this book again or simply go online and print out any scenes that go missing.

Other Options

You can also choose to tell the story in a more traditional flannelgraph way by using your own flannelgraph figures or by purchasing/free downloading the Storyboard Pictures (large and small format size available). This is more complex and requires more preparation, but some love it. And, it does allow for kids to interact more by helping to place pictures up on the board as you tell the story.

Unit 11: The God Who Saves

UNIT OVERVIEW

We all have disobeyed God. We have all lost the wonderful special closeness with God that He meant for us to have with Him. No matter how hard we try, we can't ever be good enough to win back special closeness with God. No, we can't save ourselves, but God can. That's why He sent Jesus: to save us as a free gift from Him. Anyone who turns away from their sins and trusts in Jesus as their Savior, will receive His forgiveness. They will become His people, who know Him in their hearts by His Holy Spirit. And one day, God will take them to live with Him forever. This is the free gift God offers to you and me. God is so kind to us!

In this unit we will learn three truths about this wonderful, free gift God offers us.

UNIT BIBLE VERSE: Romans 6:23, ESV

"For the wages of sin is death, but the free gift of God is eternal life in Christ Jesus our Lord."

BIG QUESTION UNDER INVESTIGATION: How Can We Be Saved?

ANSWER: It Is God's Free Gift!

OPTIONAL Big Question 11 INTRODUCTION LESSON (Use Hide 'n' Seek Kids Unit 11 Material)

Story: The Case of the Most Important Question *Acts 16*

Bible Verse: Romans 6:23

BIBLE TRUTH 1: When We Tell God Our Sins and Turn Away from Them (3 Lessons Available)

Story: The Case of the Changed Climber *Luke 19:1-9*

Bible Verse: 1 John 1:8-9

BIBLE TRUTH 2: When We Trust in Jesus as Our Own Savior (3 Lessons Available)

Story: The Case of the Amazed, Mad Man *Acts 8-9*

Bible Verse: Romans 10:9-10

BIBLE TRUTH 3: When the Holy Spirit Works in Our Hearts (3 Lessons Available)

Story: The Case of the Surprising, Second Birthday *John 3*

Bible Verse: Titus 3:5-7

Deep Down Detectives ESV Songs 11 Track Numbers

This is a listing of all songs mentioned in the unit curriculum. You may or may not choose to use all of the songs. They are listed in easy-reference order--NOT in the order used in the curriculum.

You may choose to simply burn a CD/load them onto an mp3 device in this order. Or, you may want to do what we do: choose the songs we want to use and create a play list of them in that order. Then, we burn a CD/upload the play list onto an mp3 device. A teacher only has to click forward to the next song, instead of hunting for the right track. The track number have been included as part of the title of each song, teachers will still have a reference to the track number listed in the curriculum (same as those listed below), even if you change the order on your customized play list.

SONGS USED EVERY UNIT OF THE CURRICULUM

- 1 The Classroom Song v.1
- 2 The Classroom Song v.2
- 3 The Classroom Song v.3
- 4 The Classroom Song v.4
- 5 Deep Down Detectives Theme Song
- 6 The Classroom Rules Song
- 7 Let's Pray Song
- 8 The Big Question Box Song
- 9 The Bible Chant Song
- 10 ACTS Prayer Song (Short Version)
- 11 ACTS Prayer Song (Full Version)

Why the Extra Songs?

Deep Down Detectives is a curriculum used by a wide age-span of kids. Sometimes one of the other songs is a better fit for your kids. Or, you may simply want to teach them more songs on the same Bible Truth. Use as many or as few as you want.

listen to or download songs for free at <https://praisefactory.org>: Deep Down Detectives Music page

UNIT 11: THE GOD WHO SAVES

- 12 Big Q & A 11 Song
- 13 Big Question 11 Song: How Can I Be Saved?
- 14 Big Question 11 Bible Verse Song: The Free Gift of God Is Eternal Life Romans 6:23, ESV
- 15 Big Question 11 Hymn: Grace Greater than All Our Sin, refrain
- 16 Big Question 11 Praise Song: Blessed Be the Name

How Can We Be Saved?

It Is God's Free Gift...

Bible Truth 1: When We Tell God Our Sins and Turn Away from Them

- 17 Bible Verse: If We Say We Have No Sin 1 John 1:8-9, ESV
- 18 Bible Verse: If We Say 1 John 1:8-9, ESV

Bible Truth 2: When We Trust in Jesus as Our Own Savior

- 19 Bible Verse: If You Confess with Your Mouth Romans 10:9-10, ESV
- 20 Extra Bible Verse: In My Father's House John 14:2-6, ESV

Bible Truth 3: When the Holy Spirit Works in Our Hearts

- 21 Bible Verse: He Saved Us Titus 3:5-7, ESV
- 22 Extra Bible Verse: I Will Give You a New Heart Ezekiel 36:26, ESV

DEEP DOWN DETECTIVES



**Unit 11,
Bible Truth 1
Simple Story Scenes**

Using Simple Story Scenes as a Curriculum

Introduce the Key Concept and Bible Verse

Simple Story Scenes give you the basics for the core of your lesson. You can use the overview sheet to introduce and explain the key concept and Bible verse.

Give the Case Assignment

Give the children a Detective Dan listening assignment. Two are provided. You can add a third using the ideas on the bonus, third take-home sheet, if desired. Each listening assignment, let's you teach the story with a different learning emphasis.

Show & Tell the Story

Hold up the pictures and tell the story from the story scenes. Alternatively, you can find in the and Pieces section for this unit at praisefactory.org, these same listening assignments and story scenes, gospel and ACTS prayer modified for view on a screen. Simply download them or open them online and show through your own monitor (tablet, big screen, whatever).

Solve the Case

Repeat Detective Dan's listening assignment question and discuss the answer.

Share the Gospel

Share the gospel tie-in with the kids.

Close in ACTS Prayer

Pray the ACTS prayer with the kids. If using the curriculum with older children, give them a chance to think up their own ACTS tie-ins to the story, using the one provided as cues/ideas for you.

Review Time

Give out the take-home sheet (there are three: two that correlates to the two Detective Dan assignments in the Story Scenes, and a bonus third one.) As the children are coloring, use the take-home sheet discussion questions or your own questions to further review and apply the key concepts, Bible verse, and story truths to the children.

Looking for more?

Online, in the Bits and Pieces section for this unit, you will find review games, crafts, storyboard flannelgraph figures, and audio and sheet music for all of the songs. There are also full lesson plans that offer more of a script and take this curriculum's possibilities to much more depth. Don't forget to tell the parents about the Parents Resources section where they can read through the Story scenes and download take homes with their kids.

Unit 11: The God Who Saves

Unit Big Question (and Answer): How Can We Be Saved? It Is God's Free Gift!

Unit Bible Verse: "For the wages of sin is death, but the free gift of God is eternal life in Christ Jesus our Lord."
--- Romans 6:23, ESV

Bible Truth 1 Concept: It's God's Free Gift... When We Tell God Our Sins and Turn Away from Them!

We are all sinners who disobey God. We hear God's laws from the Bible and we know that we have broken them. We hear how we are supposed to love God and His good ways, and we know that we do not. We hear about God's punishment for sin, and we know that we deserve it.

But God is so merciful! He has provided a way to save us from His punishment. How? God wants us to tell (confess) our sins to Him and ask for His forgiveness through His Son, Jesus, who died on the cross to take the punishment for the sins of God's people. And, God wants us to turn away from a life of disobeying Him and ask Him to help us to live for Him instead (that's what it means to repent of our sins.)

If we do these things, God promises to forgive our sins and make us His very own people. We will get to know Him in our hearts by His Holy Spirit now. And one day, when we die, we will go to live perfectly happily with Him forever.

Bible Truth 1 Bible Verse: 1 John 1:8-9

"If we say we have no sin, we deceive ourselves, and the truth is not in us. If we confess our sins, he is faithful and just to forgive us our sins and to cleanse us from all unrighteousness."

Learn a Little: "If we confess our sins, he is faithful to forgive our sins."

Meaning

This verse reminds us that we are all sinners. We deceive ourselves if we think we are not. But, the good news is, that if we admit we are sinners and confess our sins to God, He is faithful and just and will forgive us our sins and save us through Jesus.

Bible Truth 1 ACTS Prayer

- A** God, we praise You for being faithful and just, and able to forgive our sins.
- C** God, we confess that we are all sinners who need You to save us. We can never be acceptable to You on our own. We need Jesus to save us!
- T** Thank You, God, for being willing to forgive all our sins, when we confess them, turn away from them, and trust in Jesus as our Savior.
- S** God, work in our hearts. Show us our sins and our need for Jesus to save us. Help us to confess our sins to You and turn away from them. Help us to trust in Jesus as our Savior. Be our Heavenly Father! Make us Your adopted children who love You and whom You will love forever.

In Jesus' name we pray, Amen.

Bible Truth 1 Story**The Case of the Changed Climber**

Luke 19:1-9

Songs Used in Bible Truth 1

Big Q & A 11 Song

Big Question 11 Song: How Can I Be Saved?

Big Question 11 Bible Verse Song: The Free Gift of God Is Eternal Life Romans 6:23, ESV

Big Question 11 Hymn: Grace Greater than All Our Sin, refrain

Big Question 11 Praise Song: Blessed Be the Name

Bible Truth 1 Bible Verse Song: If We Say We Have No Sin 1 John 1:8-9, ESV

Extra Bible Truth 1 Bible Verse Song: If We Say 1 John 1:8-9, ESV

listen to or download songs for free at <https://praisefactory.org>: Deep Down Detectives Music page

“The Case of the Changed Climber” Luke 19:1-9

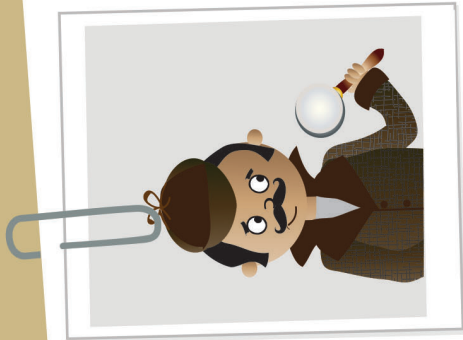

Detective Dan's Listening Assignment #1

1. Who was the climber and why did he climb?
2. How did he change?



Detective Dan's Listening Assignment #2

1 John 1:8-9, ESV

“If we say we have no sin, we deceive ourselves, and the truth is not in us. If we confess our sins, he is faithful and just to forgive us our sins and to cleanse us from all unrighteousness.”

1. Who wanted to confess his sins and be forgiven by God?
2. Who didn't think he should be forgiven?
Who did think he should be forgiven?

(more listening and discussion questions are included in the curriculum at praisefactory.org)

I. Zacchaeus was a rich, rich, rich man! He could have lots of fine clothes. He could have a big, big house. He could eat all the yummiest foods. He could buy all the nice things he liked. Yes. Zacchaeus could have almost anything he wanted because he was so rich.



1. Zacchaeus was a rich, rich, rich man! He could have lots of fine clothes. He could have a big, big house. He could eat all the yummiest foods. He could buy all the nice things he liked. Yes. Zacchaeus could have almost anything he wanted because he was so rich.

2. But even though Zacchaeus could have almost ANYTHING he wanted, and almost ANYTHING money could buy, there was something that Zacchaeus did NOT have. It was something money could NOT buy. Zacchaeus wanted God to forgive his sins.



2. But even though Zacchaeus could have almost **ANYTHING** he wanted, and almost **ANYTHING** money could buy, there was something that Zacchaeus did **NOT** have. It was something money could **NOT** buy. Zacchaeus wanted God to forgive his sins.

3. Now, we know that no one deserves God's forgiveness of their sins. We have all disobeyed God. We all deserve His punishment. But to many, Zacchaeus ESPECIALLY didn't deserve to have his sins forgiven.

You see, Zacchaeus had chosen to work for Caesar, the big king in Rome. Caesar's soldiers had taken over Israel, the country where Zacchaeus and the other people lived. And one of the big things Caesar wanted from the people in Israel was MONEY. TAX MONEY.



3. Now, we know that no one deserves God's forgiveness of their sins. We have all disobeyed God. We all deserve His punishment. But to many, Zacchaeus **ESPECIALLY** didn't deserve to have his sins forgiven. You see, Zacchaeus had chosen to work for Caesar, the big king in Rome. Caesar's soldiers had taken over Israel, the country where Zacchaeus and the other people lived. And one of the big things Caesar wanted from the people in Israel was **MONEY. TAX MONEY.**

4. The people of Israel hated to give the Roman king tax money, and most of them refused to help him collect it. But not Zacchaeus. Zacchaeus loved money and when the king offered to give him lots of money to collect taxes, Zacchaeus agreed.

“Zacchaeus, collect my tax money, and any extra you get, you can keep for yourself;” the big, Roman king promised.



4. The people of Israel hated to give the Roman king tax money, and most of them refused to help him collect it. But not Zacchaeus. Zacchaeus loved money and when the king offered to give him lots of money to collect taxes, Zacchaeus agreed. "Zacchaeus, collect my tax money, and any extra you get, you can keep for yourself," the big, Roman king promised.

5. So, that's what Zacchaeus did! He became the head tax collector in the important city of Jericho.

Zacchaeus and his men worked to get lots of money for Caesar and for themselves. Zacchaeus set up a booth along the road outside of Jericho. He stopped everyone along the road and made them pay taxes on their things. "Stop! No one passes by without paying the king's tax," demanded Zacchaeus and his men.



5. So, that's what Zacchaeus did! He became the head tax collector in the important city of Jericho. Zacchaeus and his men worked to get lots of money for Caesar and for themselves. Zacchaeus set up a booth along the road outside of Jericho. He stopped everyone along the road and made them pay taxes on their things. "Stop! No one passes by without paying the king's tax," demanded Zacchaeus and his men.

6. They did the same thing to the people of Jericho. Zacchaeus and his men knocked on every door. “Bang, bang, bang! Pay your tax money right now,” they ordered everyone.

Rich people, poor people. Healthy people, sick people. Everyone was ordered to pay, no matter how hard it was for them. No one wanted to pay. Many couldn’t pay.



6. They did the same thing to the people of Jericho. Zacchaeus and his men knocked on every door. "Bang, bang, bang! Pay your tax money right now," they ordered everyone. Rich people, poor people. Healthy people, sick people. Everyone was ordered to pay, no matter how hard it was for them. No one wanted to pay. Many couldn't pay.

7. But that didn't stop Zacchaeus. He and his men took soldiers with them to do whatever was needed to make people pay.

So, pay they did, the amount Caesar wanted for his taxes, and a lot more that Zacchaeus and his men kept for themselves. Zacchaeus didn't mind if the people were scared. He didn't mind if he took too much money or made their lives sad. He didn't care what happened to anyone else. He only wanted more money for himself.



7. But that didn't stop Zacchaeus. He and his men took soldiers with them to do whatever was needed to make people pay. So, pay they did, the amount Caesar wanted for his taxes, and a lot more that Zacchaeus and his men kept for themselves. Zacchaeus didn't mind if the people were scared. He didn't mind if he took too much money or made their lives sad. He didn't care what happened to anyone else. He only wanted more money for himself.

8. So, that's how Zacchaeus got to be so rich, rich, rich. And that's why people of Jericho and many others, thought Zacchaeus ESPECIALLY didn't deserve God's forgiveness.

**"How could God forgive someone like Zacchaeus," they exclaimed.
"He's such a mean, greedy bully. Surely, there is no forgiveness for someone like that!"**



8. So, that's how Zacchaeus got to be so rich, rich, rich. And that's why people of Jericho and many others, thought Zacchaeus **ESPECIALLY** didn't deserve God's forgiveness. "How could God forgive someone like Zacchaeus," they exclaimed. "He's such a mean, greedy bully. Surely, there is no forgiveness for someone like that!"

9. You might think all that money made Zacchaeus happy, and perhaps it did for a while. You see, fine clothes, a big house, yummy food, and nice things are wonderful. But, in the end, none of them are enough.

Why? Because God made us to know, love, and obey Him. He, alone, can make us truly happy. And that's why deep down in his heart, Zacchaeus was very UN-happy, even with all that money and those nice things. They would never be enough to satisfy him.



9. You might think all that money made Zacchaeus happy, and perhaps it did for a while. You see, fine clothes, a big house, yummy food, and nice things are wonderful. But, in the end, none of them are enough. Why? Because God made us to know, love, and obey Him. He, alone, can make us truly happy. And that's why deep down in his heart, Zacchaeus was very UN-happy, even with all that money and those nice things. They would never be enough to satisfy him.

10. What was worse, Zacchaeus knew God's laws, and he knew that he had broken them. He had done many terrible things to the people in his town and the people who passed along the road. He had hurt those people and now they hated him. Zacchaeus knew that he had chosen to turn away from God and His good ways. He had rebelled against God and deserved His punishment.



10. What was worse, Zacchaeus knew God's laws, and he knew that he had broken them. He had done many terrible things to the people in his town and the people who passed along the road. He had hurt those people and now they hated him. Zacchaeus knew that he had chosen to turn away from God and His good ways. He had rebelled against God and deserved His punishment.

II. It seemed like there was no way for Zacchaeus to come back to God now. Why, a man who had done such bad things wasn't even allowed to go in the worship house to worship God!

How could a man this bad ever find forgiveness from God? Surely, there was no way!



II. It seemed like there was no way for Zacchaeus to come back to God now. Why, a man who had done such bad things wasn't even allowed to go in the worship house to worship God! How could a man this bad ever find forgiveness from God? Surely, there was no way!

12. But there W/AS a way to be forgiven. God had made a way through His Son, Jesus, as Zacchaeus found out one day.



12. But there WAS a way to be forgiven. God had made a way through His Son, Jesus, as Zacchaeus found out one day.

13. Jesus and a crowd of people were passing through Jericho on the way to the big city of Jerusalem. “Jesus is coming! Jesus is coming!” the exciting news spread throughout the town.

Many gathered along the side of the road to see Jesus, squeezing together until there was no more room. Everyone wanted to hear Jesus teach about God and watch Him do amazing things by God’s great power.



13. Jesus and a crowd of people were passing through Jericho on the way to the big city of Jerusalem. "Jesus is coming! Jesus is coming!" the exciting news spread throughout the town. Many gathered along the side of the road to see Jesus, squeezing together until there was no more room. Everyone wanted to hear Jesus teach about God and watch Him do amazing things by God's great power.

14. Zacchaeus tried to join the crowd to see Jesus, too, but no one would make room for him.

Zacchaeus stood behind the crowd and tried to look over their heads, but he was such a short, little man that he couldn't see anything. Oh, if someone would just let him through to the front so he could see Jesus, too! But why would people help HIM after all the terrible things he had done?

"I must see Jesus! I must see Jesus!" Zacchaeus thought. He would not give up. Up! Why that was it. Zacchaeus had an idea.



14. Zacchaeus tried to join the crowd to see Jesus, too, but no one would make room for him. Zacchaeus stood behind the crowd and tried to look over their heads, but he was such a short, little man that he couldn't see anything. Oh, if someone would just let him through to the front so he could see Jesus, too! But why would people help HIM after all the terrible things he had done? "I must see Jesus! I must see Jesus!" Zacchaeus thought. He would not give up. Up! Why that was it. Zacchaeus had an idea.

15. Zacchaeus would climb up a tree, then he could see Jesus without anyone getting in his way.

So, that's just what Zacchaeus did! He ran down the road, beyond the crowd, and climbed up a big, sycamore tree. Zacchaeus sat on his tree branch and watched as Jesus and the crowd with him came closer and closer and closer.

What would happen? Would Jesus see Zacchaeus?



15. Zacchaeus would climb up a tree, then he could see Jesus without anyone getting in his way. So, that's just what Zacchaeus did! He ran down the road, beyond the crowd, and climbed up a big, sycamore tree. Zacchaeus sat on his tree branch and watched as Jesus and the crowd with him came closer and closer. What would happen? Would Jesus see Zacchaeus?

16. It would have been so easy for Jesus to miss the short, little man hiding up among the leaves. But Jesus did NOT miss Zacchaeus. Jesus was LOOKING for him.

Jesus knew all the terrible things Zacchaeus had done. He knew the sin in Zacchaeus' heart that made him so unhappy and separated him from God. And Jesus knew that He could bring Zacchaeus the forgiveness from God he longed for.



16. It would have been so easy for Jesus to miss the short, little man hiding up among the leaves. But Jesus did NOT miss Zacchaeus. Jesus was **LOOKING** for him. Jesus knew all the terrible things Zacchaeus had done. He knew the sin in Zacchaeus' heart that made him so unhappy and separated him from God. And Jesus knew that He could bring Zacchaeus the forgiveness from God he longed for.

17. So, instead of passing by Zacchaeus, Jesus led the crowd of people right up to that tree and stopped. He looked up through the leaves and straight at Zacchaeus.

What would Jesus say to Zacchaeus? What would Jesus DO to Zacchaeus? Zacchaeus was such a bad man and Jesus was so good! Would Jesus say angry things to Zacchaeus for all the bad things he had done? Would Jesus tell him there was no hope for a bad man like him?



17. So, instead of passing by Zacchaeus, Jesus led the crowd of people right up to that tree and stopped. He looked up through the leaves and straight at Zacchaeus. What would Jesus say to Zacchaeus? What would Jesus DO to Zacchaeus? Zacchaeus was such a bad man and Jesus was so good! Would Jesus say angry things to Zacchaeus for all the bad things he had done? Would Jesus tell him there was no hope for a bad man like him?

18. Jesus had GOOD news for Zacchaeus. He had come to bring people like him to God! People who knew they had broken God's laws. Jesus had come to bring them God's forgiveness and to save them from God's punishment, no matter how bad they had been.

So, Jesus looked up at Zacchaeus, and said, "Zacchaeus, hurry and come down, for I must stay at your house today." Zacchaeus was shocked and so happy. Good teachers like Jesus never asked to stay at the house of bad men like him, no matter how rich they were!



18. Jesus had GOOD news for Zacchaeus. He had come to bring people like him to God! People who knew they had broken God's laws. Jesus had come to bring them God's forgiveness and to save them from God's punishment, no matter how bad they had been. So, Jesus looked up at Zacchaeus, and said, "Zacchaeus, hurry and come down, for I must stay at your house today." Zacchaeus was shocked and so happy. Good teachers like Jesus never asked to stay at the house of bad men like him, no matter how rich they were!

19. Zacchaeus knew what this meant. Jesus wasn't just asking to stay at his big house to enjoy his nice things and yummy food. Jesus was asking to stay at his house to welcome him back to God.

Oh, what wonderful news! More than all the fine clothes, the big house, the yummy food, and the nice things in the world, Zacchaeus wanted to be welcomed back by God. Oh, how he wanted God to forgive his sins!



19. Zacchaeus knew what this meant. Jesus wasn't just asking to stay at his big house to enjoy his nice things and yummy food. Jesus was asking to stay at his house to welcome him back to God. Oh, what wonderful news! More than all the fine clothes, the big house, the yummy food, and the nice things in the world, Zacchaeus wanted to be welcomed back by God. Oh, how he wanted God to forgive his sins!

20. Right there, God's Holy Spirit did a wonderful thing in Zacchaeus' heart. He helped Zacchaeus turn away from disobeying God and trust in Jesus as his Savior. Zacchaeus was forgiven by God for all the terrible things he had done. God had saved Zacchaeus through Jesus!



20. Right there, God's Holy Spirit did a wonderful thing in Zacchaeus' heart. He helped Zacchaeus turn away from disobeying God and trust in Jesus as his Savior. Zacchaeus was forgiven by God for all the terrible things he had done. God had saved Zacchaeus through Jesus!

21. The town's people were shocked at Jesus' words and very unhappy!

"How can Jesus stay with such a bad man who's done such terrible things and broken God's laws? Zacchaeus has lied and cheated us. He has shouted at us and hurt us. Zacchaeus has used soldiers to scare us. He's not even allowed in the worship place, he's so bad! A good teacher like Jesus shouldn't have anything to do with Zacchaeus, and He CERTAINLY shouldn't stay at his house!" they grumbled.



21. The town's people were shocked at Jesus' words and very unhappy! "How can Jesus stay with such a bad man who's done such terrible things and broken God's laws? Zacchaeus has lied and cheated us. He has shouted at us and hurt us. Zacchaeus has used soldiers to scare us. He's not even allowed in the worship place, he's so bad! A good teacher like Jesus shouldn't have anything to do with Zacchaeus, and He **CERTAINLY** shouldn't stay at his house!" they grumbled.

22. Jesus and Zacchaeus knew the people were right. Zacchaeus had been a very bad man. He had done terrible things and broken God's laws. He didn't deserve for Jesus to stay with him.

But Jesus and Zacchaeus knew the people were wrong about something, too. God had worked in Zacchaeus' heart. God had helped Zacchaeus turn away from his old, bad ways, and trust in Jesus as his Savior. God had forgiven Zacchaeus. Zacchaeus was a changed man!



22. Jesus and Zacchaeus knew the people were right. Zacchaeus had been a very bad man. He had done terrible things and broken God's laws. He didn't deserve for Jesus to stay with him. But Jesus and Zacchaeus knew the people were wrong about something, too. God had worked in Zacchaeus' heart. God had helped Zacchaeus turn away from his old, bad ways, and trust in Jesus as his Savior. God had forgiven Zacchaeus. Zacchaeus was a changed man!

23. Zacchaeus came down from that tree and showed just how changed he was. In front of everyone he said, “Jesus, I’m going to give half of my money and nice things to poor people. And to the people I cheated, I’ll give back everything I took and give them a whole lot more!” he promised.



23. Zacchaeus came down from that tree and showed just how changed he was. In front of everyone he said, "Jesus, I'm going to give half of my money and nice things to poor people. And to the people I cheated, I'll give back everything I took and give them a whole lot more!" he promised.

24. “How amazing!” thought the town’s people. “This doesn’t sound like the same bad man who lied, cheated, and hurt us. This sounds like a NEW man, who loves God and wants to obey Him,” they exclaimed.

And that’s exactly what happened. God had changed Zacchaeus that day. God had helped him repent of his sins and trust in Jesus as his Savior.



24. "How amazing!" thought the town's people. "This doesn't sound like the same bad man who lied, cheated, and hurt us. This sounds like a NEW man, who loves God and wants to obey Him," they exclaimed. And that's exactly what happened. God had changed Zacchaeus that day. God had helped him repent of his sins and trust in Jesus as his Savior.

25. Then, Jesus said to Zacchaeus and all the people, “God sent me to seek and save people lost in their sins. And this is just what’s happened today. God has forgiven Zacchaeus and made him one of His people!”

Jesus! What a Savior for sinners!



25. Then, Jesus said to Zacchaeus and all the people, "God sent Me to seek and save people lost in their sins. And this is just what's happened today. God has forgiven Zacchaeus and made him one of His people!" Jesus! What a Savior for sinners!

DDD 1.1.1 Simple Story Scenes

“The Case of the Changed Climber” Luke 19:1-9

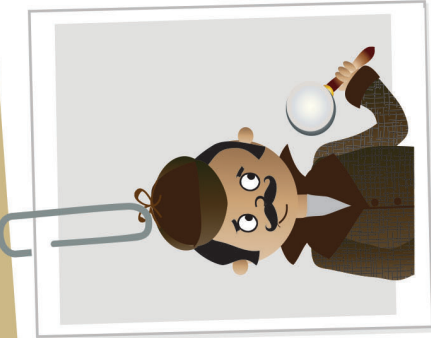

Detective Dan's Listening Assignment #1

1. Who was the climber and why did he climb? Zacchaeus was the climber. He climbed up a tree, so he could see Jesus.

2. How did he change? Zacchaeus turned away from his sins. He stopped being a mean, greedy cheat. He put his trust in Jesus as his Savior and God forgave his sins and made him one of His people.

What about You and Me? Like Zacchaeus, we All have disobeyed God and deserve His punishment. How sad! But like Zacchaeus, we, too, can confess our sins to God and turn away from them. We can trust in Jesus as our Savior. And if we do, God will forgive our sins and make us one of His people, just like He did for Zacchaeus.

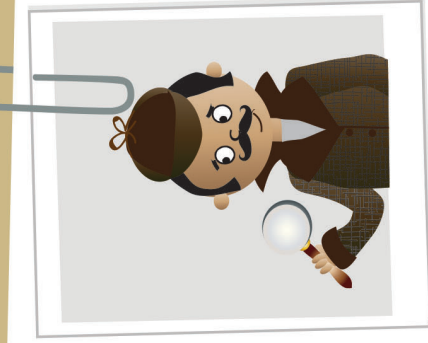

Detective Dan's Listening Assignment #2

1 John 1:8-9, ESV

“If we say we have no sin, we deceive ourselves, and the truth is not in us. If we confess our sins, he is faithful and just to forgive us our sins and to cleanse us from all unrighteousness.”

1. Who wanted to confess his sins and be forgiven by God? Zacchaeus did.

2. Who didn't think he should be forgiven? Who did think he should be forgiven?

The people in Zacchaeus' town of Jericho didn't think Zacchaeus should be forgiven by God. He was too bad of a man. But Jesus welcomed Zacchaeus to be forgiven by God.

What about you and me?

No one is too bad to be forgiven their sins by God. All who turn away from their sins and trust in Jesus as their Savior will be forgiven their sins and saved! God can do this for you and me, too. Ask Him! He loves to answer this prayer.

DDD 1.1.1 Simple Story Scenes

How Can We Be Saved?
It Is God's Free Gift...

When We Tell God Our Sins and Turn Away from Them!

The Gospel



We all have chosen to disobey God and His good laws. We deserve His punishment, not His love. And there's nothing we can do on our own to earn God's love.

But God is so merciful! He made the way for us to be saved from our sins and become His people, as His free gift. How? Through Jesus, His Son. Jesus lived a perfect life; then, on the cross, He gave it as the full payment for the sins of God's people. On the third day, Jesus rose from the dead. He had beaten sin and death for God's people.

Now, we can receive God's free gift of salvation when we tell God our sins, turn away from them, and trust in Jesus as our Savior. This is how we become God's people.

Ask Him to help you. He loves to do this!



DDD 1.1.1 Simple Story Scenes

A Prayer

A God, we praise You for being faithful and just, and able to forgive our sins.

C God, we confess that we are all sinners who need You to save us. We can never be acceptable to You on our own. We need Jesus to save us!

T Thank You, God, for being willing to forgive all our sins, when we confess them, turn away from them, and trust in Jesus as our Savior.

S God, work in our hearts. Show us our sins and our need for Jesus to save us. Help us to confess our sins to You and turn away from them. Help us to trust in Jesus as our Savior. Be our Heavenly Father! Make us Your adopted children who love You and whom You will love forever.

In Jesus' name we pray, Amen.



DDD 1.1.1 Simple Story Scenes

DEEP DOWN DETECTIVES

A decorative flourish consisting of a horizontal line with a small loop in the center, flanked by two teardrop-shaped elements pointing outwards.

**Unit 11,
Bible Truth 2
Simple Story Scenes**

Using Simple Story Scenes as a Curriculum

Introduce the Key Concept and Bible Verse

Simple Story Scenes give you the basics for the core of your lesson. You can use the overview sheet to introduce and explain the key concept and Bible verse.

Give the Case Assignment

Give the children a Detective Dan listening assignment. Two are provided. You can add a third using the ideas on the bonus, third take-home sheet, if desired. Each listening assignment, let's you teach the story with a different learning emphasis.

Show & Tell the Story

Hold up the pictures and tell the story from the story scenes. Alternatively, you can find in the and Pieces section for this unit at praisefactory.org, these same listening assignments and story scenes, gospel and ACTS prayer modified for view on a screen. Simply download them or open them online and show through your own monitor (tablet, big screen, whatever).

Solve the Case

Repeat Detective Dan's listening assignment question and discuss the answer.

Share the Gospel

Share the gospel tie-in with the kids.

Close in ACTS Prayer

Pray the ACTS prayer with the kids. If using the curriculum with older children, give them a chance to think up their own ACTS tie-ins to the story, using the one provided as cues/ideas for you.

Review Time

Give out the take-home sheet (there are three: two that correlates to the two Detective Dan assignments in the Story Scenes, and a bonus third one.) As the children are coloring, use the take-home sheet discussion questions or your own questions to further review and apply the key concepts, Bible verse, and story truths to the children.

Looking for more?

Online, in the Bits and Pieces section for this unit, you will find review games, crafts, storyboard flannelgraph figures, and audio and sheet music for all of the songs. There are also full lesson plans that offer more of a script and take this curriculum's possibilities to much more depth. Don't forget to tell the parents about the Parents Resources section where they can read through the Story scenes and download take homes with their kids.

Unit 11: The God Who Saves

Unit Big Question (and Answer): How Can We Be Saved? It Is God's Free Gift!

Unit Bible Verse: "For the wages of sin is death, but the free gift of God is eternal life in Christ Jesus our Lord."
--- Romans 6:23, ESV

Bible Truth 2 Concept: It Is God's Free Gift... When We Trust in Jesus as Our Own Savior!

God created us to love and obey Him, but we have all chosen to disobey Him. That's why we all deserve His punishment, instead of His friendship. Our sins separate us from Him. God would be fair to punish us for our sins, but He has chosen to be so kind to us. He offers to forgive our sins and make us His people through Jesus, His Son.

Jesus came to earth and lived a perfect life. He never, ever disobeyed God. Then on the cross, Jesus chose to offer up His perfect life as the perfect sacrifice for the sins of God's people. He took the punishment for sins they deserved to save them from their sins.

Jesus died on the cross and was buried in a grave, but He didn't stay there. He had beaten sin and death for God's people. He rose from the dead in victory, never to die again! Now, all who turn away from their sins and trust in Jesus as their Savior, are forgiven their sins. They are God's people who know Him in their hearts by His Holy Spirit. And when they die, they will go to live perfectly happy with Him forever. This wonderful, free gift can be ours, too, when we turn away from our sins and trust in Jesus as our own Savior. Isn't that wonderful news!

Bible Truth 2 Bible Verse: Romans 10:9-10

"If you confess with your mouth that Jesus is Lord and believe in your heart that God raised him from the dead, you will be saved. For with the heart one believes and is justified, and with the mouth one confesses and is saved."

Learn a Little: "If you confess Jesus is Lord and believe that God raised him from the dead, you will be saved."

Meaning

To believe something in your heart is to think that something is true. To confess something is to tell others what you think is true. Christians are those who believe in their hearts that Jesus is the Son of God, who died on the cross to save God's people from their sins. They believe that He rose from the dead on the third day, showing that He had beaten sin and death for them. They love telling this good news to others that they might believe and be saved, too. We must believe in our own hearts that He is our Savior and be willing to confess to others that He is our Lord, if we are to be saved, too!

Bible Truth 2 ACTS Prayer

- A** God, we praise You for being good and just. We honor You as the One we should all obey.
- C** God, we confess that we are all sinners who have disobeyed You. We know that we can never deserve to be Your people by good things we do. We need a Savior!
- T** Thank You, God, for sending Jesus as the Savior we need. Thank You that He made the way for us to become Your people with His perfect life given as the full payment for the sins of God's people.
- S** God, work in our hearts. Help us to confess our sins to You and turn away from them. Help us to trust in Jesus as our Savior that we might become Your people. Help us to know and love You. Help us to live for You. In Jesus' name we pray, Amen.

Bible Truth 2 Story

The Case of the Amazed, Mad Man Acts 8-9

Songs Used in Bible Truth 2 Songs Used in Bible Truth 2

Big Q & A 11 Song

Big Question 11 Song: How Can I Be Saved?

Big Question 11 Bible Verse Song: The Free Gift of God Is Eternal Life Romans 6:23, ESV

Big Question 11 Hymn: Grace Greater than All Our Sin, refrain

Big Question 11 Praise Song: Blessed Be the Name

Bible Truth 2 Bible Verse Song: If You Confess with Your Mouth Romans 10:9-10, ESV

Extra Bible Truth 2 Verse Song: In My Father's House John 14:2-6, ESV

listen to or download songs for free at <https://praisefactory.org>: Deep Down Detectives Music page

“The Case of the Amazed, Mad Man” Acts 8-9

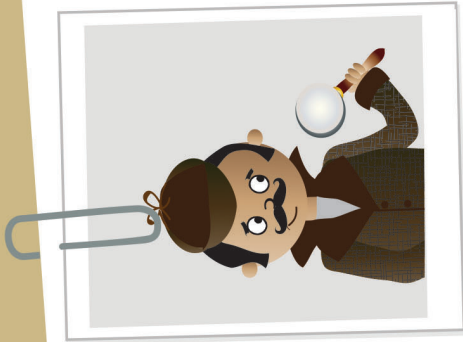

Detective Dan's Listening Assignment #1

1. Who was the man who was so mad? What was he so mad about?
2. What amazing thing happened to him? How did he change when it happened?



Detective Dan's Listening Assignment #2

Romans 10:9-10, ESV

“If you confess with your mouth that Jesus is Lord and believe in your heart that God raised him from the dead, you will be saved. For with the heart one believes and is justified, and with the mouth one confesses and is saved.”

1. Who told people to stop saying Jesus is the Savior?
2. Why did he change his mind?

(more listening and discussion questions are included in the curriculum at praisefactory.org)

I. Jesus' followers had good news to tell the people of Jerusalem: "Jesus is God's Son. He died on the cross to pay for the sins of God's people. On Day Three, He rose from the dead, beating sin and death for them," they said.

"Turn away from disobeying God. Trust in Jesus as your Savior, and God will forgive your sins. You will be saved!" they exclaimed. "You can become one of God's people, too," they told everyone.



I. Jesus' followers had good news to tell the people of Jerusalem: "Jesus is God's Son. He died on the cross to pay for the sins of God's people. On Day Three, He rose from the dead, beating sin and death for them," they said. "Turn away from disobeying God. Trust in Jesus as your Savior, and God will forgive your sins. You will be saved!" they exclaimed. "You can become one of God's people, too," they told everyone.

2. Many people in Jerusalem listened, and they believed. They turned away from their sins and trusted in Jesus as their own Savior. God forgave their sins and saved them. How happy they were to become God's people!



2. Many people in Jerusalem listened, and they believed. They turned away from their sins and trusted in Jesus as their own Savior. God forgave their sins and saved them. How happy they were to become God's people!

3. But some people listened to Jesus' followers, and they were NOT happy. They were ANGRY. Saul was one of those angry people. He HATED Jesus and the people who believed in Him.



3. But some people listened to Jesus' followers, and they were NOT happy. They were ANGRY. Saul was one of those angry people. He HATED Jesus and the people who believed in Him.

4. “Be quiet! Stop saying Jesus is God’s Son! Stop saying He died on the cross for the sins of God’s people and rose from the dead! Stop saying He’s the Savior,” Saul told Jesus’ followers.

“Jesus is just a fake!” he exclaimed. “You are all wrong. And if you don’t stop telling people about Jesus, I’m going to have you hurt and put you in jail,” he warned them.

Oh, no! What would Jesus’ followers do now?



4. "Be quiet! Stop saying Jesus is God's Son! Stop saying He died on the cross for the sins of God's people and rose from the dead! Stop saying He's the Savior," Saul told Jesus' followers. "Jesus is just a fake!" he exclaimed. "You are all wrong. And if you don't stop telling people about Jesus, I'm going to have you hurt and put you in jail," he warned them. Oh, no! What would Jesus' followers do now?

5. But no matter what Saul said, Jesus' followers didn't stop. They kept spreading the good news of Jesus. They kept urging everyone to turn away from their sins and trust in Him as their Savior. Uh, oh! NOW, what would Saul do?

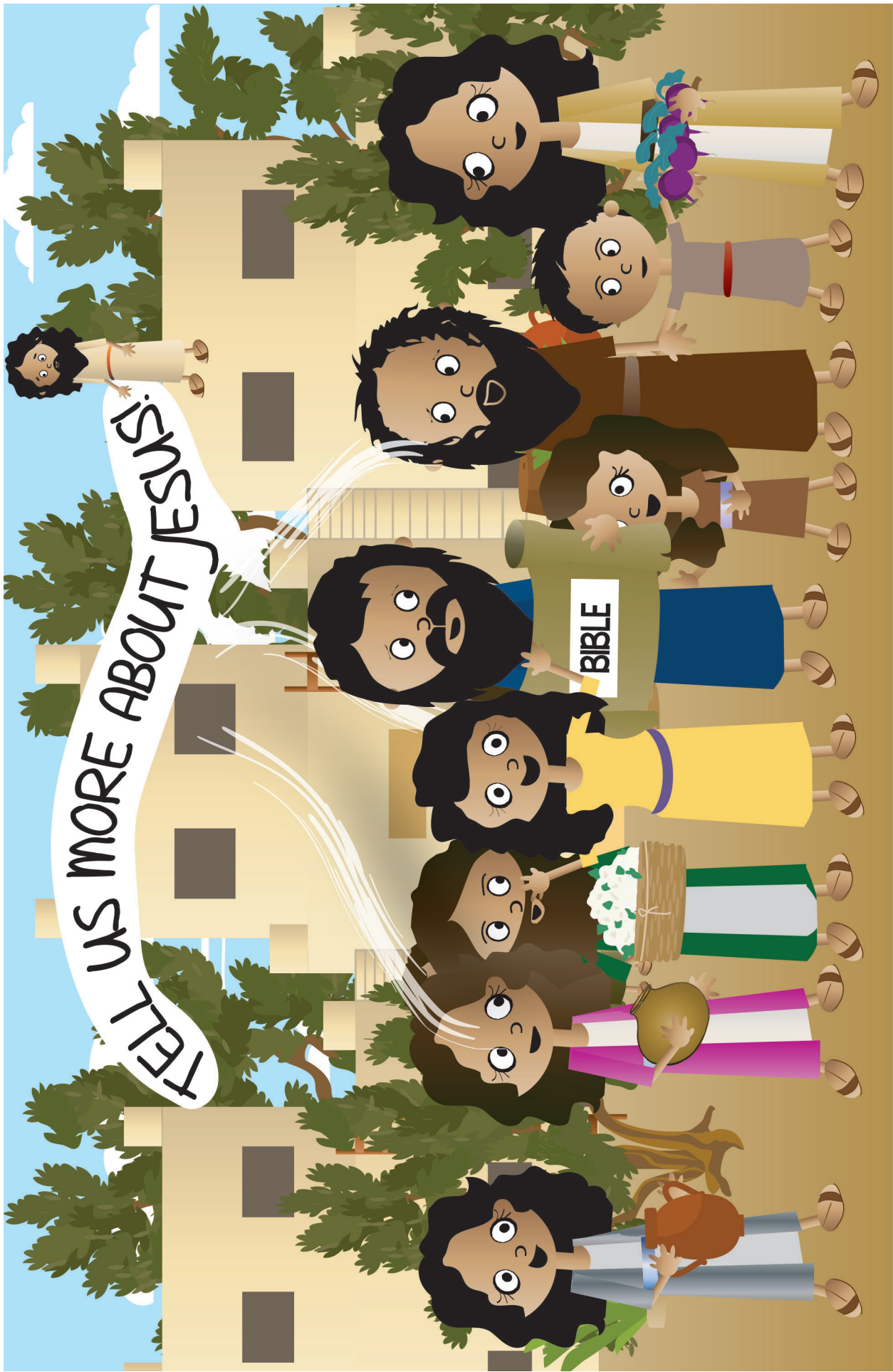

5. But no matter what Saul said, Jesus' followers didn't stop. They kept spreading the good news of Jesus. They kept urging everyone to turn away from their sins and trust in Him as their Savior. Uh, oh! NOW, what would Saul do?

6. Saul did exactly what he said he would do. He went from house to house with men to arrest them.

“Bang, bang, bang!” they knocked on the door. “Open up!” Saul and the men dragged Jesus’ followers out of their houses. They hurt them and put them in jail.

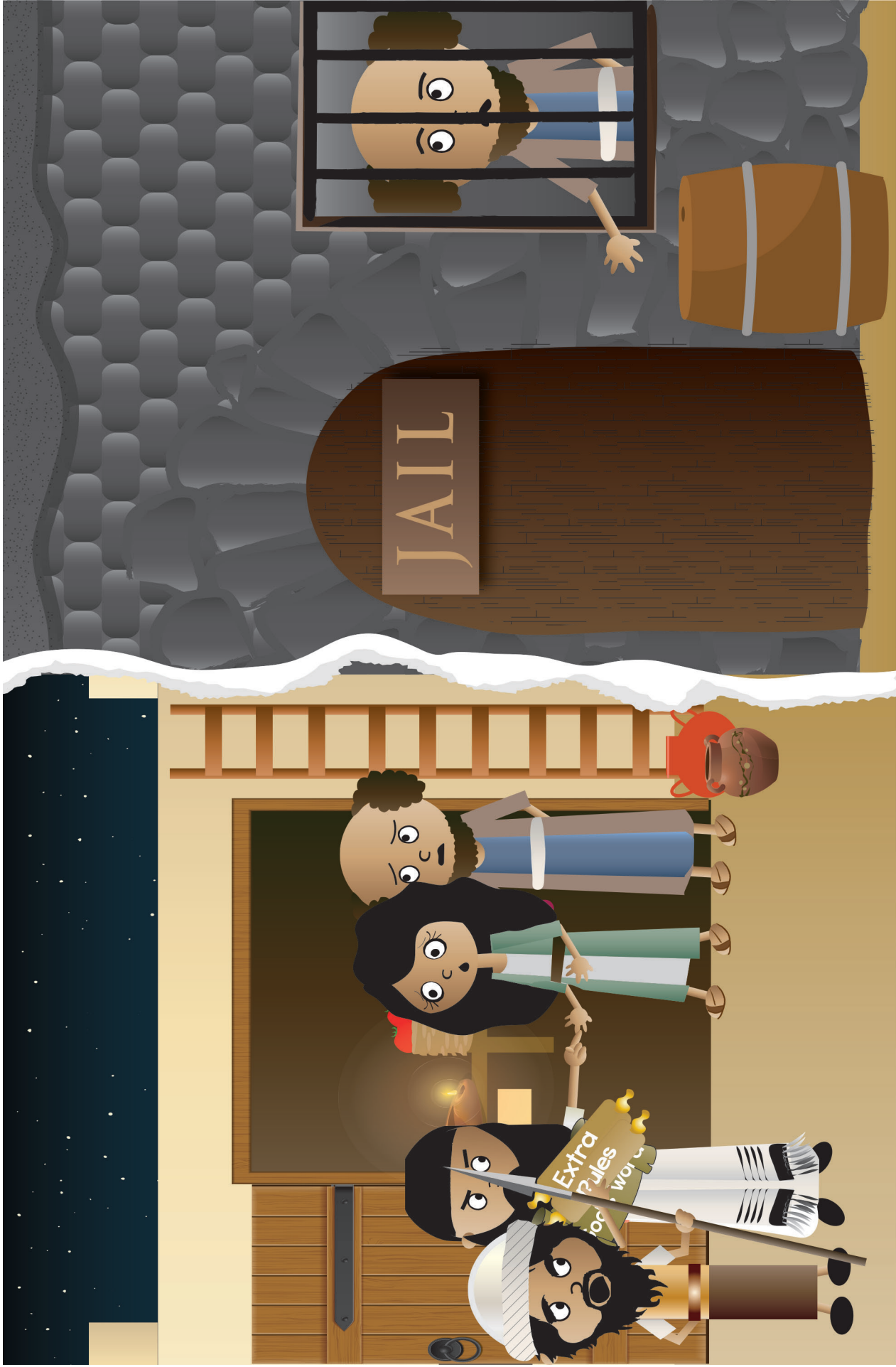

6. Saul did exactly what he said he would do. He went from house to house with men to arrest them. "Bang, bang, bang!" they knocked on the door. "Open up!" Saul and the men dragged Jesus' followers out of their houses. They hurt them and put them in jail.

7. Saul kept making it hard to tell the good news of Jesus in Jerusalem, but even this was part of God's plan.

“Jesus told us to tell the whole world about Him,” Jesus’ followers remembered. “Now it’s time to go. A few of us will stay here in Jerusalem, but everyone else should move away to other cities,” they decided. “People in those cities need to hear the good news of Jesus, too.”

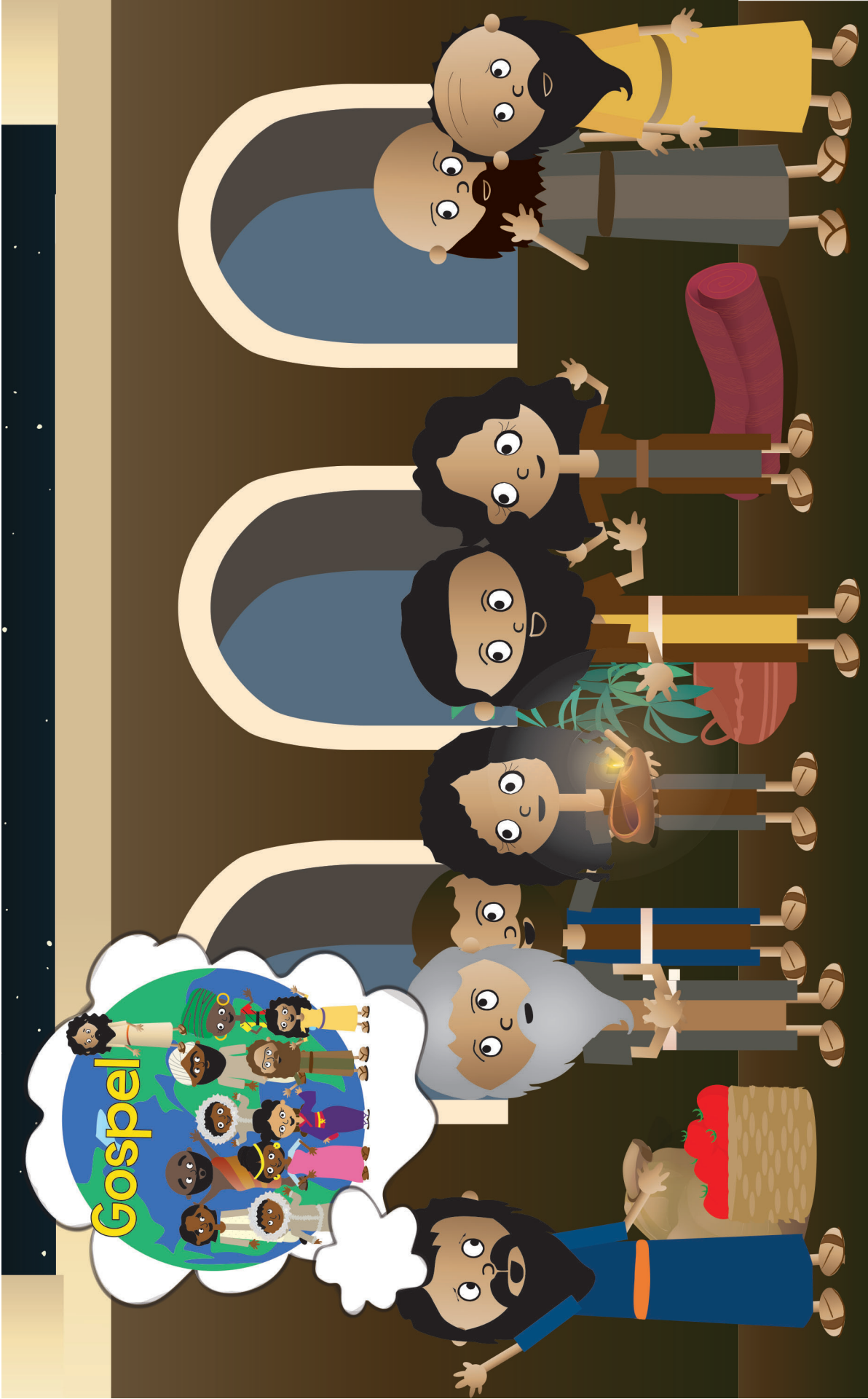

7. Saul kept making it hard to tell the good news of Jesus in Jerusalem, but even this was part of God's plan. "Jesus told us to tell the whole world about Him," Jesus' followers remembered. "Now it's time to go. A few of us will stay here in Jerusalem, but everyone else should move away to other cities," they decided. "People in those cities need to hear the good news of Jesus, too."

8. So, they packed up their things and moved to other cities. Some went to nearby cities. Others went to faraway cities. But wherever they went, they told everyone the same, good news about Jesus.



8. So, they packed up their things and moved to other cities. Some went to nearby cities. Others went to faraway cities. But wherever they went, they told everyone the same, good news about Jesus.

q. “Jesus is God’s Son. He died on the cross to pay for the sins of God’s people,” they told everyone. “Then, on the third day, Jesus rose from the dead. He beat sin and death for God’s people,” they explained.

“So, turn away from your sins. Trust in Jesus as your Savior. God will forgive your sins and make you one of His people, too. You will be saved!” they exclaimed.



9. "Jesus is God's Son. He died on the cross to pay for the sins of God's people," they told everyone. "Then, on the third day, Jesus rose from the dead. He beat sin and death for God's people," they explained. "So, turn away from your sins. Trust in Jesus as your Savior. God will forgive your sins and make you one of His people, too. You will be saved!" they exclaimed.

10. What good news this was! Many people in these cities listened and received the gospel with joy. They turned away from their sins and trusted in Jesus as their Savior.

How happy Jesus' followers were to see the people in these new cities believing in Jesus, too!



10. What good news this was! Many people in these cities listened and received the gospel with joy. They turned away from their sins and trusted in Jesus as their Savior. How happy Jesus' followers were to see the people in these new cities believing in Jesus, too!

II. But there was someone who was very angry when he heard about this. Can you guess who it was? It was Saul! He heard what was going on and he was furious!

“I will stop these Christians,” he vowed. So, Saul went to the high priest, the leader of Jesus’ enemies, and said, “If you give me men to go to these other cities, I will arrest the Christians. I will bring them back to Jerusalem and put them in jail. I will stop them,” Saul promised.



II. But there was someone who was very angry when he heard about this. Can you guess who it was? It was Saul! He heard what was going on and he was furious! "I will stop these Christians," he vowed. So, Saul went to the high priest, the leader of Jesus' enemies, and said, "If you give me men to go to these other cities, I will arrest the Christians. I will bring them back to Jerusalem and put them in jail. I will stop them," Saul promised.

12. The high priest agreed. He gave Saul men to help him arrest the Christians in the other cities. Saul was pleased.

“March, march, march,” Saul and the men headed straight for the first city: Damascus. Saul could hardly wait to arrest those Christians and put them in jail. Now, he would stop all this talk about Jesus... or would he?



12. The high priest agreed. He gave Saul men to help him arrest the Christians in the other cities. Saul was pleased. "March, march, march," Saul and the men headed straight for the first city: Damascus. Saul could hardly wait to arrest those Christians and put them in jail. Now, he would stop all this talk about Jesus... or would he?

13. Well, as it turned out, God, Himself, had very, very different plans for Saul. God was about to change Saul's life completely. He would use Saul to spread the gospel, not stop it.

Saul believed Jesus was a fake; but, of course, He wasn't. Jesus was the REAL Son of God. He really died on the cross and rose from the dead, beating sin and death for God's people.

And now, God was going to give Saul the gift of faith in Jesus. He would make Saul one of His people, then use Saul to spread the good news to many. Aren't God's plans amazing?



13. Well, as it turned out, God, Himself, had very, very different plans for Saul. God was about to change Saul's life completely. He would use Saul to spread the gospel, not stop it. Saul believed Jesus was a fake; but, of course, He wasn't. Jesus was the REAL Son of God. He really died on the cross and rose from the dead, beating sin and death for God's people. And now, God was going to give Saul the gift of faith in Jesus. He would make Saul one of His people, then use Saul to spread the good news to many. Aren't God's plans amazing?

14. But how would Saul, a man who HATED Jesus and His followers, change into someone who trusted Jesus as his own Savior? God chose to change Saul in a most amazing way.

Just as Saul and the soldiers were almost to Damascus, a light from heaven, much brighter than the sun, suddenly shone down on them.



14. But how would Saul, a man who HATED Jesus and His followers, change into someone who trusted Jesus as his own Savior? God chose to change Saul in a most amazing way. Just as Saul and the soldiers were almost to Damascus, a light from heaven, much brighter than the sun, suddenly shone down on them.

15. Saul shut his eyes tight and he fell to the ground. Then, he heard a voice saying to him, “Saul, Saul, why are you hurting me?”

“Who are you, Lord?” Saul asked.

“I am Jesus, whom you are hurting,” Jesus told Saul. “But get up now and go to Damascus and you will be told what to do.”

The men with Saul stood there speechless; they heard the voice, but didn't see anyone.



15. Saul shut his eyes tight and he fell to the ground. Then, he heard a voice saying to him, “Saul, Saul, why are you hurting me? “Who are you, Lord?” Saul asked. “I am Jesus, whom you are hurting,” Jesus told Saul. “But get up now and go to Damascus and you will be told what to do.” The men with Saul stood there speechless; they heard the voice, but didn’t see anyone.

16. The bright, heavenly light vanished as quickly as it came, but not without leaving Saul with a problem. When he stood up and went to open his eyes, he couldn't see anything. Saul was blind!



16. The bright, heavenly light vanished as quickly as it came, but not without leaving Saul with a problem. When he stood up and went to open his eyes, he couldn't see anything. Saul was blind!

17. The men took Saul by hand the rest of the way to Judas' house in Damascus. For three days, Saul didn't eat or drink. He just prayed and thought about everything Jesus said.

Now, Saul knew the truth. He thought Jesus was a fake, and His believers were wrong. Now, Saul knew HE was the one who was wrong. Jesus WAS the Savior. He WAS God's Son. And Jesus' followers, they were GOD'S people! Oh my! He had been hurting God's people! Saul knew he deserved God's punishment for the terrible things he had done.



17. The men took Saul by hand the rest of the way to Judas' house in Damascus. For three days, Saul didn't eat or drink. He just prayed and thought about everything Jesus said. Now, Saul knew the truth. He thought Jesus was a fake, and His believers were wrong. Now, Saul knew HE was the one who was wrong. Jesus WAS the Savior. He WAS God's Son. And Jesus' followers, they were GOD'S people! Oh my! He had been hurting God's people! Saul knew he deserved God's punishment for the terrible things he had done.

18. But as Saul prayed, he asked God for more than he deserved. He asked for forgiveness.

And what did God do? God helped Saul turn away from his sins and trust in Jesus as his own Savior. Saul was forgiven! He was saved! How kind God is to sinners like Saul, and like us!



18. But as Saul prayed, he asked God for more than he deserved. He asked for forgiveness. And what did God do? God helped Saul turn away from his sins and trust in Jesus as his own Savior. Saul was forgiven! He was saved! How kind God is to sinners like Saul, and like us!

19. After three days, God sent a Christian named Ananias to Saul.

“Brother Saul, Jesus, who appeared to you, has sent me so you may see again and be filled with the Holy Spirit,” he told Saul.

Ananias laid his hands on Saul and something like scales fell off his eyes. God had healed him! But what happened next was even better: God’s Holy Spirit came to live in Saul’s heart.



19. After three days, God sent a Christian named Ananias to Saul. "Brother Saul, Jesus, who appeared to you, has sent me so you may see again and be filled with the Holy Spirit," he told Saul. Ananias laid his hands on Saul and something like scales fell off his eyes. God had healed him! But what happened next was even better: God's Holy Spirit came to live in Saul's heart.

20. Saul was so happy. God had saved him from his sins through Jesus. He had made Saul one of His people. Saul was a new man!

He got up and was baptized, as Jesus commanded. Saul was beginning a new life of living for God, with Jesus as his Savior. Then, Saul went out and did something else. Something he never, ever dreamed he would do. Can you guess what he did?



20. Saul was so happy. God had saved him from his sins through Jesus. He had made Saul one of His people. Saul was a new man! He got up and was baptized, as Jesus commanded. Saul was beginning a new life of living for God, with Jesus as his Savior. Then, Saul went out and did something else. Something he never, ever dreamed he would do. Can you guess what he did?

21. Saul went out to tell the good news of Jesus to the people of Damascus.

“Jesus is God’s Son. He died on the cross to pay for the sins of God’s people,” Saul told them. “On the third day, He rose from the dead. He beat sin and death for God’s people!” he exclaimed. “Turn away from disobeying God! Trust in Jesus as your Savior. God will forgive your sins and save you. You can be one of God’s people!”

22. How surprised the people were! “Wasn’t this the man who hated Jesus and His followers? Wasn’t this the man who hurt them and put them in jail? And now HE is one of THEM!” they exclaimed.

And as Saul preached about Jesus, the Holy Spirit worked in the hearts of many. They turned away from their sins and trusted in Jesus as their Savior.

All of God’s good plans were coming true. His good plans for Saul, and His good plans for the many others, who would trust in Jesus as their Savior through Saul’s message. How amazing God is!



22. How surprised the people were! “Wasn’t this the man who hated Jesus and His followers? Wasn’t this the man who hurt them and put them in jail? And now HE is one of THEM!” they exclaimed. And as Saul preached about Jesus, the Holy Spirit worked in the hearts of many. They turned away from their sins and trusted in Jesus as their Savior. All of God’s good plans were coming true. His good plans for Saul, and His good plans for the many others, who would trust in Jesus as their Savior through Saul’s message. How amazing God is!

DDD 11.2 Simple Story Scenes

“The Case of the Amazed, Mad Man” Acts 8-9

SOLVED

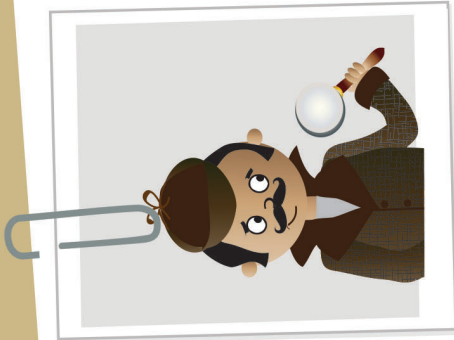

Detective Dan's Listening Assignment #1

1. Who was the man who was so mad? What was he so mad about?
Saul. He was mad that Jesus' followers were telling people to trust in Jesus as their Savior.
2. What amazing thing happened to him? How did he change when it happened?
Jesus appeared to Saul and Saul knew that He really was the Savior. Saul turned away from his sins and trusted in Jesus as his Savior. He started telling everyone the good news of Jesus.

For You and Me:
God turned Saul from a man who hated Jesus and wanted to hurt God's people, to someone who loved Jesus and served Him his whole life. God can work powerfully in our lives, too, when we turn away from our sins and trust in Jesus as our Savior.



Detective Dan's Listening Assignment #2

Romans 10:9-10, ESV

“If you confess with your mouth that Jesus is Lord and believe in your heart that God raised him from the dead, you will be saved. For with the heart one believes and is justified, and with the mouth one confesses and is saved.”

1. Who told people to stop saying Jesus is the Savior?
Saul did.
2. Why did he change his mind?
Jesus appeared to Saul and Saul knew that He really was the Savior. Saul turned away from his sins and trusted in Jesus as his Savior.

For You and Me:

How amazing it is that God could change someone like Saul from a man who hated Jesus to a man who loved Him and trusted in Him as his Savior. God can change us, too, when we turn away from our sins and trust in Jesus as our Savior.

DDD 11.2 Simple Story Scenes

How Can We Be Saved?
It Is God's Free Gift...

When We Trust in Jesus as Our Own Savior!

The Gospel



We all have chosen to disobey God and His good laws. We deserve His punishment, not His love. And there's nothing we can do on our own to earn God's love.

But God is so merciful! He made the way for us to be saved from our sins and become His people, as His free gift. How? Through Jesus, His Son. Jesus lived a perfect life; then, on the cross, He gave it as the full payment for the sins of God's people. On the third day, Jesus rose from the dead. He had beaten sin and death for God's people.

Now, we can receive God's free gift of salvation when we tell God our sins, turn away from them, and trust in Jesus as our Savior. This is how we become God's people.

Ask Him to help you. He loves to do this!



DDD 11.2 Simple Story Scenes

A Prayer

A God, we praise You for being good and just. We honor You as the One we should all obey.

C God, we confess that we are all sinners who have disobeyed You. We know that we can never deserve to be Your people by good things we do. We need a Savior!

T Thank You, God, for sending Jesus as the Savior we need. Thank You that He made the way for us to become Your people with His perfect life given as the full payment for the sins of God's people.

S God, work in our hearts. Help us to confess our sins to You and turn away from them. Help us to trust in Jesus as our Savior that we might become Your people. Help us to know and love You. Help us to live for You.

In Jesus' name we pray. Amen.



DDD 11.2 Simple Story Scenes

DEEP DOWN DETECTIVES



**Unit 11,
Bible Truth 3
Simple Story Scenes**

Using Simple Story Scenes as a Curriculum

Introduce the Key Concept and Bible Verse

Simple Story Scenes give you the basics for the core of your lesson. You can use the overview sheet to introduce and explain the key concept and Bible verse.

Give the Case Assignment

Give the children a Detective Dan listening assignment. Two are provided. You can add a third using the ideas on the bonus, third take-home sheet, if desired. Each listening assignment, let's you teach the story with a different learning emphasis.

Show & Tell the Story

Hold up the pictures and tell the story from the story scenes. Alternatively, you can find in the and Pieces section for this unit at praisefactory.org, these same listening assignments and story scenes, gospel and ACTS prayer modified for view on a screen. Simply download them or open them online and show through your own monitor (tablet, big screen, whatever).

Solve the Case

Repeat Detective Dan's listening assignment question and discuss the answer.

Share the Gospel

Share the gospel tie-in with the kids.

Close in ACTS Prayer

Pray the ACTS prayer with the kids. If using the curriculum with older children, give them a chance to think up their own ACTS tie-ins to the story, using the one provided as cues/ideas for you.

Review Time

Give out the take-home sheet (there are three: two that correlates to the two Detective Dan assignments in the Story Scenes, and a bonus third one.) As the children are coloring, use the take-home sheet discussion questions or your own questions to further review and apply the key concepts, Bible verse, and story truths to the children.

Looking for more?

Online, in the Bits and Pieces section for this unit, you will find review games, crafts, storyboard flannelgraph figures, and audio and sheet music for all of the songs. There are also full lesson plans that offer more of a script and take this curriculum's possibilities to much more depth. Don't forget to tell the parents about the Parents Resources section where they can read through the Story scenes and download take homes with their kids.

Unit 11: The God Who Saves

Unit Big Question (and Answer): How Can We Be Saved? It Is God's Free Gift!

Unit Bible Verse: "For the wages of sin is death, but the free gift of God is eternal life in Christ Jesus our Lord."
--- Romans 6:23, ESV

Bible Truth 3 Concept: It Is God's Free Gift... When the Holy Spirit Works in Our Hearts!

All of us are sinners. We would rather do things our own way rather than obey God. We have hearts that are dead and empty of love for Him and His good ways. We would never choose to love God on our own.

But guess what God does for His people? He treats them so much better than they deserve! He sends His Holy Spirit to work in their hearts. When they hear God's Word, He helps them know they are sinners. He helps them want to stop disobeying God and trust in Jesus as their Savior. He makes their hearts alive to God. Now, they know God and want to obey and love Him.

We can be God's people, too! We can ask God to send the Holy Spirit to work in our hearts. He can help us to ask God to forgive our sins, trust Jesus as our Savior, and live for Him. Then we can know God in our hearts, now; and when we die, we will go to live perfectly happily with Him forever.

Bible Truth 3 Bible Verse: Titus 3:5, ESV

"...He saved us, not because of works done by us in righteousness, but according to his own mercy, by the washing of regeneration and renewal of the Holy Spirit."

Learn a Little: "He saved us by the Holy Spirit."

Meaning

We can never please God with our own, good works. Only through Jesus' perfect life offered up in the place of sinners can we be saved. And what a salvation it is! God, Himself, sends His Holy Spirit to work in the hearts of His people. He gives them the gift of faith. He helps them turn away from their sins. He makes them clean of their sins and all new on the inside. This is how we, too, can become God's people--His heirs; that is, His children who will receive eternal life and live with Him forever.

Bible Truth 3 ACTS Prayer

- A** God, we praise You for being the Changer of the hearts of sinful people, like us.
- C** God, we confess that we are all sinners. We have hard hearts that are slow to believe, love, and obey You. We need Jesus to save us!
- T** Thank You for sending Your Holy Spirit to work in the hearts of people like us, so we can know You, love You, and live for You. You give us what we need but could never get on our own.
- S** God, send the Holy Spirit to work in our hearts. Give us faith as we hear Your Word, the Bible. Help us to turn away from our sins and trust in Jesus as our Savior. Make us new creations! Give us the new birth! We want to know You and live for You! In Jesus' name we pray, Amen.

Bible Truth 3 Story

The Case of the Surprising, Second Birthday

John 3

Songs Used in Bible Truth 3

Big Q & A 11 Song

Big Question 11 Song: How Can I Be Saved?

Big Question 11 Bible Verse Song: The Free Gift of God Is Eternal Life Romans 6:23, ESV

Big Question 11 Hymn: Grace Greater than All Our Sin, refrain

Big Question 11 Praise Song: Blessed Be the Name

Bible Truth 3 Bible Verse Song: He Saved Us Titus 3:5-7, ESV

Extra Bible Truth 3 Bible Verse Song: I Will Give You a New Heart Ezekiel 36:26, ESV

listen to or download songs for free at <https://praisefactory.org>: Deep Down Detectives Music page

“The Case of the Surprising, Second Birthday” John 3



Detective Dan's Listening Assignment #1

1. What special kind of second birthday did Jesus promise to all who trust in him as their Savior?
2. To whom did Jesus tell about this birthday? What did he find so surprising about it?



Detective Dan's Listening Assignment #2

Titus 3:5, ESV

“He saved us, not because of works done by us in righteousness, but according to his own mercy, by the washing of regeneration and renewal of the Holy Spirit.”

1. What kind of special, second birthday does God give to each of His people?
2. Who does God send to work in their hearts and give them this special, second birthday?

(more listening and discussion questions are included in the curriculum at praisefactory.org)

1. To the country, to the cities, went Jesus and His disciples. And everywhere they went, people came. Jesus taught them about God and did amazing things by God's power.

Country

City



1. To the country, to the cities, went Jesus and His disciples. And everywhere they went, people came. Jesus taught them about God and did amazing things by God's power.

2. What kind of country people came to Jesus?

Well, there were plain, country people like shepherds, fishermen, and farmers. And there were important country people, like the teachers of God's Word and government workers. Poor people, rich people. Good people, bad people. Sick people, healthy people. Fathers, mothers, and children.

They all came to Jesus to hear Him teach about God and do amazing things.



2. What kind of country people came to Jesus? Well, there were plain, country people like shepherds, fishermen, and farmers. And there were important country people, like the teachers of God's Word and government workers. Poor people, rich people. Good people, bad people. Sick people, healthy people. Fathers, mothers, and children. They all came to Jesus to hear Him teach about God and do amazing things.

3. And amazed they certainly were, by what they heard and saw.

“This Jesus is not like any other teacher. What amazing things He says about God. What amazing things He does. He even heals sick people with just His words. Let’s hear more. Let’s see more,” they exclaimed.

Soon, big crowds of country people followed Jesus, listening to Him teach about God and watching the amazing things He did by God’s power.



3. And amazed they certainly were, by what they heard and saw. "This Jesus is not like any other teacher. What amazing things He says about God. What amazing things He does. He even heals sick people with just His words. Let's hear more. Let's see more," they exclaimed. Soon, big crowds of country people followed Jesus, listening to Him teach about God and watching the amazing things He did by God's power.

4. But you know, Jesus wasn't the only one doing amazing things by God's great power. God, the Holy Spirit, was doing some amazing things, too.

For as some of those country people listened to Jesus talk and watched the amazing things He did, God, the Holy Spirit, worked in their hearts, changing them. He helped them turn away from their sins and trust in Jesus as their Savior.

Yes, by His Holy Spirit, God was giving these people the best gift of all: the gift of being saved by faith in Jesus.

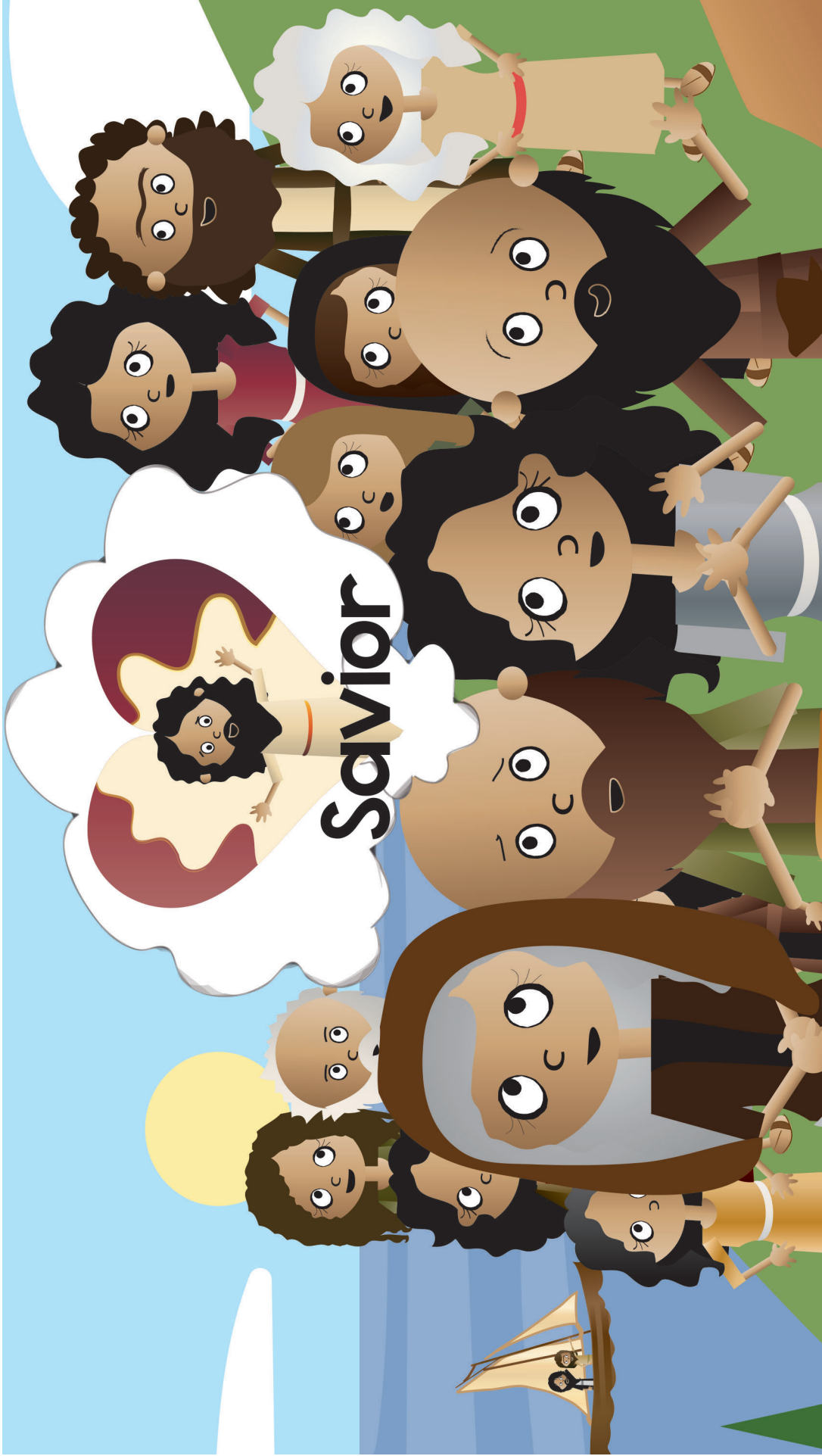

4. But you know, Jesus wasn't the only one doing amazing things by God's great power. God, the Holy Spirit, was doing some amazing things, too. For as some of those country people listened to Jesus talk and watched the amazing things He did, God, the Holy Spirit, worked in their hearts, changing them. He helped them turn away from their sins and trust in Jesus as their Savior. Yes, by His Holy Spirit, God was giving these people the best gift of all: the gift of being saved by faith in Jesus.

5. This wonderful gift meant God forgave their sins and made them His people. They could know and love God in their hearts. And one day, when they died, they would go live with Him, face-to-face forever.

What a wonderful thing the Holy Spirit was doing as those country people listened to Jesus!

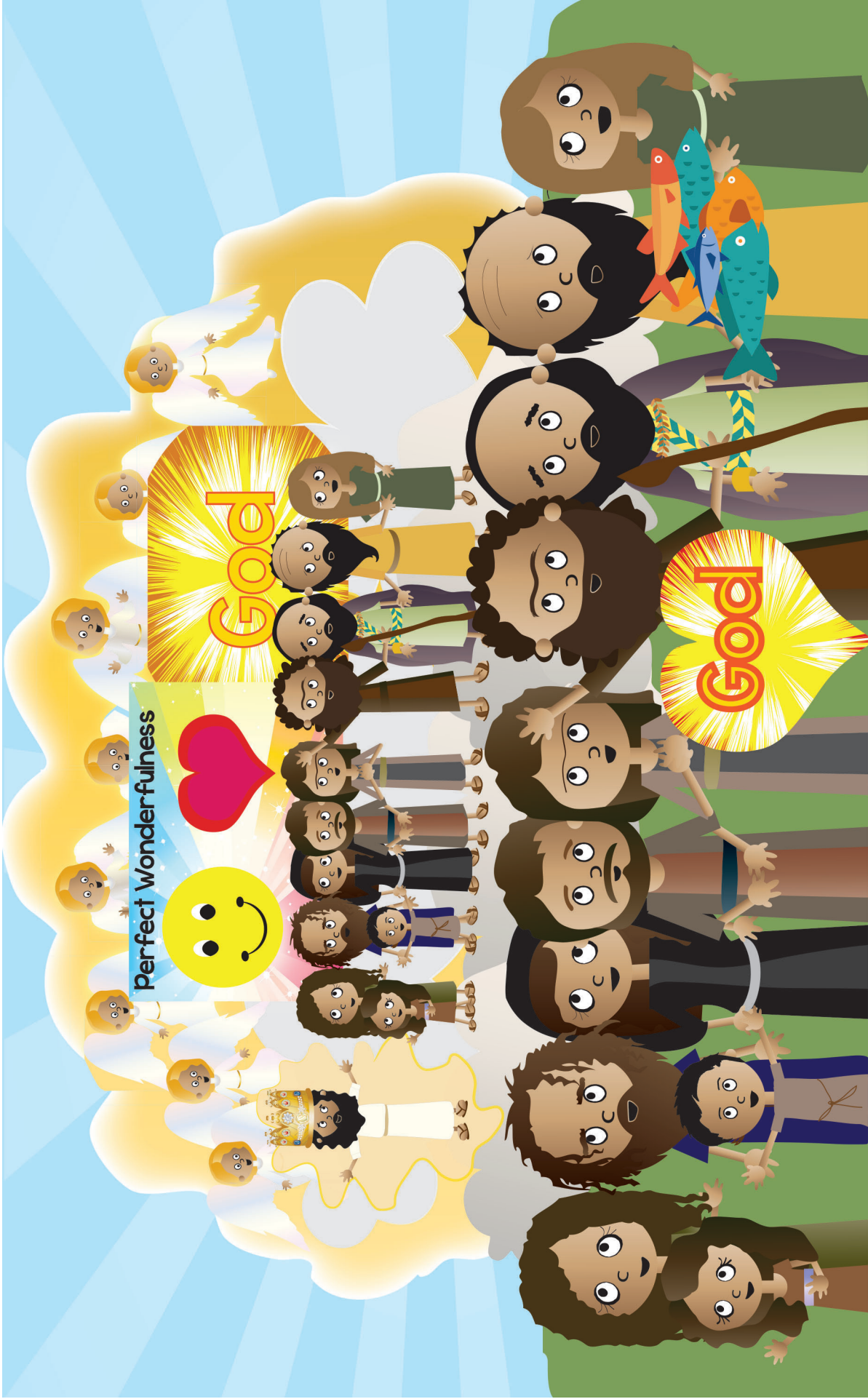

5. This wonderful gift meant God forgave their sins and made them His people. They could know and love God in their hearts. And one day, when they died, they would go live with Him, face-to-face forever. What a wonderful thing the Holy Spirit was doing as those country people listened to Jesus!

6. But God didn't just care about country people. He cared about city people, too.

So, Jesus and His disciples left the country and went to the great city of Jerusalem. And what did Jesus do when He went there? He taught them about God and did amazing things by God's great power, just like He had in the country.



6. But God didn't just care about country people. He cared about city people, too. So, Jesus and His disciples left the country and went to the great city of Jerusalem. And what did Jesus do when He went there? He taught them about God and did amazing things by God's great power, just like He had in the country.

7. All sorts of city people came to Jesus.

Plain, city people, like the people who sold things in the markets, came. Important city people, like the Pharisees (the teachers of God's Word) and government workers, came, too. Poor people, rich people. Good people, bad people. Sick people, healthy people. Fathers, mothers, and children.

They all came to Jesus to hear Him teach about God and do amazing things.



7. All sorts of city people came to Jesus. Plain, city people, like the people who sold things in the markets, came. Important city people, like the Pharisees (the teachers of God's Word) and government workers, came, too. Poor people, rich people. Good people, bad people. Sick people, healthy people. Fathers, mothers, and children. They all came to Jesus to hear Him teach about God and do amazing things.

8. And amazed they certainly were, by what they heard and saw.

“This Jesus is not like any other teacher. What amazing things He says about God. What amazing things He does. He even heals sick people with just His words. Let’s go hear more. Let’s go see more,” they exclaimed.

Soon, big crowds of city people followed Jesus, listening to Him teach about God and watching the amazing things He did by God’s power.



8. And amazed they certainly were, by what they heard and saw. "This Jesus is not like any other teacher. What amazing things He says about God. What amazing things He does. He even heals sick people with just His words. Let's go hear more. Let's go see more," they exclaimed. Soon, big crowds of city people followed Jesus, listening to Him teach about God and watching the amazing things He did by God's power.

q. But you know, Jesus wasn't the only one doing amazing things by God's great power. God, the Holy Spirit was at work, too. He had done amazing things in the country people; and now, He was doing amazing things in the city people, too.

For as some of those city people listened to Jesus talk and watched the amazing things He did, God, the Holy Spirit, worked in their hearts, changing them. He helped them turn away from their sins and trust in Jesus as their Savior. Yes, by His Holy Spirit, God was giving these people the best gift of all: the gift of being saved by faith in Jesus.



9. But you know, Jesus wasn't the only one doing amazing things by God's great power. God, the Holy Spirit was at work, too. He had done amazing things in the country people; and now, He was doing amazing things in the city people, too. For as some of those city people listened to Jesus talk and watched the amazing things He did, God, the Holy Spirit, worked in their hearts, changing them. He helped them turn away from their sins and trust in Jesus as their Savior. Yes, by His Holy Spirit, God was giving these people the best gift of all: the gift of being saved by faith in Jesus.

10. This wonderful gift meant God forgave their sins and made them His people. They could know and love God in their hearts. And one day, when they died, they would go live with Him, face-to-face forever.

What a wonderful thing the Holy Spirit was doing as those city people listened to Jesus!



10. This wonderful gift meant God forgave their sins and made them His people. They could know and love God in their hearts. And one day, when they died, they would go live with Him, face-to-face forever. What a wonderful thing the Holy Spirit was doing as those city people listened to Jesus!

II. Now, among the city people who came to Jesus, was a man named Nicodemus. Nicodemus was NOT a plain, city person. He was one of the most important people in both city AND country!

Nicodemus was one of the head teachers of God's Word. He had spent years and years learning God's Word, then years and years teaching it to others. People looked to Nicodemus to teach them how to live to please God and obey His laws.



II. Now, among the city people who came to Jesus, was a man named Nicodemus. Nicodemus was NOT a plain, city person. He was one of the most important people in both city AND country! Nicodemus was one of the head teachers of God's Word. He had spent years and years learning God's Word, then years and years teaching it to others. People looked to Nicodemus to teach them how to live to please God and obey His laws.

12. But when Jesus came to Jerusalem, Nicodemus just shut his mouth and listened and watched. He could see that Jesus was a teacher unlike any other, a teacher especially sent by God.

When Nicodemus was around Jesus, he didn't feel like a teacher anymore. He felt like a learner. "No one could do the things Jesus does if God had not sent Him," Nicodemus thought.



12. But when Jesus came to Jerusalem, Nicodemus just shut his mouth and listened and watched. He could see that Jesus was a teacher unlike any other, a teacher especially sent by God. When Nicodemus was around Jesus, he didn't feel like a teacher anymore. He felt like a learner. "No one could do the things Jesus does if God had not sent Him," Nicodemus thought.

13. What amazed Nicodemus the most was what was happening in the city people who came to Jesus.

Nicodemus had taught the people to work hard to obey God's good laws. These good works were how to please God, he taught them. People listened to Nicodemus when he taught, but they rarely ever changed.

But when Jesus taught, people were turning away from the bad things they had been doing! They were putting their trust in God! Jesus was teaching, and people were CHANGING!



13. What amazed Nicodemus the most was what was happening in the city people who came to Jesus. Nicodemus had taught the people to work hard to obey God's good laws. These good works were how to please God, he taught them. People listened to Nicodemus when he taught, but they rarely ever changed. But when Jesus taught, people were turning away from the bad things they had been doing! They were putting their trust in God! Jesus was teaching, and people were **CHANGING!**

14. What was going on? What was changing these people? Nicodemus wanted to know. He decided he would go to find Jesus and talk to Him, all by himself.

So, one night, Nicodemus made his way down the dark streets of Jerusalem to the place where Jesus stayed. That night as they talked, Jesus answered Nicodemus' questions.



14. What was going on? What was changing these people? Nicodemus wanted to know. He decided he would go to find Jesus and talk to Him, all by himself. So, one night, Nicodemus made his way down the dark streets of Jerusalem to the place where Jesus stayed. That night as they talked, Jesus answered Nicodemus' questions.

15. Nicodemus was a good Pharisee. He taught the people that only by keeping all of God's good laws could they be God's people and be a part of God's kingdom.

But Nicodemus had it wrong. Now, Jesus would teach the teacher.



15. Nicodemus was a good Pharisee. He taught the people that only by keeping all of God's good laws could they be God's people and be a part of God's kingdom. But Nicodemus had it wrong. Now, Jesus would teach the teacher.

16. “No one can become one of God’s people and part of His kingdom unless they are born again,” Jesus told him.

Nicodemus listened to Jesus’ words. This time, he wasn’t just amazed. He was confused! “Born again? How can this be, Jesus? I’m a full-grown man. Do I have to be born like a baby from a mother again? I don’t understand,” Nicodemus told Jesus.



16. "No one can become one of God's people and part of His kingdom unless they are born again," Jesus told him. Nicodemus listened to Jesus' words. This time, he wasn't just amazed. He was confused! "Born again? How can this be, Jesus? I'm a full-grown man. Do I have to be born like a baby from a mother again? I don't understand," Nicodemus told Jesus.

17. “This is a new birth in your heart, not your body. Only God’s Holy Spirit working in your heart can make you one of God’s people,” Jesus explained. “

The Holy Spirit cleans a heart of sin, just like water cleans away dirt. He helps people repent. That is, He helps them not want to disobey God anymore. He helps them love God and trust in Me as their Savior,” Jesus told Nicodemus.

“And when the Holy Spirit works, He makes such a big change in your heart you become a new person on the inside, like being born again,” Jesus said.

Holy Spirit



17. "This is a new birth in your heart, not your body. Only God's Holy Spirit working in your heart can make you one of God's people," Jesus explained. "The Holy Spirit cleans a heart of sin, just like water cleans away dirt. He helps people repent. That is, He helps them not want to disobey God anymore. He helps them love God and trust in Me as their Savior," Jesus told Nicodemus. "And when the Holy Spirit works, He makes such a big change in your heart you become a new person on the inside, like being born again," Jesus said.

18. “How can this be?” Nicodemus asked, still trying to understand.

“Nicodemus, you are one of the best teachers of God’s Word, yet you don’t understand?” Jesus replied. “This is why God has sent me, His Son, from heaven.”

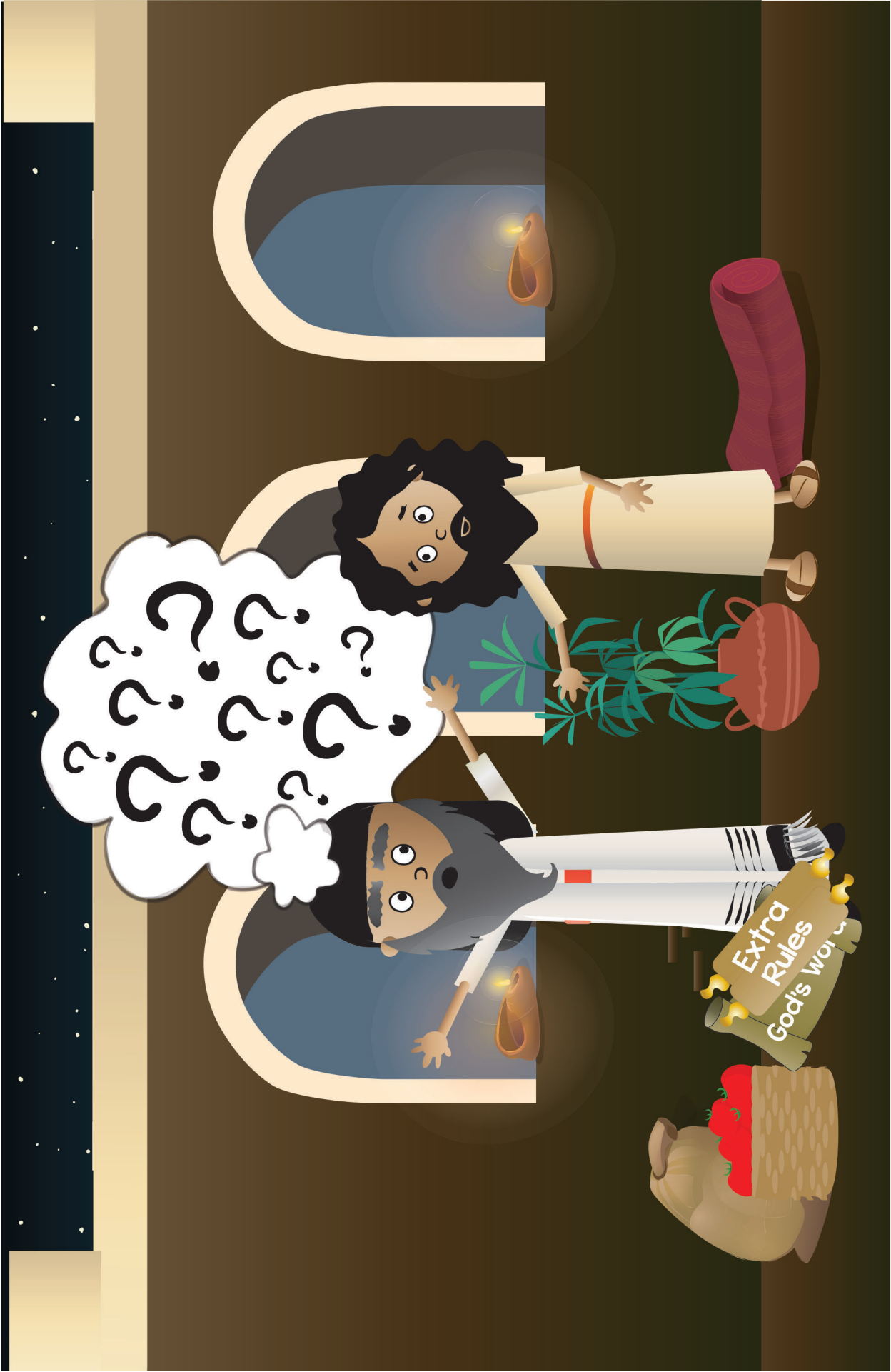

18. "How can this be?" Nicodemus asked, still trying to understand. "Nicodemus, you are one of the best teachers of God's Word, yet you don't understand?" Jesus replied. "This is why God has sent Me, His Son, from heaven."

19. “For God loved the world so much that He sent me to be the Savior. Whoever believes in me won’t be punished by God for their sins. They will have eternal life,” Jesus said.

“I will be lifted up on the cross and will pay for their sins, myself. They will be God’s people. They will live with God in His Kingdom forever,” Jesus explained.

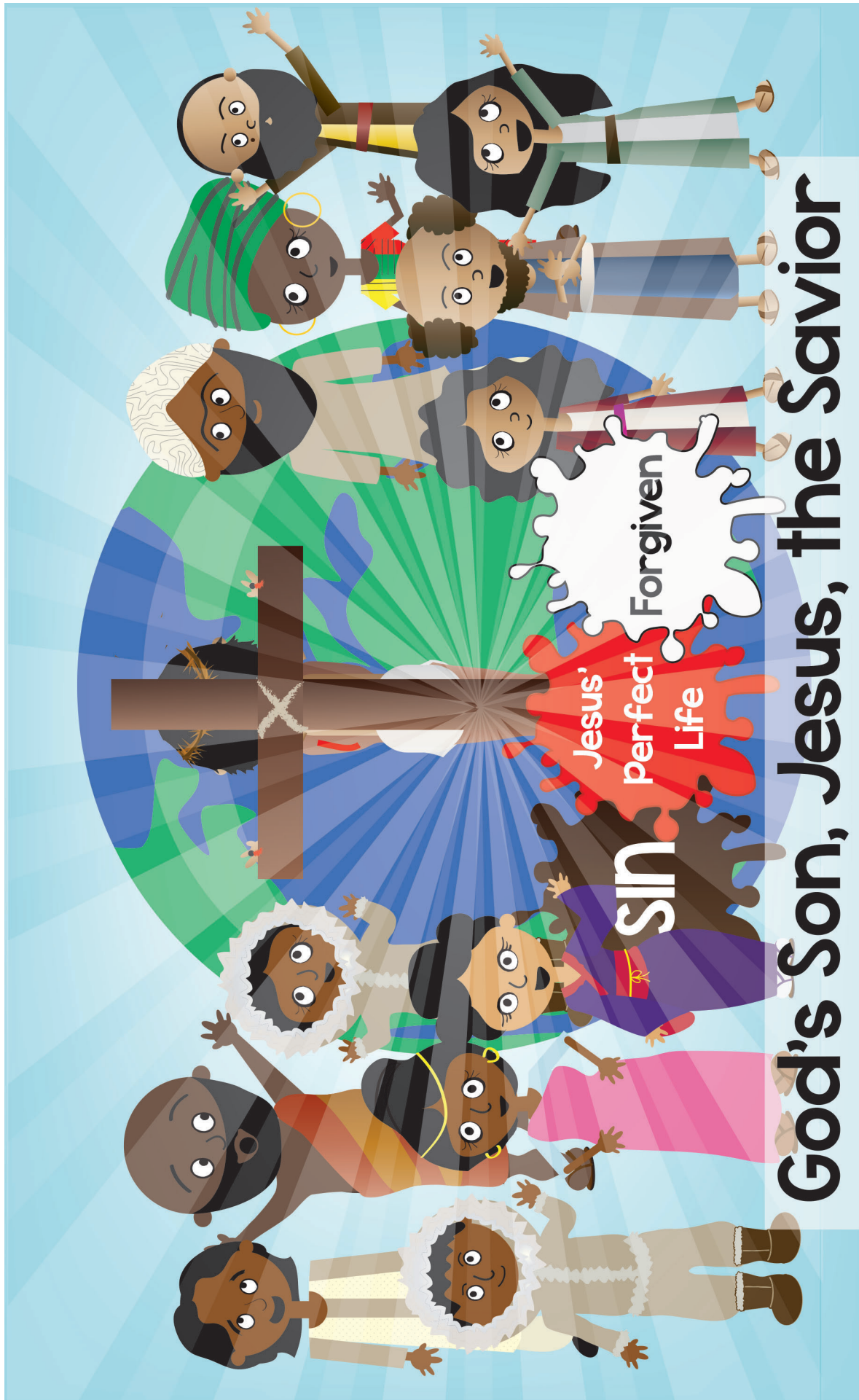

19. "For God loved the world so much that He sent Me to be the Savior. Whoever believes in Me won't be punished by God for their sins. They will have eternal life," Jesus said. "I will be lifted up on the cross and will pay for their sins, Myself. They will be God's people. They will live with God in His Kingdom forever," Jesus explained.

20. Nicodemus had much to think about that night as he went home.

Jesus had taught him so much about God. New things he had never understood before: Jesus is God's Son, the Savior. The Holy Spirit works inside people to help them believe and make them brand-new people. God's people. What big ideas!



20. Nicodemus had much to think about that night as he went home. Jesus had taught him so much about God. New things he had never understood before: Jesus is God's Son, the Savior. The Holy Spirit works inside people to help them believe and make them brand-new people. God's people. What big ideas!

21. Did the Holy Spirit work in Nicodemus' heart as he thought about these things? It seems that He did.

Who was it who helped take down Jesus' body from the cross when He died for the sins of God's people? It was Nicodemus! And who was it who took Jesus' body and buried it in a tomb? It was Nicodemus!

Some say, Jesus' enemies made Nicodemus stop being a head teacher of God's Word because he believed in Jesus. The Bible doesn't tell us that part of Nicodemus' story.



21. Did the Holy Spirit work in Nicodemus' heart as he thought about these things? It seems that He did. Who was it who helped take down Jesus' body from the cross when He died for the sins of God's people? It was Nicodemus! And who was it who took Jesus' body and buried it in a tomb? It was Nicodemus! Some say, Jesus' enemies made Nicodemus stop being a head teacher of God's Word because he believed in Jesus. The Bible doesn't tell us that part of Nicodemus' story.

22. But there's something I DO know for sure. We can ask God's Holy Spirit to work in our hearts right NOW! He can help us to turn away from disobeying God and to trust in Jesus as our own Savior.

Yes, God offers to give you and me the wonderful, free gift of salvation through Jesus. This is how we can become God's people and enjoy Him forever. Ask God to work in your heart. He loves to answer this prayer!



22. But there's something I DO know for sure. We can ask God's Holy Spirit to work in our hearts right NOW! He can help us to turn away from disobeying God and to trust in Jesus as our own Savior. Yes, God offers to give you and me the wonderful, free gift of salvation through Jesus. This is how we can become God's people and enjoy Him forever. Ask God to work in your heart. He loves to answer this prayer!

DDD 11.3 Simple Story Scenes

“The Case of the Surprising, Second Birthday” John 3

SOLVED

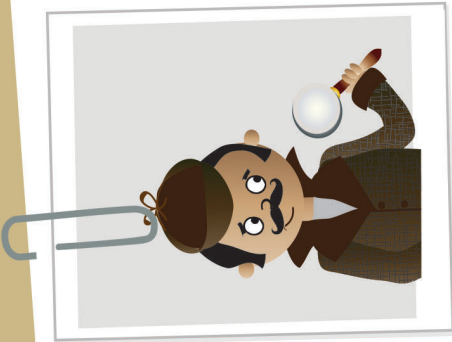

Detective Dan's Listening Assignment #1

1. What special kind of second birthday did Jesus promise to all who trust in him as their Savior? To be a changed person, forgiven of their sins, and one of God's people forever.
2. To whom did Jesus tell about this birthday? What did he find so surprising about it? To Nicodemus. He didn't understand that the Holy Spirit is the One who works inside us and changes our hearts. He is the One who helps us repent and believe, so we can become God's people.

For You and Me:
That special, second birthday wasn't just for important people like Nicodemus. It's for anyone who turns away from their sins and trusts in Jesus as their Savior. Ask the Holy Spirit to work in your heart and help you. He loves to answer these prayers!



Detective Dan's Listening Assignment #2

Titus 3:5, ESV

“He saved us, not because of works done by us in righteousness, but according to his own mercy, by the washing of regeneration and renewal of the Holy Spirit.”

1. What kind of special, second birthday does God give to each of His people? To be made a new person inside their heart. God forgives their sins and helps them trust in Jesus as their Savior.
2. Who does God send to work in their hearts and give them this special, second birthday? The Holy Spirit.

For You and Me:
That special, second birthday that God gave to His people long ago is something He still gives to people today. How? When they turn away from their sins and trust in Jesus as their Savior. Ask the Holy Spirit to come and work in your heart and help you do this. He loves to answer this prayer!

DDD 11.3 Simple Story Scenes

**How Can We Be Saved?
It Is God's Free Gift...**

When the Holy Spirit Works in Our Hearts!

The Gospel

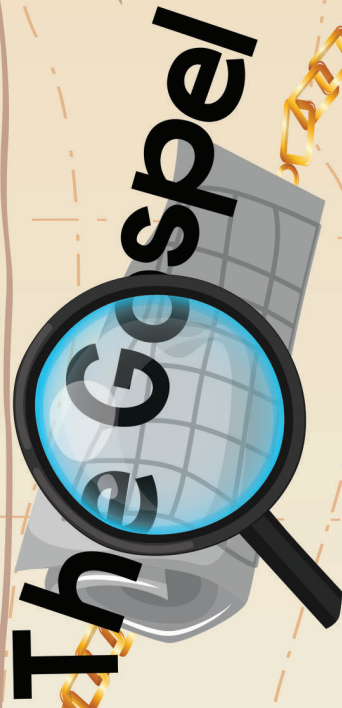

We all have chosen to disobey God. Our hearts are dead and empty of love for Him and His good ways. We would never choose to love God on our own.

We deserve God's punishment, but God has sent us a Savior-- His Son, Jesus. Jesus lived a perfect life and offered it up as the full payment for the sins of God's people when He died on the cross. On Day Three, Jesus rose from the dead. He had beaten sin and death for God's people.

Now, we can become God's people when we turn away from our sins and trust in Jesus as our Savior. We can ask God to send His Holy Spirit to work in our hearts and help us. God loves to answer this prayer!



DDD 11.3 Simple Story Scenes

A Prayer

A God, we praise You for being the Changer of the hearts of sinful people, like us.

C God, we confess that we are all sinners. We have hard hearts that are slow to believe, love, and obey You. We need Jesus to save us!

T Thank You for sending Your Holy Spirit to work in the hearts of people like us, so we can know You, love You, and live for You. You give us what we need but could never get on our own.

S God, send the Holy Spirit to work in our hearts. Give us faith as we hear Your Word, the Bible. Help us to turn away from our sins and trust in Jesus as our Savior. Make us new creations! Give us the new birth! We want to know You and live for You!

In Jesus' name we pray. Amen.



DDD 11.3 Simple Story Scenes

DEEP DOWN DETECTIVES



**Take-Home
Sheets**

**CAN YOU GUESS BIBLE TRUTHI:
How Can We Be Saved?
It Is God's Free Gift...**

When We Tell God Our

**-----

and Turn Away from Them!**

**HINT: What is the Bible word for disobeying God
and His good laws? It starts with an "s"
and it rhymes with "ends."**

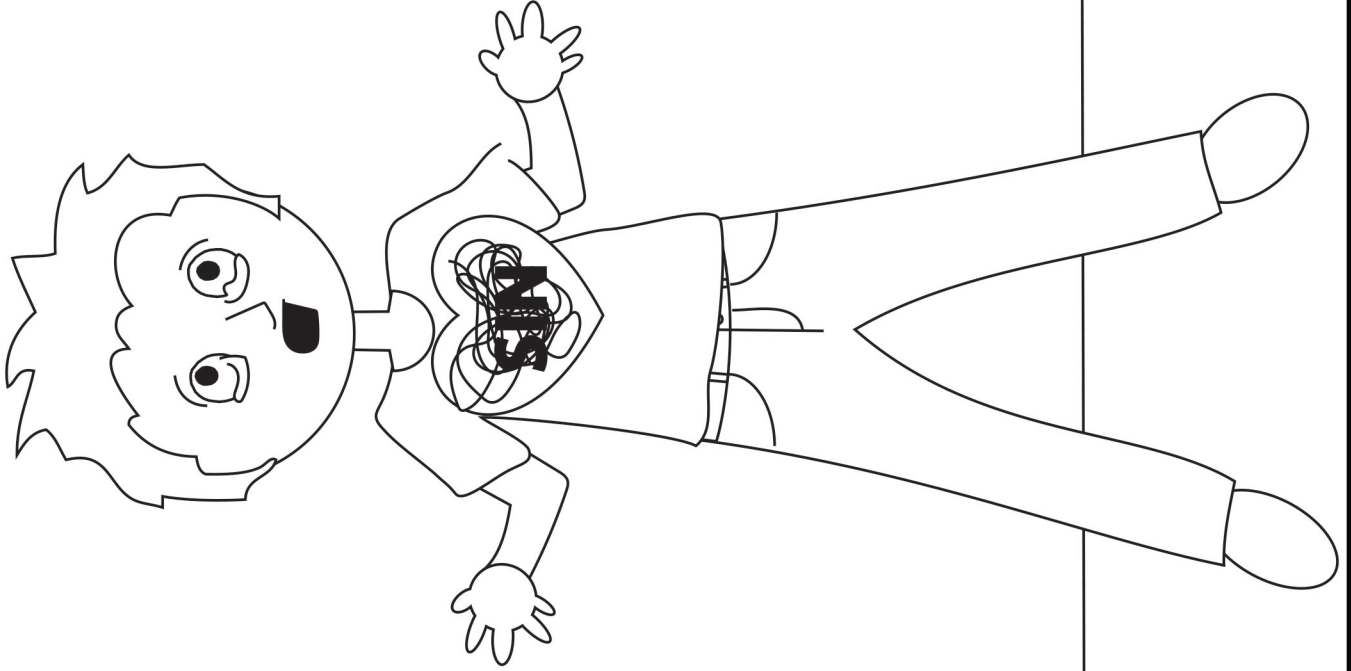

Deep Down Detective Devotion: Unit 11, Bible Truth 1, Lesson 1



Big Question 11: How Can We Be Saved?

Answer: It Is God's Free Gift... When We Tell God Our Sins and Turn Away from Them!

Bible Truth 1 Meaning

We are all sinners who disobey God. We hear God's laws from the Bible, and we know that we have broken them. We hear how we are supposed to love God and His good ways, and we know that we do not. We hear about God's punishment for sin, and we know that we deserve it. But God is so merciful! He has provided a way to save us from His punishment. How? God wants us to tell (confess) our sins to Him and ask for His forgiveness through His Son, Jesus, who died on the cross to take the punishment for the sins of God's people. And, God wants us to turn away from a life of disobeying Him and ask Him to help us to live for Him instead (that's what it means to repent of our sins.) If we do these things, God promises to forgive our sins and make us His very own people. We will get to know Him in our hearts by His Holy Spirit now. And one day, when we die, we will go to live perfectly happily with Him forever.

How do I know this is true? The Bible tells me so!

"If we say we have no sin, we deceive ourselves, and the truth is not in us. If we confess our sins, he is faithful and just to forgive us our sins and to cleanse us from all unrighteousness." --1 John 1:8-9, ESV

Some Questions for You

1. Who are sinners? *We all are.*
2. When we hear God's big rules, His laws, what do we know? *That we have broken them.*
3. When we hear we are supposed to love God and His good ways, what do we know? *That we do not love Him or His good ways as we should.*
4. When we hear about God's punishment for sin what do we know? *That we deserve it.*
5. Does God want us to have His punishment for sin? *No, He does not. He wants to save us.*
6. How can we be saved? *By telling Him our sins, turning away from wanting to disobey Him; and trusting in Jesus as our Savior.*
7. What does God promise to do when we trust Jesus as our Savior? *Forgive our sins, make us His very own people, and give us special closeness with Him now and forever.*

Let's Pray!

- A** God, we praise You for being faithful and just, and able to forgive our sins.
- C** God, we confess that we are all sinners who need You to save us. We can never be acceptable to You on our own. We need Jesus to save us!
- T** Thank You, God, for being willing to forgive all our sins, when we confess them, turn away from them, and trust in Jesus as our Savior.
- S** God, work in our hearts. Show us our sins and our need for Jesus to save us. Help us to confess our sins to You and turn away from them. Help us to trust in Jesus as our Savior. Be our Heavenly Father! Make us Your adopted children who love You and whom You will love forever. In Jesus' name we pray, Amen.

Let's Sing about What We're Learning!

Big Q & A 11 Song from *Deep Down Detectives ESV Songs 11, track 12*

(adapted version of "Here We Go Looby Loo")

How can we be saved?
How can we be saved?
How can we be saved?
It is God's free gift!

Big Question 11 Action Rhyme Song from *Deep Down Detectives ESV Songs 11, track 13*

Refrain:

How can we be saved?
How can we be saved?
How can we be saved?
It's God's free gift.
How can we be saved?
How can we be saved?
How can we be saved?
How can we be saved?
It's God's free gift through Christ.

Verse 1

I disobey God, I need a Savior,
You disobey God, You need a Savior,
We all disobey God, We need a Savior.
To save us from our sins. *Refrain*

Verse 2

Jesus, He paid the price, the perfect sacrifice,
On the cross, gave His life,
Bought us eternal life,
Takes away all our sin,
Makes our hearts clean within,
When we repent and believe in Him. *Refrain*

**"If we say we have no sin, we deceive ourselves, and the truth is not in us.
If we confess our sins, he is faithful and just to forgive us our sins
and to cleanse us from all unrighteousness -- 1 John 1:8-9, ESV**

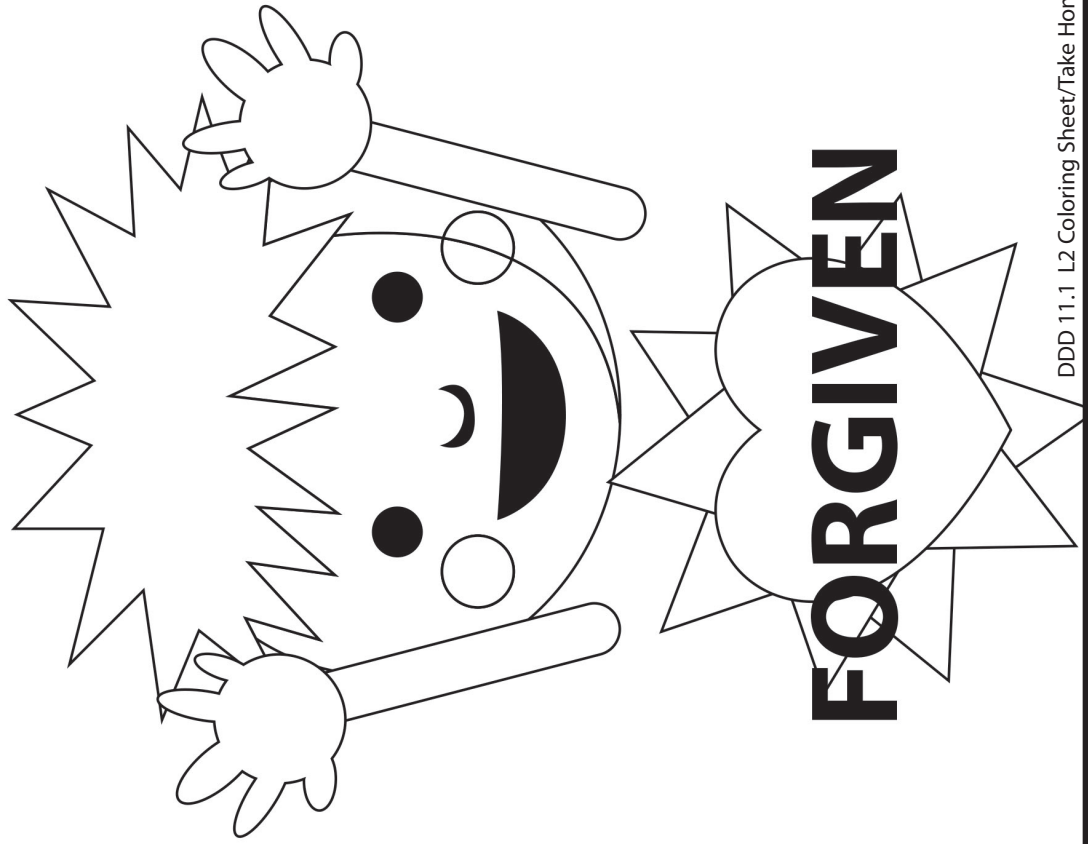
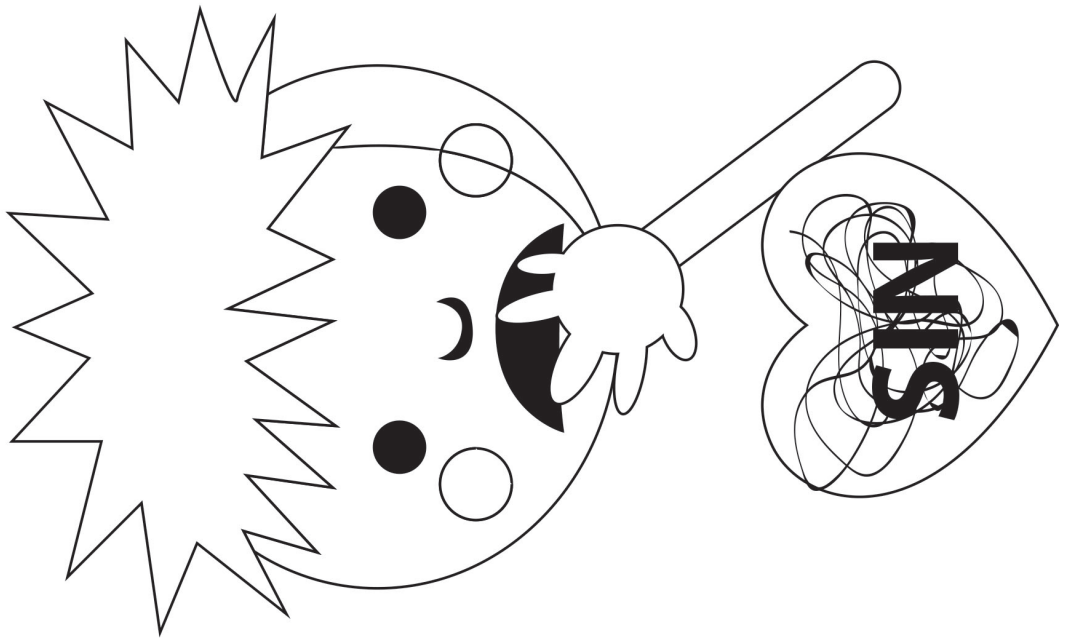

Deep Down Detective Devotion: Unit 11, Bible Truth 1, Lesson 2



Big Question 11: How Can We Be Saved?

Answer: God's Laws Are Perfect... When We Tell God Our Sins and Turn Away from Them!

How do I know this is true? The Bible tells me so!

"If we say we have no sin, we deceive ourselves, and the truth is not in us. If we confess our sins, he is faithful and just to forgive us our sins and to cleanse us from all unrighteousness." --1 John 1:8-9, ESV

Learn a Little: "If we confess our sins, he is faithful to forgive our sins."

Meaning

This verse reminds us that we are all sinners. We deceive ourselves if we think we are not. But, the good news is, that if we admit we are sinners and confess our sins to God, He is faithful and just and will forgive us our sins and save us through Jesus.

Some Questions for You

1. If we say we are without sin, who do we deceive (who are we fooling)? *Ourselves.*
2. Who is faithful to forgive our sins, if we confess them to Him? *God is.*
3. What does God purify us from when we confess our sins to Him? *All unrighteousness. That means He treats us as if we have never disobeyed Him.*
4. What do we need to do for God to forgive our sins? *We need to confess our sins to God, telling Him that we know that we have disobeyed Him and deserve His punishment. We need to turn away from our sins and trust in Jesus as our Savior. God promises to forgive the sins of all who do!*

Let's Pray!

- A** God, we praise You for being faithful and just, and able to forgive our sins.
- C** God, we confess that we are all sinners who need You to save us. We can never be acceptable to You on our own. We need Jesus to save us!
- T** Thank You, God, for being willing to forgive all our sins, when we confess them, turn away from them, and trust in Jesus as our Savior.
- S** God, work in our hearts. Show us our sins and our need for Jesus to save us. Help us to confess our sins to You and turn away from them. Help us to trust in Jesus as our Savior. Be our Heavenly Father! Make us Your adopted children who love You and whom You will love forever. In Jesus' name we pray, Amen.

Let's Sing Our Bible Verse!

If We Say We Have No Sin 1 John 1:8-9

from Deep Down Detectives ESV Songs 11, tracks 17

If we say we have no sin,
If we say we have no sin,
If we say we have no sin,
We deceive ourselves,
And the truth is not in us.

But...If we confess our sins...
He is faithful and just to forgive us our sins,
Faithful and just to forgive us our sins,
Faithful and just to forgive us our sins,
And to cleanse us from,
All unrighteousness.

First John One, verses eight and nine.

Go to the Deep Down Detectives Parent Resources for Unit 11 to get the Bible story and many more resources and songs for this unit at praisefactory.org

DDD BQ11 BT 1 L2 Coloring Sheet/Take Home pg2

Which four of these clues belong in our story? Which two do not? Put an X in the boxes of the four that belong.

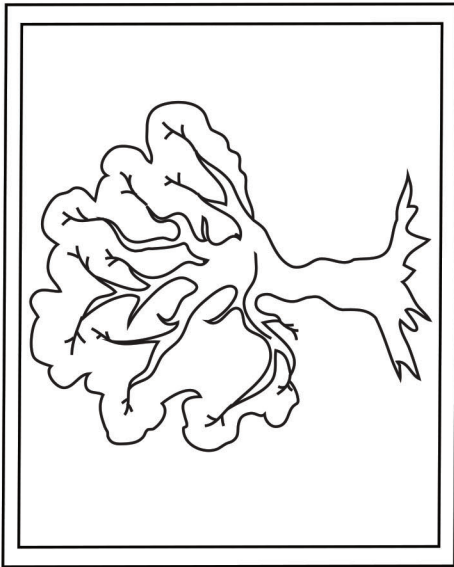

A Tree

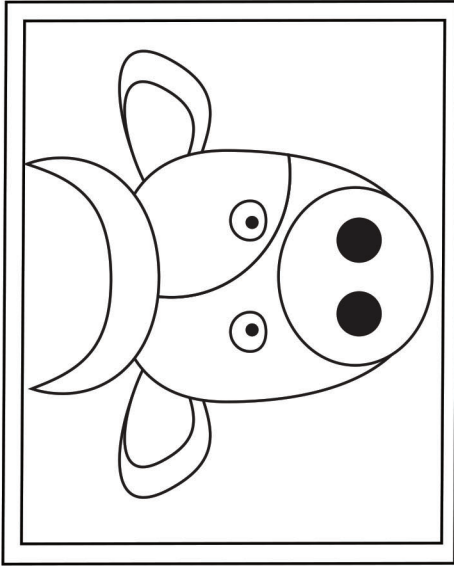

A Cow

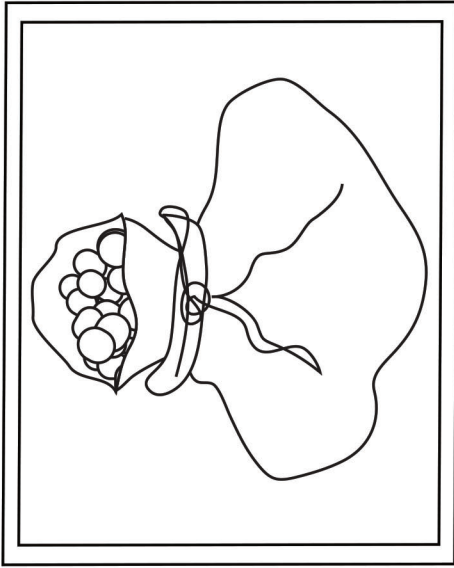

A Bag of Money

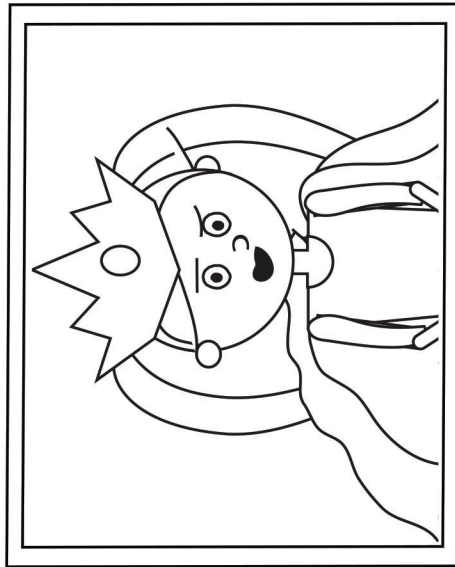

A King

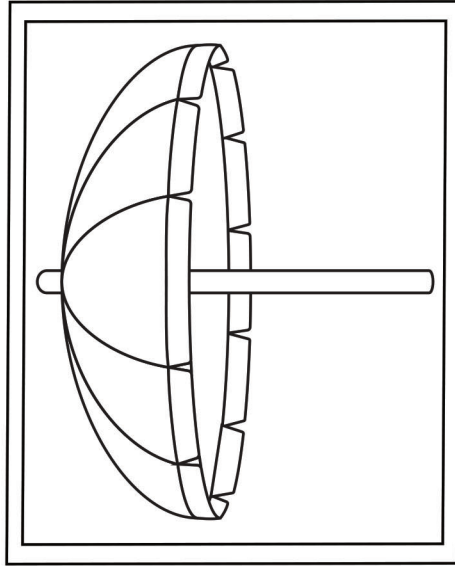

An Umbrella

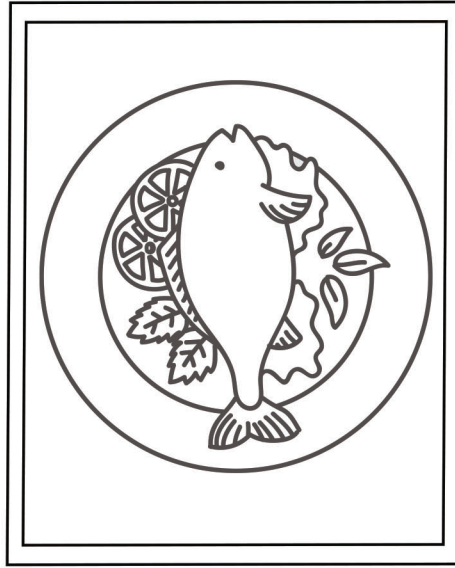

Yummy Food

Answer: The tree, the bag of money, the king and the yummy food belong. The cow and the umbrella do not.

Deep Down Detective Devotion: Unit 11, Bible Truth 1, Lesson 3



Big Question 11: How Can We Be Saved?

Answer: It Is God's Free Gift... When We Tell God Our Sins and Turn Away from Them!

Bible Truth 1 Meaning

We are all sinners who disobey God. We hear God's laws from the Bible, and we know that we have broken them. We hear how we are supposed to love God and His good ways, and we know that we do not. We hear about God's punishment for sin, and we know that we deserve it. But God is so merciful! He has provided a way to save us from His punishment. How? God wants us to tell (confess) our sins to Him and ask for His forgiveness through His Son, Jesus, who died on the cross to take the punishment for the sins of God's people. And, God wants us to turn away from a life of disobeying Him and ask Him to help us to live for Him instead (that's what it means to repent of our sins.) If we do these things, God promises to forgive our sins and make us His very own people. We will get to know Him in our hearts by His Holy Spirit now. And one day, when we die, we will go to live perfectly happily with Him forever.

How do I know this is true? The Bible tells me so!

"If we say we have no sin, we deceive ourselves, and the truth is not in us. If we confess our sins, he is faithful and just to forgive us our sins and to cleanse us from all unrighteousness." --1 John 1:8-9, ESV

Some Questions for You

1. What did Zacchaeus have? *Just about everything that money could buy.*
2. What did Zacchaeus want that money couldn't buy? *He wanted God's forgiveness.*
3. What kinds of bad things did Zacchaeus do to get all his money? *Good food, a nice house, beautiful clothes, and just about whatever else he wanted.*
4. What special place was Zacchaeus not allowed to go to because of the bad things he did? *The place to worship God.*
5. Why did Zacchaeus climb the tree? *He was too short to see Jesus and no one would make a place for him along the road.*
6. What did Jesus tell Zacchaeus to do? *To come down from the tree and take Him to his house to be his guest.*
7. What did Jesus offer Zacchaeus? *Forgiveness from his sins.*
8. What did Zacchaeus do that showed that he really had turned away from his sins and trusted in Jesus as his Savior? *He promised to pay back all the people whose money he had wrongly taken.*
9. Who worked in Zacchaeus' heart so that he would be changed? *The Holy Spirit.*
10. How can we have God's forgiveness for our sins? *By turning away from our sins and trusting in Jesus as our Savior.*

Let's Pray!

- A** God, we praise You for being faithful and just, and able to forgive our sins.
- C** God, we confess that we are all sinners who need You to save us. We can never be acceptable to You on our own. We need Jesus to save us!
- T** Thank You, God, for being willing to forgive all our sins, when we confess them, turn away from them, and trust in Jesus as our Savior.
- S** God, work in our hearts. Show us our sins and our need for Jesus to save us. Help us to confess our sins to You and turn away from them. Help us to trust in Jesus as our Savior. Be our Heavenly Father! Make us Your adopted children who love You and whom You will love forever. In Jesus' name we pray, Amen.

Let's Praise God Right Now!

Big Question 11 Hymn: Grace that Is Greater than All Our Sin from *Deep Down Detectives* ESV Songs 11, track 15

Verse 1

Grace, grace, God's grace,
Grace that will pardon and cleanse within;
Grace, grace, God's grace,
Grace that is greater than all our sin.

Words: Julie H. Johnston Music: Daniel B. Towner

Go to the *Deep Down Detectives* Parent Resources for Unit 11 to get the Bible story and many more resources and songs for this unit at praisefactory.org

Big Question 11 Praise Song: Blessed Be the Name from *Deep Down Detectives* ESV Songs 11, track 16

All praise to Him who reigns above In majesty supreme. Who gave His Son for man to die, That He might man redeem!	Blessed be the name, Blessed be the name, Blessed be the name of the Lord; Blessed be the name, Blessed be the name, Blessed be the name of the Lord.
--	--

CAN YOU GUESS BIBLE TRUTH 2:

How Can We Be Saved?

It Is God's Free Gift...

When We Trust in

As Our Own Savior!"

HINT: What's the name of God's Son? His name starts with a "J" and it sounds like "sneezes."

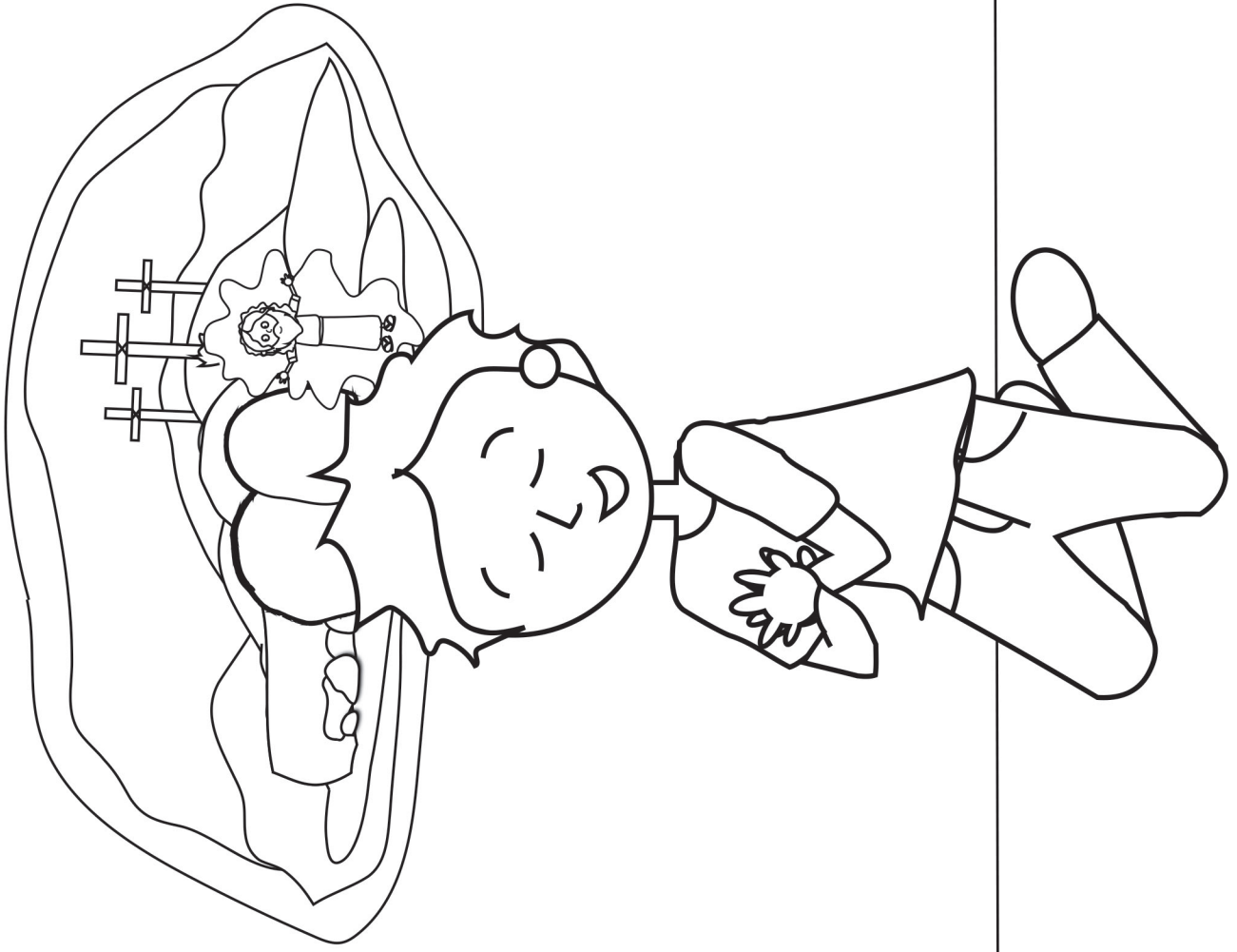

Deep Down Detective Devotion: Unit 11, Bible Truth 2, Lesson 1



Big Question 11: How Can We Be Saved?

Answer: It Is God's Free Gift... When We Trust in Jesus as Our Own Savior!

Bible Truth 2 Meaning

God created us to love and obey Him, but we have all chosen to disobey Him. That's why we all deserve His punishment, instead of His friendship. Our sins separate us from Him. God would be fair to punish us for our sins, but He has chosen to be so kind to us. He offers to forgive our sins and make us His people through Jesus, His Son. Jesus came to earth and lived a perfect life. He never, ever disobeyed God. Then on the cross, Jesus chose to offer up His perfect life as the perfect sacrifice for the sins of God's people. He took the punishment for sins they deserved to save them from their sins. Jesus died on the cross and was buried in a grave, but He didn't stay there. He had beaten sin and death for God's people. He rose from the dead in victory, never to die again! Now, all who turn away from their sins and trust in Jesus as their Savior, are forgiven their sins. They are God's people who know Him in their hearts by His Holy Spirit. And when they die, they will go to live perfectly happy with Him forever. This wonderful, free gift can be ours, too, when we turn away from our sins and trust in Jesus as our own Savior. Isn't that wonderful news!

How do I know this is true? The Bible tells me so!

"If you confess with your mouth that Jesus is Lord and believe in your heart that God raised him from the dead, you will be saved. For with the heart one believes and is justified, and with the mouth one confesses and is saved."

--Romans 10: 9-10, ESV

Some Questions for You

1. God created us to do what? *To love and obey Him perfectly.*
2. Do we love and obey God perfectly? *No, we do not. We have all chosen to disobey Him.*
3. Do we deserve special closeness with God? *No.*
4. What do we deserve from God? *His punishment for our sins.*
5. What does God give His people that is better than they deserve? *He sent Jesus to take the punishment for their sins so that they could be saved.*
6. How can we become God's people and receive the free gift of salvation? *By turning away from our sins and trusting in Jesus as our Savior. God loves to answer this prayer!*

Let's Pray!

- A** God, we praise You for being good and just. We honor You as the One we should all obey.
- C** God, we confess that we are all sinners who have disobeyed You. We know that we can never deserve to be Your people by good things we do. We need a Savior!
- T** Thank You, God, for sending Jesus as the Savior we need. Thank You that He made the way for us to become Your people with His perfect life given as the full payment for the sins of God's people.
- S** God, work in our hearts. Help us to confess our sins to You and turn away from them. Help us to trust in Jesus as our Savior. Help us to know and love You. Help us to live for You. In Jesus' name we pray, Amen.

Let's Sing about What We're Learning!

Big Q & A 11 Song from *Deep Down Detectives* ESV Songs 11, track 12
(adapted version of "Here We Go Looby Loo")

How can we be saved?
How can we be saved?
How can we be saved?
It is God's free gift!

Big Question 11 Action Rhyme Song

 from *Deep Down Detectives* ESV Songs 11, track 13

Refrain:

How can we be saved?
How can we be saved?
How can we be saved?
It's God' free gift.
How can we be saved?
How can we be saved?
How can we be saved?
How can we be saved?
It's God's free gift through Christ.

Verse 1

I disobey God, I need a Savior,
You disobey God, You need a Savior,
We all disobey God, We need a Savior.
To save us from our sins. *Refrain*

Verse 2

Jesus, He paid the price, the perfect sacrifice,
On the cross, gave His life,
Bought us eternal life,
Takes away all our sin,
Makes our hearts clean within,
When we repent and believe in Him. *Refrain*

Go to the *Deep Down Detectives* Parent Resources for Unit 11 to get the Bible story and many more resources and songs for this unit at praisefactory.org

DDD BQ11 BT 2 L1 Coloring Sheet/Take Home pg2

**“If you confess with your mouth that Jesus is Lord
and believe in your heart that God raised him from the dead,
you will be saved.**

**For with the heart one believes and is justified,
and with the mouth one confesses and is saved.”**

--Romans 10:9-10, ESV

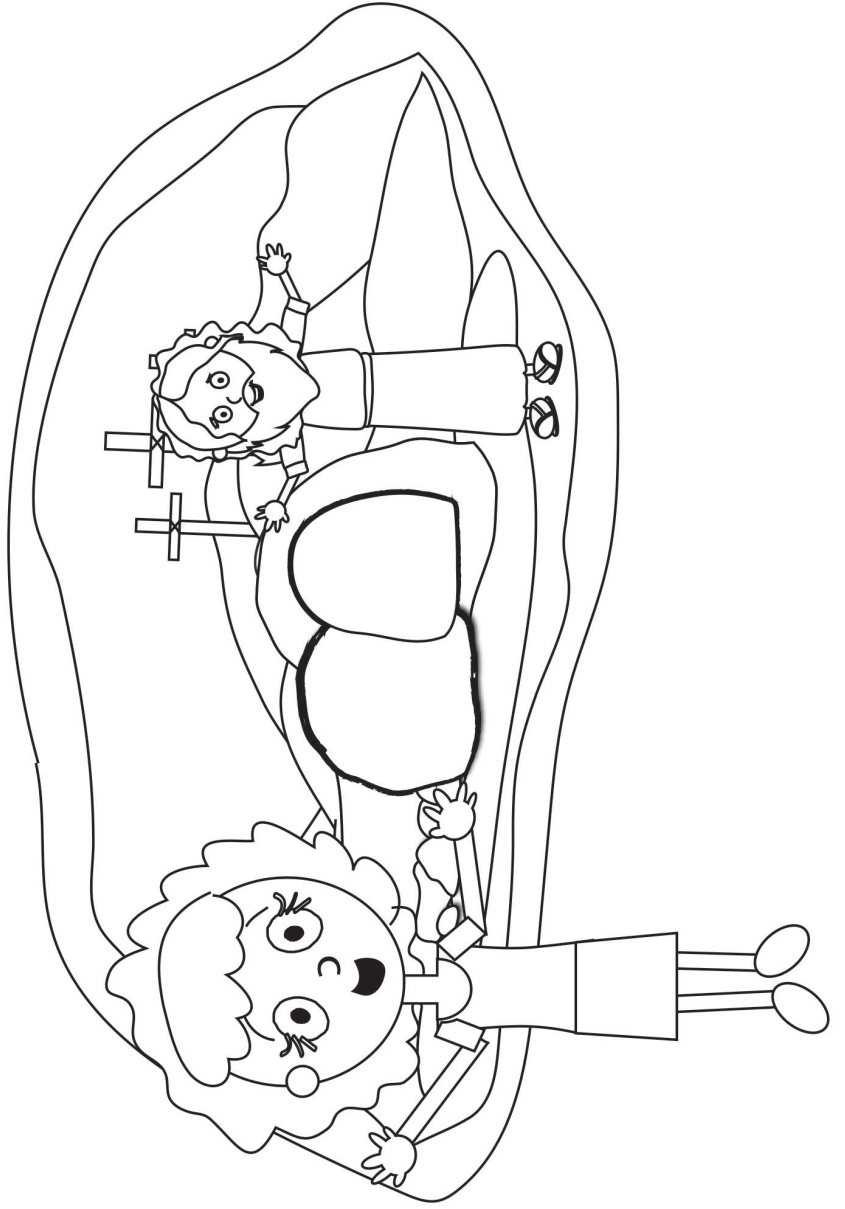
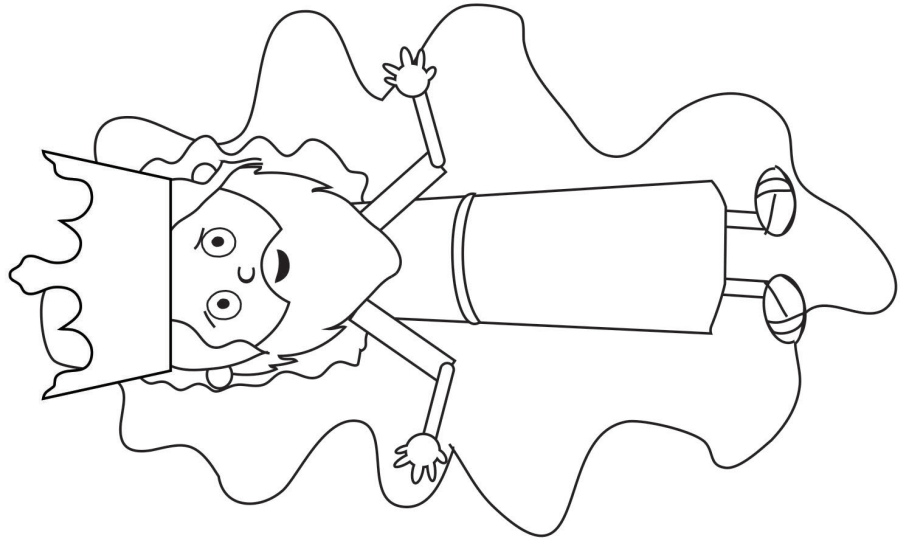

Deep Down Detective Devotion: Unit 11, Bible Truth 2, Lesson 2



Big Question 11: How Can We Be Saved?

Answer: It Is God's Free Gift... When We Trust in Jesus as Our Own Savior!

How do I know this is true? The Bible tells me so:

"If you confess with your mouth that Jesus is Lord and believe in your heart that God raised him from the dead, you will be saved. For with the heart one believes and is justified, and with the mouth one confesses and is saved."

--Romans 10:9-10, ESV

Learn a Little: "If you confess Jesus is Lord and believe that God raised him from the dead, you will be saved."

Meaning:

To believe something in your heart is to think that something is true. To confess something is to tell others what you think is true. Christians are those who believe in their hearts that Jesus is the Son of God, who died on the cross to save God's people from their sins. They believe that He rose from the dead on the third day, showing that He had beaten sin and death for them. They love telling this good news to others that they might believe and be saved, too. We must believe in our own hearts that He is our Savior and be willing to confess to others that He is our Lord, if we are to be saved, too!

Some Questions for You

1. What does it mean to believe something in your heart? *To think that it is true.*
2. What does it mean to confess something? *To tell others what you think is true.*
3. Who do Christians believe in their heart is Lord? What does that mean? *They believe Jesus is Lord. They believe He is the Son of God who we should all obey.*
4. What amazing thing do they believe Jesus did? *He died on the cross for the sins of God's people and on the third day, God raised Him from the dead. He beat sin and death for God's people!*
5. How can Jesus become our Savior? *When we turn from our sins and trust in Him as our Savior.*

Let's Pray!

- A** God, we praise You for being good and just. We honor You as the One we should all obey.
- C** God, we confess that we are all sinners who have disobeyed You. We know that we can never deserve to be Your people by good things we do. We need a Savior!
- T** Thank You, God, for sending Jesus as the Savior we need. Thank You that He made the way for us to become Your people with His perfect life given as the full payment for the sins of God's people.
- S** God, work in our hearts. Help us to confess our sins to You and turn away from them. Help us to trust in Jesus as our Savior. Help us to know and love You. Help us to live for You. In Jesus' name we pray, Amen.

Let's Sing Our Bible Verse!

If You Confess with Your Mouth: Romans 1:9-10

from Deep Down Detectives ESV Songs 11, track 19

If you confess, with your mouth, "Jesus is Lord,"
And believe in your heart,
That God raised Him from the dead,
You will be saved, you will be saved.
For with the heart, one believes and is justified.

If you confess, with your mouth, "Jesus is Lord,"
And believe in your heart,
That God raised Him from the dead,
You will be saved, you will be saved.
For with the mouth, one confesses and is saved.
Romans Ten: nine through ten.

Go to te Deep Down Detectives Parent Resources for Unit 11 to get the Bible story and many more resources and songs for this unit at praisefactory.org

Which four of these clues belong in our story? Which two do not? Put an X in the boxes of the four that belong.

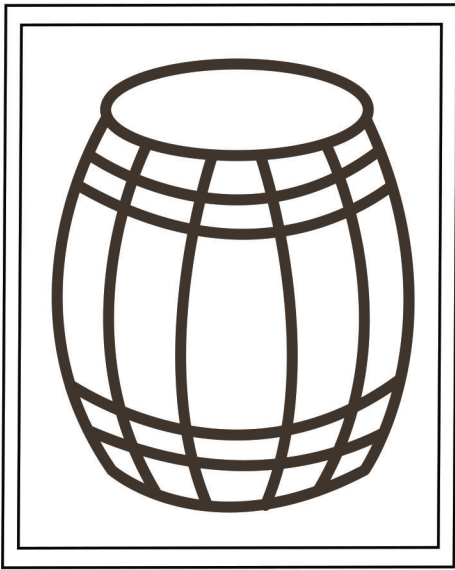

A Barrel

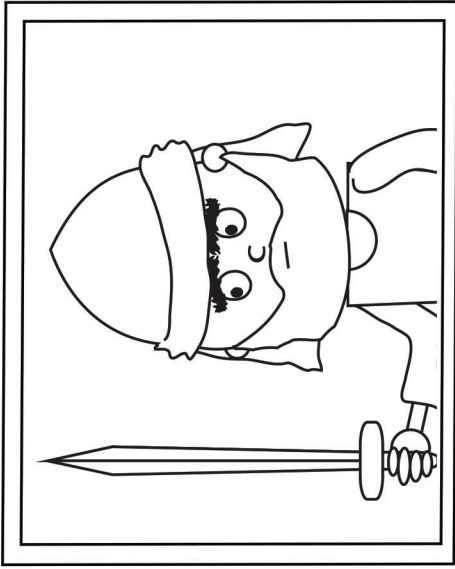

A Soldier

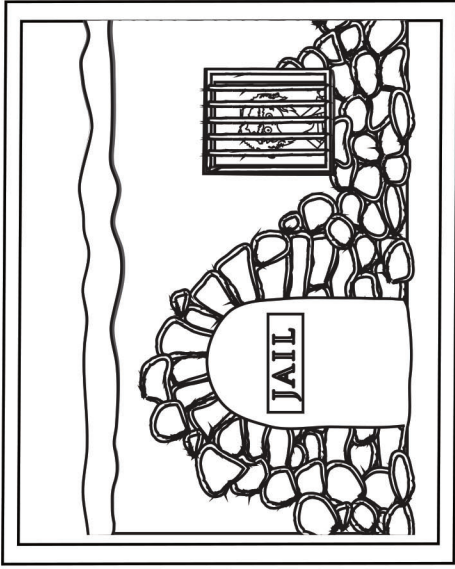

A Jail

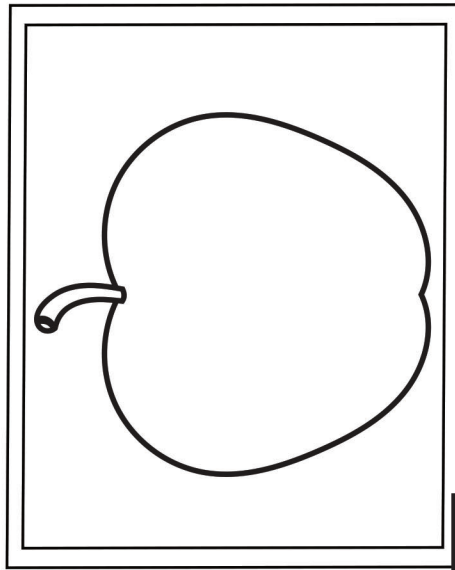

An Apple

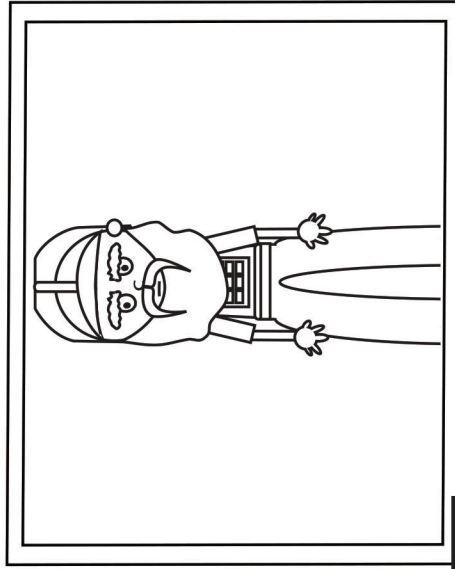

A High Priest

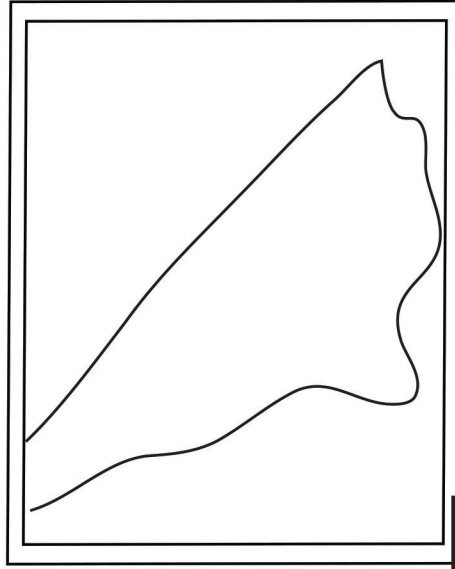

A Bright Light

Answer: The soldier, the jail, the high priest and the bright light belong. The barrel and the apple do not.

Deep Down Detective Devotion: Unit 11, Bible Truth 2, Lesson 3



Big Question 11: How Can We Be Saved?

Answer: It Is God's Free Gift... When We Trust in Jesus as Our Own Savior!

Bible Truth 2 Meaning

God created us to love and obey Him, but we have all chosen to disobey Him. That's why we all deserve His punishment, instead of His friendship. Our sins separate us from Him. God would be fair to punish us for our sins, but He has chosen to be so kind to us. He offers to forgive our sins and make us His people through Jesus, His Son. Jesus came to earth and lived a perfect life. He never, ever disobeyed God. Then on the cross, Jesus chose to offer up His perfect life as the perfect sacrifice for the sins of God's people. He took the punishment for sins they deserved to save them from their sins. Jesus died on the cross and was buried in a grave, but He didn't stay there. He had beaten sin and death for God's people. He rose from the dead in victory, never to die again! Now, all who turn away from their sins and trust in Jesus as their Savior, are forgiven their sins. They are God's people who know Him in their hearts by His Holy Spirit. And when they die, they will go to live perfectly happy with Him forever. This wonderful, free gift can be ours, too, when we turn away from our sins and trust in Jesus as our own Savior. Isn't that wonderful news!

How do I know this is true? The Bible tells me so:

"If you confess with your mouth that Jesus is Lord and believe in your heart that God raised him from the dead, you will be saved. For with the heart one believes and is justified, and with the mouth one confesses and is saved."

--Romans 10:9-10, ESV

Some Questions for You

1. What did Jesus' followers do that made Saul so mad? *They told everyone that Jesus died on the cross and rose from the dead to save God's people. They told everyone to turn away from their sins and trust in Jesus as their Savior.*
2. What did Saul tell Jesus' followers to do? *To stop telling people about Jesus.*
3. Why didn't Jesus' followers stop telling others about Jesus? *Because they wanted others to be forgiven their sins and know God.*
4. What did Saul do to Jesus' followers? *He found them, hurt them and had them put in jail.*
5. Why did Jesus' followers move to other cities? *So that Saul couldn't hurt them and so they could tell more people about Jesus.*
6. What happened to Saul when he went to Damascus to get rid of Jesus' followers who had moved there? *Jesus appeared to him on the road. He became blind and was taken to Damascus. He turned away from his sins and trusted in Jesus as his Savior.*
7. What did Saul start doing after he became a follower of Jesus? *He went and told everyone the good news of Jesus, too.*
8. How can we be saved from our sins, like Saul was? *By turning away from our sins and trusting in Jesus as our Savior.*

Let's Pray!

- A** God, we praise You for being good and just. We honor You as the One we should all obey.
- C** God, we confess that we are all sinners who have disobeyed You. We know that we can never deserve to be Your people by good things we do. We need a Savior!
- T** Thank You, God, for sending Jesus as the Savior we need. Thank You that He made the way for us to become Your people with His perfect life given as the full payment for the sins of God's people.
- S** God, work in our hearts. Help us to confess our sins to You and turn away from them. Help us to trust in Jesus as our Savior. Help us to know and love You. Help us to live for You. In Jesus' name we pray, Amen.

Let's Praise God Right Now!

Big Question 11 Hymn: Grace that Is Greater than All Our Sin from *Deep Down Detectives* ESV Songs 11, track 15

Verse 1

Grace, grace, God's grace,
Grace that will pardon and cleanse within;
Grace, grace, God's grace,
Grace that is greater than all our sin.

Words: Julie H. Johnston Music: Daniel B. Towner

Go to the *Deep Down Detectives* Parent Resources for Unit 11 to get the Bible story and many more resources and songs for this unit at praisefactory.org

Big Question 11 Praise Song: Blessed Be the Name from *Deep Down Detectives* ESV Songs 11, track 16

All praise to Him who reigns above	Blessed be the name,
In majesty supreme.	Blessed be the name,
Who gave His Son for man to die,	Blessed be the name of the Lord;
That He might man redeem!	Blessed be the name,
	Blessed be the name,
	Blessed be the name of the Lord.

CAN YOU GUESS BIBLE TRUTH 3:

How Can We Be Saved?

It Is God's Free Gift...

When the Holy Spirit Works in Our

----- !

**HINT: What did God put deep inside of us
so we can know and love Him?
It starts with an "h" and it rhymes with "starts."**

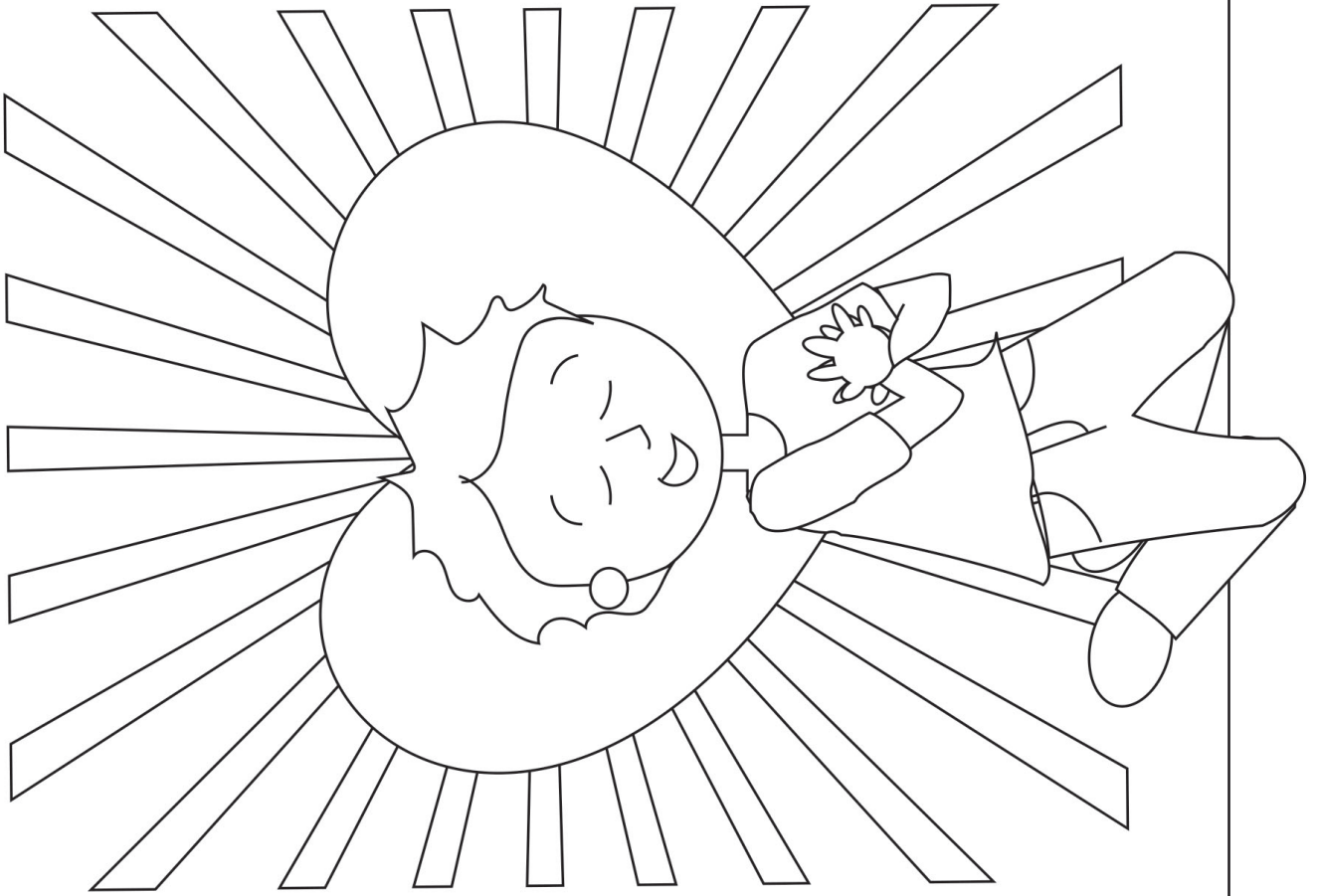

Deep Down Detective Devotion: Unit 11, Bible Truth 3, Lesson 1



Big Question 11: How Can We Be Saved?

Answer: It Is God's Free Gift... When the Holy Spirit Works in Our Hearts!

Bible Truth 3 Meaning

All of us are sinners. We would rather do things our own way rather than obey God. We have hearts that are dead and empty of love for Him and His good ways. We would never choose to love God on our own. But guess what God does for His people? He treats them so much better than they deserve! He sends His Holy Spirit to work in their hearts. When they hear God's Word, He helps them know they are sinners. He helps them want to stop disobeying God and trust in Jesus as their Savior. He makes their hearts alive to God. Now, they know God and want to obey and love Him. We can be God's people, too! We can ask God to send the Holy Spirit to work in our hearts. He can help us to ask God to forgive our sins, trust Jesus as our Savior, and live for Him. Then we can know God in our hearts, now; and when we die, we will go to live perfectly happily with Him forever.

How do I know this is true? The Bible tells me so!

"...He saved us, not because of works done by us in righteousness, but according to his own mercy, by the washing of regeneration and renewal of the Holy Spirit." --Titus 3:5-7, ESV

Some Questions for You

1. Who are sinners? *All of us.*
2. Would we rather do things our way or God's way? *Our way!*
3. What are sinners' hearts empty of? *Love for God and His good ways.*
4. Do sinners choose God on their own? *No, they don't.*
5. Who does God send to work in hearts of His people? *The Holy Spirit.*
6. What does the Holy Spirit do in the hearts of God's people? *Helps them to know they are sinners; helps them want to stop disobeying God; helps them trust Jesus as their Savior.*
7. What book does God use? *His Word, the Bible.*
8. Can we ask the Holy Spirit to work in our hearts? *Yes, we can. He can help us turn away from our sins and trust in Jesus as our Savior.*

Let's Pray!

- A** God, we praise You for being the Changer of the hearts of sinful people, like us.
- C** God, we confess that we are all sinners. We have hard hearts that are slow to believe, love, and obey You. We need Jesus to save us!
- T** Thank You for sending Your Holy Spirit to work in the hearts of people like us, so we can know You, love You, and live for You. You give us what we need but could never get on our own.
- S** God, send the Holy Spirit to work in our hearts. Give us faith as we hear Your Word, the Bible. Help us to turn away from our sins and trust in Jesus as our Savior. Make us new creations! Give us the new birth! We want to know You and live for You! In Jesus' name we pray, Amen.

Let's Sing about What We're Learning!

Big Q & A 11 Song from *Deep Down Detectives ESV Songs 11, track 12*
(adapted version of "Here We Go Looby Loo")

How can we be saved?
How can we be saved?
How can we be saved?
It is God's free gift!

Big Question 11 Action Rhyme Song

 from *Deep Down Detectives ESV Songs 11, track 13*

Refrain:

How can we be saved?
How can we be saved?
How can we be saved?
It's God's free gift.
How can we be saved?
How can we be saved?
How can we be saved?
How can we be saved?
It's God's free gift through Christ.

Verse 1

I disobey God, I need a Savior,
You disobey God, You need a Savior,
We all disobey God, We need a Savior.
To save us from our sins. *Refrain*

Verse 2

Jesus, He paid the price, the perfect sacrifice,
On the cross, gave His life,
Bought us eternal life,
Takes away all our sin,
Makes our hearts clean within,
When we repent and believe in Him. *Refrain*

“He saved us, not because of works done by us in righteousness, but according to his own mercy, by the washing of regeneration and renewal of the Holy Spirit.” --Titus 3:5-7, ESV

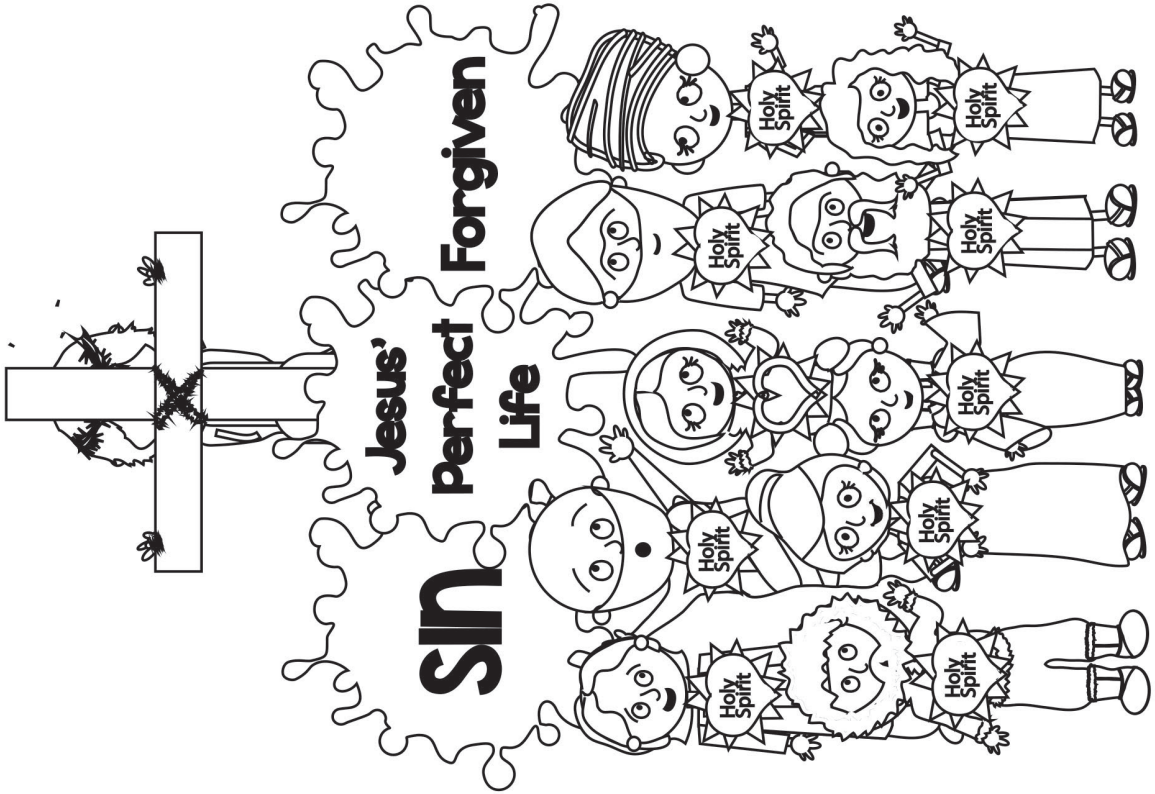

Deep Down Detective Devotion: Unit 11, Bible Truth 3, Lesson 2



Big Question 11: How Can We Be Saved?

Answer: It Is God's Free Gift... When the Holy Spirit Works in Our Hearts!

How do I know this is true? The Bible tells me so!

"...He saved us, not because of works done by us in righteousness, but according to his own mercy, by the washing of regeneration and renewal of the Holy Spirit." --Titus 3:5-7, ESV

Learn a Little: "He saved us by the Holy Spirit."

Meaning

We can never please God with our own, good works. Only through Jesus' perfect life offered up in the place of sinners can we be saved. And what a salvation it is! God, Himself, sends His Holy Spirit to work in the hearts of His people. He gives them the gift of faith. He helps them turn away from their sins. He makes them clean of their sins and all new on the inside. This is how we, too, can become God's people--His heirs; that is, His children who will receive eternal life and live with Him forever.

Some Questions for You

1. Can we ever please God with our own, good works? *No.*
2. Whose perfect life can pay for our sins and save us? *Jesus'!*
3. Who does God send to work in our hearts? *The Holy Spirit.*
4. What does the Holy Spirit do inside of the hearts of people? *He helps them turn away from their sins and trust in Jesus as their Savior. He makes their hearts clean, as if they had never sinned. He lives inside of them and makes them God's people forever.*
5. Can we ask the Holy Spirit to work in our heart? *Yes, we can! God loves to answer this prayer!*

Let's Pray!

- A** God, we praise You for being the Changer of the hearts of sinful people, like us.
- C** God, we confess that we are all sinners. We have hard hearts that are slow to believe, love, and obey You. We need Jesus to save us!
- T** Thank You for sending Your Holy Spirit to work in the hearts of people like us, so we can know You, love You, and live for You. You give us what we need but could never get on our own.
- S** God, send the Holy Spirit to work in our hearts. Give us faith as we hear Your Word, the Bible. Help us to turn away from our sins and trust in Jesus as our Savior. Make us new creations! Give us the new birth! We want to know You and live for You! In Jesus' name we pray, Amen.

Let's Sing Our Bible Verse!

He Saved Us: Titus 3:5-7 from *Deep Down Detectives* ESV Songs 11, track 21

He saved us, he saved us,
By regeneration
And renewal of the Spirit.
He saved us, he saved us,
By the Holy Spirit.

The Holy Spirit whom he poured out,
On us richly,
Through Jesus Christ our Lord,
The Holy Spirit whom he poured out,
On us, through Jesus Christ.
Titus Three, verses five through seven.

Go to the *Deep Down Detectives* Parent Resources for Unit 11 to get the Bible story and many more resources and songs for this unit at praisefactory.org

DDD BQ11 BT 3 L2 Coloring Sheet/Take Home pg2

Which four of these clues belong in our story? Which two do not? Put an X in the boxes of the four that belong.

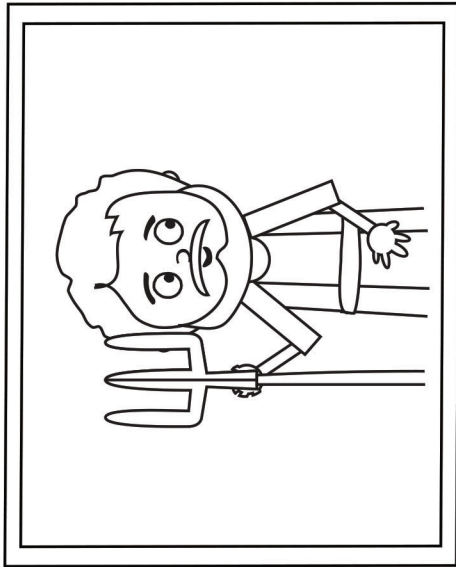

A Farmer

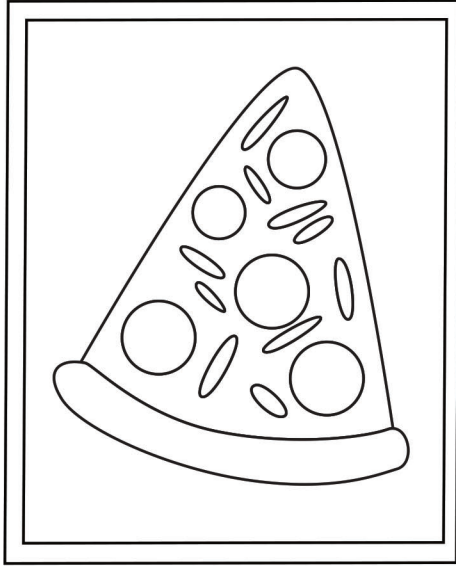

A Pizza

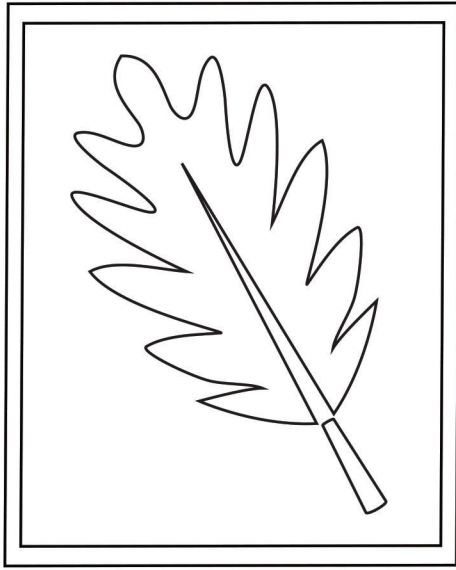

A Leaf

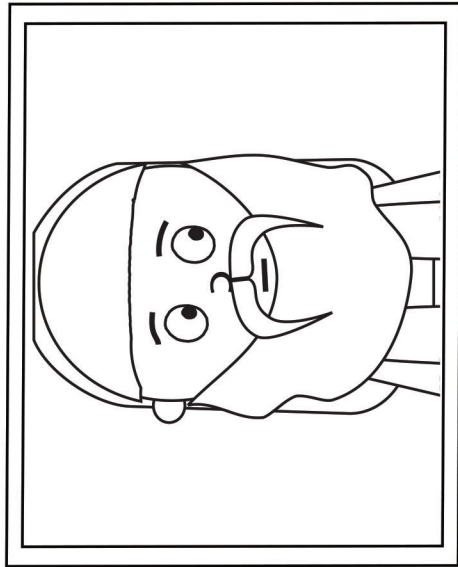

An Important Man

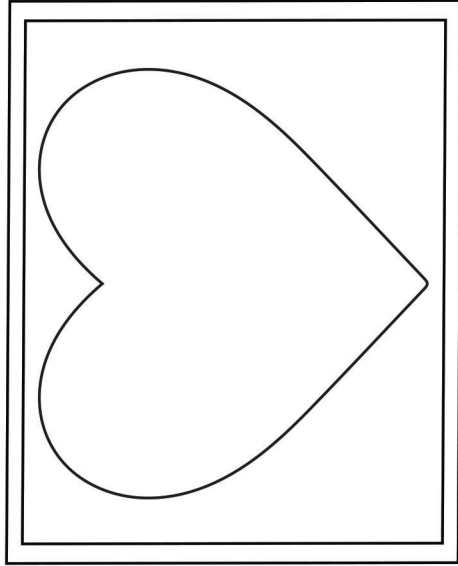

A Heart

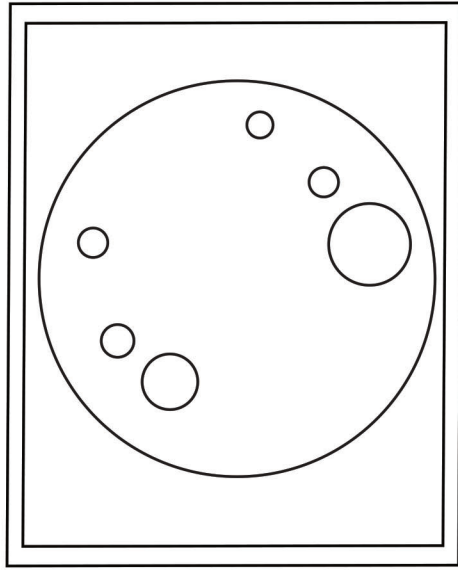

The Moon

Answer: The farmer, important city person, a heart, and the moon belong. The pizza and the leaf do not.

Deep Down Detective Devotion: Unit 11, Bible Truth 3, Lesson 3



Big Question 11: How Can We Be Saved?

Answer: It Is God's Free Gift... When the Holy Spirit Works in Our Hearts!

Bible Truth 3 Meaning

All of us are sinners. We would rather do things our own way rather than obey God. We have hearts that are dead and empty of love for Him and His good ways. We would never choose to love God on our own. But guess what God does for His people? He treats them so much better than they deserve! He sends His Holy Spirit to work in their hearts. When they hear God's Word, He helps them know they are sinners. He helps them want to stop disobeying God and trust in Jesus as their Savior. He makes their hearts alive to God. Now, they know God and want to obey and love Him. We can be God's people, too! We can ask God to send the Holy Spirit to work in our hearts. He can help us to ask God to forgive our sins, trust Jesus as our Savior, and live for Him. Then we can know God in our hearts, now; and when we die, we will go to live perfectly happily with Him forever.

How do I know this is true? The Bible tells me so!

"...He saved us, not because of works done by us in righteousness, but according to his own mercy, by the washing of regeneration and renewal of the Holy Spirit." --Titus 3:5-7, ESV

Some Questions for You

1. What were the country people and the city people think about Jesus? *They were amazed at the things He told them about God and the great things He did by God's power.*
2. Who was working in the hearts of people as Jesus taught them about God? *The Holy Spirit.*
3. What was the Holy Spirit doing in people's hearts? *He was giving them faith to believe in Jesus and to want to turn away from disobeying God and trust in Jesus as their Savior.*
4. Who was Nicodemus? *He was an important teacher of God's Word who lived in the big city of Jerusalem.*
5. What was something new that Jesus taught Nicodemus? *That no one can do enough good things to please God. We are all sinners. We all need God's Holy Spirit to come into our hearts and clean them of sin and give us faith to believe in Jesus.*
6. What is something we can ask God the Holy Spirit to do in our hearts today? *To work in our hearts, helping us to turn away from disobeying God and trust in Jesus as our Savior. Then, our hearts will be clean of sin and we will be born again as God's dearly-loved people. Ask Him to help you. He loves to answer this prayer!*

Let's Pray!

- A** God, we praise You for being the Changer of the hearts of sinful people, like us.
- C** God, we confess that we are all sinners. We have hard hearts that are slow to believe, love, and obey You. We need Jesus to save us!
- T** Thank You for sending Your Holy Spirit to work in the hearts of people like us, so we can know You, love You, and live for You. You give us what we need but could never get on our own.
- S** God, send the Holy Spirit to work in our hearts. Give us faith as we hear Your Word, the Bible. Help us to turn away from our sins and trust in Jesus as our Savior. Make us new creations! Give us the new birth! We want to know You and live for You! In Jesus' name we pray, Amen.

Let's Praise God Right Now!

Big Question 11 Hymn: Grace that Is Greater than All Our Sin from *Deep Down Detectives* ESV Songs 11, track 15

Verse 1

Grace, grace, God's grace,
Grace that will pardon and cleanse within;
Grace, grace, God's grace,
Grace that is greater than all our sin.

Words: Julie H. Johnston Music: Daniel B. Towner

Go to the *Deep Down Detectives* Parent Resources for Unit 11 to get the Bible story and many more resources and songs for this unit at praisefactory.org

Big Question 11 Praise Song: Blessed Be the Name from *Deep Down Detectives* ESV Songs 11, track 16

All praise to Him who reigns above	Blessed be the name,
In majesty supreme.	Blessed be the name,
Who gave His Son for man to die,	Blessed be the name of the Lord;
That He might man redeem!	Blessed be the name,
	Blessed be the name,
	Blessed be the name of the Lord.