

CAN YOU GUESS BIBLE TRUTH!
How Should God's People Live?
They Should Live Like Jesus...

By Asking God for His

----- !

HINT: What do we need when we can't do something by ourselves? It starts with an "h" and it rhymes with "yelp."

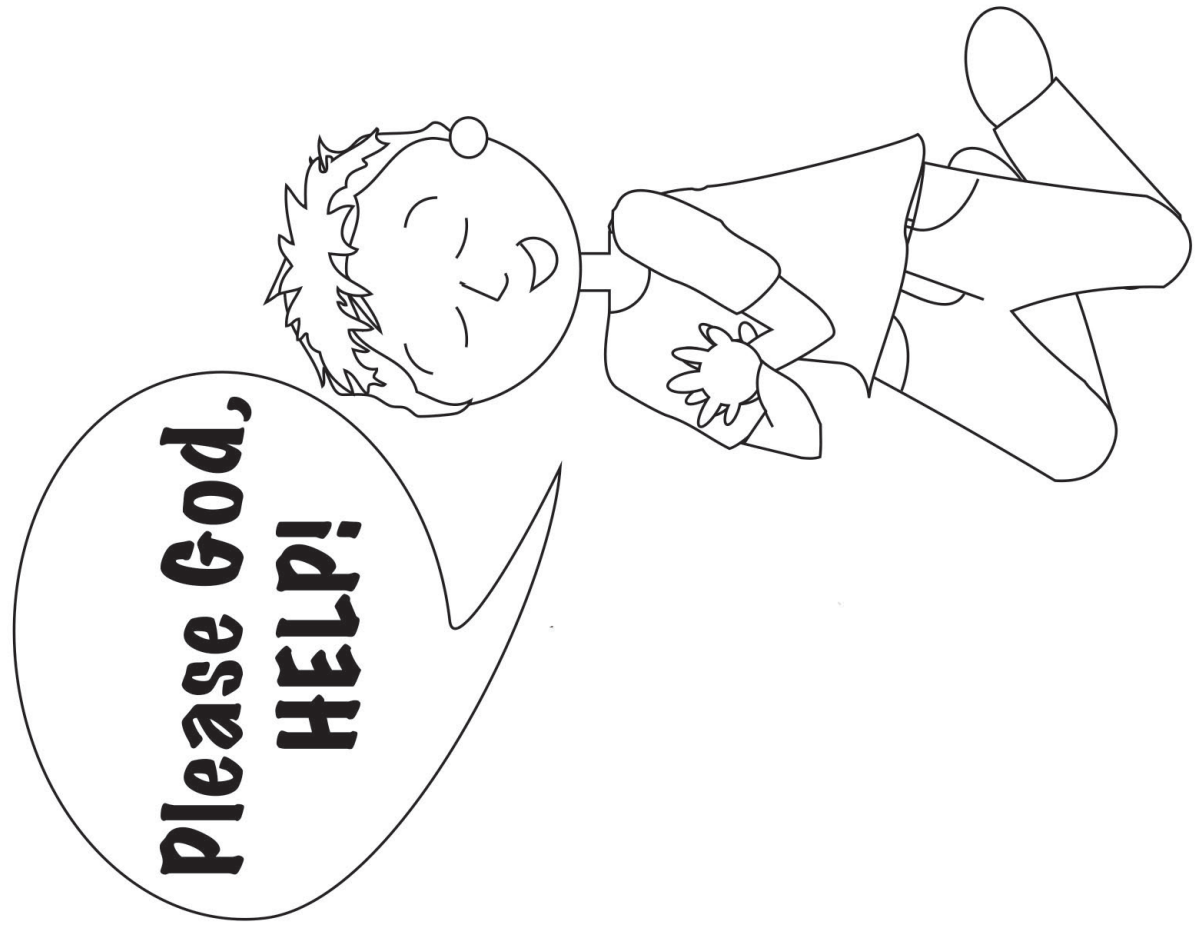

Deep Down Detective Devotion: Unit 12, Bible Truth 1, Lesson 1



Big Question 12: How Should God's People Live?

Answer: They Should Live Like Jesus... By Asking God for His Help!

Bible Truth 1 Meaning

When Jesus lived on earth, He asked God, His Father, for help to do everything He wanted Him to do. God wants His people to ask Him to help them, too. The Bible is filled with God's promises to help His people. God's people can pray these promises for themselves. They can pray them for others, too. One of God's best promises is to send the Holy Spirit to keep working in His people's hearts. The Holy Spirit helps them to know what God wants them to do. He makes them strong and brave to do it. God is faithful. He will always help His people to live like Jesus, every single day. We can become God's people when we turn away from our sins and trust in Jesus as our Savior. Ask God to help you. He loves to answer this prayer!

How do I know this is true? The Bible tells me so!

"Let us then approach the throne of grace with confidence, so that we may receive mercy and find grace to help us in our time of need." -- Hebrews 4:16

Some Questions for You

1. Who did Jesus ask for help when He lived on earth? *God, His Father.*
2. What kinds of things did Jesus ask His Father's help in? *Everything He wanted Him to do.*
3. Who should God's people ask to help them? *God.*
4. The Bible is filled with promises of what? *God's promise to help them.*
5. Who can God's people pray these promises for? *Themselves and others.*
6. Who can God's people ask for God to send to help them? *The Holy Spirit.*
7. What does the Holy Spirit do? *He helps God's people know what God wants them to do. He makes them strong and brave to do it.*
8. How can we become God's people? *When we turn away from our sins and trust in Jesus as our Savior.*

Let's Pray!

- A** God, we praise You for giving us Jesus, so we can know how You want us to live.
- C** God, we need Your help to live for You, but many times we don't ask for it. We love to do things by ourselves, in our own way. We need a Savior!
- T** Thank You, God, for promising to help Your people live like Jesus. They could never do this without Your help.
- S** God, please work in our hearts. Help us turn away from our sins and trust in Jesus as our Savior. Make us Your people. Help us to love You. Help us to live like You want us to. In Jesus' name we pray, Amen.

Let's Sing about What We're Learning!

Big Q & A 12 Song from *Deep Down Detectives NIV Songs 12, track 12*
(sung to the tune of "Twinkle, Twinkle, Little Star")

How should God's people live each day? They should live like Jesus!
How should God's people live each day? How should God's people live each day?
How should God's people live each day? They should live like Jesus!

Big Question 12 Action Rhyme Song from *Deep Down Detectives NIV Songs 12, track 13*

Refrain:

How should God's people live?
How should God's people live?
How should God's people live? *Point up to God in heaven*
They should live like Jesus!

Verse 1

Jesus loved God most of all, *Touch heart, then point up to God in heaven*
He loved all people, too,
In all that He did
and said and thought, *Point out to others*
He loved them thru and thru. *Refrain Touch heart*

Verse 2

God's people should love God *Point up to God in heaven*
most of all,
They should love others, too, *Point out to others*
And God the Holy Spirit,
Will help them in all they do. *Touch heart*
Refrain

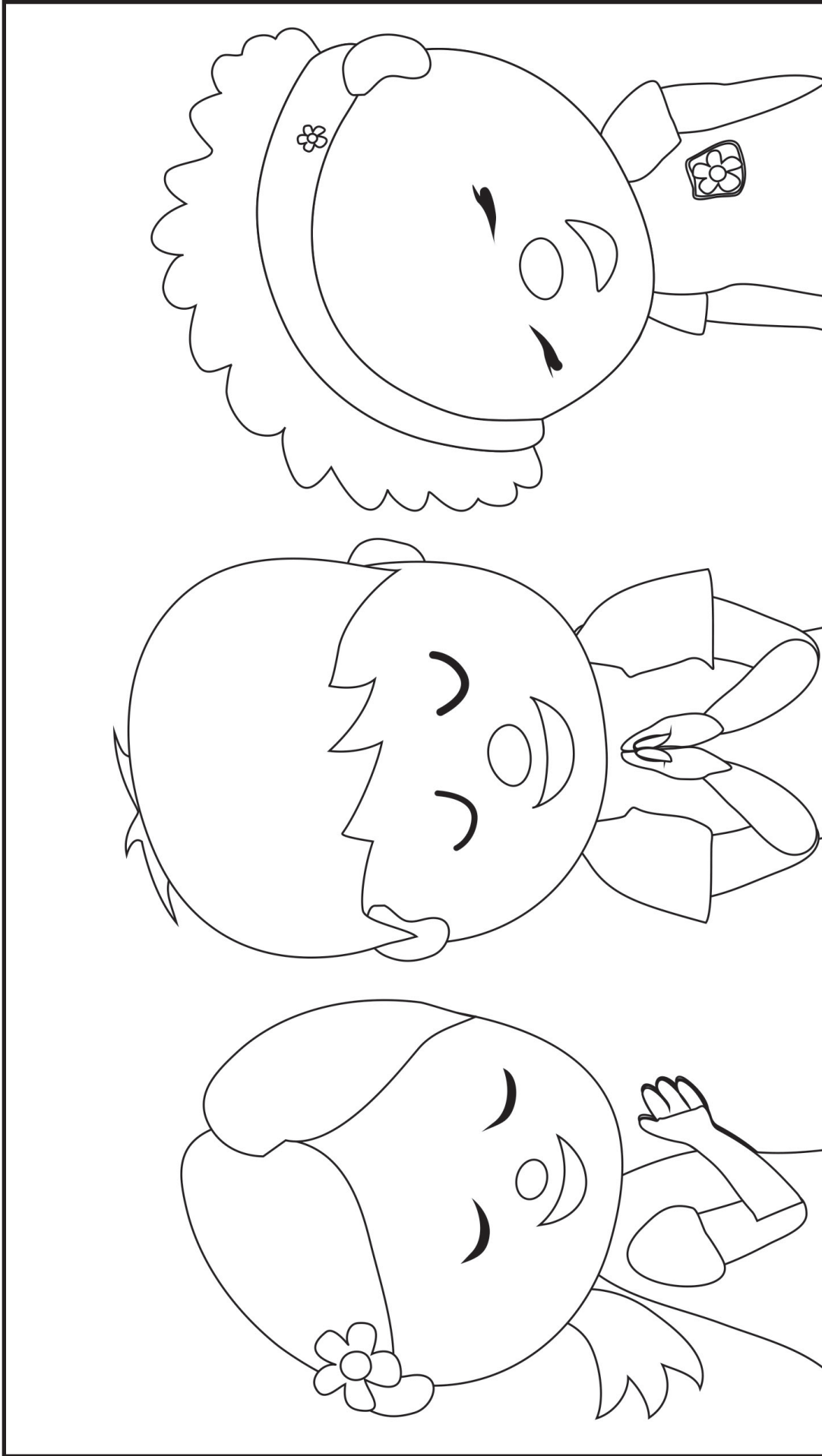

**Let us then approach the throne of grace with confidence,
so that we may receive mercy and find grace to help us
in our time of need.” Hebrews 4:16**

Deep Down Detective Devotion: Unit 12, Bible Truth 1, Lesson 2



Big Question 12: How Should God's People Live?

Answer: They Should Live Like Jesus... By Asking God for His Help!

How do I know this is true? The Bible tells me so!

"Let us then approach the throne of grace with confidence, so that we may receive mercy and find grace to help us in our time of need." -- Hebrews 4:16

Learn a Little: "Let us approach so that we may find help in our time of need."

Meaning

Jesus reigns in heaven as the High King over all creation. How He loves God's people! He listens to their prayers and even prays for them, Himself! He promises to give them everything they need to live for God and to do all He wants them to do. God's people know they can always pray and ask God to help them. They know His answer is always "yes" when they ask Him to help them. He will give them the strength they need to do all He wants them to do. That's why they go boldly and confidently to God with their prayers. He will help them. He will always help them! We can become God's people, too, when we turn away from our sins and trust in Jesus as our Savior.

Some Questions for You

1. Who reigns in heaven as the High King over all creation? *Jesus does.*
2. What does Jesus promise to do for God's people, even as He is in heaven reigning? *To give them everything they need to live for God. To pray for them.*
3. Who do God's people know they can always pray to and ask for help? *Jesus!*
4. What do God's people know Jesus will always give them the strength to do? *To keep on living for God.*
5. How can we become God's people? *By turning away from our sins and trusting in Jesus as our Savior.*

Let's Pray!

- A** God, we praise You for giving us Jesus, so we can know how You want us to live.
- C** God, we need Your help to live for You, but many times we don't ask for it. We love to do things by ourselves, in our own way. We need a Savior!
- T** Thank You, God, for promising to help Your people live like Jesus. They could never do this without Your help.
- S** God, please work in our hearts. Help us turn away from our sins and trust in Jesus as our Savior. Make us Your people. Help us to love You. Help us to live like You want us to. In Jesus' name we pray, Amen.

Let's Sing Our Bible Verse!

Let Us Then Approach: Hebrews 4:16 from *Deep Down Detectives NIV Songs 12, track 17*

Then us then approach,
Approach the throne of grace,
With confidence, with confidence,
So we may receive mercy and find grace,
To help us in our time of need.
Then us then approach,
Then us then approach,
Then us then approach,
The throne of grace,
Hebrews Chapter Four, sixteen.

Go to the *Deep Down Detectives Parent Resources for Unit 12* to get the Bible story and many more resources and songs for this unit at praisefactory.org

Which four of these clues belong in our story? Which two do not? Put an X in the boxes of the four that belong.

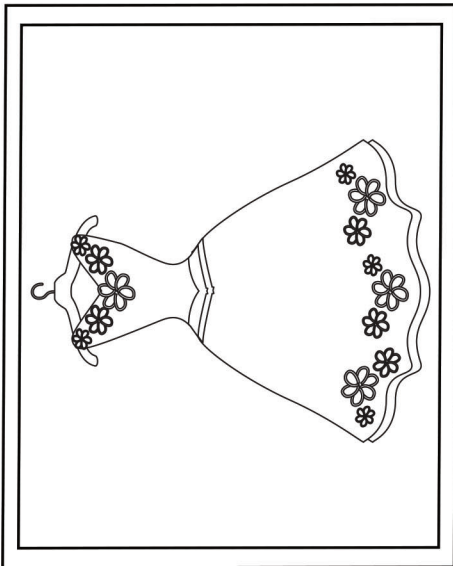

A Dress

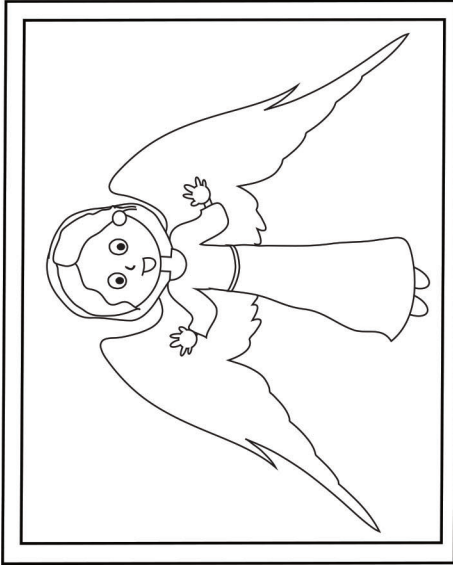

An Angel

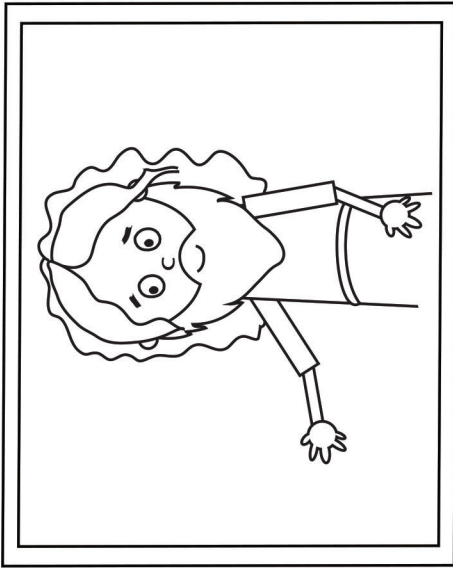

Jesus

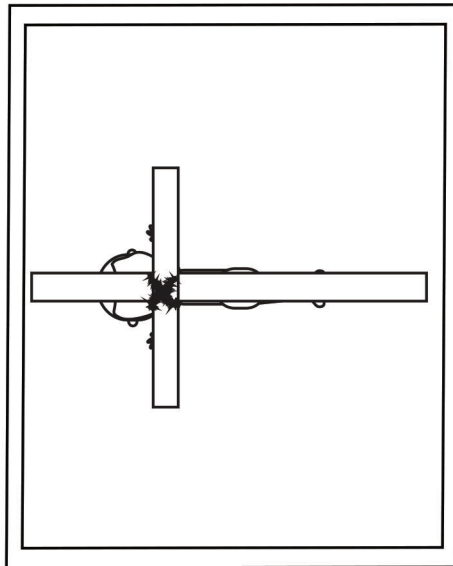

A Cross

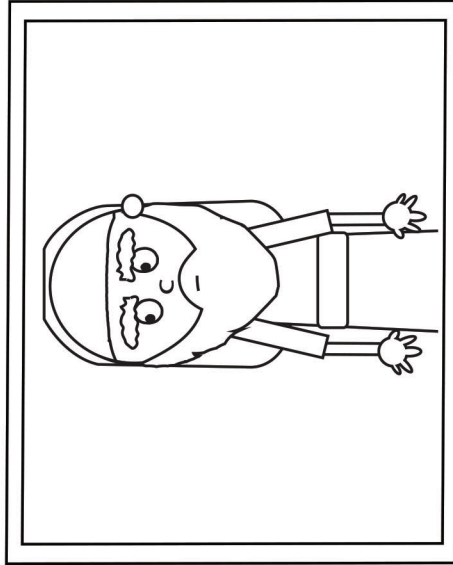

An Enemy

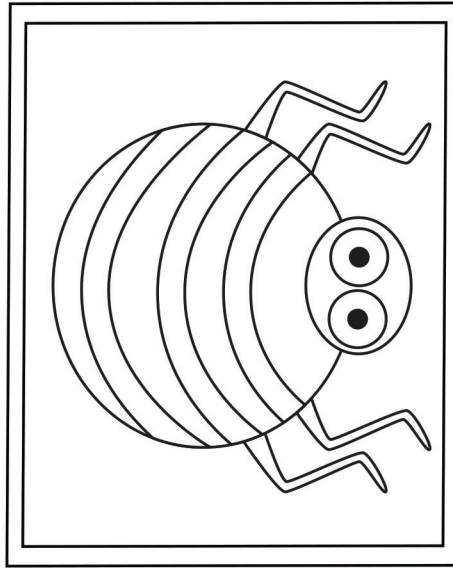

A Spider

Answer: The angel, the cross, Jesus and the enemy belong. The dress and the spider do not.

Deep Down Detective Devotion: Unit 12, Bible Truth 1, Lesson 3



Big Question 12: How Should God's People Live?

Answer: They Should Live Like Jesus... By Asking God for His Help!

Bible Truth 1 Meaning

When Jesus lived on earth, He asked God, His Father, for help to do everything He wanted Him to do. God wants His people to ask Him to help them, too. The Bible is filled with God's promises to help His people. God's people can pray these promises for themselves. They can pray them for others, too. One of God's best promises is to send the Holy Spirit to keep working in His people's hearts. The Holy Spirit helps them to know what God wants them to do. He makes them strong and brave to do it. God is faithful. He will always help His people to live like Jesus, every single day. We can become God's people when we turn away from our sins and trust in Jesus as our Savior. Ask God to help you. He loves to answer this prayer!

How do I know this is true? The Bible tells me so!

"Let us then approach the throne of grace with confidence, so that we may receive mercy and find grace to help us in our time of need." -- Hebrews 4:16

Some Questions for You

1. What did Jesus ask God His Father to help Him to do? *To suffer and die on the cross.*
2. Who else did Jesus tell to ask God for help? *His followers, God's people.*
3. Did His followers ask for help? *No, they slept!*
4. How do we know that God answered Jesus' prayers? *Because Jesus did not run away but let Himself be arrested and suffer and die on the cross.*
5. How do we know that Jesus paid for all the sins of God's people? *Because God raised Him from the dead on Day Three.*
6. What did Jesus' followers learn to do? *To ask God for help with everything they went through.*
7. What can we ask God to help us to do? *To turn away from our sins and trust in Jesus as our Savior. To help us to know and love Him more and more. This is how we become God's people.*

Let's Pray!

- A** God, we praise You for giving us Jesus, so we can know how You want us to live.
- C** God, we need Your help to live for You, but many times we don't ask for it. We love to do things by ourselves, in our own way. We need a Savior!
- T** Thank You, God, for promising to help Your people live like Jesus. They could never do this without Your help.
- S** God, please work in our hearts. Help us turn away from our sins and trust in Jesus as our Savior. Make us Your people. Help us to love You. Help us to live like You want us to. In Jesus' name we pray, Amen.

Let's Praise God Right Now!

Big Q & A 12 Hymn: Trust and Obey, v.1

from *Deep Down Detectives NIV Songs 12, track 15*

Verse 1

When we walk with the Lord,
In the light of His Word,
What a glory He sheds on our way!
While we do His good will;
He abides with us still,
And with all who will trust and obey.

Refrain

Trust and obey,
For there's no other way,
To be happy in Jesus,
But to trust and obey.

Words: John H. Sammis Music: Daniel B. Towner

Big Question 12 Praise Song: I Have Decided to Follow Jesus

from *Deep Down Detectives NIV Songs 12, track 16*

I have decided to follow Jesus,
I have decided to follow Jesus,
I have decided to follow Jesus,
No turning back, no turning back.

Go to the *Deep Down Detectives Parent Resources for Unit 12* to get the Bible story and many more resources and songs for this unit at praisefactory.org

DDD BQ 12 BT 1 L3 Coloring Sheet/Take Home pg2

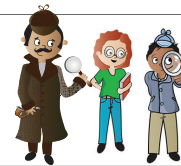
**The Case of the Day of Hardest Thing**

Matthew 26-28; Mark 14-16; Luke 22-24; John 18-21

Dear Parents,

Big Question #12 is: "How Should God's People Live?" Your child is learning that "They Should Live Like Jesus...By Asking God for His Help."

Here's a copy of the Bible story they are learning along with the "Listening Assignment" for each lesson. These assignments provide a different teaching emphasis for each lesson, helping the children dig deeper into each Bible truth. They match up with your child's take home for each lesson. We hope that these resources help your family to dig down deeper into the truths of God's Word!" Happy digging!

•many more resources for this Big Question can be found online at www.praisefactory.org•

Listening Assignments

"Hey, Kids! Detective Dan, here. Listen carefully to the story and help me answer these questions:

Detective Dan's Lesson #1 Listening Assignment:

I need to find out:

- 1. Who did the hardest thing? What was it?**
- 2. Who helped Him do it?**

Detective Dan's Lesson #2 Listening Assignment:

Our Bible Verse is Hebrews 4:16

"Let us then approach the throne of grace with confidence, so that we may receive mercy and find grace to help us in our time of need."

I need to find out:

- 1. What was the very hard thing Jesus was called to do? Who did Jesus cry out to for help?**
- 2. Did Jesus get the help He needed?**

Detective Dan's Lesson #3 Listening Assignment:

I found six clues, but only 4 of them are in the story.

Our six clues were: a dress, an angel, the cross, Jesus, an enemy, and a spider.

Hold each of them up for the children to see as you identify them.

I need to figure out:

- 1. Which four belong in the story and which two don't?**
- 2. What did Jesus ask God to do for him? How did God answer His prayer?**

Read the assignment questions, THEN SAY,

"Ok, Deep Down Detectives! Put on your best listening ears and see if you can hear the answers to Detective Dan's questions. When I finish telling the story, we will see if we can answer all the questions."

Read the Bible Truth story, answer questions, present the gospel and lead in prayer.

Answers to questions; the gospel; and, ACTS prayer are included with the story text.

The Case of the Hardest Thing *Matthew 26-28; Mark 14-16; Luke 22-24; John 18-21**Story with lines separating paragraphs (text in bold, optional interaction cues in italics)*

It was late at night and Jesus knew He needed help. And not just help from anyone. No! There was only ONE who could help Him. Do you know who it was?

Who do you think it was?

It was God, His Father.

Very soon, Judas Iscariot, one of Jesus' disciples and closest friends, would bring enemies to arrest Him. These enemies would hurt Jesus. They would say mean things to Him. And then, they would nail Him to a cross to die.

Dying on a cross was a very painful way to die. But Jesus would do something as He died on the cross that would make it the most painful thing ANYONE has ever done. Jesus would take all the punishment God's people deserved from God for their sins. He would pay for their sins, so they wouldn't have to. Oh, how, very, very, VERY terrible all that punishment would be!

In some ways, Jesus wasn't that different from us. He thought about all the pain He would bear on the cross, and He didn't want it. Yet, how Jesus loved God, His Father! He always wanted to obey Him. And, how Jesus loved God's people! He wanted to save them. Dying on the cross was the only way to obey His Father and save God's people. And that's why Jesus knew He needed help —God, His Father's help— to do this very hardest thing.

And that's why, Jesus knew He needed help —God, His Father's help— to do all He was about to do.

Jesus walked with His disciples down the streets of Jerusalem, out through the city wall, and up the hill to the Garden of Gethsemane. Jesus knew He needed help from His Father, and it was there that He was going to ask for it. Do you know how?

What do you think Jesus did?

Jesus would pray! "Sit here, while I go over there and pray," He told His disciples.

Taking Peter, James, and John with Him, Jesus walked further into the dark garden. As Jesus walked, He became very sad and upset. "The sadness in My heart is so great that it's almost killing me!" Jesus told His friends. "Stay here with Me and keep watch," He asked them.

Going a little farther, Jesus fell face down on the ground and prayed. "My Father, if it's possible, take this away so I don't have to suffer like this," Jesus pleaded. "This is going to be so hard! This is going to hurt so much! But most of all, I want Your will, not Mine, Father," Jesus exclaimed.

After praying, Jesus went to check up on Peter, James, and John. He was NOT happy with what He found them doing. While HE had been face down on the ground, praying, THEY had been face down on the ground doing something else. Can you guess what it was?

They were sound asleep!

Story with lines separating paragraphs (text in bold, optional interaction cues in italics)

“Peter, wake up! Couldn’t you watch with Me this one hour?” Jesus exclaimed. “Watch and pray that you might say ‘no’ to temptation. You WANT to stay faithful to Me. You WANT to do God’s will, but you are very weak. You will need God’s help to do these things,” Jesus warned them.

Jesus knew that He wasn’t the only one who would need God’s help to do God’s will. His disciples would need God’s help, too. When the enemies came for Jesus, they would be tempted to be afraid and leave Jesus. But God could give them the strength they needed if they would ask.

Jesus went and prayed again. **“My Father, if suffering and dying on the cross is the only way to save Your people, then I want to do it. I want to obey You and do Your will more than anything else,”** Jesus exclaimed.

What a prayer! What a very, very hard thing Jesus would have to do to save God’s people! It was the hardest thing anyone would EVER have to do. COULD God, His Father, answer this prayer? WOULD God, His Father, answer this prayer?

What do you think?

Yes, He could; and, yes, He WOULD! God answered Jesus’ prayer. An angel came to strengthen Jesus.

Jesus was strengthened in His heart, too. Yes, He would have to suffer and die for God’s people. But, then, what joy He would have! On Day Three, He would rise from the dead in victory over sin and death. Then, He would return home to heaven. There, He would once more enjoy the Perfect Wonderfulness of the fullest, closest fellowship with God, the Father, and God, the Holy Spirit, like He had before He came to earth.

Jesus would be the great King who always loved and obeyed God, His Father. How great would be the praise for God! How good to never suffer again! And, how wonderful to know that the sins of God’s people would be forgiven for all time.

Strengthened and comforted, Jesus went back to His friends two more times. Were they praying? Were they asking God for His help?

What do you think?

No! Each time, He found them sleeping. Oh, if only they understood just how much they were about to need God’s help! “Are you still sleeping? But look, the time has come. Get up! Here come My enemies,” Jesus told them.

Just then, there came a whole crowd of enemies carrying lanterns, fiery torches, and sharp swords. And who was leading them?

Can you guess who?

Why Judas Iscariot, Jesus’ other disciple, that’s who! He had been paid by Jesus’ enemies to take them to Jesus to arrest Him.

The time had come for Jesus to suffer and die. What would He do? Run away and hide?

What do you think He will do?

Story with lines separating paragraphs (text in bold, optional interaction cues in italics)

No, He would not. Jesus was ready. He had asked His Father for help; and, His Father had answered Him. He gave Jesus the strength to keep on doing His will. Jesus would face His enemies and fulfill God's plan.

In the darkness, it was hard to tell which man was Jesus. But Judas led Jesus' enemies right to Him. "Hello, Teacher," Judas said, kissing Jesus on the cheek. "Friend, do what you came to do," Jesus replied. Then, the men came up and grabbed Jesus.

"Oh, no you don't!" thought Peter. He would fight off Jesus' enemies. He took his sword and cut off Malchus' ear --one of the men in the crowd.

But this wasn't the help Jesus wanted or needed. Jesus stretched out His hand and healed Malchus' ear. "Put away your sword," Jesus told Peter. "I could ask My Father to send thousands of angels to rescue Me, if I wanted. But how would His will be done if I did that? And how would God's promises in His Word come true? No. it must happen this way," Jesus replied. Oh, how God was helping His Son, Jesus, do this hardest thing!

But what about Jesus' disciples? What did they do? They had slept, instead of asking God for help. Did they stand with Jesus or run away?

What do you think they did?

It was just as Jesus warned. His disciples didn't have the strength to stay faithful. They gave in to their fears. They ran for their lives, leaving Jesus alone with His enemies.

After that, everything happened as Jesus knew it would. The crowd took Jesus away. They said mean things to Him and they hurt Him. They nailed Him to the cross; and there, Jesus suffered and died for the sins of God's people.

Oh, how terrible it was to suffer and die for God's people, but Jesus did it anyway! He had asked God, His Father, for help; and God, His Father, gave it to Him. He helped Jesus take all the punishment for the sins of God's people, so they wouldn't have to. He helped Jesus do the hardest thing!

And how do we know Jesus paid for all those sins when He suffered and died on the cross? Because of what Jesus did on the third day. Do you know what He did?

Can you tell me?

Jesus rose up from the grave to live forevermore! Jesus had really beaten sin and death for God's people. Their sins were all forgiven. They would get to live with God, knowing, loving, and enjoying Him forever.

But what about Jesus' disciples? What happened to them after they ran away and left Jesus? Would God forgive them now? COULD God forgive them now?

What do you think? Could God really forgive these men for leaving Jesus' all alone like this?

Yes, He could; and yes, He WOULD! Jesus paid for ALL their sins when He died on the cross.

Story with lines separating paragraphs (text in bold, optional interaction cues in italics)

And, though the disciples hadn't asked God for help, the night Jesus was arrested, Jesus had prayed for them.

That night, Jesus had prayed for them and all of God's people. Jesus had asked His Father to protect them from Satan and his evil plans. He had asked Him to help them to grow in love for God and for one another so the world might know He really is God's Son, the Savior.

Wow! What big prayers Jesus prayed for His disciples and all of God's people that night! Would God answer them? COULD God answer them?

What do you think?

Yes, He could; and, yes, He WOULD! Jesus appeared to His disciples on that third day after He died on the cross. "I'm alive and I've beaten sin and death for you and all of God's people!" He told them. 22. Over the next 40 days, Jesus taught His disciples from the Bible. He told them about God's great plan to use them to tell the whole world the gospel--the good news of salvation. And, He promised them God's great gift, the Holy Spirit, who would come live inside them and help them. At the end of those 40 days, Jesus went to heaven. He was home, once more, at last, enjoying all the Perfect Wonderfulness He had always known with God, the Father, and God, the Holy Spirit, from before the beginning of time.

Jesus had left earth for His home in heaven, but He never forgot His people. Jesus is always praying for them, helping them fulfill all of God's good plans. He asked the Father to send the Holy Spirit to live in their hearts, and so He did. He would help them love God, live for Him, and tell the world the good news of Jesus their whole lives.

And, oh, how those first believers had learned their lesson to ask God for His help! There were many more times when they were tempted to not be faithful to Jesus. And many more times when they would want to run away because their enemies wanted to hurt them. But now, they knew what to do. They prayed to God and asked for His help! And did He give it to them?

What do you think?

Yes, He did! Those first believers had learned their lesson to ask God for His help!

And that's why God STILL wants His people to ask Him for help to live for Him. He knows that His people today need just as much help as they did long ago. We can become God's people, too, if we turn away from our sins and trust in Jesus as our Savior. Then, God will help us live for Him, too! Ask Him to help you. He loves to answer this prayer.

Cracking the Case: (story wrap-up for Listening Assignments)

It's time to see how we did with our Listening Assignment.

Detective Dan's Lesson 1 Listening Assignment:

1. Who did the hardest thing? What was it? Jesus did. Jesus lived a perfect life and offered it up on the cross as the full payment for the sins of God's people. He suffered and died for them. On the third day, Jesus rose from the dead in victory.

2. Who helped Him do it? God, His Father, helped Jesus do it.

For You and Me:

Did you know that God calls all His people to do hard things they can never do on their own? And who will help them do these hard things? The very same One who helped Jesus--God! God will always help His people do whatever He calls them to do. We can become God's people, too, when we turn away from our sins and trust in Jesus as our Savior. If we do, we can know God will help us to do whatever He calls us to do, too.

Detective Dan's Lesson 2 Listening Assignment:**Our Bible Verse is Hebrews 4:16:**

"Let us then approach the throne of grace with confidence, so that we may receive mercy and find grace to help us in our time of need."

1. What was the very hard thing Jesus was called to do? Who did Jesus cry out to for help?

To live a perfect life and offer it up on the cross as the full payment for the sins of God's people. To suffer and die for them. He asked God, His Father, to help Him do it all.

2. Did Jesus get the help He needed? Yes, He did! God helped Him do it all... perfectly!

For You and Me:

Did you know that God calls all His people to do hard things they can never do on their own? And who will help them do these hard things? The very same One who helped Jesus--God! God will always help His people do whatever He calls them to do. We can become God's people, too, when we turn away from our sins and trust in Jesus as our Savior. If we do, we can know God will help us to do whatever He calls us to do, too.

Detective Dan's Lesson 3 Listening Assignment:

Our six clues were: a dress, an angel, the cross, Jesus, an enemy, and a spider.

1. Which four belong in our story?

The angel, the cross, Jesus and the enemy.

2. What did Jesus ask God to do for him? How did God answer His prayer?

Jesus asked God, His Father, to help Him carry out the plan to save God's people. God, His Father, answered Him with a "yes"! He helped Him bear the pain of the cross. He helped Him do everything that was needed to save God's people.

For You and Me:

Did you know that God calls all His people to do hard things they can never do on their own? And who will help them do these hard things? The very same One who helped Jesus--God! God will always help His people do whatever He calls them to do. We can become God's people, too, when we turn away from our sins and trust in Jesus as our Savior. If we do, we can know God will help us to do whatever He calls us to do, too.

The Gospel (story wrap-up if NOT using Listening Assignments)**Our Bible Truth is:****How Should God's People Live?****They Should Live Like Jesus...****By Asking God for His Help!**

How should God's people live each day? They should live like Jesus... by asking God for His help! God's people ask God for His help, knowing that He will help them. After all, He has already helped them in the biggest way: by sending Jesus to save them! Even while they still were choosing to disobey Him, God chose to help them by sending Jesus to save them. How much more, now that they turned away from their sins and trusted in Jesus as their Savior, will God help them to live for Him! God delights to help you and me, too. If we turn away from disobeying Him and trust Jesus as our Savior, He will gladly save us! And as His people, He will gladly keep helping us to live for Him!

Close in prayer.

Closing ACTS Prayer

- A** God, we praise You for giving us Jesus, so we can know how You want us to live.
- C** God, we need Your help to live for You, but many times we don't ask for it. We love to do things by ourselves, in our own way. We need a Savior!
- T** Thank You, God, for promising to help Your people live like Jesus. They could never do this without Your help.
- S** God, please work in our hearts. Help us turn away from our sins and trust in Jesus as our Savior. Make us Your people. Help us to love You. Help us to live like You want us to.

In Jesus' name we pray, Amen.

Big Question 12, Bible Truth 1 Overview: Key Concepts

p.1

Unit 12: God's People Live for Him

Unit Big Question (and Answer): How Should God's People Live? They Should Live Like Jesus!

Unit Bible Verse: "Be imitators of God, therefore, as dearly loved children and live a life of love, just as Christ loved us and gave himself up for us." --Ephesians 5:1-2

Bible Truth 1 Concept: They Should Live Like Jesus...By Asking God for His Help

When Jesus lived on earth, He asked God, His Father, for help to do everything He wanted Him to do. God wants His people to ask Him to help them, too.

The Bible is filled with God's promises to help His people. God's people can pray these promises for themselves. They can pray them for others, too. One of God's best promises is to send the Holy Spirit to keep working in His people's hearts. The Holy Spirit helps them to know what God wants them to do. He makes them strong and brave to do it. God is faithful. He will always help His people to live like Jesus, every single day.

We can become God's people when we turn away from our sins and trust in Jesus as our Savior. Ask God to help you. He loves to answer this prayer!

Bible Truth 1 Bible Verse: Hebrews 4:16

"Let us then approach the throne of grace with confidence, so that we may receive mercy and find grace to help us in our time of need."

Learn a Little: "Let us approach so that we may find help in our time of need."

Meaning

Jesus reigns in heaven as the High King over all creation. How He loves God's people! He listens to their prayers and even prays for them, Himself! He promises to give them everything they need to live for God and to do all He wants them to do.

God's people know they can always pray and ask God to help them. They know His answer is always "yes" when they ask Him to help them. He will give them the strength they need to do all He wants them to do. That's why they go boldly and confidently to God with their prayers. He will help them. He will always help them! We can become God's people, too, when we turn away from our sins and trust in Jesus as our Savior.

Bible Truth 1 ACTS Prayer

- A** God, we praise You for giving us Jesus, so we can know how You want us to live.
- C** God, we need Your help to live for You, but many times we don't ask for it. We love to do things by ourselves, in our own way. We need a Savior!
- T** Thank You, God, for promising to help Your people live like Jesus. They could never do this without Your help.
- S** God, please work in our hearts. Help us turn away from our sins and trust in Jesus as our Savior. Make us Your people. Help us to love You. Help us to live like You want us to. In Jesus' name we pray, Amen.

Bible Truth 1 Story**The Case of the Hardest Thing**

Matthew 26-28; Mark 14-16; Luke 22-24; John 18-21

Big Question 12, Bible Truth 1 Overview: Key Concepts

p.2

Songs Used in Bible Truth 1

Big Q & A 12 Song

Big Question 12 Song: How Should God's People Live?

Big Question 12 Bible Verse Song: Live a Life of Love Ephesians 5:2, NIV 1984

Big Question 12 Hymn: Trust and Obey, v.1

Big Question 12 Praise Song: I Have Decided to Follow Jesus

Bible Truth 1 Bible Verse Song: Let Us Then Approach Hebrews 4:16, NIV 1984

Bible Truth 1 Extra Bible Verse: Help Us, O God Our Savior Psalm 79:9, NIV 1984

Bible Truth 1 Extra Bible Verse: We Who Reflect the Lord's Glory 2 Corinthians 3:18, NIV 1984

listen to or download songs for free at <https://praisefactory.org>: Deep Down Detectives Music page