

DEEP DOWN DETECTIVES



**Unit 7 Visual Aids
with
Simple Story Scenes, ESV**



Curriculum for preschool and elementary age children,
training tools, music and other resources
are available for download or to order at:
www.praisefactory.org

© 2022 Praise Factory Media all rights reserved. May be reproduced by licensed user for classroom purposes only.

This and many other resources are available online at www.praisefactory.org

Scripture quotations marked (NIV) are taken from the Holy Bible, New International Version®, NIV®, Copyright © 1973, 1978, 1984 by Biblica, Inc.™ Used by permission of Zondervan. All rights reserved worldwide.www.zondervan.com

Scripture quotations marked (ESV) are from The Holy Bible, English Standard Version® (ESV®), copyright © 2001 by Crossway, a publishing ministry of Good News Publishers. Used by permission. All rights reserved.

Scripture quotations marked HCSB are taken from the Holman Christian Standard Bible®, Copyright © 1999, 2000, 2002, 2003, 2009 by Holman Bible Publishers. Used by permission. Holman Christian Standard Bible®, Holman CSB®, and HCSB® are federally registered trademarks of Holman Bible Publishers.

Table of Contents

About the Deep Down Detectives Visual Aids	5
Unit 7: The Law-Giving God	
What Are God’s Laws Like? God’s Laws Are Perfect!	
Bible Truth 1: They Are Written in the Bible, God’s Word	7
Bible Truth 1 Overview	9
Story	11
Big Question and Answer Sign	17
Unit 7 All Bible Truths Sign	19
Bible Truth 1 Concept Sign	21
Bible Verse Sign	23
Detective Dan’s Listening Assignment #1	25
Detective Dan’s Listening Assignment #2	27
Detective Dan’s Listening Assignment #3	29
Story Scenes	37
Bible Truth 2: They Show Us that We Need God to Save Us	79
Bible Truth 2 Overview	81
Story	83
Big Question and Answer Sign	89
Unit 7 All Bible Truths Sign	91
Bible Truth 2 Concept Sign	93
Bible Verse Sign	95
Detective Dan’s Listening Assignment #1	97
Detective Dan’s Listening Assignment #2	99
Detective Dan’s Listening Assignment #3	101
Story Scenes	109
Bible Truth 3: They Tell Us How to Love God and Others	163
Bible Truth 3 Overview	165
Story	167
Big Question and Answer Sign	173
Unit 7 All Bible Truths Sign	175
Bible Truth 3 Concept Sign	177
Bible Verse Sign	179
Detective Dan’s Listening Assignment #1	181
Detective Dan’s Listening Assignment #2	183
Detective Dan’s Listening Assignment #3	185
Story Scenes	193

Table of Contents, continued

Other Visual Aids	245
Making a Big Question Box/Briefcase	246
Making a Flannelgraph Storyboard	247
Making Durable Storyboard/Story Scene Pictures	247
Making the Deep Down Detectives Bible Folder	248
Deep Down Detectives Bible Folder Picture Front Cover	249
Deep Down Detectives Bible Folder Picture Back Cover	251

About the Deep Down Detectives Visual Aids

How Are They Used?



The Deep Down Detectives Visual Aids book is a companion resource to be used alongside the Deep Down Detectives Core Curriculum book for each unit. These colorful pictures are used in presenting the key concepts; telling the Bible stories; and, in playing the Bible Story Review games.

What Do They Include?



There are four different resources included in this book:

- 1. Key Concept Visual Aids**-- colorful signs of the Big Question and Answer, the Bible Truth, the Bible verse, and the Listening Assignments to use with the 3 lessons for each Bible Truth.
 - 2. The Story Scenes Placement Page**--where to place the pictures on your storyboard.
 - 3. The Story Scenes, themselves.** Notice that each scene is numbered and that there is a brief summary of the story that corresponds to the picture. You can actually just tell the story in a simple way by using only the text at the bottom of each Story Scene.
 - 5. Directions** for making the Deep Down Detectives "Bible" Folder and the **back/front images** to paste in place when making it. (Larger back/front images are found online with the curriculum.)
- Directions** for how to make a homemade flannelgraph storyboard and sturdy Story Scene pictures are found in the back of this book.

Ready, Set, Rip It Out!

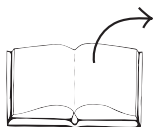

This book is meant to be ripped up and made into your visual aids. The key concept signs can be cut out and laminated or slipped into sheet protectors. The Story Scenes can be put in sheet protectors or laminated, too.

Store It!



Deep Down Detectives is a curriculum that can be used over and over. Store your visual aids and storyboard pictures after using them and they will serve you for many years. We store ours in manilla envelopes and then put them (along with all the rest of the curriculum) in magazine files, labelled by Bible Truth. If you have multiple classes using the curriculum, store each set of resources in separate manilla envelopes. This will make prep much simpler, second time around.

Replacement Story Scene Pictures



You can always purchase this book again or simply go online and print out any scenes that go missing.

Other Options

You can also choose to tell the story in a more traditional flannelgraph way by using your own flannelgraph figures or by purchasing/free downloading the Storyboard Pictures (large and small format size available). This is more complex and requires more preparation, but some love it. And, it does allow for kids to interact more by helping to place pictures up on the board as you tell the story.

Deep Down Detectives Curriculum Resources

There are five companion resources for each of the sixteen units of Deep Down Detectives. Use whichever resources are useful to your setting. Deep Down Detectives resources are available as free, digital downloads at praisefactory.org, or for purchase as hard copies through amazon.com.

Make sure to check out the “Bits and Pieces” section of the Deep Down Detectives curriculum online. It has all of the resources separated out making it easy for you simply to pick, choose and print out whatever you want.

Deep Down Detectives Core Curriculum Book, ESV/NIV for each unit

The Deep Down Detectives Core Curriculum book contains the curriculum introduction, the lesson plans, stories, music, activities and take home sheets for each of the units.

Deep Down Detectives Visual Aids with Simple Story Scenes, ESV/NIV for each unit

This resource provides large, colorful signs of the key concepts used in the unit, PLUS, easy-to-use, colorful scenes that you hold up in sequence as you tell the story. The story text for each scene is printed on the bottom of each scene.

Deep Down Detectives Simple Story Scenes, ESV/NIV for each volume

This resource includes only 2-page overview for Bible Truth, the story scenes, and take home sheets. This is a great, basic resource for use at home and in many classroom teaching situations.

Deep Down Detectives Small Format Visual Aids, ESV/NIV (Small Format Storyboard Pictures) for each volume

This resource provides large, colorful signs of the key concepts used in the unit, PLUS, colorful storyboard (flannelgraph) pictures to cut out and use as you tell each story. These storyboard pictures are for use with storyboards at least 24" x 36" in size.

Deep Down Detectives Large Format Visual Aids, ESV/NIV (Large Format Storyboard Pictures) for each volume

This resource provides large, colorful signs of the key concepts used in the unit. It also provides colorful storyboard (flannelgraph) pictures to cut out and use as you tell each story. These storyboard pictures are for use with storyboards 36" x 48" in size.

All of these materials may be photocopied for non-commercial church, classroom or school use by licensed users.

Other Resources in the Praise Factory Family of Curriculum

Deep Down Detectives is the second in a family of three, inter-related curriculums:

- Hide 'n' Seek Kids (focus group: ages 2-4; adaptable range: ages 2-pre-K 5's)
- Deep Down Detectives (focus group: ages 4-6's; adaptable range: ages 3-2nd grade)
- PFI: (focus group: grades K-5th grade; adaptable range: pre-K 5's-6th grade)

Each curriculum teaches the same biblical themes, but are presented in greater depth as the children grow and develop. Together, the curriculums work like an expanding spiral of truth that returns to reinforce the same truths with each curriculum, yet leading the children to deeper understanding with each step up.

Learn more about these curriculums as well as other resources and ideas for reaching children with the gospel at: www.praisefactory.org.

DEEP DOWN DETECTIVES



Visual Aids

Unit 7,

Bible Truth 1

About the Deep Down Detectives Visual Aids

How Are They Used?



The Deep Down Detectives Visual Aids book is a companion resource to be used alongside the Deep Down Detectives Core Curriculum book for each unit. These colorful pictures are used in presenting the key concepts; telling the Bible stories; and, in playing the Bible Story Review games.

What Do They Include?



There are four different resources included in this book:

- 1. Key Concept Visual Aids**-- colorful signs of the Big Question and Answer, the Bible Truth, the Bible verse, and the Listening Assignments to use with the 3 lessons for each Bible Truth.
 - 2. The Story Scenes Placement Page**--where to place the pictures on your storyboard.
 - 3. The Story Scenes, themselves.** Notice that each scene is numbered and that there is a brief summary of the story that corresponds to the picture. You can actually just tell the story in a simple way by using only the text at the bottom of each Story Scene.
 - 5. Directions** for making the Deep Down Detectives "Bible" Folder and the **back/front images** to paste in place when making it. (Larger back/front images are found online with the curriculum.)
- Directions** for how to make a homemade flannelgraph storyboard and sturdy Story Scene pictures are found in the back of this book.

Ready, Set, Rip It Out!

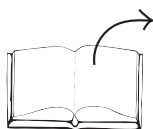

This book is meant to be ripped up and made into your visual aids. The key concept signs can be cut out and laminated or slipped into sheet protectors. The Story Scenes can be put in sheet protectors or laminated, too.

Store It!



Deep Down Detectives is a curriculum that can be used over and over. Store your visual aids and storyboard pictures after using them and they will serve you for many years. We store ours in manilla envelopes and then put them (along with all the rest of the curriculum) in magazine files, labelled by Bible Truth. If you have multiple classes using the curriculum, store each set of resources in separate manilla envelopes. This will make prep much simpler, second time around.

Replacement Story Scene Pictures



You can always purchase this book again or simply go online and print out any scenes that go missing.

Other Options



You can also choose to tell the story in a more traditional flannelgraph way by using your own flannelgraph figures or by purchasing/free downloading the Storyboard Pictures (large and small format size available). This is more complex and requires more preparation, but some love it. And, it does allow for kids to interact more by helping to place pictures up on the board as you tell the story.

Unit 7: The Law-Giving God

Unit Big Question (and Answer): What Are God's Laws Like? God's Laws Are Perfect!

Unit Bible Verse: "The law of the LORD is perfect." Psalm 19:7

Bible Truth 1 Concept: God's Laws Are Perfect... They Are Written in the Bible, God's Word!

A law is big rule that we are supposed to obey. God told His laws to godly people long ago. These people wrote them down in the Bible, God's Word, so everyone can know them. God's Holy Spirit helped them write them down just right.

God's laws are the most important laws of all. They are rules that God wants everyone to keep. That's why God's people take time to learn God's laws and ask Him to help them obey them. They love God and want to please Him. They want to show the world what God is like by living the way He wants us to live.

Bible Truth 1 Bible Verse: Deuteronomy 5:1,7-21

"Hear, O Israel, the statutes and the rules that I speak in your hearing today, and you shall learn them and be careful to do them... You shall have no other gods before me. You shall not make for yourself a carved image. You shall not bow down to them or serve them... You shall not take the name of the LORD your God in vain... Observe the Sabbath day, to keep it holy... Honor your father and your mother... You shall not murder. And you shall not commit adultery. And you shall not steal. And you shall not bear false witness... And you shall not covet... anything that is your neighbor's."

Learn a Little: "Hear the rules... learn them and be careful to do them."

Meaning

Long ago, the LORD gave the 10 Commandments and many other good laws to the people of Israel. The Israelites promised to keep them. He would be their God; they would be His people. He would bless them and take care of them. These verses are the Ten Commandments (laws) that God gave them. But even though God gave these laws to the people of Israel that day, they are laws for all of us to keep. They tell us how God wants us all to live.

Bible Truth 1 ACTS Prayer

- A** We praise You, God, for being the Giver of Your perfectly good laws.
- C** God, we confess that we break Your good laws. Sometimes, we do not obey our parents. Sometimes, we lie. Sometimes, we want things that belong to others. You made us to be law keepers, but we are all lawbreakers. We need a Savior!
- T** Thank You for giving us Your good laws, so we know how to love and obey You. Thank You for making sure they were written down just right in Your Word, the Bible. Thank You for sending Jesus to keep Your laws perfectly and make the way for people like us to be forgiven.
- S** God, work in our hearts. Help us to turn away from our sins and trust in Jesus as our Savior. Help us to learn Your good laws and obey them. Help us to love You by living for You and keeping Your good laws.

In Jesus' name we pray, Amen.

Bible Truth 1 Story**The Case of the Big Ten**

Deuteronomy 5:1,7-21

Songs Used in Bible Truth 1

Big Q & A 7 Song

Big Question 7 Song: What Are God's Laws Like?

Big Question 7 Bible Verse Song: The Law of the Lord Psalm 19:7, ESV

Extra Big Question 7 Bible Verse Song: The Law of the Lord Is Perfect Psalm 19:7, ESV (full version)

Big Question 7 Hymn: Holy Bible, Book Divine

Big Question 7 Praise Song: The Best Book to Read Is the Bible

Bible Truth 1 Bible Verse Song: Hear, O Israel Deuteronomy 5:1,7-21 , ESV

listen to or download songs for free at <https://praisefactory.org>: Deep Down Detectives Music page

The Case of the Big Ten

Exodus 16,19,20



of BQB

Story-telling Tips

Ahead of time:

1. Read the Bible verses and story. Pray!
2. Choose story action cues and/or prepare storyboard figures, if using. (Included in Visual Aids book)
3. Practice telling story with the storyboard pictures, timing your presentation. Shorten, if necessary.

During your presentation:

1. Maintain as much eye contact as possible as you tell the story.
2. Put up storyboard figures/add story action cues as you tell the story. Allow the children to help you put them on the board, if desired.
3. Include the children in your story with a few questions about what they think will happen or words/concepts that might be new to them.
4. Watch the kids for signs that their attention span has been reached. Shorten, if necessary.

INTRODUCTION/ LISTENING ASSIGNMENTS

“Our story is called: The Case of the Big Ten. Here is your listening assignment.” Read from Detective Dan’s Listening Assignment signs, but questions are summarized below:

Detective Dan’s Lesson #1 Listening Assignment:

I need to find out:

- 1. What were the “Big Ten”? What made them so big?**
- 2. To whom did God give the “Big Ten” to obey?**

Detective Dan’s Lesson #2 Listening Assignment:

Our Bible Verse is Deuteronomy 5:1,7-21

“Hear, O Israel, the statutes and the rules that I speak in your hearing today, and you shall learn them and be careful to do them... You shall have no other gods before me. You shall not make for yourself a carved image. You shall not bow down to them or serve them... You shall not take the name of the LORD your God in vain... Observe the Sabbath day, to keep it holy... Honor your father and your mother... You shall not murder. And you shall not commit adultery. And you shall not steal. And you shall not bear false witness... And you shall not covet... anything that is your neighbor’s.”

I need to find out:

- 1. How did God tell the people of Israel these Ten, Big Rules?**
- 2. Why did the people need to know these rules?**

Detective Dan’s Lesson #3 Listening Assignment:

I found six clues, but only 4 of them are in the story.

Our six clues were: a mountain called Sinai, laws written in stone, a tree, clean clothes, a tent, and an airplane. Hold each of them up for the children to see as you identify them.

I need to figure out:

- 1. Which four belong in the story and which two don’t?**
- 2. What did the “Big Ten” laws show the people of Israel they needed to ask God to give them?**

Read the assignment questions, THEN SAY,

“Ok, Deep Down Detectives! Put on your best listening ears and see if you can hear the answers to Detective Dan’s questions. When I finish telling the story, we will see if we can answer all the questions.”

Read the Bible Truth story, answer questions, present the gospel and lead in prayer.

Answers to questions; the gospel; and, ACTS prayer are included with the story text.

The Case of the Big Ten *Exodus 16,19,20*

Story with lines separating paragraphs (text in bold, optional interaction cues in italics)

“Praise the LORD! He is the great, one, true God,” the Israelites shouted. They had so much to celebrate! God had freed us from their enemies, the Egyptians. He was taking them to a new home, a very special place called the Promised Land. Moses would lead them there. How happy the Israelites were! Life would be good in God’s Promised Land.

But before they could go to their new, beautiful home, there was somewhere else they had to go: to great Mt. Sinai, out in the desert. It was there the LORD would meet with them.

Can you guess what He wanted to do?

The LORD was going to make them His people. The LORD would promise to always take care of them and give them everything they needed. The people would promise to love and obey Him. This is how the people would become God’s people. This is how they could live happily with the LORD and each other in the Promised Land. First, must come the promises; then, the Promised Land.

So tramp, tramp, tramp, they went, across the dry, dusty wilderness. How very hot the sun was, as it beat down on them! There was hardly a cloud in the sky, or a tree on the ground, to give them any shade. Day after day they traveled until at last, they reached Mt. Sinai --the very mountain where Moses had first met with the LORD.

And in the shadow of that mountain, they set up their camp. As they worked, Moses headed to the mountain. What was he going to do?

What do you think he was going to do?

Moses was climbing up to meet with the LORD.

“It’s time to get the people ready to meet Me,” the LORD told Moses. **“I am holy, and the people are not. I can only meet with them if they are very, very careful. Tell them to set up fences around the bottom of this mountain, so that no animal or person will step foot on it. Have everyone take a bath and wash their clothes. Tell them to prepare their hearts for My coming,”** the LORD told Moses. **“And tell them to do this in the next two days. On the third day, I will come to them.”**

Moses went back down the mountain and told the people what the LORD had said. There was much to do in two days! All that fence had to be put in place! All those people needed to take baths and wash their clothes! All those hearts must be made ready for the LORD!

Day One passed, then Day Two. Everything was completed. How exciting it must have been as everyone went to bed that second night! The LORD would meet with them the very next day. What would it be like?

What do you think it would be like?

Soon they would know!

Yes, sure enough, the next morning they found out. Sinai was usually a land of bright sunshine and cloudless days, but not this day. The people awoke to the sound of loud rumbles of thunder and a blaring trumpet blast. They peered out of their tents to find Mt. Sinai covered in thick clouds with great flashes of lightning. Everyone trembled with fear.

Story with lines separating paragraphs (text in bold, optional interaction cues in italics)

Moses led the people out of the camp to the very foot of Mt. Sinai. They watched great, billowing clouds of smoke rise as the LORD descended on the top of the mountain in fire. They could feel the ground under their feet move as the whole mountain shook. The LORD, the one, true God, had come to meet with them! Moses went up the mountain to talk with the LORD.

The trumpet blasted louder and louder, as the LORD and Moses spoke together on the mountain. Then, after making sure the people stayed off the mountain one last time, the LORD spoke in a loud voice for all the people to hear. This is what He said to them:

"I am the LORD your God who rescued you from your enemies, the Egyptians. I want to make special promises to you. I will love you and take care of you. You will be My people. But you must make special promises to Me, too. You must keep My laws if you are to be My people. Here are My laws:

Worship Me alone. Don't make gods out of anything you see, in the sky or on the earth around you. Worship Me alone. I am the LORD. Honor My name. Don't misuse it. Keep one day a week (the Sabbath day) a day of worship and rest. Honor your father and mother. Listen to them and obey them. Don't murder anyone. Don't treat someone else's husband or wife as if they are yours. Don't steal and don't lie. Don't covet. Don't keep longing after something someone else has that you want. Be happy with what I give you."

Do you know what we call these Ten, Big Laws of the LORD?

Can you tell me?

They are called the Ten Commandments.

When the people they saw the lightning and the whole mountain in smoke and fire, and they heard the crashing thunder, the loud, heavenly trumpet, and the voice of God, Himself, how do you think they felt?

What do you think?

They trembled with fear! They stayed away from the mountain and said to Moses, "Speak to us yourself and we will listen. We will do whatever the LORD wants us to do. We want to be His people. But do not have Him speak to us. We are afraid we will die, we are so scared by His mightiness and holiness," they exclaimed.

"Don't be afraid," Moses told them. "The LORD hasn't come to hurt you. He has come in this mighty way so you will know what He is like and so you will not want to break the good laws He is giving you," he explained. "But I will go and meet with God for you, then I will come back down and tell you what He says."

Away went Moses once more. The people watched as he climbed up Mt. Sinai and disappeared in the thick, dark cloud to meet with the LORD. Up on the mountain, the LORD, Himself, wrote His 10 Big, Laws into pieces of stone and gave them to Moses. Then, the LORD told Moses many other laws to teach the people, so they could know how to love Him and love each other. "Write down all these laws, so the people will always know how to love and obey Me," the LORD said.

And that was what Moses did. He wrote down all of the LORD's good laws in Bible. God had Moses write them down, so that not just the Israelites, but all peoples, in all times, could know God's laws and how God's people should live. And, so that by those laws, we could get ready for the Savior. How? By showing us that none of us live as God requires. We all need a Savior, if we are to be God's people. That Savior was Jesus, God's very own Son! Jesus came and lived a perfect life. Only He obeyed all of God's laws. He gave His life as the full payment for the sins of all who turn away from their sin and trust in Him as their Savior. He died on the cross for them and rose from the dead in victory! Through Jesus, we can become God's people.

Cracking the Case: (story wrap-up for Listening Assignments)

It's time to see how we did with our Listening Assignment.

Detective Dan's Lesson 1 Listening Assignment:**1. What were the "Big Ten"? What made them so big?**

The "Big Ten" were the Ten Commandments that the LORD gave the people of Israel at Mt. Sinai that day. We call them BIG because they are so important. They are the laws behind all of the other laws the LORD would give. They tell us how to love the LORD and love each other.

2. To whom did God give the "Big Ten" to obey? The LORD first gave them to the people of Israel, but they are laws for all of us to obey.

For You and Me:

The LORD wants all of us to obey His good laws. They are for us all to live by. But sadly, we all break them. That's why God sent Jesus to save us. He, alone, kept God's laws perfectly. Jesus gave His life as the full payment for the sins of God's people when He suffered and died on the cross. On the third day, Jesus rose from the dead in victory. He had beaten sin and death for God's people. How can we become God's people? By turning away from our sins and trusting in Jesus as our Savior. Ask Him to help you! He delights to do this!

Detective Dan's Lesson 2 Listening Assignment:**Our Bible Verse is Deuteronomy 5:1,7-21, ESV**

"Hear, O Israel, the statutes and the rules that I speak in your hearing today, and you shall learn them and be careful to do them... You shall have no other gods before me. You shall not make for yourself a carved image. You shall not bow down to them or serve them... 'You shall not take the name of the LORD your God in vain... Observe the Sabbath day, to keep it holy... Honor your father and your mother... You shall not murder. And you shall not commit adultery. And you shall not steal. And you shall not bear false witness... And you shall not covet... anything that is your neighbor's."

1. How did God tell the people of Israel these Ten, Big Rules? He met with them at Mt. Sinai. He spoke to them, Himself, out of a dark, thick cloud from the mountain. He, Himself, wrote them down on stone tablets for them to have.

2. Why did the people need to know these rules?

They needed to know them, so they could obey them. This was part of making special promises with God to become His people.

For You and Me:

All of us need to know God's Ten Commandments. God wants us to keep them if we are to be His people. But the sad truth is that none of us can ever keep God's laws as He wants us to. That's why we need a Savior if we are to be God's people. That Savior is Jesus. Jesus, God's Son, lived a perfect life. He always kept all of God's laws. Jesus gave His life as the full payment for the sins of God's people when He suffered and died on the cross. On the third day, Jesus rose from the dead in victory. He had beaten sin and death for God's people. How can we become God's people? By turning away from our sins and trusting in Jesus as our Savior. Ask Him to help you! He delights to do this!

Detective Dan's Lesson 3 Listening Assignment:

Our six clues were: a mountain called Sinai, laws written in stone, a tree, clean clothes, a tent, and an airplane.

1. Which four belong in our story?

The mountain, the laws, the clean clothes and the tent belong.

2. What did the "Big Ten" laws show the people of Israel they needed to ask God to give them? They needed to ask God to give them a Savior because they could never obey God's laws as they should.

For You and Me:

The people of Israel needed a Savior and the LORD sent them one: Jesus, His very own Son! Jesus lived a perfect life. He always kept all of God's laws. Jesus gave His life as the full payment for the sins of God's people when He suffered and died on the cross. On the third day, Jesus rose from the dead in victory. He had beaten sin and death for God's people. How can we become God's people? By turning away from our sins and trusting in Jesus as our Savior. Ask Him to help you! He delights to do this!

The Gospel (story wrap-up if NOT using Listening Assignments)

Our Bible Truth is:

What Are God's Laws Like?

God's Laws Are Perfect...

"They Are Written in the Bible, God's Word!"

God gave us His laws in His Word, the Bible, so we could know how to live lives that please Him. But even though we know God's laws, we do not keep them, do we? No, we all break them. We choose to disobey God and we all deserve God's punishment for our sins! How sad! God would have been perfectly fair to give us all the punishment we deserve for breaking His laws. He is holy and good. But God is so rich in mercy. He chose to give us something better than we deserve. He sent His Son Jesus to live a perfect life. Yes! Jesus kept every, single one of God's laws! And on the cross, He suffered and died, giving His perfect life as the full payment for the sins of all who turn away from their sins and trust in Him as their Savior. On the third day, Jesus rose from the dead. He had really beaten sin and death! Because of Jesus, all who trust in Him as their Savior get to enjoy wonderful, special closeness with God as His special people, even now. And one day, they will go to live with Him forever. We can be God's people when we turn from our sins and trust in Jesus. Ask Him to help you! He loves to do this! *Close in prayer.*

Closing ACTS Prayer

- A** We praise You, God, for being the Giver of Your perfectly good laws.
- C** God, we confess that we break Your good laws. Sometimes, we do not obey our parents. Sometimes, we lie. Sometimes, we want things that belong to others. You made us to be law keepers, but we are all lawbreakers. We need a Savior!
- T** Thank You for giving us Your good laws, so we know how to love and obey You. Thank You for making sure they were written down just right in Your Word, the Bible. Thank You for sending Jesus to keep Your laws perfectly and make the way for people like us to be forgiven.
- S** God, work in our hearts. Help us to turn away from our sins and trust in Jesus as our Savior. Help us to learn Your good laws and obey them. Help us to love You by living for You and keeping Your good laws. In Jesus' name we pray, Amen.

Go to Lesson Plan, p.9 for the script to the rest of the lesson.

BIG QUESTION 7



What are God's laws like?

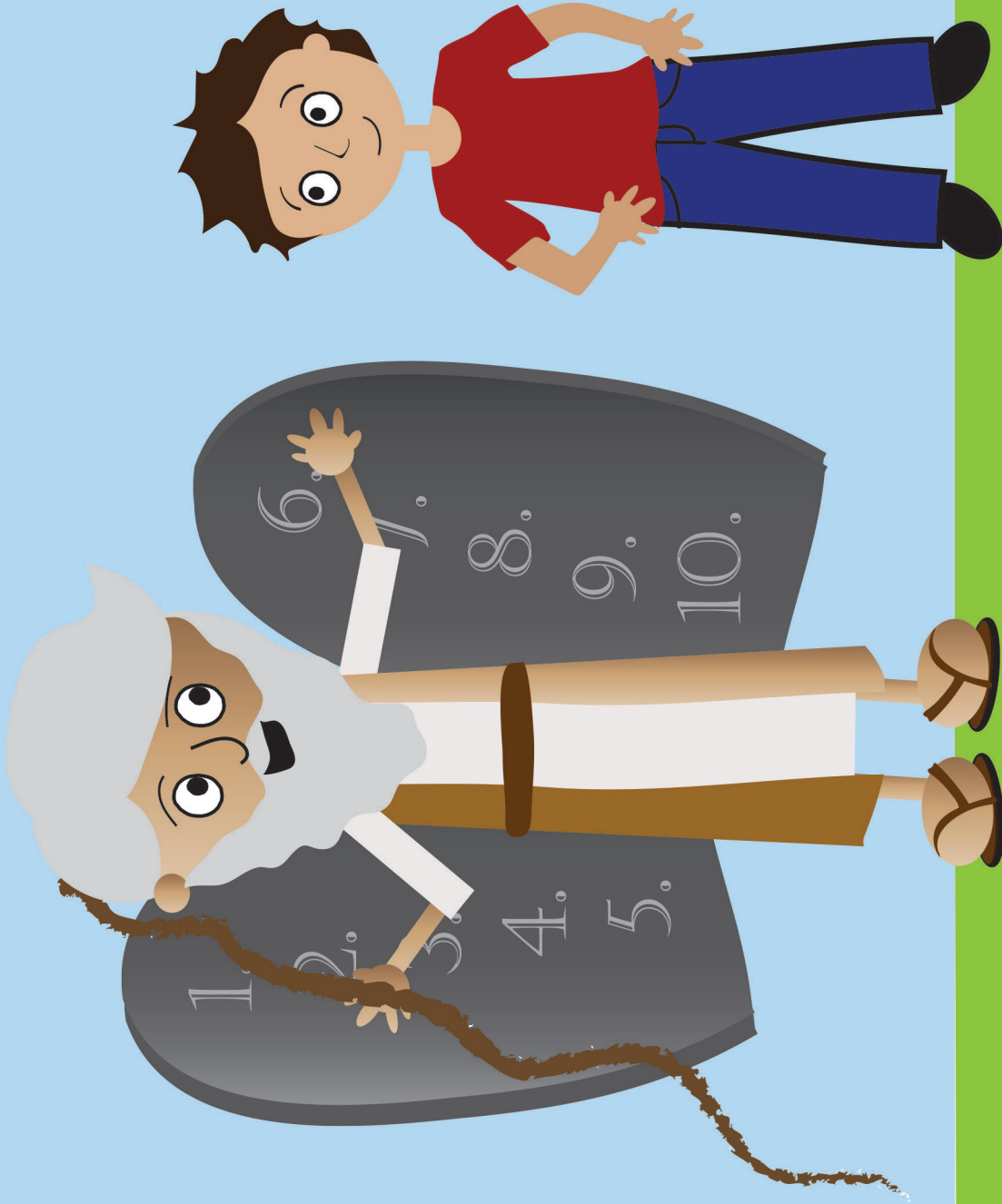

ANSWER:

God's laws are perfect!

VISUAL
AID

#1

take out



The Big Question

Hold up the Big Question sign for all the children to see, and say:

The Big Question we are investigating today is
Big Question Number 7:

What Are God's Laws Like?

and the Answer is:

God's Laws Are Perfect!

Meaning:

A law is a big rule made by someone in charge. God is our Maker. He is in charge of everyone in the whole world. He has given us His laws to live by.

God is good and loving, wise and fair. He is perfect! God's laws are just like Him. They are good and loving, wise and fair, too. They are perfect!

God's laws show us the very best way to live. They show us how to love God and love others. They are exactly what we need.

Let's sing our Big Question Song: "

Big Q & A 7 Song

DDD ESV Songs 7, track 12

(adapted version of "The Farmer in the Dell")

What are God's laws like?
What are God's laws like?
What are God's laws like?
God's laws are perfect!

BIG QUESTION 7: Three truths about God's laws

Visual Aid #2
take out
Big Question
Bible.com
of BQB

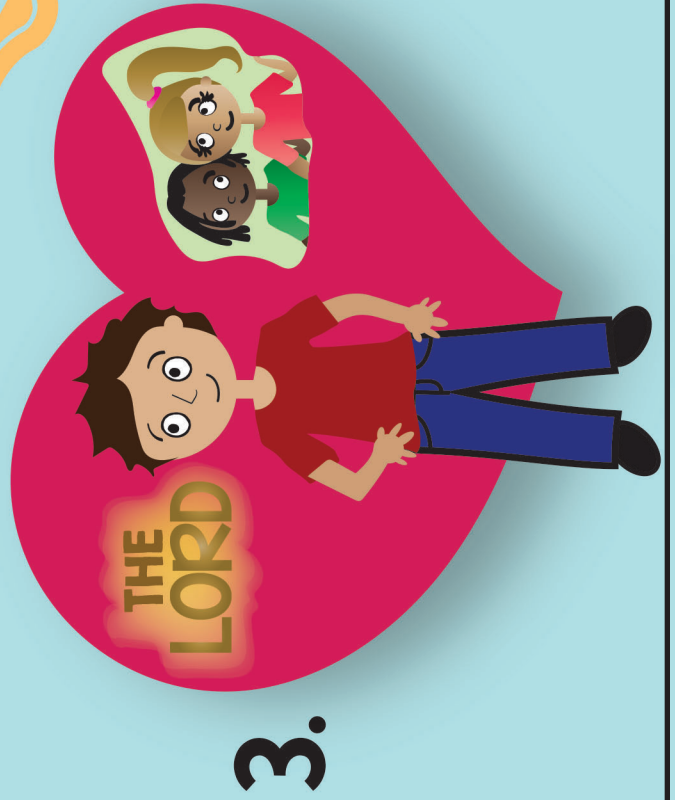
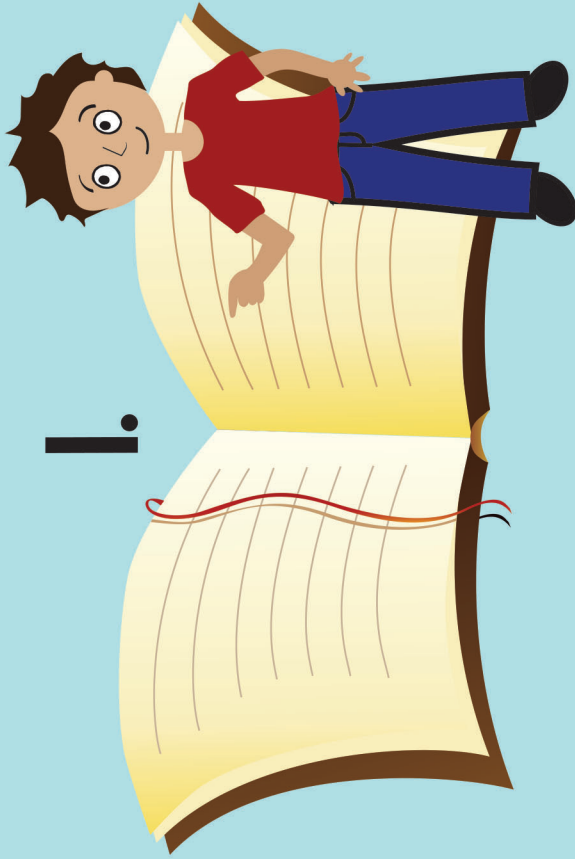

This Unit's Bible Truths

"God's laws are perfect is a good beginning, but there's so more to learn. So it's time for us to dig down even deeper for more answers to our Big Question about God. We're going to be learning THREE Bible truths that all tell us more about God's perfect laws.

Who would like to hand me the picture with our three Bible truths on it? It's in the Big Question Box/Briefcase."

Choose a child to get it and hand it to you, then hold it up and show them the pictures of the three truths they will be learning. After everyone has had a good look, say...

"Ok, now let's look at our Bible Truth Clue sign and see if we can figure out which of these three truths we will be learning about today. Who would like to get it out of the Big Question Briefcase for me?"

Choose a child to open the briefcase, take out the Bible Truth Clue sign and hand it to you.

CAN YOU GUESS BIBLE TRUTH?

**What Are God's Laws Like?
God's Laws Are Perfect...
They are written in
the ????, God's Word!**

**HINT: "What is the
name of God's Word?
It starts with an "B."**

**ANSWER:
They are written in BIBLE, God's Word!**

Visual Aid

#3

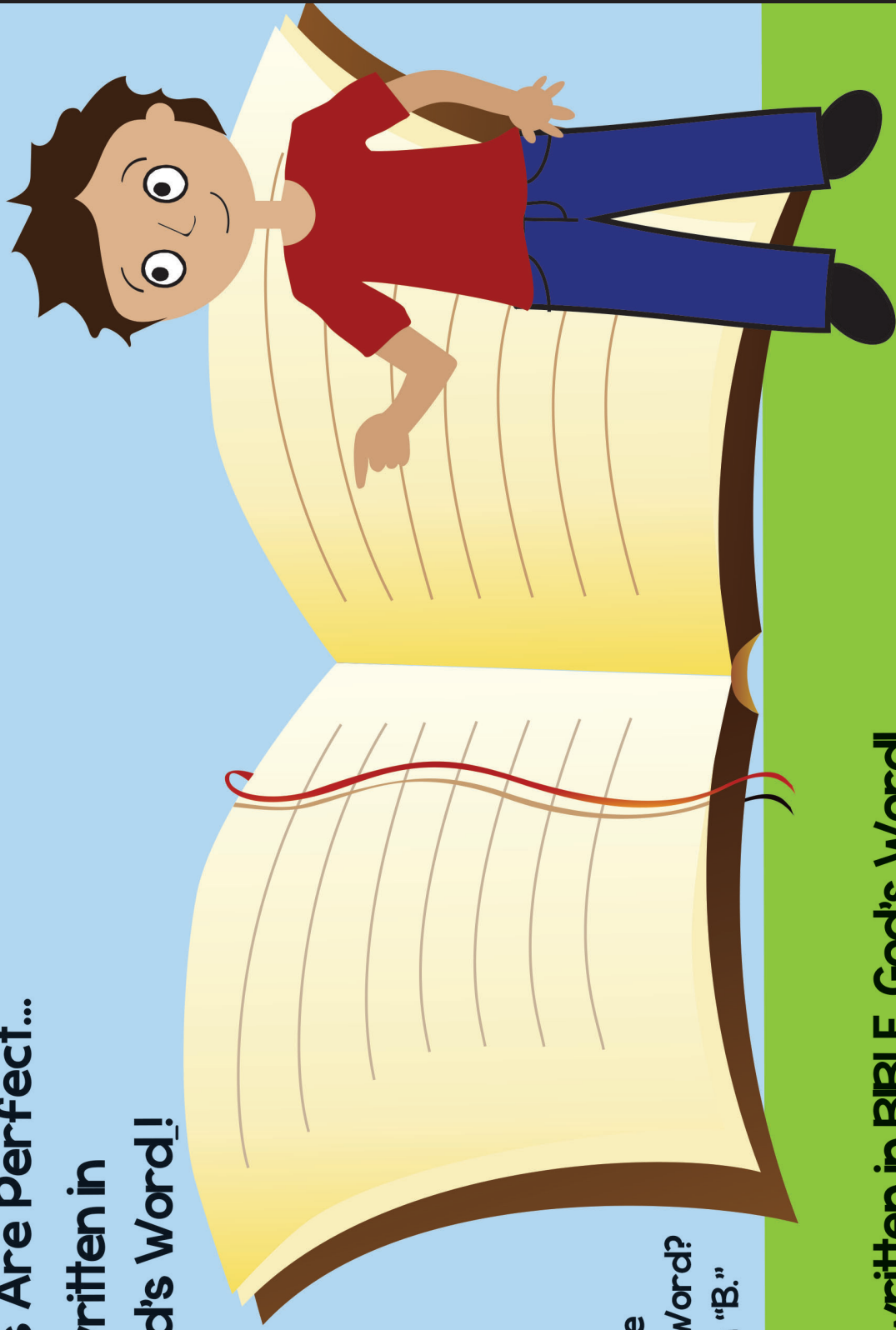

Revealing the Bible Truth

We Are Learning

Hold up the front side for the children to see. Cover up the answer, written along the bottom, and say:

**“What Are God’s Laws Like?
God’s Laws Are Perfect!
They are Written in the ????, God’s Word!”**

We’re missing one word. Here’s the hint to what the missing word is. It says: “What’s the name of God’s Word? It starts with a “B.”

Can you guess? It’s “Bible.”

So the Bible Truth we are learning today is:

(uncover answer from bottom of sign, show it to them and say:)

**“What Are God’s Laws Like?
God’s Laws Are Perfect!
They are Written in the BIBLE, God’s Word!”**

And here is what this Bible Truth means:

(read the meaning off of the back of the sign, say:)

A law is big rule that we are supposed to obey. God told His laws to godly people long ago. These people wrote them down in the Bible, God’s Word, so everyone can know them. God’s Holy Spirit helped them write them down just right.

God’s laws are the most important laws of all. They are rules that God wants everyone to keep. That’s why God’s people take time to learn God’s laws and ask Him to help them obey them. They love God and want to please Him. They want to show the world what God is like by living the way He wants us to live.

I AM LORD



1. Love Me most of all



3. Love Me by how you talk about Me and how you live



5. Love and obey your mother and father



2. Don't worship fake gods.

Worship only Me

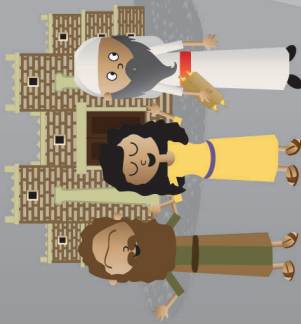

4. Keep a special day to rest and to worship Me



8. Don't take other people's things



6. Don't murder people



7. Keep your promise to love only your husband/wife



9. Don't Lie



10. Be happy with what I give you. Don't be greedy for what others have

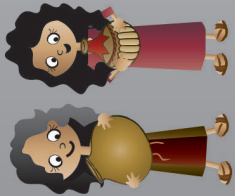

10. Be happy with what I give you. Don't be greedy for what others have

"Hear, O Israel, the statutes and the rules that I speak in your hearing today, and you shall learn them and be careful to do them... You shall have no other gods before me. You shall not make for yourself a carved image. You shall not bow down to them or serve them... 'You shall not take the name of the LORD your God in vain... Observe the Sabbath day, to keep it holy... Honor your father and your mother... You shall not murder. And you shall not commit adultery. And you shall not steal. And you shall not bear false witness... And you shall not covet... anything that is your neighbor's." Deuteronomy 5:1,7-21 ESV

Bible Truth | Bible Verse

Remove the Bible Verse Picture from the "Bible" folder and hold it up for all the children to see, then say:

Deuteronomy 5:1,7-21 tells us:

Deuteronomy 5:1,7-21, ESV

"Hear, O Israel, the statutes and the rules that I speak in your hearing today, and you shall learn them and be careful to do them... You shall have no other gods before me. You shall not make for yourself a carved image. You shall not bow down to them or serve them... You shall not take the name of the LORD your God in vain... Observe the Sabbath day, to keep it holy... Honor your father and your mother... You shall not murder. And you shall not commit adultery. And you shall not steal. And you shall not bear false witness... And you shall not covet... anything that is your neighbor's."

Learn a Little: "Hear the rules... learn them and be careful to do them."

What does that mean?

Long ago, the LORD gave the 10 Commandments and many other good laws to the people of Israel. The Israelites promised to keep them. He would be their God; they would be His people. He would bless them and take care of them. These verses are the Ten Commandments (laws) that God gave them. But even though God gave these laws to the people of Israel that day, they are laws for all of us to keep. They tell us how God wants us all to live.

"We've said our Bible verse, now let's sing it!"

Hear, O Israel

Deuteronomy 5:1,6-21

DDD ESV Songs 7, tracks 19,20

Refrain:

Hear, O Israel, the statutes and rules I speak,
Learn them and be careful to do them,
Be careful to do them.

You shall have no gods before Me,
You shall not make a carved image,

You shall not bow down or serve them.

You shall not take the name of the Lord in vain,
Observe the Sabbath day,

Honor your father and mother. Refrain

You shall not murder,

You shall not commit adultery,

You shall not steal,

You shall not bear false witness

Against your neighbor,

You shall not covet anything. Refrain

Deuteronomy Five,

Verses one, six through twenty-one.

"Now it's time to do a bit more deep down investigating. Let's see what Detective Dan wants us to help him figure out. Would someone like to get it out for me?"

take out



Place in



Visual Aid



Detective Dan's Listening Assignment #1

Detective Dan's Listening Assignment #1



Hi, Deep Down Detectives!
I'm working on a brand-new case called:
"The Case of the Big Ten."

I need to find out:

1. What were the "Big Ten"?
- AND
2. To whom did God give the "Big Ten" to obey?

Can you help me? Listen carefully to the story and you might just hear the answers!

Thanks!
Detective Dan

Then say, "Ok, Deep Down Detectives! Put on your best listening ears and see if you can hear the answers to Detective Dan's questions. When I finish telling the story, we will see if we can answer all of his questions."

Read the Bible Truth story, putting up the storyboard pictures as you tell it.

At the end of the story, repeat the questions and lead the children in answering them. Present the gospel and close in prayer.

Answers to assignment questions, the gospel and ACTS prayer are also included at the end of the story text.

Answers:

1. What were the "Big Ten"? What made them so big?

The "Big Ten" were the Ten Commandments that the LORD gave the people of Israel at Mt. Sinai that day. We call them BIG because they are so important. They are the laws behind all of the other laws the LORD would give. They tell us how to love the LORD and love each other.

2. To whom did God give the "Big Ten" to obey?

The LORD first gave them to the people of Israel, but they are laws for all of us to obey.

For You and Me:

The LORD wants all of us to obey His good laws. They are for us all to live by. But sadly, we all break them. That's why God sent Jesus to save us. He, alone, kept God's laws perfectly. Jesus gave His life as the full payment for the sins of God's people when He suffered and died on the cross. On the third day, Jesus rose from the dead in victory. He had beaten sin and death for God's people. How can we become God's people? By turning away from our sins and trusting in Jesus as our Savior. Ask Him to help you! He delights to do this!

take out



Place in



Visual Aid

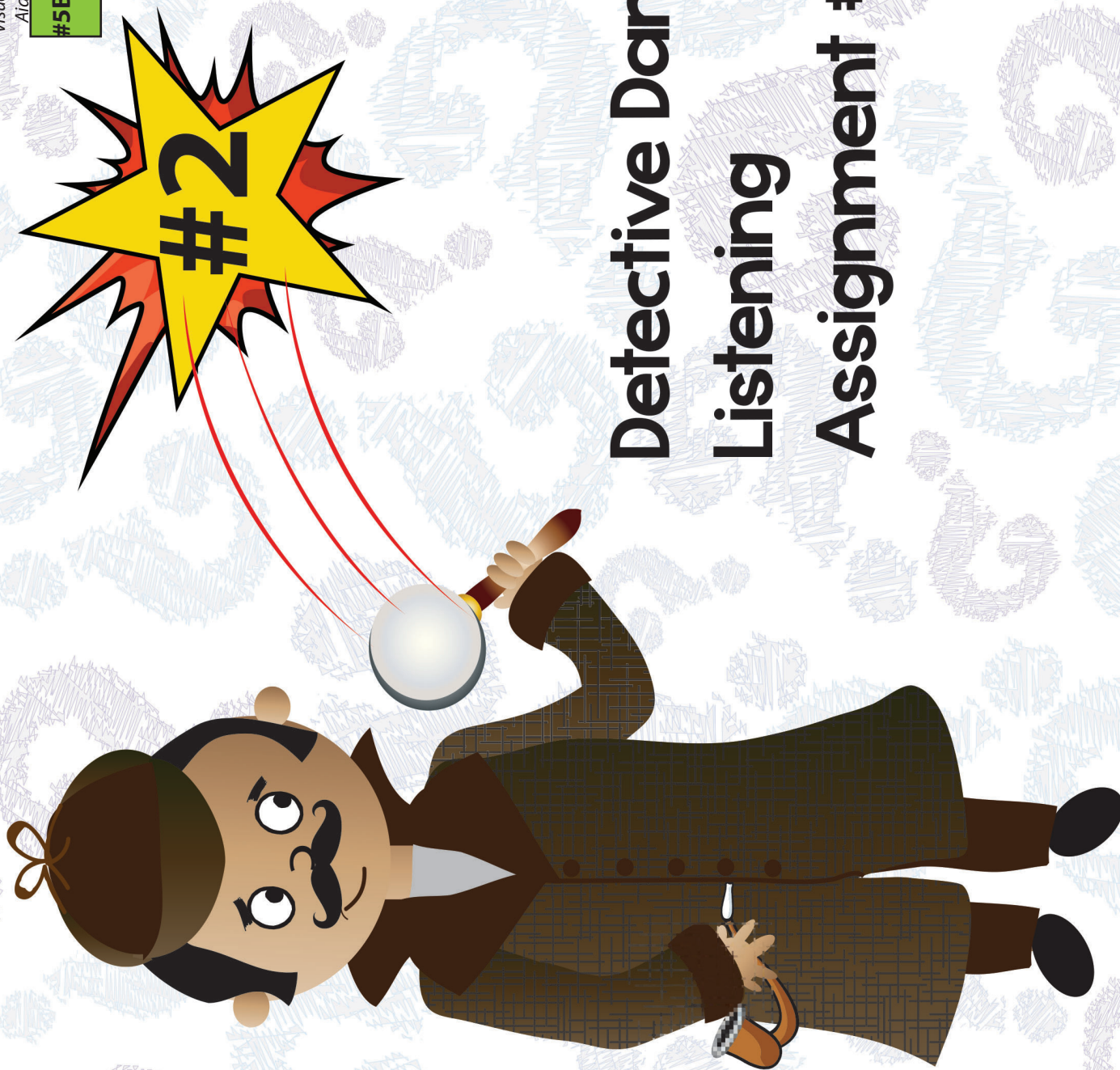

Detective Dan's Listening Assignment #2

Detective Dan's

Listening Assignment #2



Hi, Deep Down Detectives!

I'm still working on the case called:

"The Case of the Big Ten."

Our Bible verse is Deuteronomy 5:1,7-21, ESV

"Hear, O Israel, the statutes and the rules that I speak in your hearing today, and you shall learn them and be careful to do them... You shall have no other gods before me. You shall not make for yourself a carved image. You shall not bow down to them or serve them... You shall not take the name of the LORD your God in vain... Observe the Sabbath day, to keep it holy... Honor your father and your mother... You shall not murder. And you shall not commit adultery. And you shall not steal. And you shall not bear false witness... And you shall not covet... anything that is your neighbor's."

I need to find out:

1. How did God tell the people of Israel these Ten, Big Rules?

AND

2. Why did the people need to know these rules?

Can you help me? Listen carefully to the story and you might just hear the answers!

Thanks for your help!

Detective Dan

Then say, "Ok, Deep Down Detectives! Put on your best listening ears and see if you can hear the answers to Detective Dan's questions. When I finish telling the story, we will see if we can answer all of his questions!"

Read the Bible Truth story, putting up the storyboard pictures as you tell it. At the end of the story, repeat the questions and lead the children in answering them. Present the gospel and close in prayer.

Answers to assignment questions, the gospel and ACTS prayer are also included at the end of the story text.

Answers:

Our Bible Verse is Deuteronomy 5:1,7-21 ESV

"Hear, O Israel, the statutes and the rules that I speak in your hearing today, and you shall learn them and be careful to do them... You shall have no other gods before me. You shall not make for yourself a carved image. You shall not bow down to them or serve them... You shall not take the name of the LORD your God in vain... Observe the Sabbath day, to keep it holy... Honor your father and your mother... You shall not murder. And you shall not commit adultery. And you shall not steal. And you shall not bear false witness... And you shall not covet... anything that is your neighbor's"

1. How did God tell the people of Israel these Ten, Big Rules? He met with them at Mt. Sinai. He spoke to them, Himself, out of a dark, thick cloud from the mountain. He, Himself, wrote them down on stone tablets for them to have.

2. Why did the people need to know these rules? They needed to know them, so they could obey them. This was part of making special promises with God to become His people.

For You and Me:

All of us need to know God's Ten Commandments. God wants us to keep them if we are to be His people. But the sad truth is that none of us can ever keep God's laws as He wants us to. That's why we need a Savior, if we are to be God's people. That Savior is Jesus. Jesus, God's Son, lived a perfect life. He always kept all of God's laws. Jesus gave His life as the full payment for the sins of God's people when He suffered and died on the cross. On the third day, Jesus rose from the dead in victory. He had beaten sin and death for God's people. How can we become God's people? By turning away from our sins and trusting in Jesus as our Savior. Ask Him to help you! He delights to do this!

DDD 7.1 Lesson 2 Listening Assignment

take out



Place in



Visual Aid



Detective Dan's Listening Assignment #3

Detective Dan's

Listening Assignment #3



Hi, Deep Down Detectives!
I'm still working on the case called:
"The Case of the Big Ten."

I found SIX clues, but TWO of them are NOT in the story.
They are: a mountain called Sinai, laws written in stone,
a tree, clean clothes, a tent, and an airplane.

Hold up each of the six pictures for the children to see as you identify them. Better yet, put them up on your flannelgraph board, off to one side.

I need to know:

1. Which FOUR pictures belong in the story and which TWO do NOT?
2. What did the "Big Ten" laws show the people of Israel they needed to ask God to give them?

Can you help me? Listen carefully to the story and you might just hear the answers!

Thanks!

Detective Dan

Then say, "Ok, Deep Down Detectives! Put on your best listening ears and see if you can hear the answers to Detective Dan's questions. When I finish telling the story, we will see if we can answer all of his questions."

Read the Bible Truth story, putting up the storyboard pictures as you tell it. At the end of the story, repeat the questions and lead the children in answering them. Present the gospel and close in prayer.

Answers to assignment questions, the gospel and ACTS prayer are also included at the end of the story text.

Answers:

1. Which four pictures belong in the story and which two do not?
The mountain, the laws, the clean clothes and the tent belong. The airplane and the tree do not.
2. What did the "Big Ten" laws show the people of Israel they needed to ask God to give them?
They needed to ask God to give them a Savior because they could never obey God's laws as they should.

For You and Me:

The people of Israel needed a Savior and the LORD sent them one: Jesus, His very own Son! Jesus lived a perfect life. He always kept all of God's laws. Jesus gave His life as the full payment for the sins of God's people when He suffered and died on the cross. On the third day, Jesus rose from the dead in victory. He had beaten sin and death for God's people. How can we become God's people? By turning away from our sins and trusting in Jesus as our Savior. Ask Him to help you! He delights to do this!

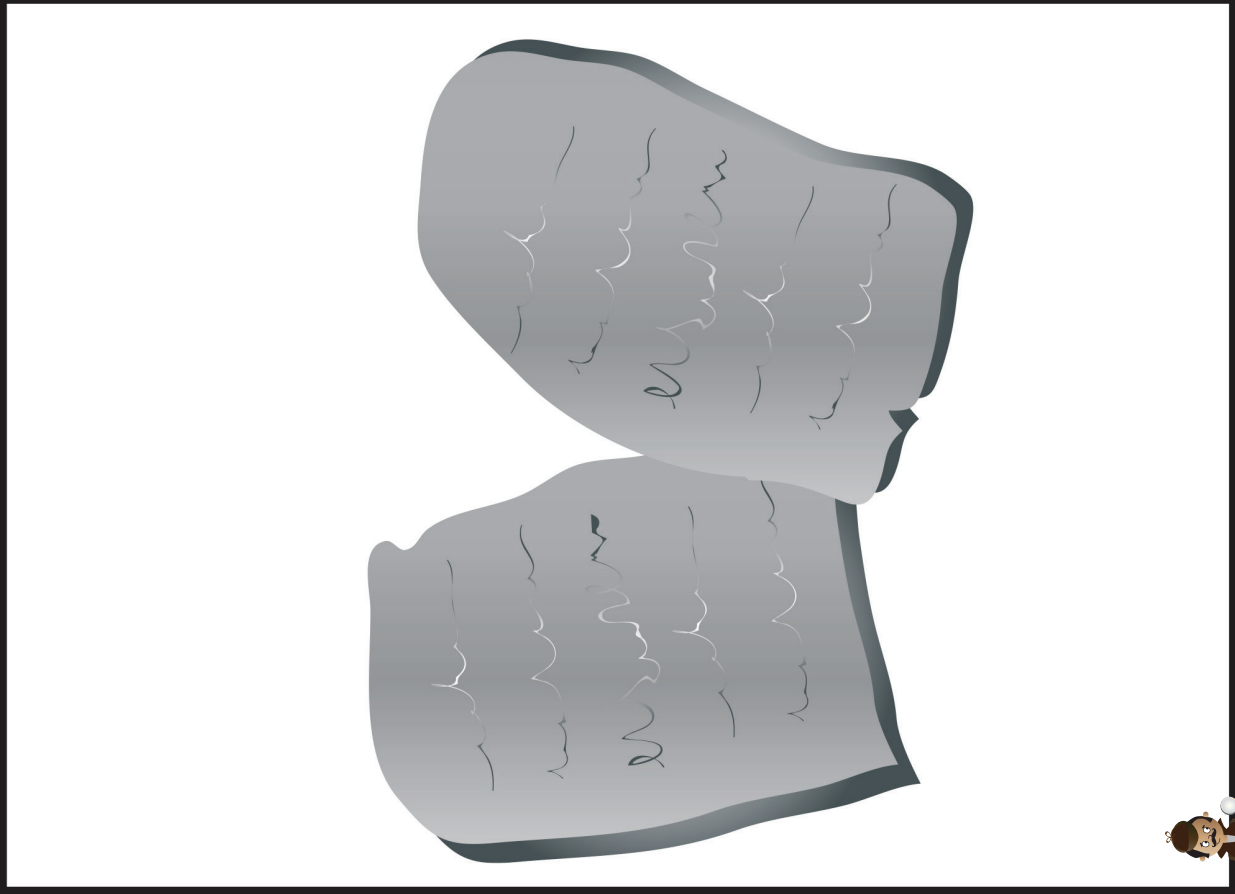

Laws Written in Stone



A Mountain called Sinai

VISUAL
AID
#5C

Place in
DDD
Bible™

take out
Big
Question
Briefcase
of BQB

VISUAL
AID
#5C

Place in
DDD
Bible™

take out
Big
Question
Briefcase
of BQB

DDD 7.1 Lesson 3 Listening Assignment Clue Picture 2 for kids

DDD 7.1 Lesson 3 Listening Assignment Clue Picture 1 for kids

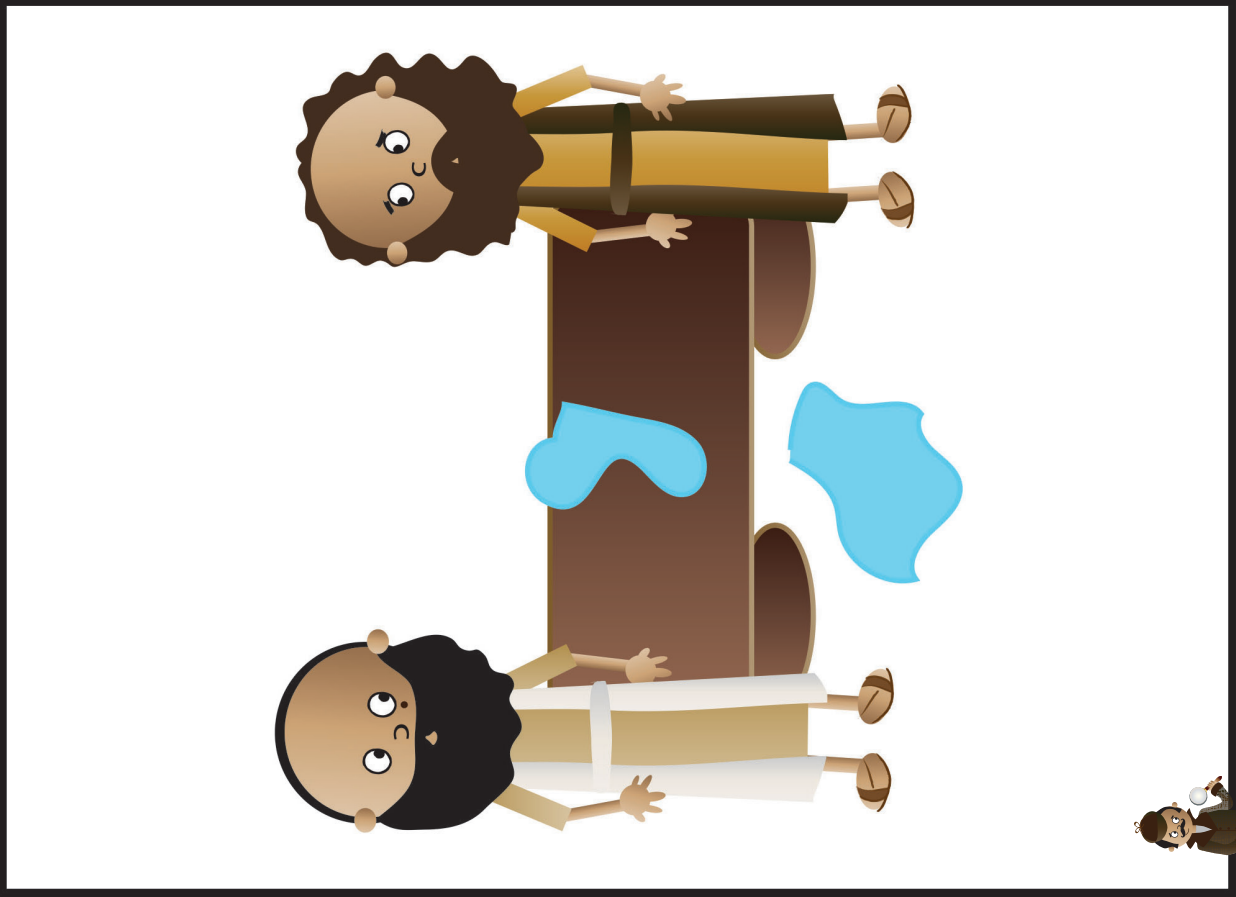

Clean Clothes

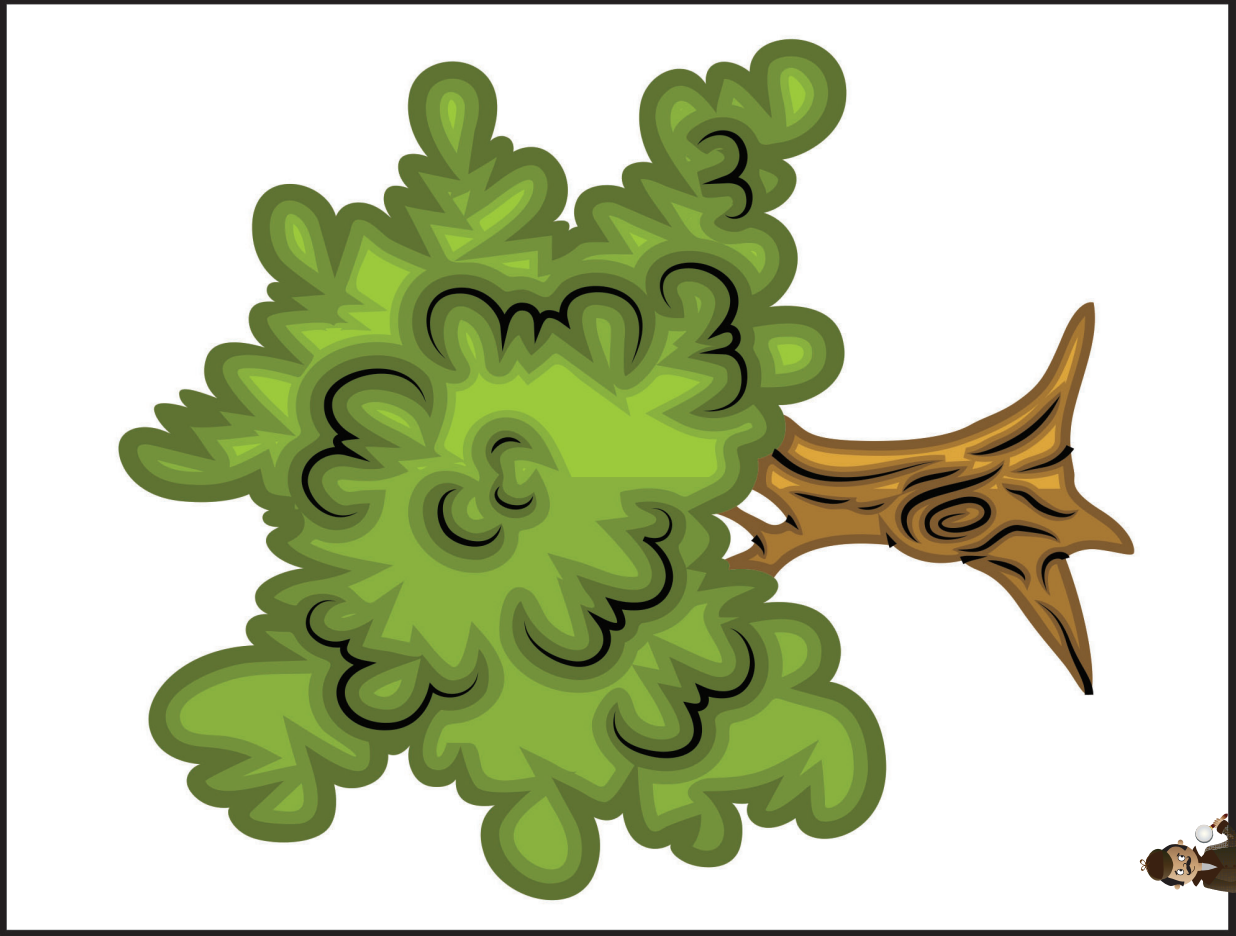

A Tree

VISUAL
AID
#5C

Place in
DDD
Bible™

take out
Big
Question
Briefcase
of BQB

VISUAL
AID
#5C

Place in
DDD
Bible™

take out
Big
Question
Briefcase
of BQB

DDD 7.1 Lesson 3 Listening Assignment Clue Picture 4 for kids

DDD 7.1 Lesson 3 Listening Assignment Clue Picture 3 for kids

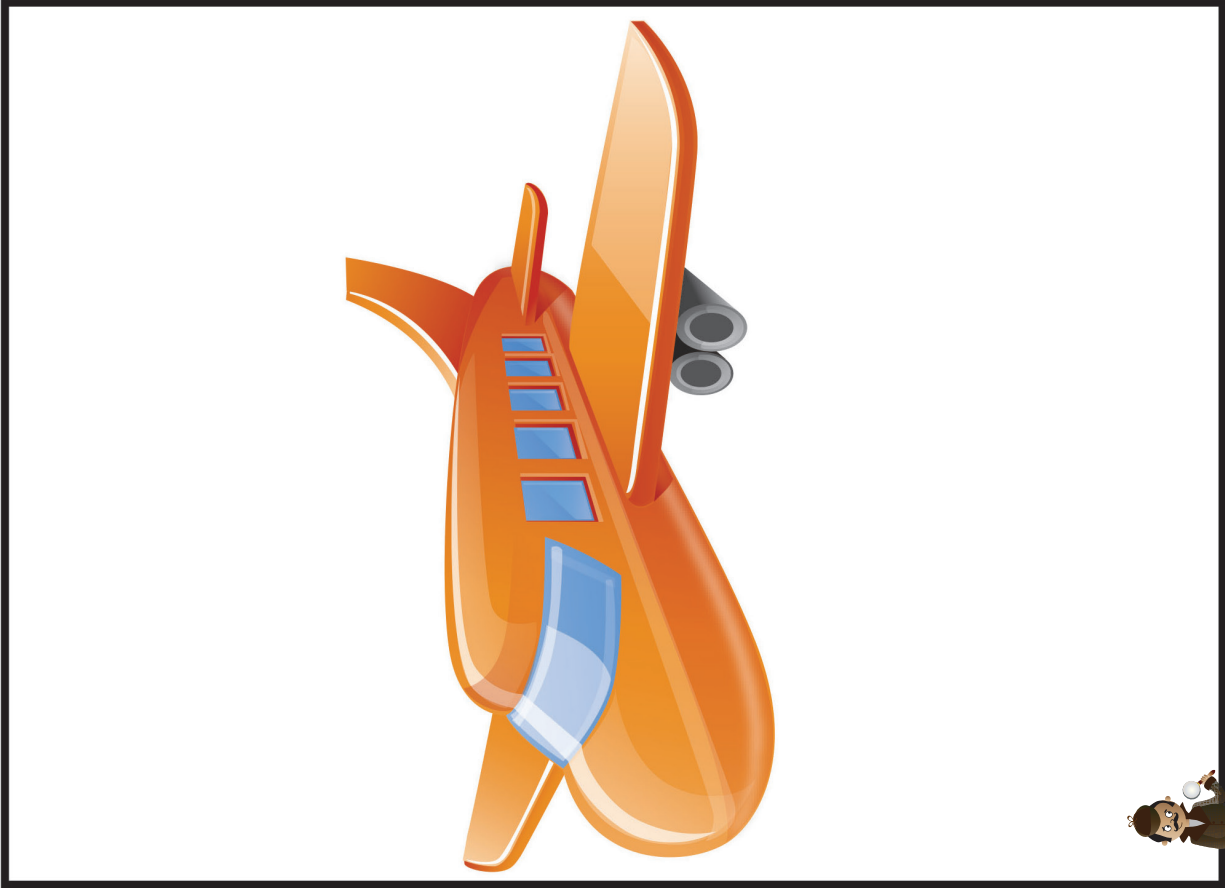

An Airplane

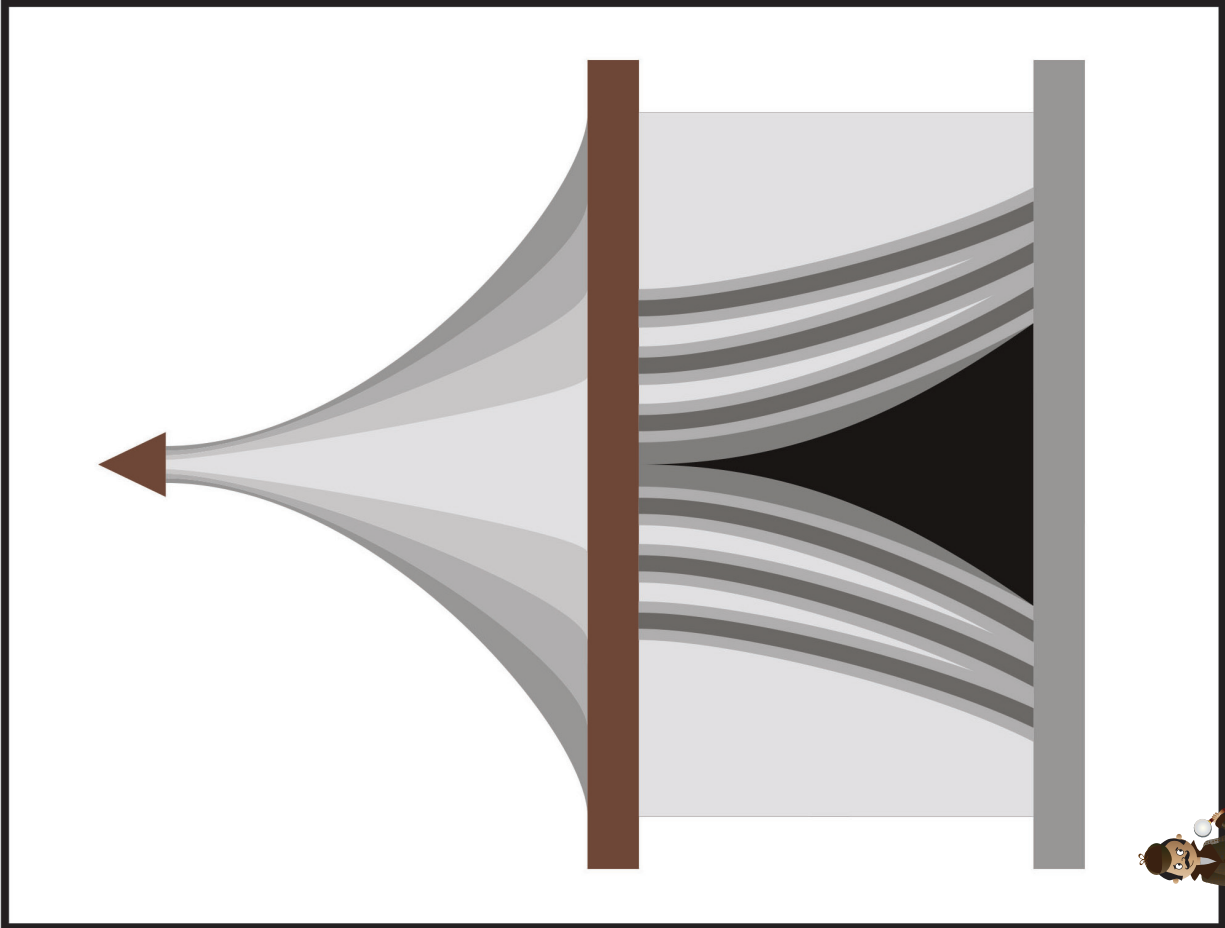

A Tent



VISUAL
AID
#5C

Place in
DDD
Bible™

take out
Big
Question
Briefcase
of BQB

VISUAL
AID
#5C

Place in
DDD
Bible™

take out
Big
Question
Briefcase
of BQB

DDD 7.1 Lesson 3 Listening Assignment Clue Picture 6 for kids

DDD 7.1 Lesson 3 Listening Assignment Clue Picture 5 for kids

“The Case of the Big Ten” Deuteronomy 5:1,7-21



Detective Dan's Listening Assignment #1

1. What were the “Big Ten”? What made them so big?
2. To whom did God give the “Big Ten” to obey?



Detective Dan's Listening Assignment #2

Deuteronomy 5:1, ESV

“Hear the rules... learn them and be careful to do them.”

1. How did God tell the people of Israel these Ten, Big Rules?
2. Why did the people need to know these rules?

(more listening and discussion questions are included in the curriculum at praisefactory.org)

I. “praise the LORD! He is the great, one, true God,” the Israelites shouted. They had so much to celebrate! God had freed us from their enemies, the Egyptians. He was taking them to a new home, a very special place called the Promised Land. Moses would lead them there.

How happy the Israelites were! Life would be good in God’s Promised Land.

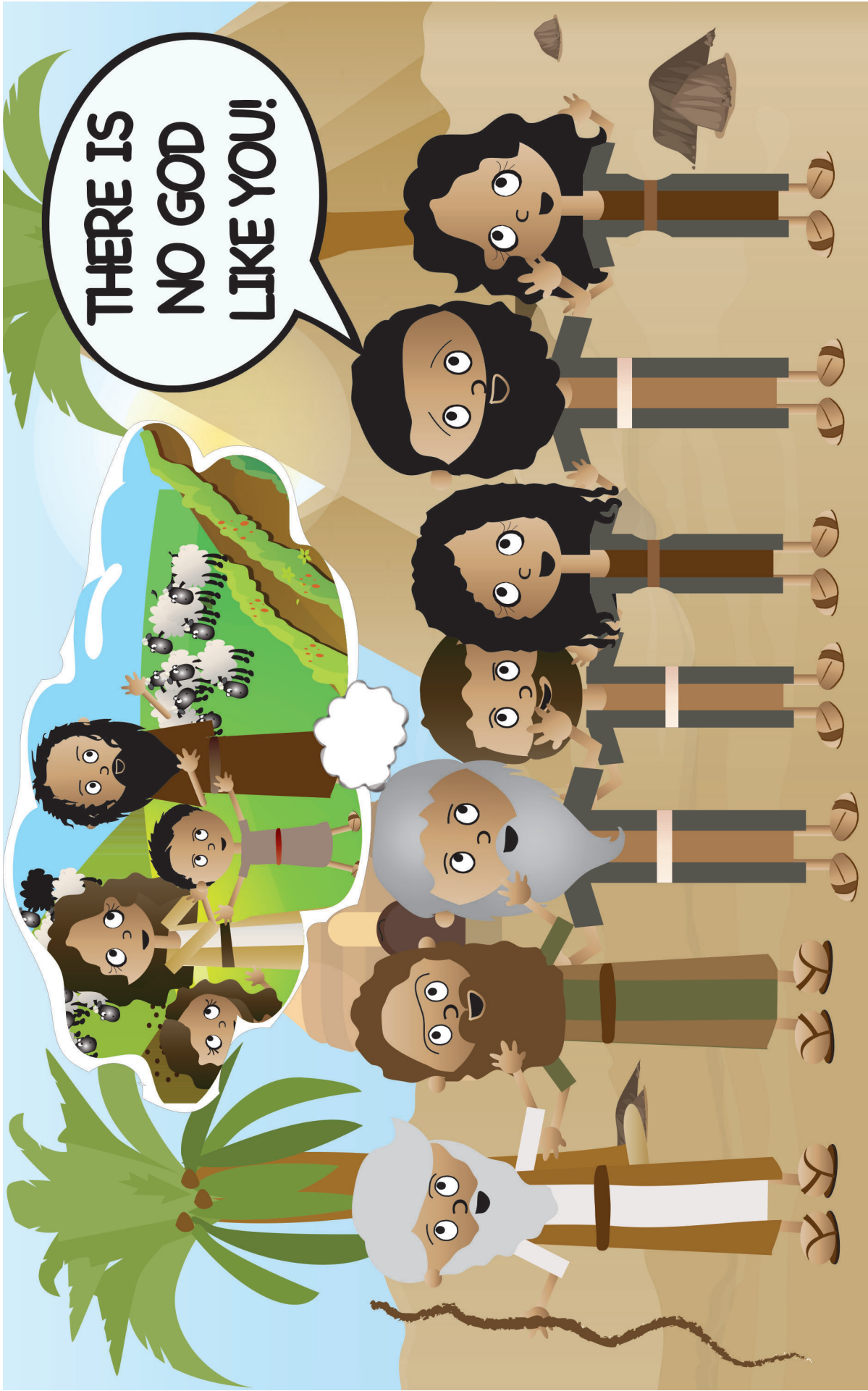

I. "Praise the LORD! He is the great, one, true God," the Israelites shouted. They had so much to celebrate! God had freed us from their enemies, the Egyptians. He was taking them to a new home, a very special place called the Promised Land. Moses would lead them there. How happy the Israelites were! Life would be good in God's Promised Land.

2. But before they could go to their beautiful, new home, the people of Israel had to go somewhere else first. They had to great Mt. Sinai, out in the hot, dry desert. It was there, the LORD would meet with them and they would make promises to each other.

The LORD would promise to always take care of them and give them everything they needed. The people would promise to love and obey Him. This is how they would become God's people.

This is how they could live happily with the LORD and each other in the Promised Land. First, must come the promises; then, the Promised Land.

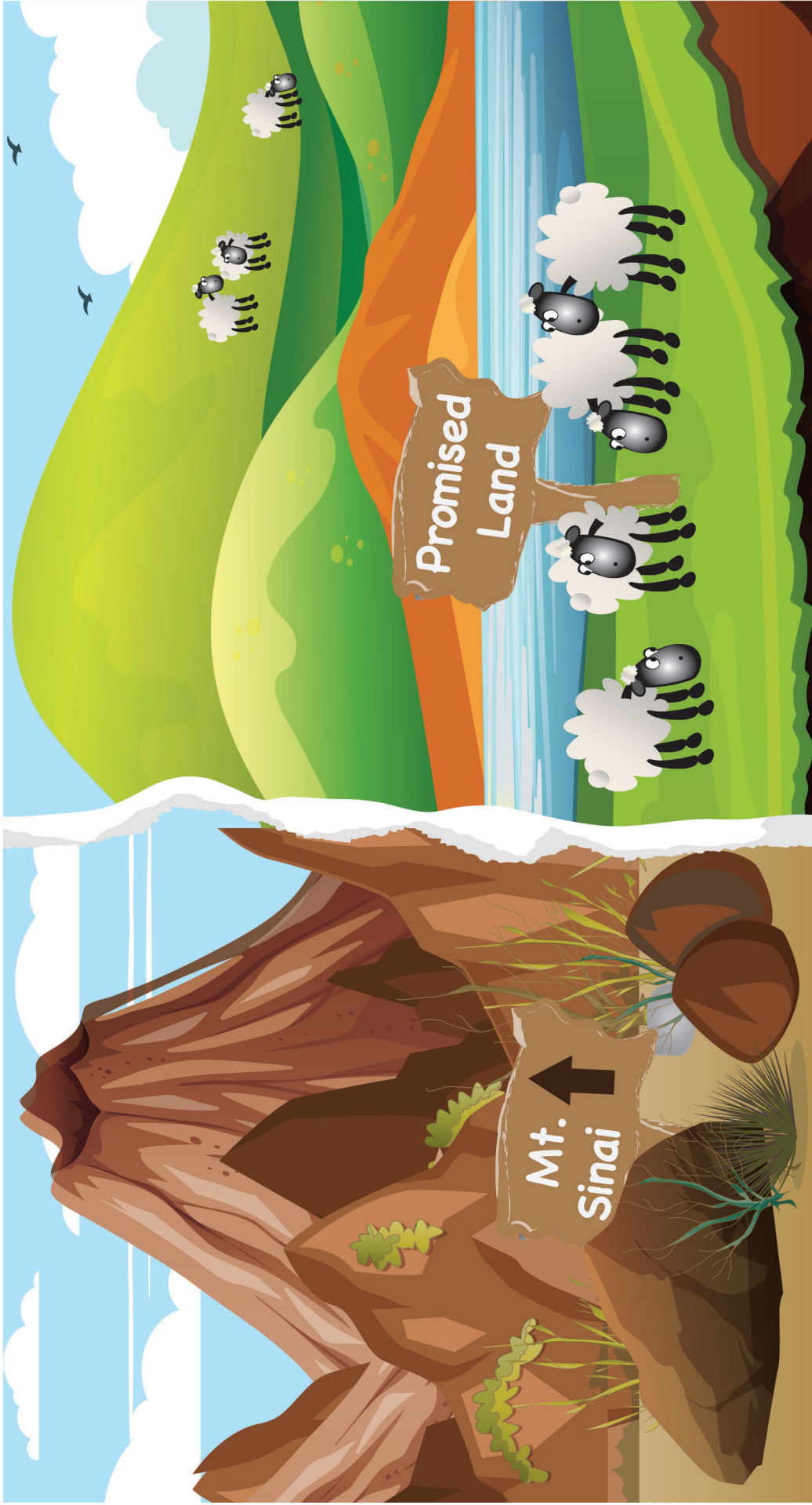

2. But before they could go to their beautiful, new home, the people of Israel had to go somewhere else first. They had to great Mt. Sinai, out in the hot, dry desert. It was there, the LORD would meet with them and they would make promises to each other. The LORD would promise to always take care of them and give them everything they needed. The people would promise to love and obey Him. This is how they would become God's people. This is how they could live happily with the LORD and each other in the Promised Land. First, must come the promises; then, the Promised Land.

3. So, tramp, tramp, tramp, they went, across the dry, dusty wilderness. How very hot the sun was, as it beat down on them! There was hardly a cloud in the sky, or a tree on the ground, to give them any shade.



3. So, tramp, tramp, tramp, they went, across the dry, dusty wilderness. How very hot the sun was, as it beat down on them! There was hardly a cloud in the sky, or a tree on the ground, to give them any shade.

4. Day after day they traveled. At last, they reached Mt. Sinai, the very mountain where Moses had first met with the LORD. And in the shadow of that mountain, they set up their camp. As they worked, Moses headed to the mountain.

What was he going to do? Moses was climbing up to meet with the LORD.



4. Day after day they traveled. At last, they reached Mt. Sinai, the very mountain where Moses had first met with the LORD. And in the shadow of that mountain, they set up their camp. As they worked, Moses headed to the mountain. What was he going to do? Moses was climbing up to meet with the LORD.

5. "It's time to get the people ready to meet Me," the LORD told Moses. "I am holy, and the people are not. I can only meet with them if they are very, very careful."

"Tell them to set up fences around the bottom of this mountain, so that no animal or person will step foot on it. Have everyone take a bath and wash their clothes. Tell them to prepare their hearts for My coming," the LORD told Moses. "And tell them to do this in the next two days. On the third day, I will come to them."

THE LORD



5. "It's time to get the people ready to meet Me," the LORD told Moses. "I am holy, and the people are not. I can only meet with them if they are very, very careful. Tell them to set up fences around the bottom of this mountain, so that no animal or person will step foot on it. Have everyone take a bath and wash their clothes. Tell them to prepare their hearts for My coming," the LORD told Moses. "And tell them to do this in the next two days. On the third day, I will come to them."

6. Moses went down and told the people all the LORD had said.

There was so much to do in two days! All the stone fence had to be put in place. All those people needed to take baths and wash their clothes. All those hearts must be made ready for the LORD.

Day One passed, then Day Two. Everything was completed. How exciting it must have been as everyone went to bed that second night! The LORD would meet with them the very next day. What would it be like?



6. Moses went down and told the people all the LORD had said. There was so much to do in two days! All the stone fence had to be put in place. All those people needed to take baths and wash their clothes. All those hearts must be made ready for the LORD. Day One passed, then Day Two. Everything was completed. How exciting it must have been as everyone went to bed that second night! The LORD would meet with them the very next day. What would it be like?

7. The next morning, they found out. Sinai was usually a land of bright sunshine and cloudless days, but not this day. The people awoke to the sound of loud rumbles of thunder and a blaring trumpet blast. They peered out of their tents to find Mt. Sinai covered in thick clouds with great flashes of lightning. Everyone trembled with fear.



7. The next morning, they found out. Sinai was usually a land of bright sunshine and cloudless days, but not this day. The people awoke to the sound of loud rumbles of thunder and a blaring trumpet blast. They peered out of their tents to find Mt. Sinai covered in thick clouds with great flashes of lightning. Everyone trembled with fear.

8. Moses led the people out of the camp to the very foot of Mt. Sinai.

They watched great, billowing clouds of smoke rise from it as the LORD descended on the top of the mountain in fire. They could feel the ground under their feet move as the whole mountain shook.

The LORD, the one, true God, had come to meet with them! Moses went up the mountain to talk with the LORD.



8. Moses led the people out of the camp to the very foot of Mt. Sinai. They watched great, billowing clouds of smoke rise from it as the LORD descended on the top of the mountain in fire. They could feel the ground under their feet move as the whole mountain shook. The LORD, the one, true God, had come to meet with them! Moses went up the mountain to talk with the LORD.

9. The trumpet blasted louder and louder, as the LORD and Moses spoke together on the mountain. Then, after making sure the people stayed off the mountain one last time, the LORD spoke in a loud voice for all the people to hear.

This is what He said to them: "I am the LORD your God who rescued you from your enemies, the Egyptians. I want to make special promises to you. I will love you and take care of you. You will be My people. But you must make special promises to Me, too. You must keep My laws, if you are to be My people." Here are My Ten Commandments:"



9. The trumpet blasted louder and louder, as the LORD and Moses spoke together on the mountain. Then, after making sure the people stayed off the mountain one last time, the LORD spoke in a loud voice for all the people to hear. This is what He said to them: "I am the LORD your God who rescued you from your enemies, the Egyptians. I want to make special promises to you. I will love you and take care of you. You will be My people. But you must make special promises to Me, too. You must keep My laws, if you are to be My people." Here are My Ten Commandments:

10. “Worship Me alone. Don’t make gods out of anything you see, in the sky or on the earth around you. Worship Me alone. I am the LORD. Honor My name. Don’t misuse it. Keep one day a week (the Sabbath day) a day of worship and rest,” the LORD told them.



1. Love Me most of all.



**3. Love Me by how you talk
about Me and how you live.**

10. "Worship Me alone. Don't make gods out of anything you see, in the sky or on the earth around you. Worship Me alone. I am the LORD. Honor My name. Don't misuse it. Keep one day a week (the Sabbath day) a day of worship and rest," the LORD told them.



**2. Don't worship fake gods.
Worship only Me.**



**4. Keep a special day to
rest and to worship Me.**

II. “Honor your father and mother. Listen to them and obey them. Don’t murder anyone. Don’t treat someone else’s husband or wife as if they are yours. Don’t steal and don’t lie. Don’t covet. Don’t keep longing after something someone else has that you want. Be happy with what I give you.”



5. Love and obey your mother and father.



6. Don't murder people.



7. Keep your promise to love only your husband/wife.



8. Don't take other people's things.

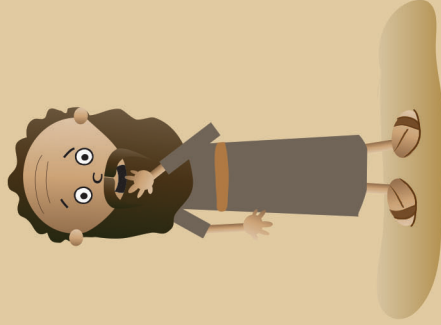

9. Don't lie.



10. Don't be greedy for what others have.

II. "Honor your father and mother. Listen to them and obey them. Don't murder anyone. Don't treat someone else's husband or wife as if they are yours. Don't steal and don't lie. Don't covet. Don't keep longing after something someone else has that you want. Be happy with what I give you."

12. The people trembled with fear when they saw the crashing lightning and the fiery mountain, and heard the crashing thunder, the loud, heavenly trumpet, and the voice of God.

They stayed away from the mountain, and said to Moses, “Speak to us, yourself, and we will listen. We will do whatever the LORD wants us to do. We want to be His people. But don’t have Him speak to us. We’re so scared by His mightiness and holiness. We’re afraid we will die,” they exclaimed.



12. The people trembled with fear when they saw the crashing lightning and the fiery mountain, and heard the crashing thunder, the loud, heavenly trumpet, and the voice of God. They stayed away from the mountain, and said to Moses, "Speak to us, yourself, and we will listen. We will do whatever the LORD wants us to do. We want to be His people. But don't have Him speak to us. We're so scared by His mightiness and holiness. We're afraid we will die," they exclaimed.

13. “Don’t be afraid,” Moses told them. “The LORD hasn’t come to hurt you. He has come in this mighty way to show you what He’s like and to help you keep His good laws. You are making promises to the great, one true God to be His people. This is a big deal. He is warning you not to break your promises to Him,” Moses said.

“But because you are afraid, I will go and meet with God for you on the mountain, then I will come back down and tell you what He says.”



13. "Don't be afraid," Moses told them. "The LORD hasn't come to hurt you. He has come in this mighty way to show you what He's like and to help you keep His good laws. You are making promises to the great, one true God to be His people. This is a big deal. He is warning you not to break your promises to Him," Moses said. "But because you are afraid, I will go and meet with God for you on the mountain, then I will come back down and tell you what He says."

14. Away went Moses. The people watched as again he climbed up Mt. Sinai and disappeared in the thick, dark cloud to meet with the LORD.

Up on the mountain, the LORD, Himself, wrote His 10 Big, Laws into pieces of stone and gave them to Moses. Then, the LORD told Moses many other laws to teach the people, so they could know how to love Him and love each other.

“Write down all these laws, so the people will always know how to love and obey Me,” the LORD said.



14. Away went Moses. The people watched as again he climbed up Mt. Sinai and disappeared in the thick, dark cloud to meet with the LORD. Up on the mountain, the LORD, Himself, wrote His 10 Big, Laws into pieces of stone and gave them to Moses. Then, the LORD told Moses many other laws to teach the people, so they could know how to love Him and love each other. "Write down all these laws, so the people will always know how to love and obey Me," the LORD said.

15. And that was what Moses did. He wrote down all of those good laws in the Bible, so that not just those Israelites, long ago, could know them; but, so all peoples, in all times, could know God's laws and how God's people should live. Even you and me!



15. And that was what Moses did. He wrote down all of those good laws in the Bible, so that not just those Israelites, long ago, could know them; but, so all peoples, in all times, could know God's laws and how God's people should live. Even you and me!

16. And, so that by those laws, we could get ready for the Savior.

How? By showing us that none of us live as God requires. We need a Savior, if we are to be God's people. It's the only way.

It's



16. And, so that by those laws, we could get ready for the Savior. How? By showing us that none of us live as God requires. We need a Savior, if we are to be God's people. It's the only way.

17. That Savior was Jesus, God's very own Son!

Jesus came and lived a perfect life. Only He obeyed all of God's laws. He gave His life as the full payment for the sins of all who turn away from their sin and trust in Him as their Savior. He died on the cross for them and rose from the dead in victory!

Through Jesus, we can become God's people. Ask Him to help you!



17. That Savior was Jesus, God's very own Son! Jesus came and lived a perfect life. Only He obeyed all of God's laws. He gave His life as the full payment for the sins of all who turn away from their sin and trust in Him as their Savior. He died on the cross for them and rose from the dead in victory! Through Jesus, we can become God's people. Ask Him to help you!

DDD 7.1 Simple Story Scenes

"The Case of the Big Ten" Deuteronomy 5:1,7-21



Detective Dan's Listening Assignment #1

1. What were the "Big Ten"? What made them so big? The "Big Ten" were the Ten Commandments that the LORD gave the people of Israel at Mt. Sinai that day. We call them BIG because they are so important. They are the laws behind all of the other laws the LORD would give. They tell us how to love the LORD and love each other.
 2. To whom did God give the "Big Ten" to obey? The LORD first gave them to the people of Israel, but they are laws for all of us to obey.
- For You and Me:**
The LORD wants all of us to obey His good laws. They are for us all to live by. But sadly, we all break them. That's why God sent Jesus to save us. He, alone, kept God's laws perfectly. Jesus gave His life as the full payment for the sins of God's people when He suffered and died on the cross. On the third day, Jesus rose from the dead in victory. He had beaten sin and death for God's people. How can we become God's people? By turning away from our sins and trusting in Jesus as our Savior. Ask Him to help you! He delights to do this!

SOLVED



Detective Dan's Listening Assignment #2

Deuteronomy 5:1, ESV

"Hear the rules... learn them and be careful to do them."

1. How did God tell the people of Israel these Ten, Big Rules? He met with them at Mt. Sinai. He spoke to them, Himself, out of a dark, thick cloud from the mountain. He, Himself, wrote them down on stone tablets for them to have.
 2. Why did the people need to know these rules? They needed to know them, so they could obey them. This was part of making special promises with God to become His people.
- For You and Me:**
All of us need to know God's Ten Commandments. God wants us to keep them if we are to be His people. But the sad truth is that none of us can ever keep God's laws as He wants us to. That's why we need a Savior if we are to be God's people. That Savior is Jesus. Jesus, God's Son, lived a perfect life. He always kept all of God's laws. Jesus gave His life as the full payment for the sins of God's people when He suffered and died on the cross. On the third day, Jesus rose from the dead in victory. He had beaten sin and death for God's people. How can we become God's people? By turning away from our sins and trusting in Jesus as our Savior. Ask Him to help you! He delights to do this!

DDD 7.1 Simple Story Scenes

What Are God's Laws Like?
God's Laws Are Perfect...

they are written in the Bible, God's Word!

God gave us His laws, so we could know how to live lives that please Him. We can read them in the Bible. But even though we know God's laws, we all disobey them. That's why we all deserve God's punishment for our sins. How sad!

But God is so rich in mercy. He sent His Son, Jesus, to live a perfect life. Yes, Jesus kept every, single one of God's laws! Jesus offered up His perfect life to God as the full payment for the sins of God's people, when He suffered and died on the cross. Then on Day Three, Jesus rose from the dead in victory. Jesus had beaten sin and death for God's people!

We can be God's people, too, when we turn away from our sins and trust in Jesus as our Savior. He loves to help us do this. Ask Him!

The Gospel



DDD 7.1 Simple Story Scenes

A Prayer

A We praise You, God, for being the Giver of Your perfectly good laws.

C God, we confess that we break Your good laws. Sometimes, we do not obey our parents. Sometimes, we lie. Sometimes, we want things that belong to others. You made us to be law keepers, but we are all lawbreakers. We need a Savior!

T Thank You for giving us Your good laws, so we know how to love and obey You. Thank You for making sure they were written down just right in Your Word, the Bible. Thank You for sending Jesus to keep Your laws perfectly and make the way for people like us to be forgiven.

S God, work in our hearts. Help us to turn away from our sins and trust in Jesus as our Savior. Help us to learn Your good laws and obey them. Help us to love You by living for You and keeping Your good laws.

In Jesus' name we pray. Amen.



DDD 7.1 Simple Story Scenes

DEEP DOWN DETECTIVES



Visual Aids

Unit 7,

Bible Truth 2

About the Deep Down Detectives Visual Aids

How Are They Used?



The Deep Down Detectives Visual Aids book is a companion resource to be used alongside the Deep Down Detectives Core Curriculum book for each unit. These colorful pictures are used in presenting the key concepts; telling the Bible stories; and, in playing the Bible Story Review games.

What Do They Include?



There are four different resources included in this book:

1. Key Concept Visual Aids-- colorful signs of the Big Question and Answer, the Bible Truth, the Bible verse, and the Listening Assignments to use with the 3 lessons for each Bible Truth.

2. The Story Scenes Placement Page--where to place the pictures on your storyboard.

3. The Story Scenes, themselves. Notice that each scene is numbered and that there is a brief summary of the story that corresponds to the picture. You can actually just tell the story in a simple way by using only the text at the bottom of each Story Scene.

5. Directions for making the Deep Down Detectives "Bible" Folder and the **back/front images** to paste in place when making it. (Larger back/front images are found online with the curriculum.)

Directions for how to make a homemade flannelgraph storyboard and sturdy Story Scene pictures are found in the back of this book.

Ready, Set, Rip It Out!

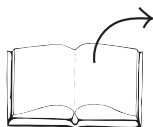

This book is meant to be ripped up and made into your visual aids. The key concept signs can be cut out and laminated or slipped into sheet protectors. The Story Scenes can be put in sheet protectors or laminated, too.

Store It!



Deep Down Detectives is a curriculum that can be used over and over. Store your visual aids and storyboard pictures after using them and they will serve you for many years. We store ours in manilla envelopes and then put them (along with all the rest of the curriculum) in magazine files, labelled by Bible Truth. If you have multiple classes using the curriculum, store each set of resources in separate manilla envelopes. This will make prep much simpler, second time around.

Replacement Story Scene Pictures



You can always purchase this book again or simply go online and print out any scenes that go missing.

Other Options



You can also choose to tell the story in a more traditional flannelgraph way by using your own flannelgraph figures or by purchasing/free downloading the Storyboard Pictures (large and small format size available). This is more complex and requires more preparation, but some love it. And, it does allow for kids to interact more by helping to place pictures up on the board as you tell the story.

Unit 7: The Law-Giving God

Unit Big Question (and Answer): What Are God's Laws Like? God's Laws Are Perfect!

Unit Bible Verse: "The law of the LORD is perfect." Psalm 19:7

Bible Truth 2 Concept: God's Laws Are Perfect... They Show Us that We Need God to Save Us!

God made us and He is in charge of us. He expects us to obey His laws all the time. But sadly, we do not. We all are sinners with sinful, selfish hearts. We disobey God's laws. We deserve His punishment for our sins. How we have rebelled against Him and His good ways!

But God is so kind and merciful! He wants to treat us better than we deserve. He sent Jesus to take the punishment for the sins of all who trust in Him as their Savior. God forgives their sins and gives them special closeness with Him in their hearts. And when they die, they will go to live with Him forever in a perfect world where there will never again be any sin. Yes! They will never again sin against Him or break His good laws. They will always love Him and others as He wants them to. How wonderful that will be! Jesus can be our Savior, too, when we turn away from our sins and trust in Him as our Savior.

Bible Truth 2 Bible Verse: Romans 3:20,21,22,23, HCSB

For no one will be justified in [God's] sight by the works of the law...But now, apart from the law, God's righteousness has been revealed... God's righteousness through faith in Jesus Christ, to all who believe...For all have sinned and fall short of the glory of God.

Learn a Little: "Apart from the law, God's righteousness has been revealed... righteousness through faith in Jesus Christ, to all who believe."

Meaning

"Righteous" is a big word that means that you are right with God. The only way we can be right with God ON OUR OWN is by obeying God's laws perfectly. But, uh oh! This Bible verse tells us that we are all sinners who break God's laws. That means we can't EVER be right with God by obeying God's laws.

But God has made a way for us to be right with Him—through His Son, Jesus. Jesus came and lived a perfect life. He kept all of God's good laws perfectly. He was righteous! And this Bible verse tells us that for all who trust in Jesus as their Savior, Jesus takes away their sins and gives His righteousness to them. That means God treats them as if they had never broken God's laws or sinned—just like Jesus! Wow! Isn't that amazing! Isn't Jesus a wonderful Savior! He can be our wonderful Savior, too, when we turn away from our sins and trust in Him as our Savior.

Bible Truth 2 ACTS Prayer

- A** We praise You, God, for being the Giver of Your perfectly good laws.
- C** God, instead of obeying Your good laws, we have all chosen to break them. Sometimes, we don't obey our parents. Sometimes, we lie. Sometimes, we want things that belong to others. We do not always love you most of all. These are only some of the ways we break Your good laws. Oh, how we need a Savior!
- T** Thank You, God, for giving us Your good laws, so we know how to love and obey You. And thank You for sending Jesus to perfectly live out Your laws and to give His life as the perfect payment for the sins of Your people. Thank You that He can be our Savior when we turn away from our sins and trust in Him.
- S** God, work in our hearts. Help us to turn away from disobeying You and trust in Jesus as our own Savior. Help us to know You and love You with the spirit You put inside us. Help us to learn Your good laws and obey them. In Jesus' name we pray, Amen.

Bible Truth 2 Story

The Case of the Rotten Innards Luke 18:9-14

Songs Used in Bible Truth 2

Big Q & A 7 Song

Big Question 7 Song: What Are God's Laws Like?

Big Question 7 Bible Verse Song: The Law of the Lord Psalm 19:7, ESV

Extra Big Question 7 Bible Verse Song: The Law of the Lord Is Perfect Psalm 19:7, ESV

Big Question 7 Hymn: Holy Bible, Book Divine

Big Question 7 Praise Song: The Best Book to Read Is the Bible

Bible Truth 2 Bible Verse Song: By Works of the Law Romans 3:20-23, HCSB

Extra Bible Truth 2 Verse Song: Now We Know Romans 3:19-24, ESV

Extra Bible Truth 2 Bible Verse Song: For Christ Suffered Once for Sins 1 Peter 3:18, ESV

Extra Bible Truth 2 Bible Verse Song: The Lord Looks Down Psalm 14:2-3, HCSB

Extra Bible Truth 2 Bible Verse Song: All We Like Sheep Isaiah 53:6, ESV

Extra Bible Truth 2 Bible Verse Song: Seek the Lord Isaiah 55:6-7, ESV

listen to or download songs for free at <https://praisefactory.org>: Deep Down Detectives Music page

The Case of the Rotten Innards

Luke 18:9-14



Story-telling Tips

Ahead of time:

1. Read the Bible verses and story. Pray!
2. Choose story action cues and/or prepare storyboard figures, if using. (Included in Visual Aids book)
3. Practice telling story with the storyboard pictures, timing your presentation. Shorten, if necessary.

During your presentation:

1. Maintain as much eye contact as possible as you tell the story.
2. Put up storyboard figures/add story action cues as you tell the story. Allow the children to help you put them on the board, if desired.
3. Include the children in your story with a few questions about what they think will happen or words/concepts that might be new to them.
4. Watch the kids for signs that their attention span has been reached. Shorten, if necessary.

INTRODUCTION/ LISTENING ASSIGNMENTS

“Our story is called: The Case of the Rotten Innards. Here is your listening assignment.” Read from Detective Dan’s Listening Assignment signs, but questions are summarized below:

Detective Dan’s Lesson #1 Listening Assignment:

“Innards” is a funny word that means a person’s insides. And in this case, it means a person’s heart, meant to love and obey God.

I need to know:

- 1. Who had a rotten heart and knew it? Who had a rotten heart and DIDN’T know it?**
- 2. What did Jesus want them all to do?**

Detective Dan’s Lesson #2 Listening Assignment:

Our Bible Verse is Romans 3:20,21,22,23, HCSB

“For no one will be justified in [God’s] sight by the works of the law...But now, apart from the law, God’s righteousness has been revealed... God’s righteousness through faith in Jesus Christ, to all who believe...For all have sinned and fall short of the glory of God.”

I need to know:

- 1. Who thought they were justified (good) in God’s sight? Why weren’t they?**
- 2. What did Jesus want these people to do?**

Detective Dan’s Lesson #3 Listening Assignment:

I found six clues, but two of them are **NOT** in the story.

They are: a drum, a Pharisee, a golden box, a sick man, the Temple, and a bag of money..

Hold each of them up for the children to see as you identify them.

I need to know:

- 1. Which four belong in the story and which two don’t?**
- 2. What did the bad, bad, bad man pray that pleased God? What did God do for this man?**

Read the assignment questions, THEN SAY,

“Ok, Deep Down Detectives! Put on your best listening ears and see if you can hear the answers to Detective Dan’s questions. When I finish telling the story, we will see if we can answer all the questions.”

Read the Bible Truth story, answer questions, present the gospel and lead in prayer.

Answers to questions; the gospel; and, ACTS prayer are included with the story text.

The Case of the Rotten Innards *Luke 18:9-14*

Story with lines separating paragraphs (text in bold, optional interaction cues in italics)

Many sick people came to see Jesus. They came with their limping legs, their blind eyes, their skin with sores, and their bleeding that wouldn't stop. Some of them were about to die. They all came to Jesus, and what do you think Jesus did?

Can you guess?

Jesus healed them with God's power! No doctor or medicine needed! "Who has ever healed sick people the way Jesus does?" they exclaimed.

People who wanted to hear about God came to Jesus, too. They crowded around Jesus, listening to everything He had to say. Jesus told them about God and His Kingdom. He told them how God wanted them to live. They listened to Jesus and were amazed at what He had to say. "Who has ever told us about God the way Jesus does?" they exclaimed.

Even people who had done very sinful things came to Jesus. Men and women who had disobeyed God's Ten Commandments in so many ways: people who had stolen money; people who had not loved their husbands or wives; people who had hurt other people; people who had worshipped other gods, and so many more. They all came to Jesus, and what do you think happened?

What do you think?

Jesus gave them God's forgiveness, when they turned away from their sins and trusted in Him. "Who has ever forgiven sins the way Jesus does?" they exclaimed.

Sick people, sinful people, people eager to learn about God, all came to Jesus, and He satisfied them. How wonderful, how amazing was Jesus!

But there was another kind of people who came to Jesus, too. These people were different from all the rest. They weren't sick. They weren't eager to learn about God from Jesus. And most of all, they didn't even think they were sinners who needed God's forgiveness. They were the important Bible teachers back in Jesus' day. They had a special name for themselves. Do you know what it was?

Can you remember?

They were called the Pharisees.

The Pharisees were smart students, and they studied hard. Not only did they learn and try to obey God's Ten Commandments, but they learned and tried to obey the hundreds of God's other laws, too. They spent day after day, week after week, year after year, learning them all by heart! Wow!

But obeying God's laws wasn't enough for the Pharisees. They wanted to be extra careful to please God, so they added a lot of extra, little rules for everyone to obey. Rules that God didn't give His people. They added extra rules about washing your hands just right. (Not to get rid of dirt or germs that might make you sick, as we do, but because they thought these specially cleaned hands were how you pleased God.) Those hand-washing rules were just the beginning of what they added to God's laws. There were rules about food to eat or not eat, about giving extra gifts to God, and about what work you could NOT do on the Sabbath Day of Rest (such as not looking in a mirror because you might be tempted to pluck out a gray hair from your head), and lots of other rules. The Pharisees tried very hard to obey all their extra, little rules. They wanted the people to obey them, too. They thought those extra, little rules helped everyone keep God's big laws better. They thought those extra rules pleased God and made them good people.

Story with lines separating paragraphs (text in bold, optional interaction cues in italics)

And most of all, the Pharisees thought God might send the Messiah, the Savior, sooner if everyone was very good, and kept all the little, bitty rules as well as God's big laws. Oh, how they wanted the Messiah to come!

But those Pharisees were wrong about so many things! They didn't realize that the Messiah, the Savior, HAD come already. He was right there, living among them, teaching them about God, and doing amazing things by God's power. Can you tell me who God's Savior was?

Can you tell me?

It was Jesus!

And the Pharisees were wrong about something else, too. Instead of becoming good, good, good people when they kept all of these extra little, bitty, rules, these Pharisees became proud, proud, proud people! "We are better than everyone else because we do such a good job obeying all these extra, little, bitty rules," many of them thought. "We're so good that we don't need God's forgiveness, as other people do. God is pleased with us just the way we are!" they believed.

Do you think these Pharisees were right? Did keeping all of these extra, little, bitty rules mean they didn't need God's forgiveness?

How very wrong those Pharisees were! All those extra, little, bitty rules they made up didn't please God. Why, even trying very hard to obey all of God's big laws isn't enough to please God! There is only ONE WAY to please God by obeying His laws. Do you know what it is?

It is being PERFECT. That right! It's obeying God's laws ALL THE TIME! Never disobeying ...EVER! Never saying anything wrong or doing anything wrong. Never thinking anything wrong or BEING anything wrong. Do you think that sounds like something those Pharisees could do?

What do you think?

No, the Pharisees could not be this good. They had "rotten innards" --sinful hearts-- just like everyone else. They would never be able to please God by trying to be good.

And guess what? Neither can we. Why? Because every one of us has a sinful heart, too. Every one of us has broken God's laws. We all need God's forgiveness for our sins. That is the only way we can know and please God. That's the only way we can live with God as His people.

But these poor, proud Pharisees would just not see this. They were SURE that they were already good enough to please God, and they were SURE that all those other people who came to Jesus were not. So, what did Jesus do with these proud men who thought they were so good?

What do you think He did?

Jesus loved them, that's what He did. Jesus wanted to help them, just like He wanted to help everyone else who came to Him. So, Jesus told them a story to help them see that they needed God to save them and forgive them, just like everyone else did. Maybe then they would understand that they were sinners and would ask God for forgiveness.

Story with lines separating paragraphs (text in bold, optional interaction cues in italics)

And this is the story Jesus told them:

“One day, two men went to God’s Temple (the worship place) to pray. One man was a Pharisee. The other man was a tax collector;” Jesus said.

“The Pharisee thought of himself as a very good man who pleased God by obeying God’s laws and the teachers’ extra rules. So, he stretched his arms up high and looked up to heaven and proudly prayed, “God, thank You that I am different from other men, like that tax collector over there. I don’t do the bad things they do. I am good, good, good. I keep all your laws and all the extra rules of my teachers, too;” he prayed.

Can you believe that? That Pharisee didn’t praise GOD for being good! He only boasted to God about his OWN goodness! That Pharisee wasn’t really a good, good, good man at all, was he? No! He was really a proud, proud, proud man!

Then, Jesus went on with his story. He told about the other man. “The tax collector came to the Temple knowing he was a bad, bad, bad man. He knew he had “rotten innards” --a sinful heart. He knew the sin in his heart showed in how he lived. He had chosen to disobey God’s good laws. He had chosen to become rich by taking too much money from people.

And when this tax collector prayed to God, it wasn’t boldly and proudly like the Pharisee. No, this man KNEW he had done lots of bad things and he was sad about them. He was sad he had disobeyed God’s laws and treated others so badly. He KNEW he wasn’t right with God; and oh, how he wanted to be!

The tax collector was too ashamed of his sins to stretch up his arms or look up to heaven to pray. He looked down at his feet, beat his chest, and cried out to God, “God, have mercy on me! I am so bad. I have disobeyed Your laws. I have a sinful heart. Have mercy on me! Please, forgive my sins!”

Then Jesus told the Pharisees listening to Him: “The Pharisee went home feeling proud. He was so sure that his life pleased God, but he was wrong. God is not pleased with proud people who don’t see that they are sinners who need His forgiveness;” Jesus told them.

“But that tax collector, who knew he was a sinner, went home forgiven by God;” Jesus said. “God loves to forgive sinners --even very bad sinners-- who confess their sins to Him and humbly ask for His forgiveness;” Jesus told them.

What did the Pharisees think of Jesus’ story? Did they learn from it? Did they see that everyone has broken God’s laws, even people, like themselves, who tried really hard to be good? Did they, at last, see that no one can ever do enough good things to be proud before God? Did they see their own sins and ask God to forgive them?

What do you think?

The Bible doesn’t tell us what happened with those Pharisees that day. But, we DO know that later, some of these very important teachers --like Joseph of Arimathea and Nicodemus-- DID turn away from their sins and asked God to forgive them. They put their trust in Jesus as their Savior. And did you know that these two men were the very ones who put Jesus’ body in the cave-grave, after He had suffered and died on the cross?

How amazed and happy they both must have been when Jesus rose from the dead on the third day! Jesus really was the Messiah, the Savior, God had sent to save His people and forgive their sins! He had beaten sin and death for all who turn away from their sins and trust in Him as their Savior.

Cracking the Case: (story wrap-up for Listening Assignments)

It's time to see how we did with our Listening Assignment.

Detective Dan's Lesson #1 Listening Assignment:

"Innards" is a funny word that means a person's insides. And in this case, it means a person's heart, meant to love and obey God.

I need to know:

1. Who had a rotten heart and knew it? Who had a rotten heart and DIDN'T know it? Many of the people who came to see Jesus knew they had disobeyed God's laws and were sinners. They knew they needed God's forgiveness. The Pharisees were also sinners with "rotten hearts," but they didn't know it. They thought they pleased God with all the laws they kept and all the good things they thought they did.

2. What did Jesus want them all to do? Jesus wanted everyone to turn away from their sins, ask God for forgiveness, and trust in Him as their Savior.

For You and Me:

Just like everyone in Jesus' day, we, too, have sinful "rotten" hearts. We all break God's laws and we need His forgiveness. We can have His forgiveness when we turn away from our sins and trust in Jesus as our Savior. God will forgive our sins and make us His people. Ask God to help you! He loves to answer this prayer!

Detective Dan's Lesson #2 Listening Assignment:**Our Bible Verse is Romans 3:20,21,22,23, HCSB**

"For no one will be justified in [God's] sight by the works of the law...But now, apart from the law, God's righteousness has been revealed... God's righteousness through faith in Jesus Christ, to all who believe...For all have sinned and fall short of the glory of God."

I need to know:

1. Who thought they were justified (good) in God's sight? Why weren't they? The Pharisees thought they were justified in God's sight because they obeyed God's laws and all the extra rules. They weren't justified because no one (except Jesus) keeps God's laws perfectly---and that's the only way to be justified by obeying God's law.

2. What did Jesus want these people to do? He wanted them to understand that they were sinners who needed to turn to God and ask for His forgiveness. He wanted them to trust in Him as their Savior, so they might be saved from their sins.

For You and Me:

Just like the Pharisees, we also cannot be justified (made right with God) by doing good things and trying to obey God's laws. We will never obey them perfectly. We all break God's laws and we need His forgiveness. We can have His forgiveness when we turn away from our sins and trust in Jesus as our Savior. God will forgive our sins and make us His people. Ask God to help you! He loves to answer this prayer!

Detective Dan's Lesson #3 Listening Assignment:

I found six clues, but two of them are **NOT** in the story. They are: a drum, a Pharisee, a golden box, a sick man, the Temple, and a bag of money.

Hold each of them up for the children to see as you identify them.

I need to know:

1. Which four belong in the story and which two don't? The Pharisee, the sick man, the Temple and the bag of money belong. The drum and the golden box do not.

2. What did the bad, bad, bad man pray that pleased God? What did God do for this man? He told God that he was a sinner and asked for God to show him mercy. He knew he needed God's forgiveness. God forgave his sins.

For You and Me:

Like the tax collector, we, too, have sinned against God. We need God to forgive our sins. And God will! How? When we turn away from our sins and trust in Jesus as our Savior. God will forgive our sins and make us His people. Ask God to help you! He loves to answer this prayer!

The Gospel (story wrap-up if NOT using Listening Assignments)**Our Bible Truth is:****What Are God's Laws Like?****God's Laws Are Perfect...****They Show Us that We Need God to Save Us!**

How true that is! We learn God's good laws, but we break them! We choose to disobey God. We all deserve God's punishment for our sins! And we know that we can never deserve His forgiveness. How sad! God would have been perfectly fair to give us all the punishment we deserve for breaking His laws. He is holy and good. But God is so rich in mercy. He chose to give us something better than we deserve. He sent His Son Jesus to live a perfect life. Yes! Jesus kept every, single one of God's laws! And on the cross, He suffered and died, giving His perfect life as the full payment for the sins of all who turn away from their sins and trust in Him as their Savior. On the third day, Jesus rose from the dead. He had really beaten sin and death! Because of Jesus, all who trust in Him as their Savior get to enjoy wonderful, special closeness with God as His special people, even now. And one day, they will go to live with Him forever. We can be God's people when we turn from our sins and trust in Jesus. Ask Him to help you! He loves to do this!

Close in prayer.

Closing ACTS Prayer

- A** We praise You, God, for being the Giver of Your perfectly good laws.
- C** God, instead of obeying Your good laws, we have all chosen to break them. Sometimes, we don't obey our parents. Sometimes, we lie. Sometimes, we want things that belong to others. We do not always love you most of all. These are only some of the ways we break Your good laws. Oh, how we need a Savior!
- T** Thank You, God, for giving us Your good laws, so we know how to love and obey You. And thank You for sending Jesus to perfectly live out Your laws and to give His life as the perfect payment for the sins of Your people. Thank You that He can be our Savior when we turn away from our sins and trust in Him.
- S** God, work in our hearts. Help us to turn away from disobeying You and trust in Jesus as our own Savior. Help us to know You and love You with the spirit You put inside us. Help us to learn Your good laws and obey them. In Jesus' name we pray, Amen.

Go to Lesson Plan, p.9 for the script to the rest of the lesson.

BIG QUESTION 7



What are God's laws like?

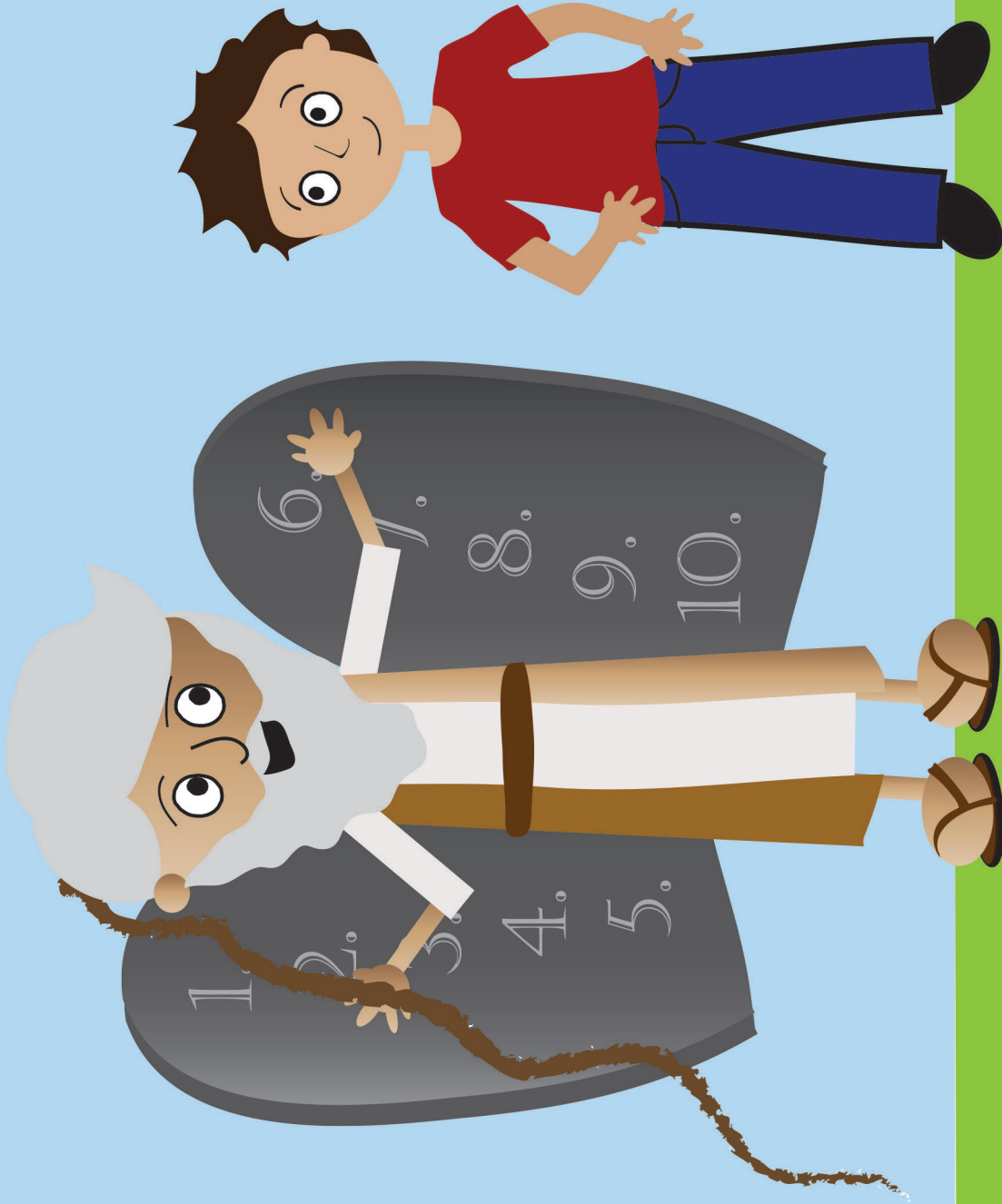

ANSWER:

God's laws are perfect!

VISUAL
AID

#1

take out



The Big Question

Hold up the Big Question sign for all the children to see, and say:

The Big Question we are investigating today is
Big Question Number 7:

What Are God's Laws Like?
and the Answer is:
God's Laws Are Perfect!

Meaning:

A law is a big rule made by someone in charge. God is our Maker. He is in charge of everyone in the whole world. He has given us His laws to live by.

God is good and loving, wise and fair. He is perfect! God's laws are just like Him. They are good and loving, wise and fair, too. They are perfect!

God's laws show us the very best way to live. They show us how to love God and love others. They are exactly what we need.

Let's sing our Big Question Song: "

Big Q & A 7 Song

*DDD ESV Songs 7, track 12
(adapted version of "The Farmer in the Dell")*

What are God's laws like?
What are God's laws like?
What are God's laws like?
God's laws are perfect!

BIG QUESTION 7: Three truths about God's laws

Visual Aid #2
take out
Big Question
Briefcase
of BQB

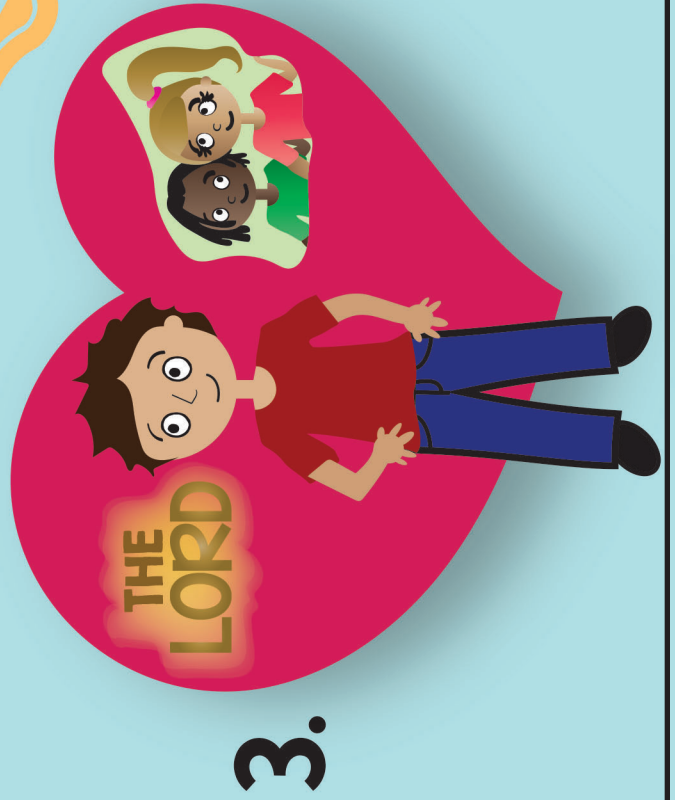
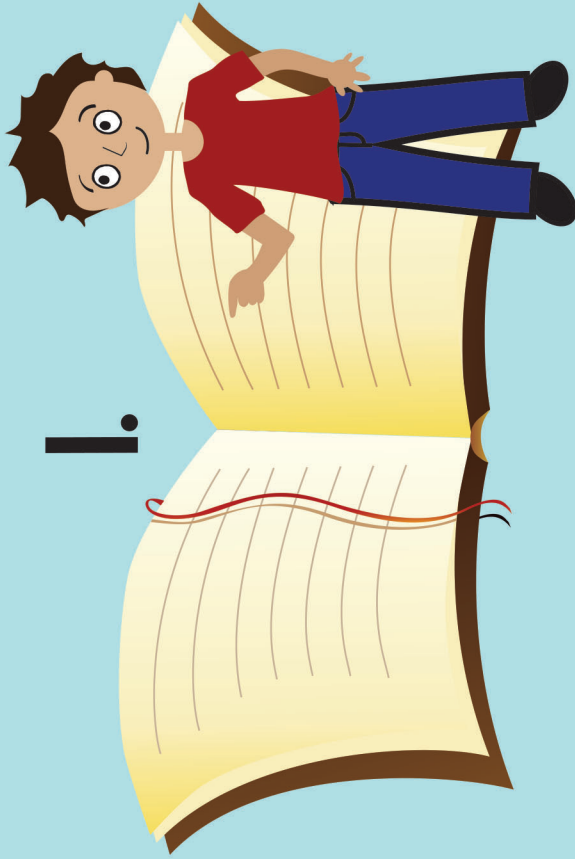

This Unit's Bible Truths

"God's laws are perfect is a good beginning, but there's so more to learn. So it's time for us to dig down even deeper for more answers to our Big Question about God. We're going to be learning THREE Bible truths that all tell us more about God's perfect laws.

Who would like to hand me the picture with our three Bible truths on it? It's in the Big Question Box/Briefcase."

Choose a child to get it and hand it to you, then hold it up and show them the pictures of the three truths they will be learning. After everyone has had a good look, say...

"Ok, we've learned one truth about God's laws. It's this one: "They Were Written in the Bible, God's Word." (point to pictures as you identify each Bible Truth). Now let's look at our Bible Truth Clue sign and see if we can figure out which of these three truths we will be learning about today. Who would like to get it out of the Big Question Briefcase for me?"

Choose a child to open the briefcase, take out the Bible Truth Clue sign and hand it to you.

CAN YOU GUESS BIBLE TRUTH 2:

**What are God's laws like?
God's laws are perfect...
they show us that we
need God to
??? us!**

**HINT: "What did Jesus do for
God's people when He died on
the cross? It starts with an "s"
and it rhymes with "brave."**

**ANSWER:
They Show Us that We Need God to SAVE Us!**

Visual
Aid
#3



of BQB

take out



Revealing the Bible Truth We Are Learning

Hold up the front side for the children to see. Cover up the answer, written along the bottom, and say:

**“What Are God’s Laws Like?
God’s Laws Are Perfect!
They Show Us that We Need God to ???? Us!”**

We’re missing one word. Here’s the hint to what the missing word is. It says: “What did Jesus do for God’s people when He died on the cross? It starts with a “s” and it rhymes with “brave.”

Can you guess? It’s “save.”

So the Bible Truth we are learning today is:

(Uncover answer from bottom of sign, show it to them and say:)

**“What Are God’s Laws Like?
God’s Laws Are Perfect!
They Show Us that We Need God to SAVE Us!”**

And here is what this Bible Truth means:
(read the meaning off of the back of the sign, say:)

God made us and He is in charge of us. He expects us to obey His laws all the time. But sadly, we do not. We all are sinners with sinful, selfish hearts. We disobey God’s laws. We deserve His punishment for our sins. How we have rebelled against Him and His good ways!

But God is so kind and merciful! He wants to treat us better than we deserve. He sent Jesus to take the punishment for the sins of all who trust in Him as their Savior. God forgives their sins and gives them special closeness with Him in their hearts. And when they die, they will go to live with Him forever in a perfect world where there will never again be any sin. Yes! They will never again sin against Him or break His good laws. They will always love Him and others as He wants them to. How wonderful that will be! Jesus can be our Savior, too, when we turn away from our sins and trust in Him as our Savior.

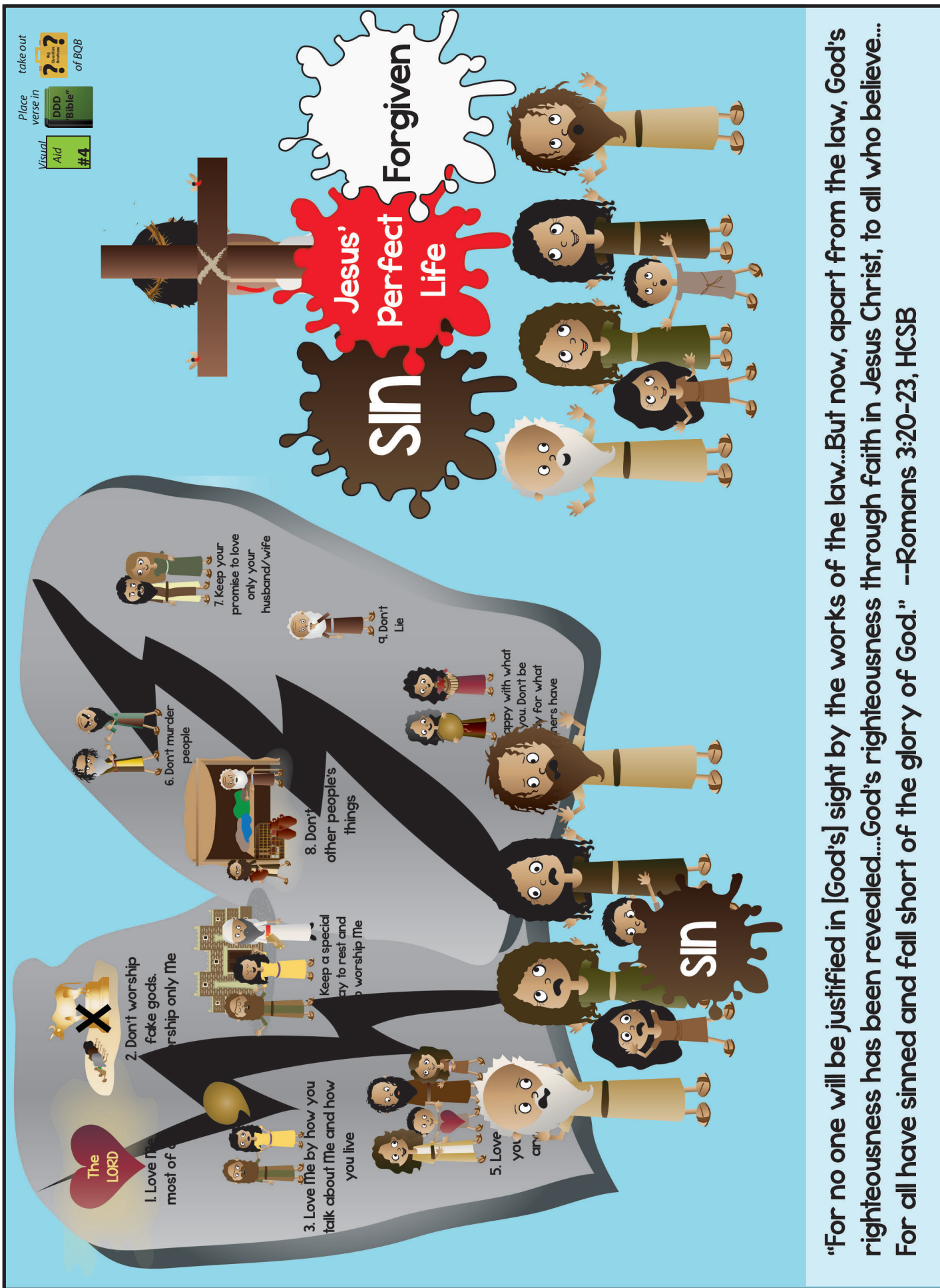

Visual Aid #4

Place verse in DDD Bible of BCB

take out ?

The LORD

1. Love Me most of your life

3. Love Me by how you talk about Me and how you live

2. Don't worship fake gods. Worship only Me

6. Don't murder people

8. Don't do other people's things

7. Keep your promise to love only your husband/wife

9. Don't Lie

10. Be happy with what you have. Don't be greedy for what others have

SIN

Jesus' Perfect Life

Forgiven

“For no one will be justified in [God’s] sight by the works of the law...But now, apart from the law, God’s righteousness has been revealed...God’s righteousness through faith in Jesus Christ, to all who believe... For all have sinned and fall short of the glory of God.” --Romans 3:20-23, HCSB

Bible Truth 2 Bible Verse

Remove the Bible Verse Picture from the "Bible" folder and hold it up for all the children to see, then say:

Romans 3:20,21,22,23 tells us:

Romans 3:20,21,22,23, HCSB

"For no one will be justified in [God's] sight by the works of the law... But now, apart from the law, God's righteousness has been revealed... God's righteousness through faith in Jesus Christ, to all who believe... For all have sinned and fall short of the glory of God."

Learn a Little: "Apart from the law, God's righteousness has been revealed... righteousness through faith in Jesus Christ, to all who believe."

What does that mean?

"Righteous" is a big word that means that you are right with God. The only way we can be right with God ON OUR OWN is by obeying God's laws perfectly. But, uh oh! This Bible verse tells us that we are all sinners who break God's laws. That means we can't EVER be right with God by obeying God's laws.

But God has made a way for us to be right with Him—through His Son, Jesus. Jesus came and lived a perfect life. He kept all of God's good laws perfectly. He was righteous! And this Bible verse tells us that for all who trust in Jesus as their Savior, Jesus takes away their sins and gives His righteousness to them. That means God treats them as if they had never broken God's laws or sinned--just like Jesus! Wow! Isn't that amazing! Isn't Jesus a wonderful Savior! He can be our wonderful Savior, too, when we turn away from our sins and trust in Him as our Savior.

"We've said our Bible verse, now let's sing it!"

By Works of the Law:

Romans 3:20-23

DDDESV Songs 7, track 21

By works of the law,
By works of the law,
No one will be justified,
By works of the law. *Why?*

For all have sinned,
Fall short of the glory of God. *Oh, no!*

But listen to what God has done:

Apart from the law,
Apart from the law,
Now God's righteousness has been revealed,
Apart from the law. *How?*

Through faith in Jesus Christ,
To all who believe. Thank you, God!
Romans Three, twenty through twenty-three.

"Now it's time to do a bit more deep down investigating. Let's see what Detective Dan wants us to help him figure out. Would someone like to get it out for me?"

take out



Place in



Visual Aid



Detective Dan's Listening Assignment #1

Detective Dan's

Listening Assignment #1



Hi, Deep Down Detectives!

I'm working on a brand-new case called:

"The Case of the Rotten Innards."

I need to find out:

"Innards" is a funny word that means a person's insides. And in this case, it means a person's heart, meant to love and obey God.

I need to know:

1. Who had a rotten heart and knew it? Who had a rotten heart and DIDN'T know it?

AND

2. What did Jesus want them all to do?

Can you help me? Listen carefully to the story and you might just hear the answers!

Thanks!

Detective Dan

Then say, "Ok, Deep Down Detectives! Put on your best listening ears and see if you can hear the answers to Detective Dan's questions. When I finish telling the story, we will see if we can answer all of his questions."

Read the Bible Truth story, putting up the storyboard pictures as you tell it.

At the end of the story, repeat the questions and lead the children in answering them. Present the gospel and close in prayer.

Answers to assignment questions, the gospel and ACTS prayer are also included at the end of the story text.

Answers:

1. Who had a rotten heart and knew it? Who had a rotten heart and DIDN'T know it? Many of the people who came to see Jesus knew they had disobeyed God's laws and were sinners. They knew they needed God's forgiveness. The Pharisees were also sinners with "rotten hearts," but they didn't know it. They thought they pleased God with all the laws they kept and all the good things they thought they did.

2. What did Jesus want them all to do? Jesus wanted everyone to turn away from their sins, ask God for forgiveness, and trust in Him as their Savior.

For You and Me:

Just like everyone in Jesus' day, we, too, have sinful "rotten" hearts. We all break God's laws and we need His forgiveness. We can have His forgiveness when we turn away from our sins and trust in Jesus as our Savior. God will forgive our sins and make us His people. Ask God to help you! He loves to answer this prayer!

take out



of BQB

Place in



Visual Aid



Detective Dan's Listening Assignment #2

Detective Dan's

Listening Assignment #2



Hi, Deep Down Detectives!

I'm still working on the case called:

"The Case of the Rotten Innards."

Our Bible verse is Romans 3:20,21,22,23, HCSB:

"For no one will be justified in [God's] sight by the works of the law...But now, apart from the law, God's righteousness has been revealed... God's righteousness through faith in Jesus Christ, to all who believe...For all have sinned and fall short of the glory of God."

I need to find out:

1. Who thought they were justified (good) in God's sight? Why weren't they?

AND

2. What did Jesus want these people to do?

Can you help me? Listen carefully to the story and you might just hear the answers!

Thanks for your help!

Detective Dan

Then say, "Ok, Deep Down Detectives! Put on your best listening ears and see if you can hear the answers to Detective Dan's questions. When I finish telling the story, we will see if we can answer all of his questions."

Read the Bible Truth story, putting up the storyboard pictures as you tell it. At the end of the story, repeat the questions and lead the children in answering them. Present the gospel and close in prayer.

Answers to assignment questions, the gospel and ACTS prayer are also included at the end of the story text.

Answers:

Our Bible Verse is: Romans 3:20,21,22,23, HCSB

"For no one will be justified in [God's] sight by the works of the law...But now, apart from the law, God's righteousness has been revealed... God's righteousness through faith in Jesus Christ, to all who believe...For all have sinned and fall short of the glory of God."

For You and Me:

1. Who thought they were justified (good) in God's sight? Why weren't they? The Pharisees thought they were justified in God's sight because they obeyed God's laws and all the extra rules. They weren't justified because no one (except Jesus) keeps God's laws perfectly----and that's the only way to be justified by obeying God's law.

2. What did Jesus want these people to do? He wanted them to understand that they were sinners who needed to turn to God and ask for His forgiveness. He wanted them to trust in Him as their Savior, so they might be saved from their sins.

For You and Me:

Just like the Pharisees, we also cannot be justified (made right with God) by doing good things and trying to obey God's laws. We will never obey them perfectly. We all break God's laws and we need His forgiveness. We can have His forgiveness when we turn away from our sins and trust in Jesus as our Savior. God will forgive our sins and make us His people. Ask God to help you! He loves to answer this prayer!

take out



Place in



Visual Aid



Detective Dan's Listening Assignment #3

Detective Dan's

Listening Assignment #3



Hi, Deep Down Detectives!

I'm still working on the case called:

"The Case of the Rotten Innards."

I found SIX clues, but TWO of them are NOT in the story. They are: a drum, a Pharisee, a golden box, a sick man, the Temple, and a bag of money.

Hold up each of the six pictures for the children to see as you identify them. Better yet, put them up on your flannelgraph board, off to one side.

I need to know:

1. Which four belong in the story and which two don't?

AND

2. What did the bad, bad, bad man pray that pleased God? What did God do for this man?

Can you help me? Listen carefully to the story and you might just hear the answers!

Thanks!

Detective Dan

Then say, "Ok, Deep Down Detectives! Put on your best listening ears and see if you can hear the answers to Detective Dan's questions. When I finish telling the story, we will see if we can answer all of his questions."

Read the Bible Truth story, putting up the storyboard pictures as you tell it. At the end of the story, repeat the questions and lead the children in answering them. Present the gospel and close in prayer.

Answers to assignment questions, the gospel and ACTS prayer are also included at the end of the story text.

Answers:

1. Which four belong in the story and which two don't? The Pharisee, the sick man, the Temple and the bag of money belong. The drum and the golden box do not.

2. What did the bad, bad, bad man pray that pleased God? What did God do for this man? He told God that he was a sinner and asked for God to show him mercy. He knew he needed God's forgiveness. God forgave his sins.

For You and Me:

Like the tax collector, we, too, have sinned against God. We need God to forgive our sins. And God will! How? When we turn away from our sins and trust in Jesus as our Savior. God will forgive our sins and make us His people. Ask God to help you! He loves to answer this prayer!

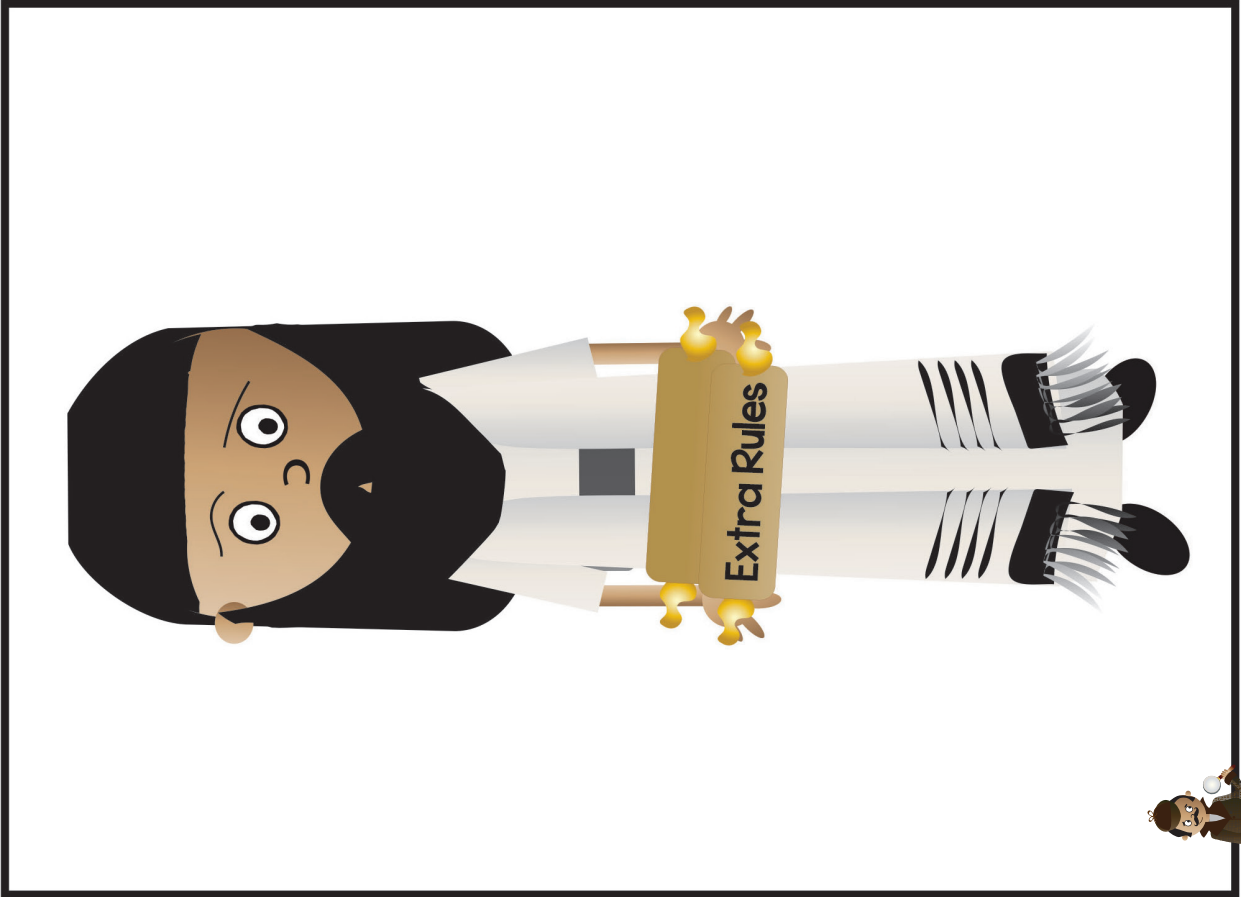

A Pharisee

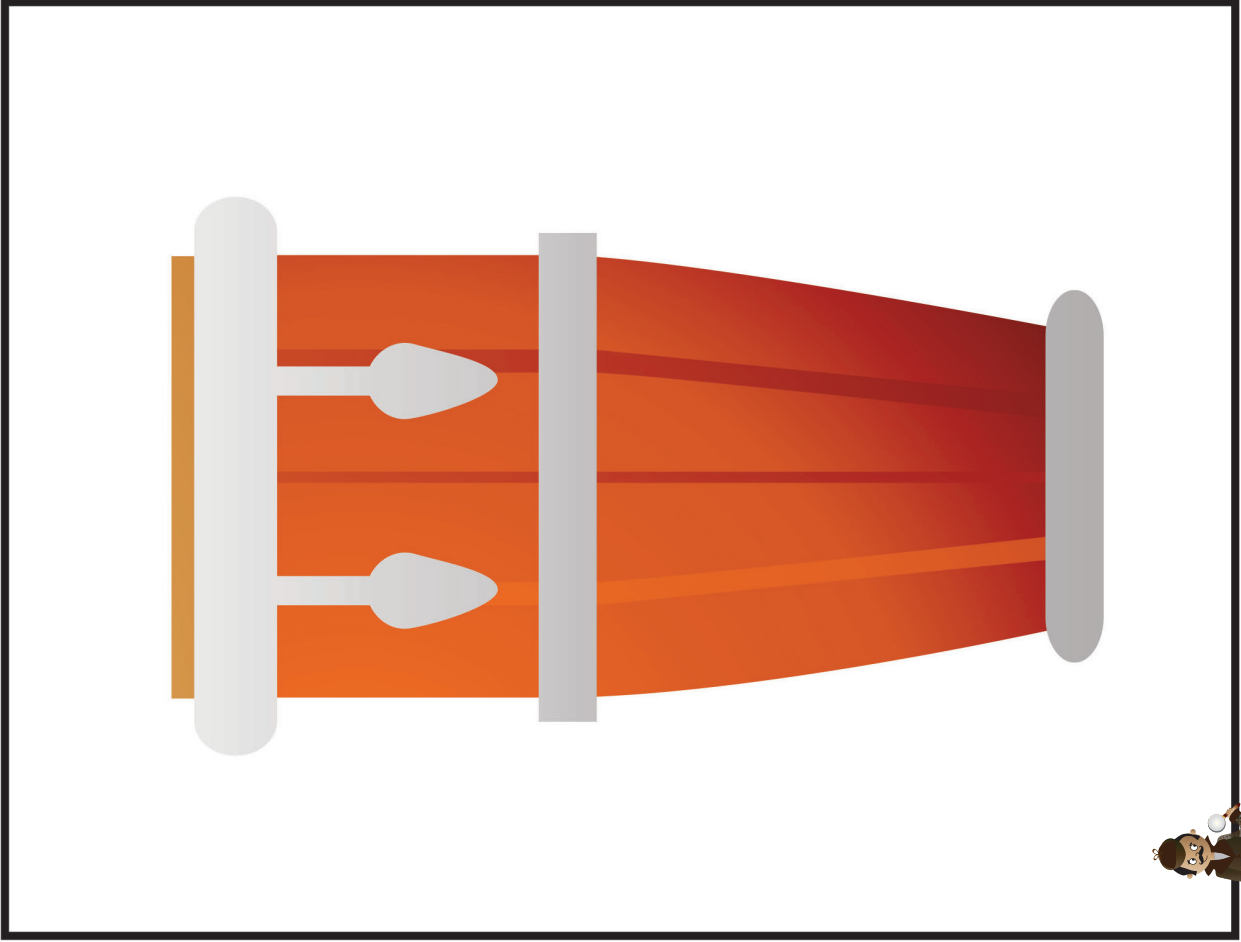

A Drum

VISUAL
AID
#5C

Place in
DDD
Bible™

take out
Big
Question
Briefcase
of BQB

VISUAL
AID
#5C

Place in
DDD
Bible™

take out
Big
Question
Briefcase
of BQB

DDD 7.2 Lesson 3 Listening Assignment Clue Picture 2 for kids

DDD 7.2 Lesson 3 Listening Assignment Clue Picture 1 for kids

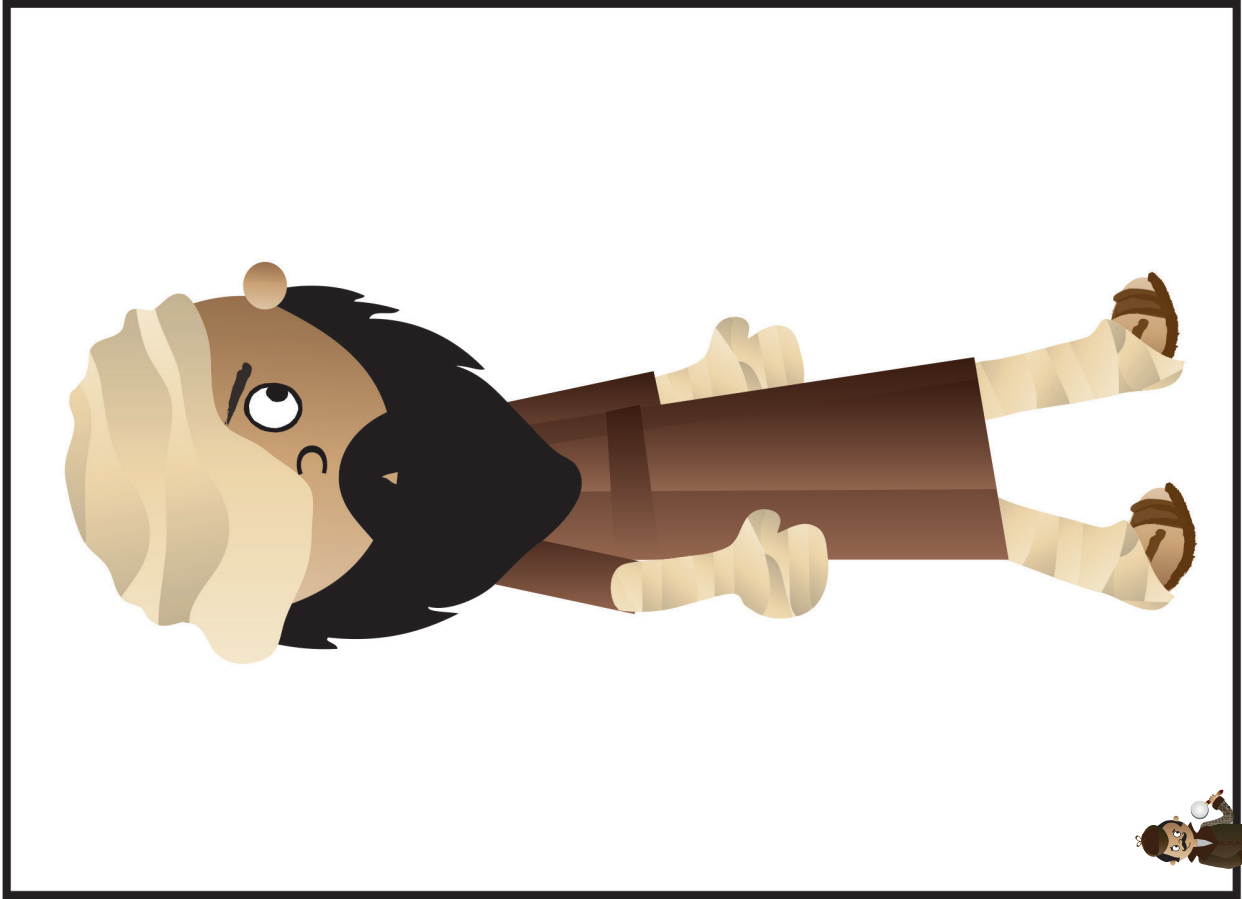

A Sick Man

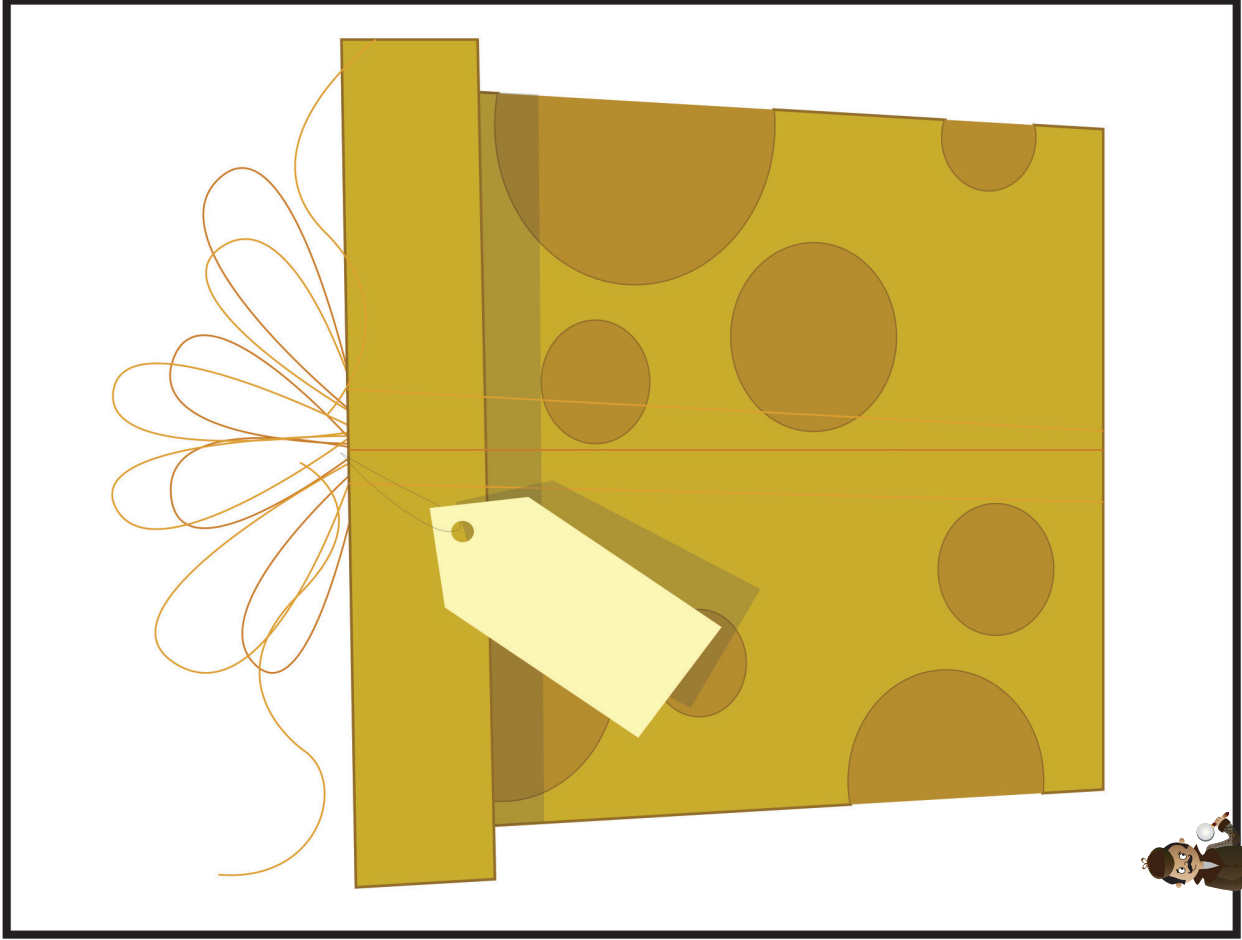

A Golden Box

VISUAL
AID
#5C

Place in
DDD
Bible™

take out
Big
Question
Briefcase
of BQB

VISUAL
AID
#5C

Place in
DDD
Bible™

take out
Big
Question
Briefcase
of BQB

DDD 7.2 Lesson 3 Listening Assignment Clue Picture 4 for kids

DDD 7.2 Lesson 3 Listening Assignment Clue Picture 3 for kids

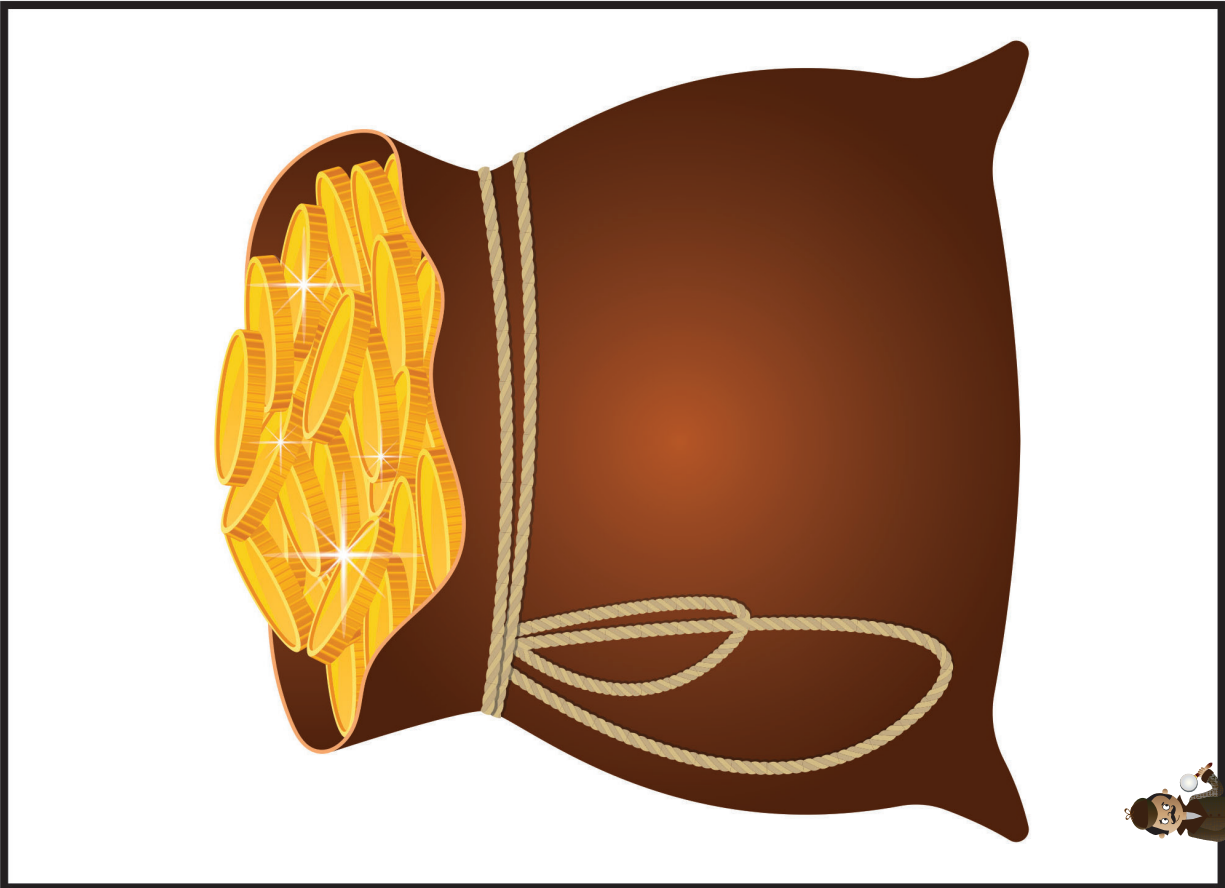

A Bag of Money

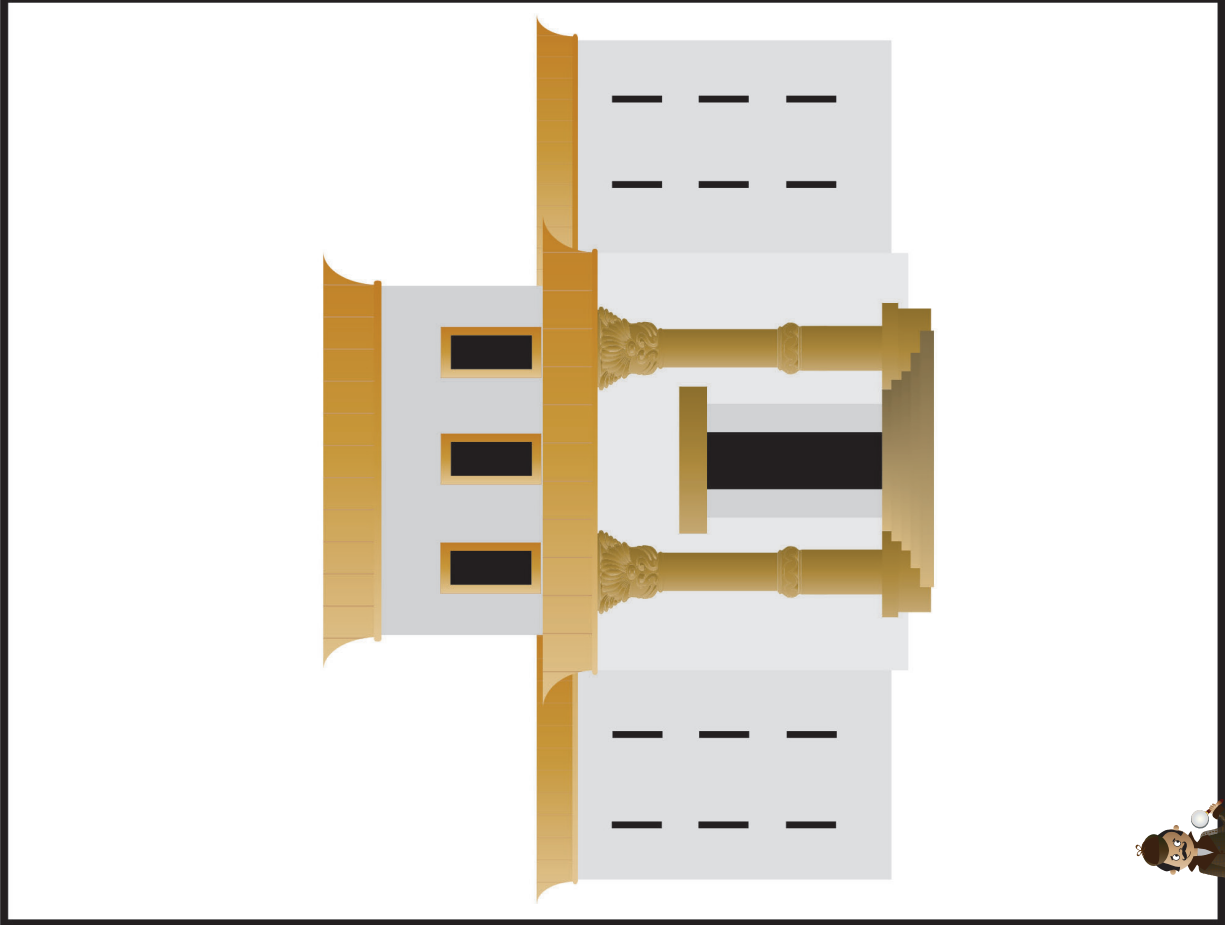

The Temple

VISUAL
AID
#5C

Place in
DDD
Bible™

take out
Big
Question
Briefcase
of BQB

VISUAL
AID
#5C

Place in
DDD
Bible™

take out
Big
Question
Briefcase
of BQB

DDD 7.2. Lesson 3 Listening Assignment Clue Picture 6 for kids

DDD 7.2. Lesson 3 Listening Assignment Clue Picture 5 for kids

“The Case of the Rotten Innards” Luke 18:9-14

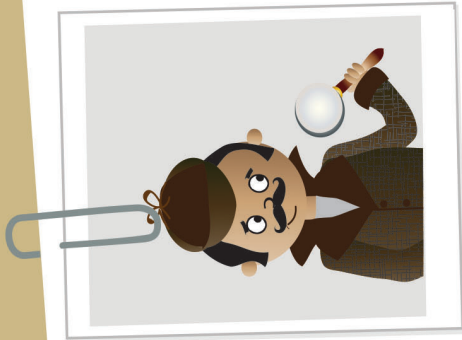

Detective Dan's Listening Assignment #1

“Innards” is a funny word that means a person's insides. And in this case, it means a person's heart, meant to love and obey God.

1. Who had a rotten heart and knew it? Who had a rotten heart and DIDN'T know it?
2. What did Jesus want them all to do?



Detective Dan's Listening Assignment #2

Romans 3:20-22, HCSB

“For no one will be justified in [God's] sight by the works of the law... But now, apart from the law, God's righteousness has been revealed... God's righteousness through faith in Jesus Christ, to all who believe.”

1. Who thought they were justified (good) in God's sight? Why weren't they?
2. What did Jesus want these people to do?

(more listening and discussion questions are included in the curriculum at praisefactory.org)

I. Many sick people came to see Jesus. They came with their limping legs, their blind eyes, their skin with sores, and their bleeding that wouldn't stop. Some of them were about to die.

They all came to Jesus, and what do you think Jesus did? Jesus healed them with God's power! No doctor or medicine needed!

"Who has ever healed sick people the way Jesus does?" they exclaimed.

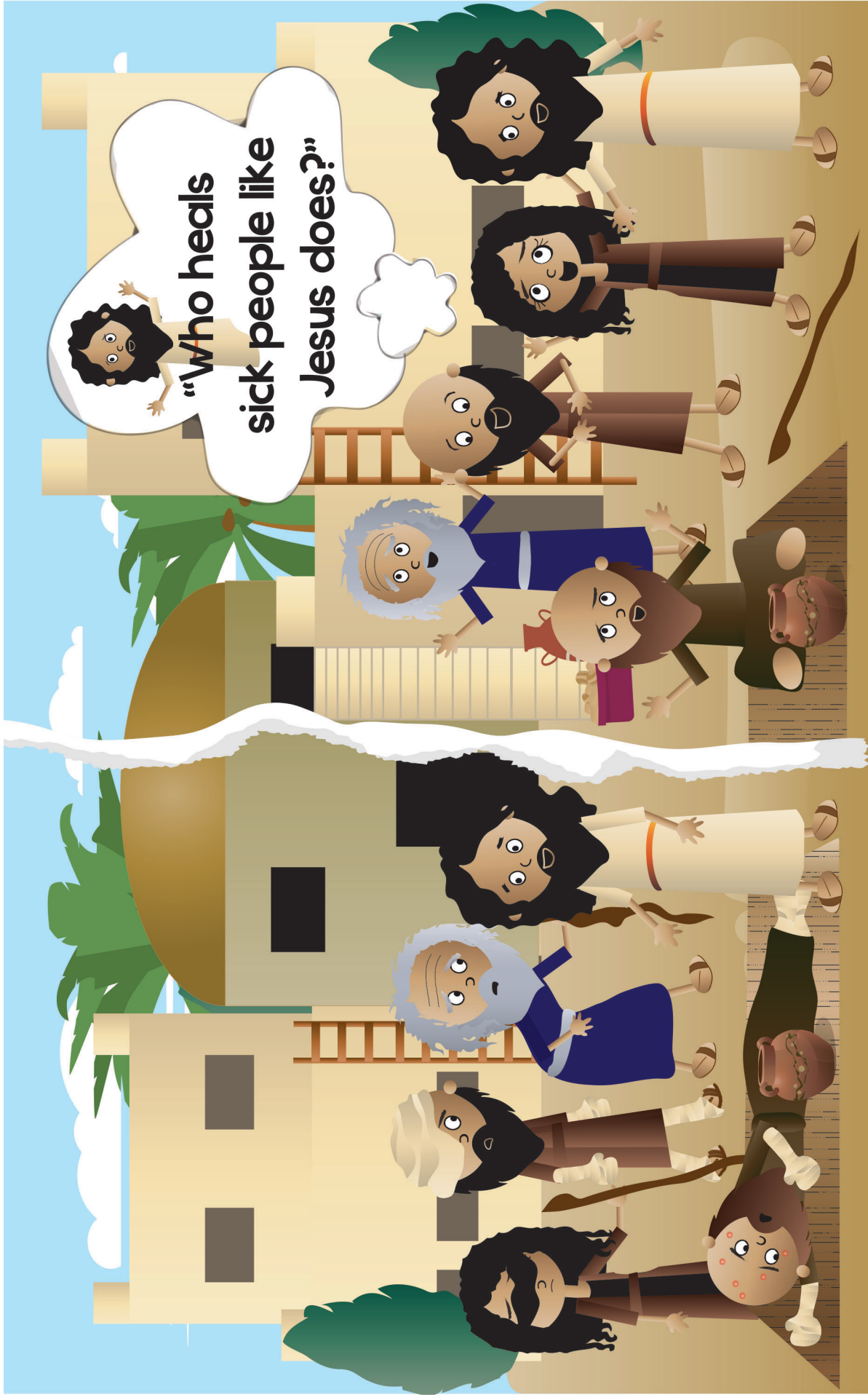

I. Many sick people came to see Jesus. They came with their limping legs, their blind eyes, their skin with sores, and their bleeding that wouldn't stop. Some of them were about to die. They all came to Jesus, and what do you think Jesus did? Jesus healed them with God's power! No doctor or medicine needed! "Who has ever healed sick people the way Jesus does?" they exclaimed.

2. People who wanted to hear about God came to Jesus, too.

They crowded around Jesus, listening to everything He had to say. Jesus told them about God and His Kingdom. He told them how God wanted them to live. They listened to Jesus and were amazed at what He had to say.

“Who has ever told us about God the way Jesus does?” they exclaimed.



2. People who wanted to hear about God came to Jesus, too. They crowded around Jesus, listening to everything He had to say. Jesus told them about God and His Kingdom. He told them how God wanted them to live. They listened to Jesus and were amazed at what He had to say. "Who has ever told us about God the way Jesus does?" they exclaimed.

3. Even people who had done very sinful things came to Jesus.

Men and women who had disobeyed God's Ten Commandments in so many ways: people who had stolen money; people who had not loved their husbands or wives; people who had hurt other people; people who had worshipped other gods, and so many more.

They all came to Jesus, and what do you think happened? Jesus gave them God's forgiveness, when they turned away from their sins and trusted in Him.

"Who has ever forgiven sins the way Jesus does?" they exclaimed.



3. Even people who had done very sinful things came to Jesus. Men and women who had disobeyed God's Ten Commandments in so many ways: people who had stolen money; people who had not loved their husbands or wives; people who had hurt other people; people who had worshipped other gods, and so many more. They all came to Jesus, and what do you think happened? Jesus gave them God's forgiveness, when they turned away from their sins and trusted in Him. "Who has ever forgiven sins the way Jesus does?" they exclaimed.

4. Sick people, sinful people, people eager to learn about God, all came to Jesus, and He satisfied them. How wonderful, how amazing was Jesus!



4. Sick people, sinful people, people eager to learn about God, all came to Jesus, and He satisfied them. How wonderful, how amazing was Jesus!

5. But there was another kind of people who came to Jesus, too.

These people were different from all the rest. They weren't sick. They weren't eager to learn about God from Jesus. And most of all, they didn't even think they were sinners who needed God's forgiveness. They were the important Bible teachers back in Jesus' day.

They had a special name for themselves. Do you know what it was? They were called the Pharisees.



5. But there was another kind of people who came to Jesus, too. These people were different from all the rest. They weren't sick. They weren't eager to learn about God from Jesus. And most of all, they didn't even think they were sinners who needed God's forgiveness. They were the important Bible teachers back in Jesus' day. They had a special name for themselves. Do you know what it was? They were called the Pharisees.

6. The Pharisees were smart students, and they studied hard.

Not only did they learn and try to obey God's Ten Commandments, but they learned and tried to obey the hundreds of God's other laws, too. They spent day after day, week after week, year after year, learning them all by heart! Wow!



6. The Pharisees were smart students, and they studied hard. Not only did they learn and try to obey God's Ten Commandments, but they learned and tried to obey the hundreds of God's other laws, too. They spent day after day, week after week, year after year, learning them all by heart! Wow!

7. But obeying God's laws wasn't enough for the Pharisees.

They wanted to be extra careful to please God, so they added a lot of extra, little rules for everyone to obey. Rules that God didn't give His people. They added extra rules about washing your hands just right. (Not to get rid of dirt or germs that might make you sick, as we do, but because they thought these specially cleaned hands were how you pleased God.)



7. But obeying God's laws wasn't enough for the Pharisees. They wanted to be extra careful to please God, so they added a lot of extra, little rules for everyone to obey. Rules that God didn't give His people. They added extra rules about washing your hands just right. (Not to get rid of dirt or germs that might make you sick, as we do, but because they thought these specially cleaned hands were how you pleased God.)

8. Those hand-washing rules were just the beginning of what the Pharisees added to God's laws.

There were also extra rules about food to eat or not eat, about giving extra gifts to God, and about what work you could NOT do on the Sabbath Day of Rest (such as not looking in a mirror because you might be tempted to pluck out a gray hair from your head), and lots more extra, little rules besides these! So many rules!



Extra Rules

8. Those hand-washing rules were just the beginning of what the Pharisees added to God's laws. There were also extra rules about food to eat or not eat, about giving extra gifts to God, and about what work you could NOT do on the Sabbath Day of Rest (such as not looking in a mirror because you might be tempted to pluck out a gray hair from your head), and lots more extra, little rules besides these! So many rules!

9. The Pharisees tried very hard to obey all their extra, little rules. They wanted the people to obey them, too.

They thought those extra, little rules helped everyone keep God's big laws better. They thought those extra rules pleased God and made them good people.

And most of all, the Pharisees thought God might send the Messiah, the Savior, sooner if everyone was very good, and kept all the little, bitty rules as well as God's big laws. Oh, how they wanted the Messiah to come!



9. The Pharisees tried very hard to obey all their extra, little rules. They wanted the people to obey them, too. They thought those extra, little rules helped everyone keep God's big laws better. They thought those extra rules pleased God and made them good people. And most of all, the Pharisees thought God might send the Messiah, the Savior, sooner if everyone was very good, and kept all the little, bitty rules as well as God's big laws. Oh, how they wanted the Messiah to come!

10. But those Pharisees were wrong about so many things! They didn't realize that the Messiah, the Savior, HAD come already. He was right there, living among them, teaching them about God, and doing amazing things by God's power.

Can you tell me who God's Savior was? It was Jesus!



10. But those Pharisees were wrong about so many things! They didn't realize that the Messiah, the Savior, HAD come already. He was right there, living among them, teaching them about God, and doing amazing things by God's power. Can you tell me who God's Savior was? It was Jesus!

II. And the Pharisees were wrong about something else, too. Instead of becoming good, good, good people when they kept all of these extra little, bitty, rules, these Pharisees became proud, proud, proud people!

“We are better than everyone else because we do such a good job obeying all these extra, little, bitty rules,” many of them thought.

“We’re so good that we don’t need God’s forgiveness, as other people do. God is pleased with us just the way we are!” they believed.

Good, Good, Good



Proud, Proud, Proud



II. And the Pharisees were wrong about something else, too. Instead of becoming good, good, good people when they kept all of these extra little, bitty, rules, these Pharisees became proud, proud, proud people! “We are better than everyone else because we do such a good job obeying all these extra, little, bitty rules,” many of them thought. “We’re so good that we don’t need God’s forgiveness, as other people do. God is pleased with us just the way we are!” they believed.

12. How very wrong those Pharisees were! All those extra, little, bitty rules they made up didn't please God. Why, even trying very hard to obey all of God's big laws isn't enough to please God!

There is only ONE WAY to please God by obeying His laws. Do you know what it is? It is being PERFECT. That's right! It's obeying God's laws ALL THE TIME!

Never disobeying ..EVER! Never saying anything wrong or doing anything wrong. Never thinking anything wrong or BEING anything wrong. Do you think that sounds like something those Pharisees could do?

Perfect?

The LORD

1. Love Me most of all

2. Don't worship fake gods. Worship only Me

3. Love Me by how you talk about Me and how you live

4. Keep a special day to rest and to worship Me

5. Love and obey your mother and father

6. Don't murder people

7. Keep your promise to love only your husband/wife

8. Don't lie

9. Don't take other people's things

10. Be happy with what I give you. Don't be greedy for what others have

God's Laws

12. How very wrong those Pharisees were! All those extra, little, bitty rules they made up didn't please God. Why, even trying very hard to obey all of God's big laws isn't enough to please God! There is only ONE WAY to please God by obeying His laws. Do you know what it is? It is being PERFECT. That's right! It's obeying God's laws ALL THE TIME! Never disobeying ...EVER! Never saying anything wrong or doing anything wrong. Never thinking anything wrong or BEING anything wrong. Do you think that sounds like something those Pharisees could do?

**13. No, the Pharisees could not be this good. They had “rotten innards”
--sinful hearts-- just like everyone else. They would never be able
to please God by trying to be good.**

**And guess what? Neither can we. Why? Because every one of us
has a sinful heart, too. Every one of us has broken God's laws. We
all need God's forgiveness for our sins. That is the only way we can
know and please God. That's the only way we can live with God as
His people.**



13. No, the Pharisees could not be this good. They had “rotten innards” --sinful hearts-- just like everyone else. They would never be able to please God by trying to be good. And guess what? Neither can we. Why? Because every one of us has a sinful heart, too. Every one of us has broken God's laws. We all need God's forgiveness for our sins. That is the only way we can know and please God. That's the only way we can live with God as His people.

14. But these poor, proud Pharisees would just not see this. They were SURE that they were already good enough to please God, and they were SURE that all those other people who came to Jesus were not.

So, what did Jesus do with these proud men who thought they were so good? Jesus loved them, that's what He did. Jesus wanted to help them, just like He wanted to help everyone else who came to Him.

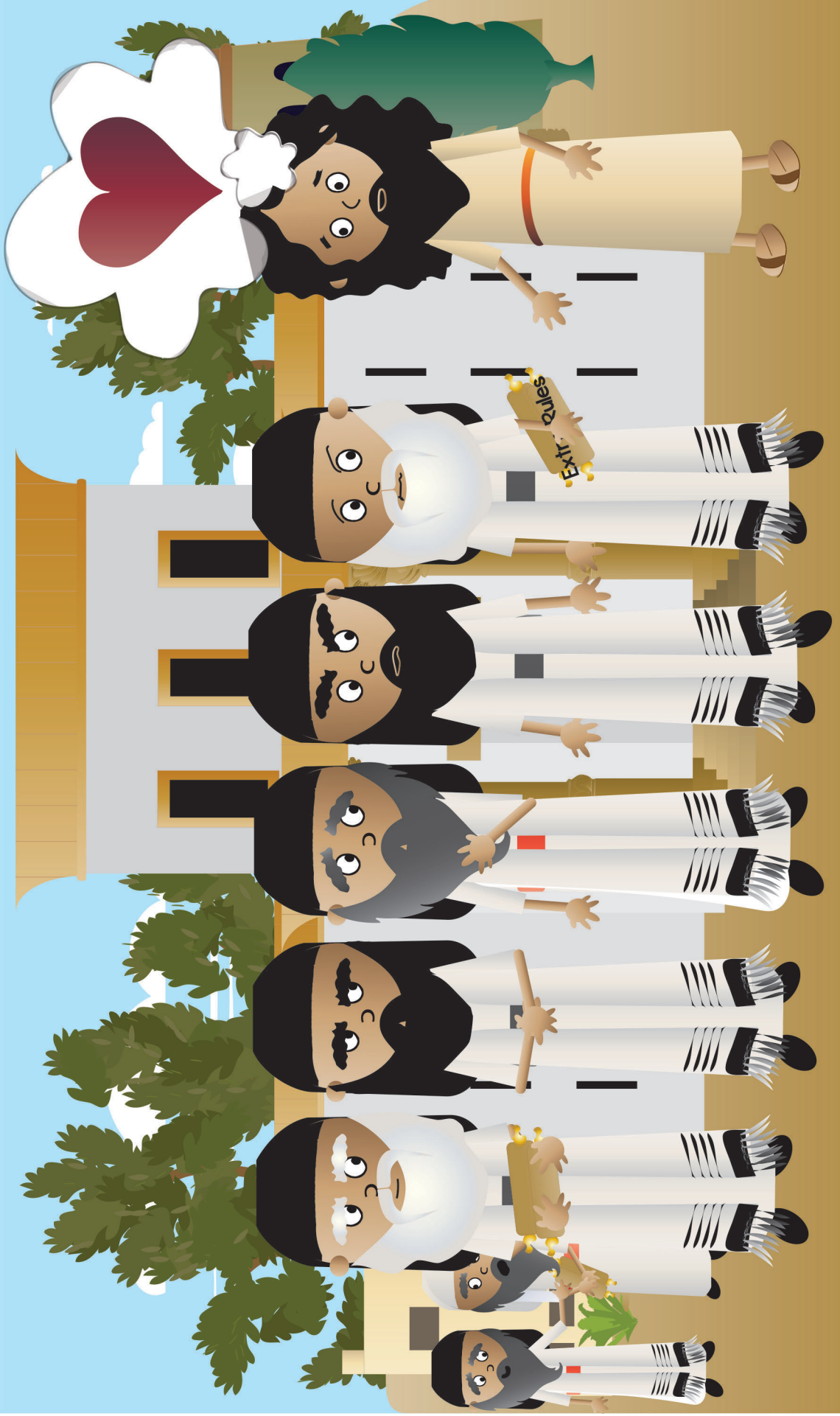

14. But these poor, proud Pharisees would just not see this. They were SURE that they were already good enough to please God, and they were SURE that all those other people who came to Jesus were not. So, what did Jesus do with these proud men who thought they were so good? Jesus loved them, that's what He did. Jesus wanted to help them, just like He wanted to help everyone else who came to Him.

15. So, Jesus told them a story to help them see that they needed God to save them and forgive them, just like everyone else did. Maybe then they would understand that they were sinners and would ask God for forgiveness. This is the story Jesus told them...

“One day, two men went to God’s Temple (the worship place) to pray. One man was a Pharisee. The other man was a tax collector,” Jesus said.

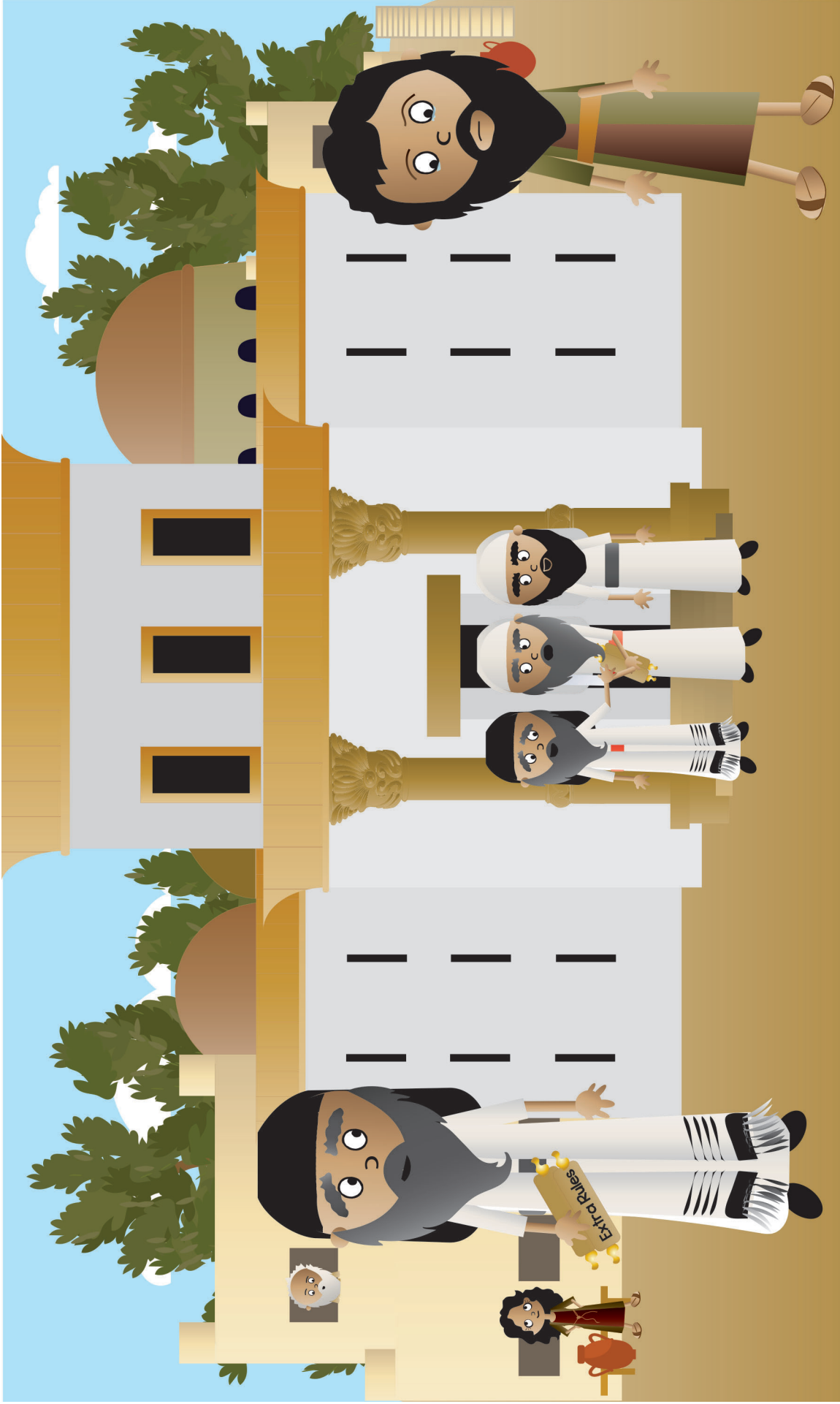

15. So, Jesus told them a story to help them see that they needed God to save them and forgive them, just like everyone else did. Maybe then they would understand that they were sinners and would ask God for forgiveness. This is the story Jesus told them...

“One day, two men went to God’s Temple (the worship place) to pray. One man was a Pharisee. The other man was a tax collector,” Jesus said.

16. “The Pharisee thought of himself as a very good man who pleased God by obeying God’s laws and the teachers’ extra rules.”

“So, he stretched his arms up high and looked up to heaven, and proudly prayed, “God, thank You that I am different from other men. I’m not like that bad, tax collector over there. I don’t do the bad things they do. I am good, good, good. I keep all your laws and all the extra rules of my teachers, too,” he said.



16. "The Pharisee thought of himself as a very good man who pleased God by obeying God's laws and the teachers' extra rules. So, he stretched his arms up high and looked up to heaven, and proudly prayed, "God, thank You that I am different from other men. I'm not like that bad, tax collector over there. I don't do the bad things they do. I am good, good, good. I keep all your laws and all the extra rules of my teachers, too," he said.

17. Can you believe that? That Pharisee didn't praise GOD for being good! He only boasted to God about his OWN goodness! That Pharisee wasn't really a good, good, good man at all, was he? No! He was really a proud, proud, proud man!

Good, Good, Good

Proud, Proud, Proud

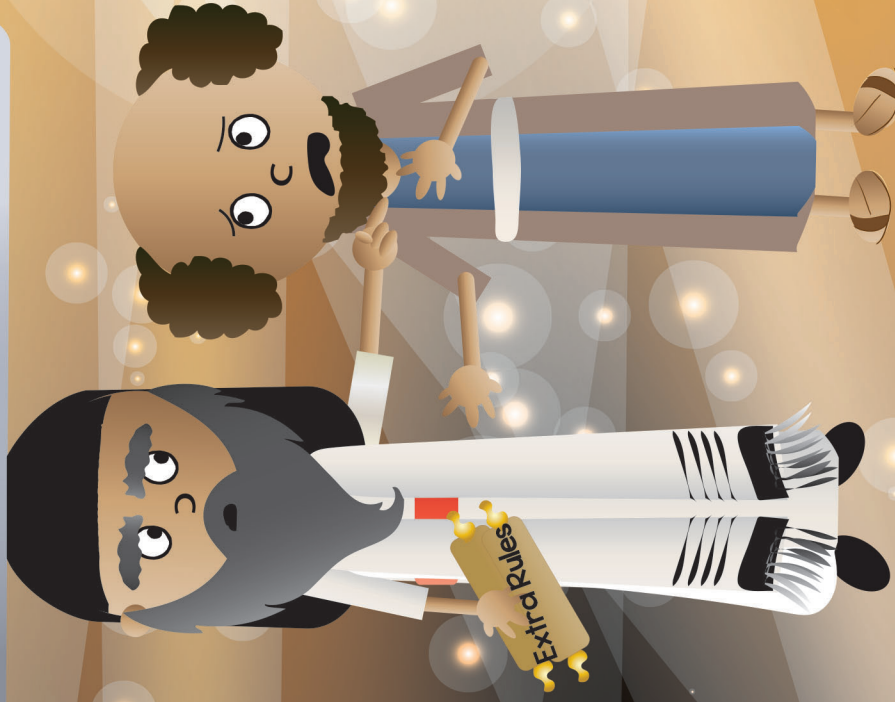

17. Can you believe that? That Pharisee didn't praise GOD for being good! He only boasted to God about his OWN goodness! That Pharisee wasn't really a good, good, good man at all, was he? No! He was really a proud, proud, proud man!

18. Then, Jesus went on with his story. He told about the other man.

“The tax collector came to the Temple knowing he was a bad, bad, bad man. He knew he had “rotten innards” --a sinful heart. He knew the sin in his heart showed in how he lived. He had chosen to disobey God’s good laws. He had chosen to become rich by taking too much money from people.”



18. Then, Jesus went on with his story. He told about the other man. "The tax collector came to the Temple knowing he was a bad, bad, bad man. He knew he had "rotten innards" --a sinful heart. He knew the sin in his heart showed in how he lived. He had chosen to disobey God's good laws. He had chosen to become rich by taking too much money from people."

19. “And when this tax collector prayed to God, it wasn’t boldly and proudly like the Pharisee.

No, this man KNEW he had done lots of bad things and he was sad about them. He was sad he had disobeyed God’s laws and treated others so badly. He KNEW he wasn’t right with God; and oh, how he wanted to be!

The tax collector was too ashamed of his sins to stretch up his arms or look up to heaven to pray. He looked down at his feet, beat his chest, and cried out to God, “God, have mercy on me! I am so bad. I have disobeyed Your laws. I have a sinful heart. Have mercy on me! Please, forgive my sins!”

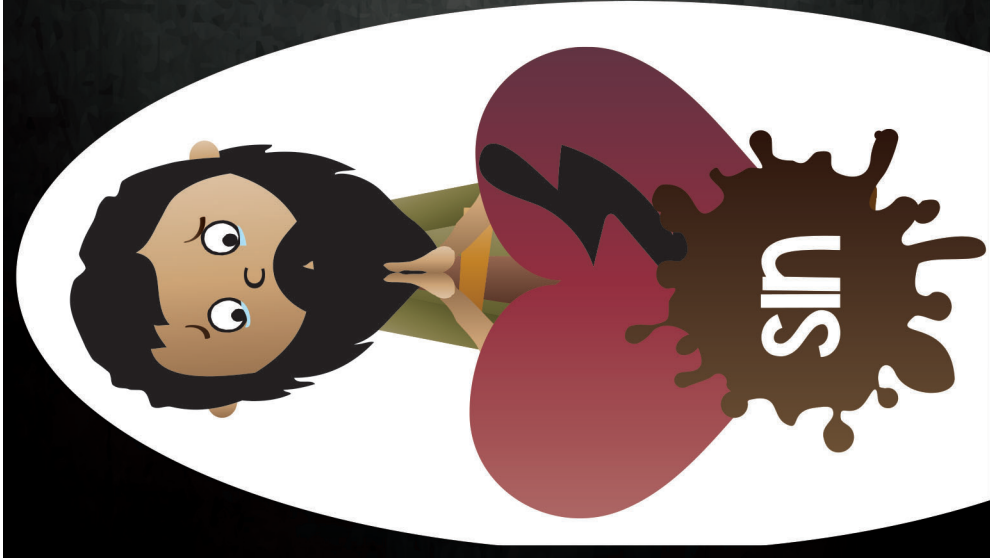

THE LORD

19. “And when this tax collector prayed to God, it wasn’t boldly and proudly like the Pharisee. No, this man **KNEW** he had done lots of bad things and he was sad about them. He was sad he had disobeyed God’s laws and treated others so badly. He **KNEW** he wasn’t right with God; and oh, how he wanted to be! The tax collector was too ashamed of his sins to stretch up his arms or look up to heaven to pray. He looked down at his feet, beat his chest, and cried out to God, “God, have mercy on me! I am so bad. I have disobeyed Your laws. I have a sinful heart. Have mercy on me! Please, forgive my sins!”

20. Then, Jesus told the Pharisees listening to Him: “The Pharisee went home feeling proud. He was so sure that his life pleased God, but he was wrong. God is not pleased with proud people who don’t see that they are sinners who need His forgiveness,” Jesus told them.

“But the tax collector, who knew he was a sinner, went home forgiven by God,” Jesus said. “God loves to forgive sinners --even very bad sinners-- who confess their sins to Him and humbly ask for His forgiveness,” Jesus told them.



20. Then, Jesus told the Pharisees listening to Him: “The Pharisee went home feeling proud. He was so sure that his life pleased God, but he was wrong. God is not pleased with proud people who don’t see that they are sinners who need His forgiveness,” Jesus told them. “But the tax collector, who knew he was a sinner, went home forgiven by God,” Jesus said. “God loves to forgive sinners --even very bad sinners-- who confess their sins to Him and humbly ask for His forgiveness,” Jesus told them.

21. What did the Pharisees think of Jesus' story?

Did they learn from it? Did they see that everyone has broken God's laws, even people, like themselves, who tried really hard to be good? Did they, at last, see that no one can ever do enough good things to be proud before God? Did they see their own sins and ask God to forgive them?



21. What did the Pharisees think of Jesus' story? Did they learn from it? Did they see that everyone has broken God's laws, even people, like themselves, who tried really hard to be good? Did they, at last, see that no one can ever do enough good things to be proud before God? Did they see their own sins and ask God to forgive them?

22. The Bible doesn't tell us what happened with those Pharisees that day.

But, we DO know that later, some of these very important teachers --like Joseph of Arimathea and Nicodemus-- DID turn away from their sins and asked God to forgive them. They put their trust in Jesus as their Savior.

And did you know that these two men were the very ones who put Jesus' body in the cave-grave, after He had suffered and died on the cross?



22. The Bible doesn't tell us what happened with those Pharisees that day. But, we DO know that later, some of these very important teachers --like Joseph of Arimathea and Nicodemus-- DID turn away from their sins and asked God to forgive them. They put their trust in Jesus as their Savior. And did you know that these two men were the very ones who put Jesus' body in the cave-grave, after He had suffered and died on the cross?

23. How amazed and happy they both must have been when Jesus rose from the dead on the third day!

Jesus really was the Messiah, the Savior, God had sent to save His people and forgive their sins! He had beaten sin and death for all who turn away from their sins and trust in Him as their Savior. Jesus can be our Savior, too, if we do this, too. Ask Him to help you!



23. How amazed and happy they both must have been when Jesus rose from the dead on the third day! Jesus really was the Messiah, the Savior, God had sent to save His people and forgive their sins! He had beaten sin and death for all who turn away from their sins and trust in Him as their Savior. Jesus can be our Savior, too, if we do this. Ask Him to help you!

DDD 7.2 Simple Story Scenes

“The Case of the Rotten Innards” Luke 18:9-14

SOLVED

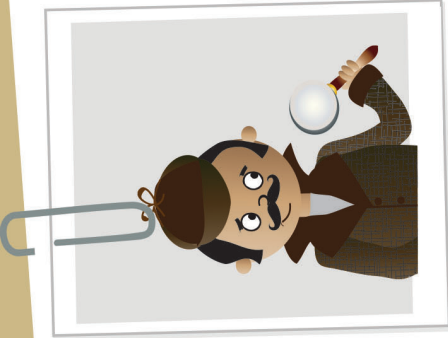

Detective Dan's Listening Assignment #1

“Innards” is a funny word that means a person's insides. And in this case, it means a person's heart, meant to love and obey God.

1. Who had a rotten heart and knew it? Who had a rotten heart and DIDN'T know it? Many of the people who came to see Jesus knew they had disobeyed God's laws and were sinners. They knew they needed God's forgiveness. The Pharisees were also sinners with “rotten hearts,” but they didn't know it. They thought they pleased God with all the laws they kept and all the good things they thought they did.

2. What did Jesus want them all to do? Jesus wanted everyone to turn away from their sins, ask God for forgiveness, and trust in Him as their Savior.

For You and Me:
Just like everyone in Jesus' day, we, too, have sinful “rotten” hearts. We all break God's laws, and we need His forgiveness. We can have His forgiveness when we turn away from our sins and trust in Jesus as our Savior. God will forgive our sins and make us His people. Ask God to help you! He loves to answer this prayer!



Detective Dan's Listening Assignment #2

Romans 3:20-22, HCSB

“For no one will be justified in [God's] sight by the works of the law...But now, apart from the law, God's righteousness has been revealed... God's righteousness through faith in Jesus Christ, to all who believe.”

1. Who thought they were justified (good) in God's sight? Why weren't they? The Pharisees thought they were justified in God's sight because they obeyed God's laws and the extra rules. They weren't justified because no one (except Jesus) obeys God's laws perfectly ---and that's the only way to be justified by obeying God's law.

2. What did Jesus want these people to do? He wanted them to understand that they were sinners who needed to turn to God and ask for His forgiveness. He wanted them to trust in Him as their Savior, so they might be saved from their sins.

For You and Me:

Just like the Pharisees, we also cannot be justified (made right with God) by doing good things and trying to obey God's laws. We will never obey them perfectly. We all break God's laws and we need His forgiveness. We can have His forgiveness when we turn away from our sins and trust in Jesus as our Savior. God will forgive our sins and make us His people. Ask God to help you! He loves to answer this prayer!

DDD 7.2 Simple Story Scenes

What Are God's Laws Like?
God's Laws Are Perfect...
they show us that we need God to save us!

The Gospel



God's laws are perfect. They show us how God requires us to live. But the sad truth is, we all break God's good laws. That's why we all deserve His punishment, and that's why we all need God to save us! Only He can make it possible for us to become His people. And that's exactly what He did through Jesus, His Son.

Jesus came and lived a perfect life. He kept every, single one of God's laws! Then, He offered up His perfect life to God as the full payment for the sins of God's people, when He suffered and died on the cross. Then on Day Three, Jesus rose from the dead in victory. Jesus had beaten sin and death for God's people!

We can be God's people, too, when we turn away from our sins and trust in Jesus as our Savior.

He loves to help us do this. Ask Him!



DDD 7.2 Simple Story Scenes

A Prayer

A We praise You, God, for being the Giver of Your perfectly good laws.

C God, instead of obeying Your good laws, we have all chosen to break them. Sometimes, we don't obey our parents. Sometimes, we lie. Sometimes, we want things that belong to others. We do not always love you most of all. These are only some of the ways we break Your good laws. Oh, how we need a Savior!

T Thank You, God, for giving us Your good laws, so we know how to love and obey You. And thank You for sending Jesus to perfectly live out Your laws and to give His life as the perfect payment for the sins of Your people. Thank You that He can be our Savior, too, when we turn away from our sins and trust in Him.

S God, work in our hearts. Help us to turn away from disobeying You and trust in Jesus as our own Savior. Help us to know You, love You, and live for You. Help us to learn Your good laws and obey them.

In Jesus' name we pray. Amen.



DDD 7.2 Simple Story Scenes

DEEP DOWN DETECTIVES



Visual Aids

Unit 7,

Bible Truth 3

About the Deep Down Detectives Visual Aids

How Are They Used?



The Deep Down Detectives Visual Aids book is a companion resource to be used alongside the Deep Down Detectives Core Curriculum book for each unit. These colorful pictures are used in presenting the key concepts; telling the Bible stories; and, in playing the Bible Story Review games.

What Do They Include?



There are four different resources included in this book:

1. Key Concept Visual Aids-- colorful signs of the Big Question and Answer, the Bible Truth, the Bible verse, and the Listening Assignments to use with the 3 lessons for each Bible Truth.

2. The Story Scenes Placement Page--where to place the pictures on your storyboard.

3. The Story Scenes, themselves. Notice that each scene is numbered and that there is a brief summary of the story that corresponds to the picture. You can actually just tell the story in a simple way by using only the text at the bottom of each Story Scene.

5. Directions for making the Deep Down Detectives "Bible" Folder and the **back/front images** to paste in place when making it. (Larger back/front images are found online with the curriculum.)

Directions for how to make a homemade flannelgraph storyboard and sturdy Story Scene pictures are found in the back of this book.

Ready, Set, Rip It Out!

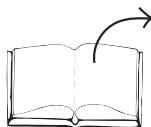

This book is meant to be ripped up and made into your visual aids. The key concept signs can be cut out and laminated or slipped into sheet protectors. The Story Scenes can be put in sheet protectors or laminated, too.

Store It!



Deep Down Detectives is a curriculum that can be used over and over. Store your visual aids and storyboard pictures after using them and they will serve you for many years. We store ours in manilla envelopes and then put them (along with all the rest of the curriculum) in magazine files, labelled by Bible Truth. If you have multiple classes using the curriculum, store each set of resources in separate manilla envelopes. This will make prep much simpler, second time around.

Replacement Story Scene Pictures



You can always purchase this book again or simply go online and print out any scenes that go missing.

Other Options



You can also choose to tell the story in a more traditional flannelgraph way by using your own flannelgraph figures or by purchasing/free downloading the Storyboard Pictures (large and small format size available). This is more complex and requires more preparation, but some love it. And, it does allow for kids to interact more by helping to place pictures up on the board as you tell the story.

Unit 7: God, the Just and Merciful

Unit Big Question (and Answer): What Are God's Laws Like? God's Laws Are Perfect!

Unit Bible Verse: "The law of the LORD is perfect." Psalm 19:7

Bible Truth 3 Concept: God's Laws Are Perfect... They Tell Us How to Love God and Others!

The LORD is the one, true God. He deserves our love. He made us to love Him more than anything else. Loving God is the most delightful thing we can do. God gave us His laws so we can know how to love Him. When we obey His laws, we are living out our love for Him.

God made us not just to love Him, but also to love each other. He gave His laws so we can know how to love each other. He tells us to treat others in the same loving way we want others to treat us. When we obey God's laws, we are living out God's love for others. And, we are showing them a little bit of what God is like, that they might seek to know and love Him, too.

Obeying God's laws is not just the right way to live. It is also the happiest way to live with God and with other people. God can help us obey His laws and live in love when we turn away from our sins and trust in Jesus as our Savior. He gives us a new heart filled with His Holy Spirit and helps us to live in love as He wants us to.

Bible Truth 3 Bible Verse: Matthew 22:37-40, ESV

"You shall love the Lord your God with all your heart and with all your soul and with all your mind. This is the great and first commandment. And a second is like it: You shall love your neighbor as yourself. On these two commandments depend all the Law and the Prophets."

Learn a Little: "Love the Lord your God with all your heart, soul and mind... Love your neighbor as yourself."

Meaning

God has given us many laws in the Bible. It's good to know them all. But Jesus tells us in these verses that the purpose behind all of God's laws is to love God most of all, and to love others as we love ourselves. When we live out all His good laws, we are loving God and love others as He wants us to.

Bible Truth 3 ACTS Prayer

- A** We praise You, God, for being the Giver of Your perfectly good laws that show us how to love You and others.
- C** God, many times, we do not obey Your good laws. Many times, we do not love You or others as Your laws tell us to. We need a Savior!
- T** Thank You, God, for giving us Your good laws that show us how to love You and others. Thank You for sending Your Holy Spirit to live in our hearts when we trust in Jesus as our Savior. He helps us to obey Your good and loving laws.
- S** God, work in our hearts. Help us to turn away from our sins and trust in Jesus as our Savior. Send Your Holy Spirit to live inside our hearts and help us to love You and others as You want us to.
In Jesus' name we pray, Amen.

Bible Truth 3 Story**The Case of the Do's and Don'ts**

Matthew 5,6,22

Songs Used in Bible Truth 3

Big Q & A 7 Song

Big Question 7 Song: What Are God's Laws Like?

Big Question 7 Bible Verse Song: The Law of the Lord Psalm 19:7, ESV

Extra Big Question 7 Bible Verse Song: The Law of the Lord Is Perfect Psalm 19:7, ESV (full version)

Big Question 7 Hymn: Holy Bible, Book Divine

Big Question 7 Praise Song: The Best Book to Read Is the Bible

Bible Truth 3 Bible Verse Song: Love the Lord Matthew 22:37-40, ESV

listen to or download songs for free at <https://praisefactory.org>: Deep Down Detectives Music page

The Case of the Do's and Don'ts

Matthew 5,6,22



Story-telling Tips

Ahead of time:

1. Read the Bible verses and story. Pray!
2. Choose story action cues and/or prepare storyboard figures, if using. (Included in Visual Aids book)
3. Practice telling story with the storyboard pictures, timing your presentation. Shorten, if necessary.

During your presentation:

1. Maintain as much eye contact as possible as you tell the story.
2. Put up storyboard figures/add story action cues as you tell the story. Allow the children to help you put them on the board, if desired.
3. Include the children in your story with a few questions about what they think will happen or words/concepts that might be new to them.
4. Watch the kids for signs that their attention span has been reached. Shorten, if necessary.

INTRODUCTION/ LISTENING ASSIGNMENTS

"Our story is called: The Case of the Do's and Don'ts. Here is your listening assignment." Read from Detective Dan's Listening Assignment signs, but questions are summarized below:

Detective Dan's Lesson #1 Listening Assignment:

I need to know:

- 1. Who made up extra, little rules of do's and don'ts?**
- 2. What did Jesus think of those extra do's and don'ts? What did Jesus say God's real laws help people do?**

Detective Dan's Lesson #2 Listening Assignment:

Our Bible Verse is Matthew 22:37-40:

"You shall love the Lord your God with all your heart and with all your soul and with all your mind. This is the great and first commandment. And a second is like it: You shall love your neighbor as yourself. On these two commandments depend all the Law and the Prophets."

I need to know:

- 1. Which laws did Jesus tell people to obey?**
- 2. Who is the only person to obey God's laws perfectly? How did He share His perfect life with us?**

Detective Dan's Lesson #3 Listening Assignment:

I found six clues, but two of them are **NOT** in the story.

They are: a pillow, a cup, two fish, a painter, a heart, and God's Ten, Big Laws.

Hold each of them up for the children to see as you identify them.

I need to know:

- 1. Which four belong in the story and which two don't?**
- 2. Who can help us keep God's laws and love others?**

Read the assignment questions, THEN SAY,

"Ok, Deep Down Detectives! Put on your best listening ears and see if you can hear the answers to Detective Dan's questions. When I finish telling the story, we will see if we can answer all the questions."

Read the Bible Truth story, answer questions, present the gospel and lead in prayer.

Answers to questions; the gospel; and, ACTS prayer are included with the story text.

The Case of the Do's and Don'ts

*Matthew 5,6,22**Story with lines separating paragraphs (text in bold, optional interaction cues in italics)*

Rules! Rules! Rules! So many rules for God's people to keep! "Do this! Don't do that!" the teachers in Jesus' day (the Pharisees) taught the people. Of course, there were the Ten, Big Laws (the Ten Commandments) that God had given them through Moses. But there were so many more rules than that. Can you guess how many laws the Pharisees counted in God's Word for everyone to obey? Twenty? Fifty? Surely, not a hundred!

What do you think?

It was more than any of those guesses! It was 613! There were 248 DO laws and 365 DON'T laws.

But soon those 613 laws turned into even more, as the teachers made up extra ways they wanted God's people to live them out. They made up extra "DO's" like: "DO say a special prayer as you wash your hands when you wake up in the morning, or you won't please God." And extra DON'T's" like: "DON'T use the same spoon to stir milk and cook meat, or you won't please God." What a lot of rules! Oh, how they weighed down the people! Who could keep all these rules!

But then, Jesus came. He wasn't like any other teacher. He healed sick people without using any medicine! He brought dead people back to life again! He even forgave people's sins! Jesus simply spoke and God's power did these wonderful things through Him.

Jesus did other amazing things, too, like when He made the strong winds and the big waves of a huge storm at sea suddenly STOP and be calm at His command. And, when He fed a huge, hungry crowd of people with just two fish and five loaves of bread. Wow!

The news about Jesus spread quickly. Soon, many people were coming to Jesus. They came to have Him heal their sick family and friends. They came to see Him do amazing things. And, they came to hear what He had to say about God and His laws. Would Jesus be just like all the other teachers? Would He tell them to keep all those Do's and Don'ts? Would He give them lots of extra rules like the Pharisees did?

What do you think?

Soon, Jesus answered all of their questions.

One day, Jesus and a huge crowd of people climbed up, up, up a grassy mountain above the Sea of Galilee. When they reached the top, Jesus sat down and began to teach them about God's laws.

"God's laws are very important. They will last until the end of time. I have not come to get rid of even one of God's good laws," Jesus told the people. "Your teachers, the Pharisees, try to please God by adding lots of extra, little rules to God's good laws. They think all this rule-keeping will make them right with God, but it's not enough. You need something more than all their extra, little rules to please God. You will need a better righteousness than theirs, if you want to be God's people," Jesus told them.

Oh, no! This didn't sound good at all! The Pharisees worked so hard to keep all 613 laws in the Bible! And, they made up all those hundreds of extra, little rules, to try to please God, too. How could ANYONE be better than the Pharisees? Was Jesus going to give them even MORE rules to live by? It sure sounded that way.

What do you think?

Story with lines separating paragraphs (text in bold, optional interaction cues in italics)

No, Jesus was not. "Your teachers are wrong about their extra, little rules. They just weigh down people. They don't help anyone live as God wants them to live," Jesus said. "I have come to fulfill God's law. I will teach you how to really live out God's laws to please Him," He told the crowds.

"The Do's and Don'ts in God's Word are about how we show love to God and others. These laws start in the heart with love, and they tell us how God wants us to live out that love with our whole lives," Jesus explained.

"Some people LOOK like they obey God's laws, but really, they are still breaking them," Jesus told the people. "They do the right thing on the outside, but in their hearts, they are angry or jealous or hateful. God doesn't just look on the outside. He sees inside every heart. He knows the sin that is hiding there. He knows when you are angry or jealous or hateful. What goes on inside your heart breaks God's laws, too," Jesus explained.

The people listened to Jesus and were amazed! Jesus wasn't at all like the other teachers they had heard before. He didn't just give them lots of extra, little rules. He helped them see that God's laws show them how to truly love God and others. As Jesus later said: "Love the LORD with all your heart, your mind, and your strength. Love others --even your enemies-- as much as you love yourself. Do to them only what you want them to do to you. If you do love the LORD and love others like this, you will be obeying all of God's laws, because that's what God's laws are really all about."

How about that! All of those 10 Commandments, and even all of those 613 laws, really added up to only two: love the LORD and love others. Amazing!

I wonder what people were thinking as they climbed down the mountain at the end of the day. Jesus had given them less rules to follow, but they were much harder than all those 613 Do's and Don'ts in God's Word, and all those extra, little rules of the Pharisees. Anyone could remember to wash their hands when they woke up in the morning or to use a different spoon when they stirred the milk and cooked the meat. But loving God and others from the heart... that was so hard! How could they ever keep their hearts from being angry or jealous or hateful towards others? How could they really love God most of all? Could they ever really keep God's laws? Could they ever please God and really love God's people, if this was how they must live? There seemed to be no hope.

What do you think?

Well, there WAS no hope, if they had to obey God's good laws of love on their own. But praise God, they did NOT! That's why God sent Jesus! Not just to TELL the people what it really means to live out God's laws. But to DO it, HIMSELF! Yes, Jesus lived out God's laws perfectly every day He lived here on earth. He always loved God most of all. He always loved people. In everything He thought, and said, and did, Jesus fulfilled God's law completely. He pleased God with His whole life. Jesus could do this because He was the perfect Son of God. He truly loved God, His Father, and He had come to be our Savior.

And what did the Pharisees think about what Jesus taught? They did NOT like it!

They did not like that Jesus said He was God's Son. They did not like what Jesus said about them and all of their extra, little rules. And so, the Pharisees and other enemies worked together to get rid of Jesus. They nailed Him to a cross to suffer and die, and to get rid of Him, once and for all.

But God was up to good, even in the bad plans of Jesus' enemies. For on that cross, Jesus offered up His perfect life as the full payment for the sins of all who would ever turn away from their sins and trust in Him as their Savior. He took their punishment and gave them His perfect life. Now, they could please God. Not with their own lives, but with His!

Story with lines separating paragraphs (text in bold, optional interaction cues in italics)

Jesus died and was buried in a cave-grave that sad day, but did He stay there?

What do you think?

No, He did not! On the third day, He rose from the dead. Jesus had really beaten sin and death for God's people!

After Jesus rose from the dead, He appeared to His followers and taught them more about God's good plans. Best of all, He told them about God's special gift to help them live out God's law from their hearts. Do you know what that special gift was?

Can you guess?

It was the Holy Spirit!

"I am going back home to heaven, but I will send you the Holy Spirit to live in your hearts," Jesus told His followers. "He will fill your hearts with love. He will help you love God most of all. He will help you love others, too. And He will stay with you your whole lives until the day you come home to live with Me forever," Jesus promised them.

And sure enough, not long after Jesus went up to heaven, He did send the Holy Spirit to live in the hearts of God's people! How they praised God! How happy they were!

God had been so good to them through Jesus! Jesus had lived a perfect life of love and given it to them, so they could be God's people. He had sent the Holy Spirit to live inside their hearts for the rest of their lives. He would change their hearts and help them to obey God's laws and love God and others.

And, how they looked forward to the day when they would go to live with Him forever! Then, God will make all things new, even their hearts. Then, they will love God and each other perfectly. And at last, God's laws will be perfectly fulfilled, even in them! We can become God's people, too, when we turn away from our sins and trust in Jesus as our Savior. Ask Him to help you!

Cracking the Case: (story wrap-up for Listening Assignments)

It's time to see how we did with our Listening Assignment.

Detective Dan's Lesson 1 Listening Assignment:**1. Who made up extra, little rules of do's and don'ts?**

The Pharisees.

2. What did Jesus think of those extra do's and don'ts? What did Jesus say God's real laws help people to do? Jesus knew those do's and don'ts weren't what pleased God. Jesus said God's real laws help people love God most of all and love others.

For You and Me:

None of us can ever obey God's laws well enough to please God. Only keeping God's laws perfectly can do that, and we are all law-breakers! Our only hope is by turning away from our sins and trusting in Jesus as our Savior. He is the only way we can please God. Ask Him to help you. He loves to answer this prayer!

Detective Dan's Lesson 2 Listening Assignment:**Our Bible Verse is Matthew 22:37-40:**

"You shall love the Lord your God with all your heart and with all your soul and with all your mind. This is the great and first commandment. And a second is like it: You shall love your neighbor as yourself. On these two commandments depend all the Law and the Prophets."

I need to find out:

1. Which laws did Jesus tell people to obey? God's laws.

2. Who is the only person to obey God's laws perfectly? How did He share His perfect life with us?

Jesus. He gave it up on the cross as the full payment for the sins of God's people when He suffered and died on the cross.

For You and Me

How amazing that Jesus kept God's laws perfectly! It's even more amazing that He offers to share His perfect life with us, that we might be saved! This is His promise to all who turn away from their sins and trust in Him as their Savior. Ask Him to help you do this! He loves to answer this prayer!

Detective Dan's Lesson 3 Listening Assignment:

Our six clues were: a pillow, a cup, two fish, a painter, a heart, and God's Ten, Big Laws.

1. Which four belong in our story?

The cup, the fish, the heart and God's Ten, Big Laws.

2. Who can help us keep God's laws and love others?

God's Holy Spirit, living in our hearts.

For You and Me:

Can God help us keep His laws and love others, too? Yes, He can! He will send His Holy Spirit to live inside all who turn away from their sins and trust in Jesus as their Savior. What a wonderful helper He is to have! He can come to live inside you and help you, too!

The Gospel (story wrap-up if NOT using Listening Assignments)**Our Bible Truth is:****What Are God's Laws Like?****God's Laws Are Perfect...****They Tell Us How to Love God and Others!**

God's laws tell us how to love God and others. But the sad news is that we all choose to not love God and others. We choose to disobey God and not love Him or others. We all deserve His punishment for our sins! God would have been perfectly fair to give us all the punishment we deserve for breaking His laws. He is holy and good. But God is so rich in mercy. He chose to give us something better than we deserve. He sent His Son Jesus to live a perfect life. Yes! Jesus kept every, single one of God's laws! And on the cross, He suffered and died, giving His perfect life as the full payment for the sins of all who turn away from their sins and trust in Him as their Savior. On the third day, Jesus rose from the dead. He had really beaten sin and death! Because of Jesus, all who trust in Him as their Savior get to enjoy wonderful, special closeness with God as His special people, even now. And one day, they will go to live with Him forever. We can be God's people when we turn from our sins and trust in Jesus. Ask Him to help you! He loves to do this!

Close in prayer.

Closing ACTS Prayer

- A** We praise You, God, for being the Giver of Your perfectly good laws that tell us how to love You and others.
- C** God, many times, we do not obey Your good laws. Many times, we do not love You or others as Your laws tell us to. We need a Savior!
- T** Thank You, God, for giving us Your good laws that show us how to love You and others. Thank You for sending Your Holy Spirit to live in our hearts when we trust in Jesus as our Savior. He helps us to obey Your good and loving laws.
- S** God, work in our hearts. Help us to turn away from our sins and trust in Jesus as our Savior. Send Your Holy Spirit to live inside our hearts and help us to love You and others as You want us to.

In Jesus' name we pray, Amen.

Go to Lesson Plan, p.9 for the script to the rest of the lesson.

BIG QUESTION 7



What are God's laws like?

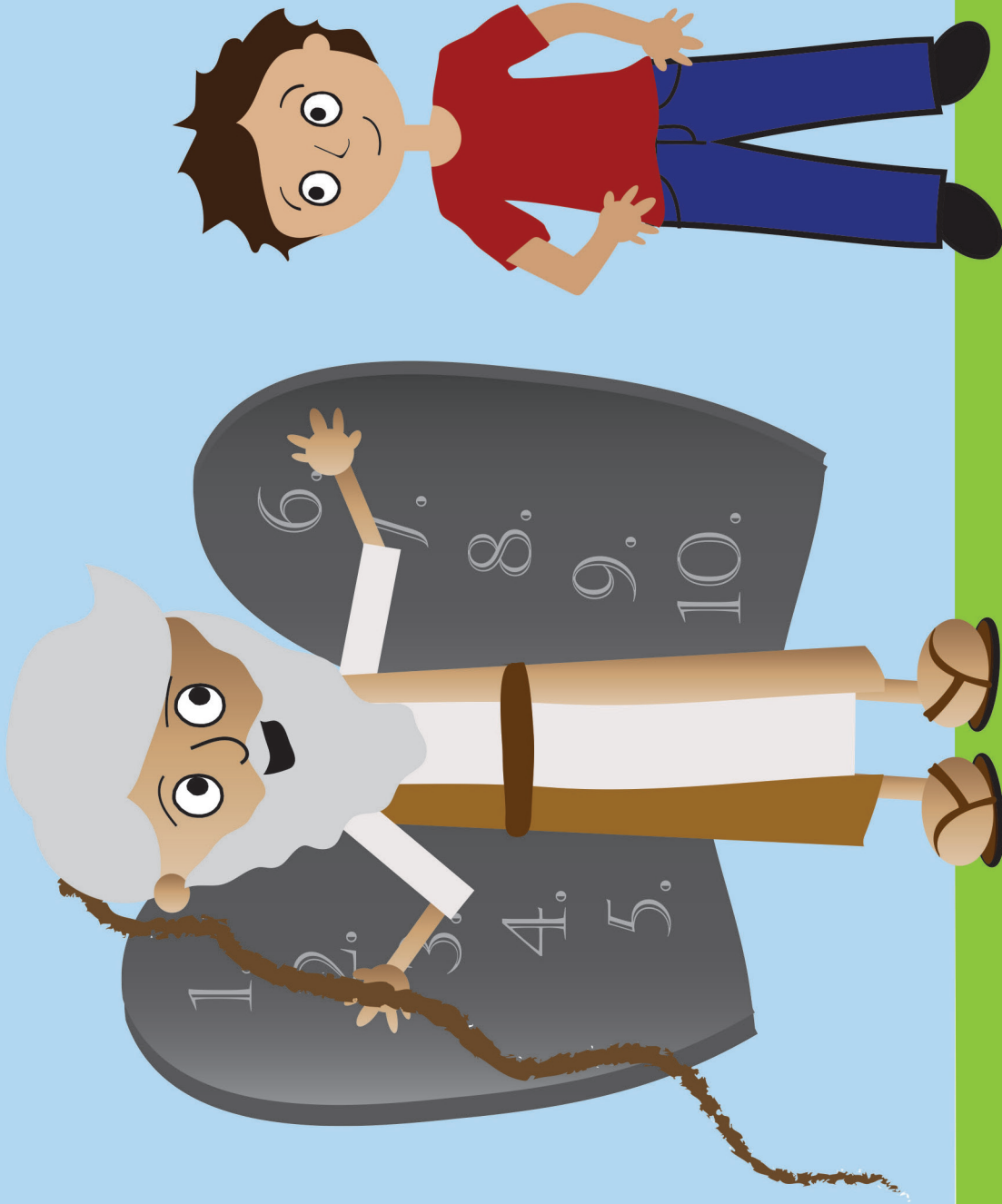

ANSWER:

God's laws are perfect!

VISUAL
AID

#1

take out



The Big Question

Hold up the Big Question sign for all the children to see, and say:

The Big Question we are investigating today is
Big Question Number 7:

What Are God's Laws Like?

and the Answer is:

God's Laws Are Perfect!

Meaning:

A law is a big rule made by someone in charge. God is our Maker. He is in charge of everyone in the whole world. He has given us His laws to live by.

God is good and loving, wise and fair. He is perfect! God's laws are just like Him. They are good and loving, wise and fair, too. They are perfect!

God's laws show us the very best way to live. They show us how to love God and love others. They are exactly what we need.

Let's sing our Big Question Song: "

Big Q & A 7 Song

DDD ESV Songs 7, track 12

(adapted version of "The Farmer in the Dell")

What are God's laws like?
What are God's laws like?
What are God's laws like?
God's laws are perfect!

BIG QUESTION 7: Three truths about God's laws

Visual Aid #2 of BQB take out

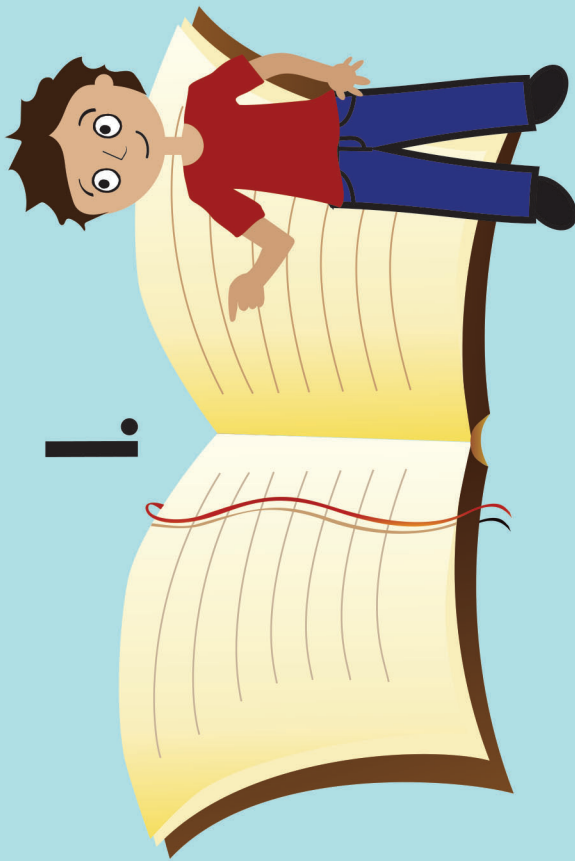

This Unit's Bible Truths

"God's laws are perfect is a good beginning, but there's so more to learn. So it's time for us to dig down even deeper for more answers to our Big Question about God. We're going to be learning THREE Bible truths that all tell us more about God's perfect laws.

Who would like to hand me the picture with our three Bible truths on it? It's in the Big Question Box/Briefcase."

Choose a child to get it and hand it to you, then hold it up and show them the pictures of the three truths they will be learning. After everyone has had a good look, say...

"Ok, we've learned two truths about God's laws. They are: "They Were Written in the Bible, God's Word" and, "They Show Us that We Need God to Save Us" (point to pictures as you identify each Bible Truth). Now let's look at our Bible Truth Clue sign and see if we can figure out which of these three truths we will be learning about today. Who would like to get it out of the Big Question Briefcase for me?"

Choose a child to open the briefcase, take out the Bible Truth Clue sign and hand it to you.

CAN YOU GUESS BIBLE TRUTH 3:

What are God's laws like?

God's laws are perfect...

they tell us how to
??? God and others!

**THE
LORD**

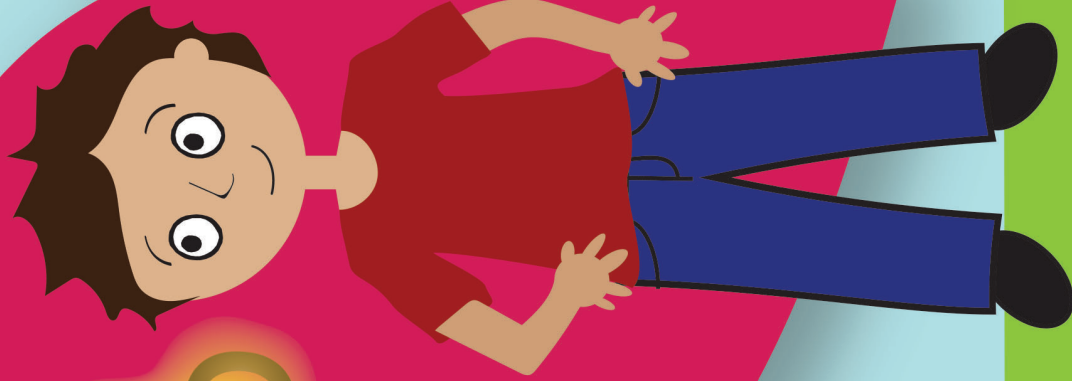

HINT: How does God want us to want
towards Himself and others? It starts
with an "L" and it rhymes with "dove."

ANSWER:

They tell us how to LOVE God and others!

Visual
Aid

#3



of BQB

take out

Revealing the Bible Truth We Are Learning

Hold up the front side for the children to see. Cover up the answer, written along the bottom, and say:

**“What Are God’s Laws Like?
God’s Laws Are Perfect!
They Tell Us How to ??? God and Others!”**

We’re missing one word. Here’s the hint to what the missing word is. It says: “How does God want us to feel and act towards Him and others? It starts with a “I” and it rhymes with “dove.”

Can you guess? It’s “love.”

So the Bible Truth we are learning today is:

(Uncover answer from bottom of sign, show it to them and say:)

**“What Are God’s Laws Like?
God’s Laws Are Perfect!
They Tell Us How to LOVE God and Others!”**

And here is what this Bible Truth means:

(read the meaning off of the back of the sign, say:)

The LORD is the one, true God. He deserves our love. He made us to love Him more than anything else. Loving God is the most delightful thing we can do. God gave us His laws so we can know how to love Him. When we obey His laws, we are living out our love for Him.

God made us not just to love Him, but also to love each other. He gave His laws so we can know how to love each other. He tells us to treat others in the same loving way we want others to treat us. When we obey God’s laws, we are living out God’s love for others. And, we are showing them a little bit of what God is like, that they might seek to know and love Him, too.

Obeying God’s laws is not just the right way to live. It is also the happiest way to live with God and with other people. God can help us obey His laws and live in love when we turn away from our sins and trust in Jesus as our Savior. He gives us a new heart filled with His Holy Spirit and helps us to live in love as He wants us to.



“You shall love the Lord your God with all your heart and with all your soul and with all your mind.

This is the great and first commandment.

And a second is like it: You shall love your neighbor as yourself.

On these two commandments depend all the Law and the Prophets.”

Matthew 22:37-40, ESV

Bible Truth 3 Bible Verse

Remove the Bible Verse Picture from the "Bible" folder and hold it up for all the children to see, then say:

Matthew 22:37-40 tells us:

Matthew 22:37-40, ESV

"You shall love the Lord your God with all your heart and with all your soul and with all your mind. This is the great and first commandment. And a second is like it: You shall love your neighbor as yourself. On these two commandments depend all the Law and the Prophets."

Learn a Little: "Love the Lord your God with all your heart, soul and mind... Love your neighbor as yourself."

What does that mean?

God has given us many laws in the Bible. It's good to know them all. But Jesus tells us in these verses that the purpose behind all of God's laws is to love God most of all, and to love others as we love ourselves. When we live out all His good laws, we are loving God and love others as He wants us to.

"We've said our Bible verse, now let's sing it!"

Love the Lord:

Matthew 22:37-40

DDD ESV Songs 7, track 27

Love the Lord your God with all your heart,
Love the Lord your God with all your soul,
Love the Lord your God with all your mind,
This is the first and greatest commandment.

And the second is like it...

Love your neighbor as yourself,
Love your neighbor as yourself,
Love your neighbor as yourself,
On these two commandments depend,
All the Law and Prophets.
Matthew Twenty-two,
Thirty-seven through forty.

"Now it's time to do a bit more deep down investigating. Let's see what Detective Dan wants us to help him figure out. Would someone like to get it out for me?"

take out



Place in



Visual Aid

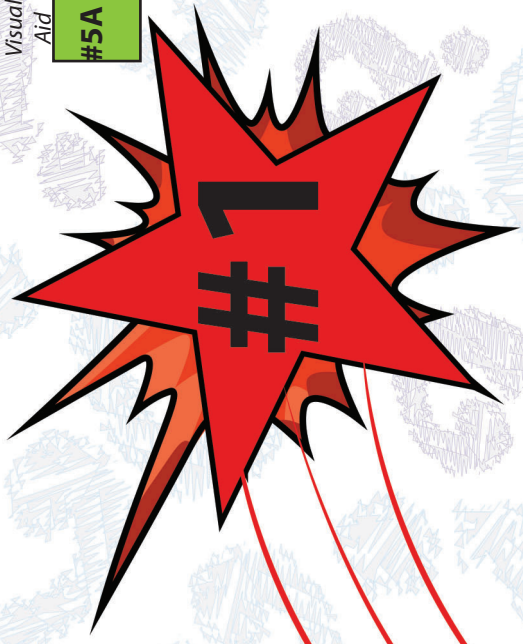

Detective Dan's Listening Assignment #1

Detective Dan's

Listening Assignment #1



Hi, Deep Down Detectives!

I'm working on a brand-new case called:

"The Case of the Do's and Don'ts."

I need to find out:

1. Who made up extra, little rules of do's and don'ts?
AND

2. What did Jesus think of those extra do's and don'ts?
What did Jesus say God's real laws help people to do?

Can you help me? Listen carefully to the story and you might just hear the answers!

Thanks!

Detective Dan

Then say, "Ok, Deep Down Detectives! Put on your best listening ears and see if you can hear the answers to Detective Dan's questions. When I finish telling the story, we will see if we can answer all of his questions."

Read the Bible Truth story, putting up the storyboard pictures as you tell it.

At the end of the story, repeat the questions and lead the children in answering them. Present the gospel and close in prayer.

Answers to assignment questions, the gospel and ACTS prayer are also included at the end of the story text.

Answers:

1. Who made up extra, little rules of do's and don'ts? The Pharisees.
2. What did Jesus think of those extra do's and don'ts? What did Jesus say God's real laws help people to do? Jesus knew those do's and don'ts weren't what pleased God. Jesus said God's real laws help people love God most of all and love others.

For You and Me

None of us can ever obey God's laws well enough to please God. Only keeping God's laws perfectly can do that, and we are all law-breakers! Our only hope is by turning away from our sins and trusting in Jesus as our Savior. He is the only way we can please God. Ask Him to help you. He loves to answer this prayer!

take out



Place in



Visual Aid



Detective Dan's Listening Assignment #2

Detective Dan's

Listening Assignment #2



Hi, Deep Down Detectives!

I'm still working on the case called:

"The Case of the Do's and Don'ts."

Our Bible Verse is **Matthew 22:37-40, ESV:**

"You shall love the Lord your God with all your heart and with all your soul and with all your mind. This is the great and first commandment. And a second is like it: You shall love your neighbor as yourself. On these two commandments depend all the Law and the Prophets."

I need to find out:

1. Which laws did Jesus tell people to obey?

AND

2. Who is the only person to obey God's laws perfectly?

How did He share His perfect life with us?

Can you help me? Listen carefully to the story and you might just hear the answers!

Thanks for your help!

Detective Dan

Then say, "Ok, Deep Down Detectives! Put on your best listening ears and see if you can hear the answers to Detective Dan's questions. When I finish telling the story, we will see if we can answer all of his questions."

Read the Bible Truth story, putting up the storyboard pictures as you tell it. At the end of the story, repeat the questions and lead the children in answering them. Present the gospel and close in prayer.

Answers to assignment questions, the gospel and ACTS prayer are also included at the end of the story text.

Answers:

Our Bible Verse is Matthew 22:37-40, ESV

"You shall love the Lord your God with all your heart and with all your soul and with all your mind. This is the great and first commandment. And a second is like it: You shall love your neighbor as yourself. On these two commandments depend all the Law and the Prophets."

I need to find out:

1. Which laws did Jesus tell people to obey? God's laws.

2. Who is the only person to obey God's laws perfectly? How did He share His perfect life with us?

Jesus. He gave it up on the cross as the full payment for the sins of God's people when He suffered and died on the cross.

For You and Me:

How amazing that Jesus kept God's laws perfectly! It's even more amazing that He offers to share His perfect life with us, that we might be saved! This is His promise to all who turn away from their sins and trust in Him as their Savior. Ask Him to help you do this! He loves to answer this prayer!

take out



Place in



Visual Aid



Detective Dan's Listening Assignment #3

Detective Dan's

Listening Assignment #3



Hi, Deep Down Detectives!

I'm still working on the case called:

"The Case of the Do's and Don'ts."

I found SIX clues, but TWO of them are NOT in the story. They are: a pillow, a cup, two fish, a painter, a heart, and God's Ten, Big Laws.

Hold up each of the six pictures for the children to see as you identify them. Better yet, put them up on your flannelgraph board, off to one side.

I need to know:

1. Which FOUR pictures belong in the story and which TWO do NOT?
2. Who can help us keep God's laws and love others?

Can you help me? Listen carefully to the story and you might just hear the answers!

Thanks!

Detective Dan

Then say, "Ok, Deep Down Detectives! Put on your best listening ears and see if you can hear the answers to Detective Dan's questions. When I finish telling the story, we will see if we can answer all of his questions."

Read the Bible Truth story, putting up the storyboard pictures as you tell it. At the end of the story, repeat the questions and lead the children in answering them. Present the gospel and close in prayer.

Answers to assignment questions, the gospel and ACTS prayer are also included at the end of the story text.

Answers:

1. **Which four belong in our story?**
The cup, the fish, the heart and God's Ten, Big Laws. The painter and the pillow do not.
2. **Who can help us keep God's laws and love others?** God's Holy Spirit, living in our hearts.

For You and Me:

Can God help us keep His laws and love others, too? Yes, He can! He will send His Holy Spirit to live inside all who turn away from their sins and trust in Jesus as their Savior. What a wonderful helper He is to have! He can come to live inside you and help you, too!

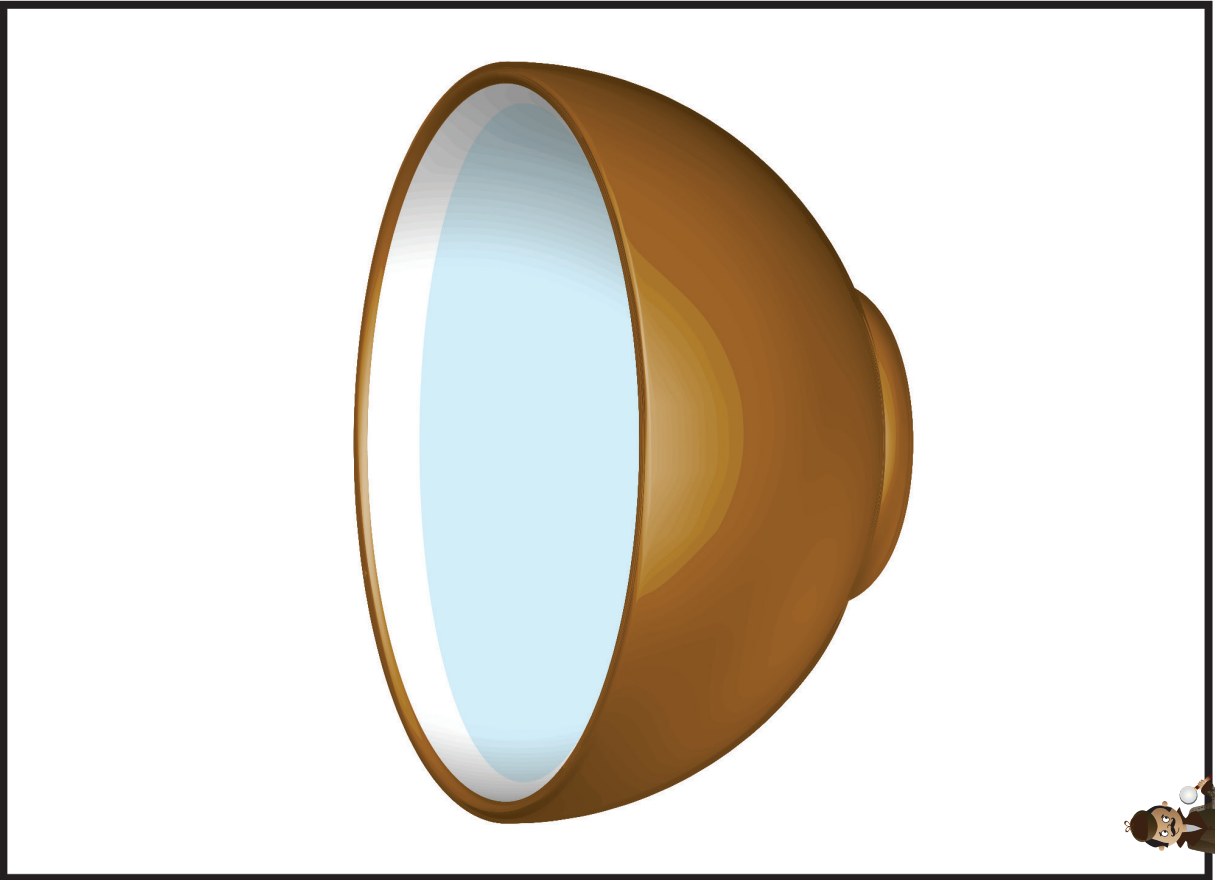

A Cup

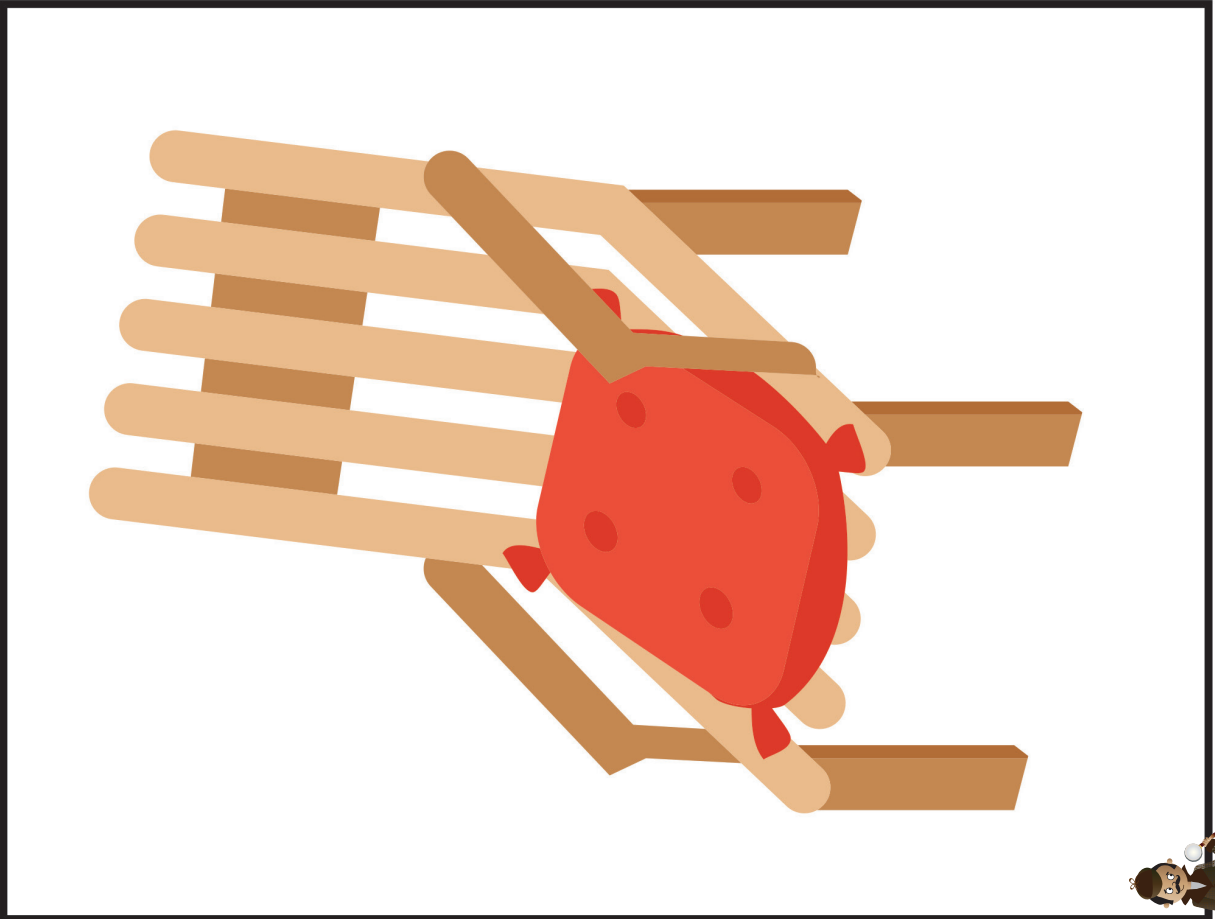

A Pillow

VISUAL
AID
#5C

Place in
DDD
Bible™

take out
Big
Question
Briefcase
of BQB

VISUAL
AID
#5C

Place in
DDD
Bible™

take out
Big
Question
Briefcase
of BQB

DDD 7.3 Lesson 3 Listening Assignment Clue Picture 2 for kids

DDD 7.3 Lesson 3 Listening Assignment Clue Picture 1 for kids

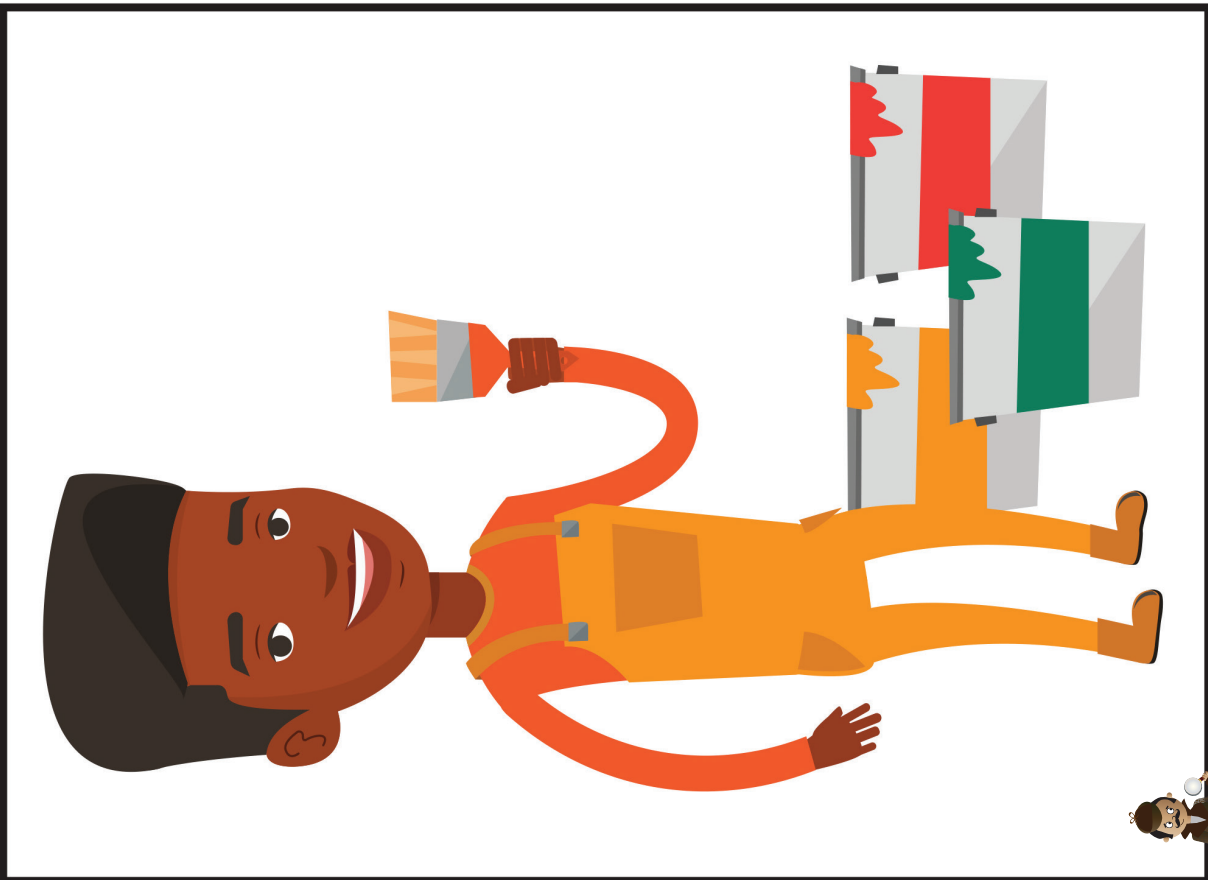

A Painter

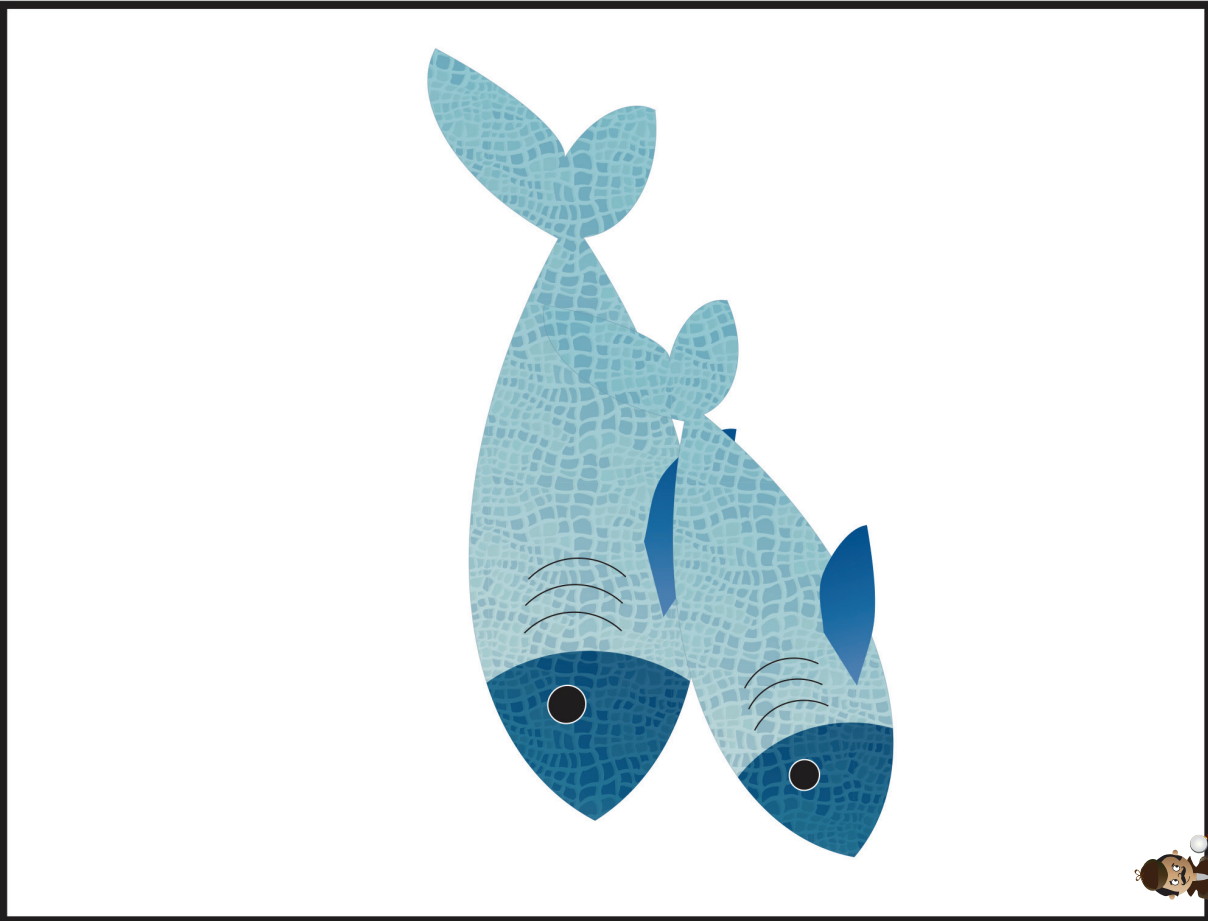

Two Fish

VISUAL
AID
#5C

Place in
DDD
Bible™

take out
Big
Question
Briefcase
of BQB

VISUAL
AID
#5C

Place in
DDD
Bible™

take out
Big
Question
Briefcase
of BQB

DDD 7.3 Lesson 3 Listening Assignment Clue Picture 4 for kids

DDD 7.3 Lesson 3 Listening Assignment Clue Picture 3 for kids

God's Ten, Big Laws

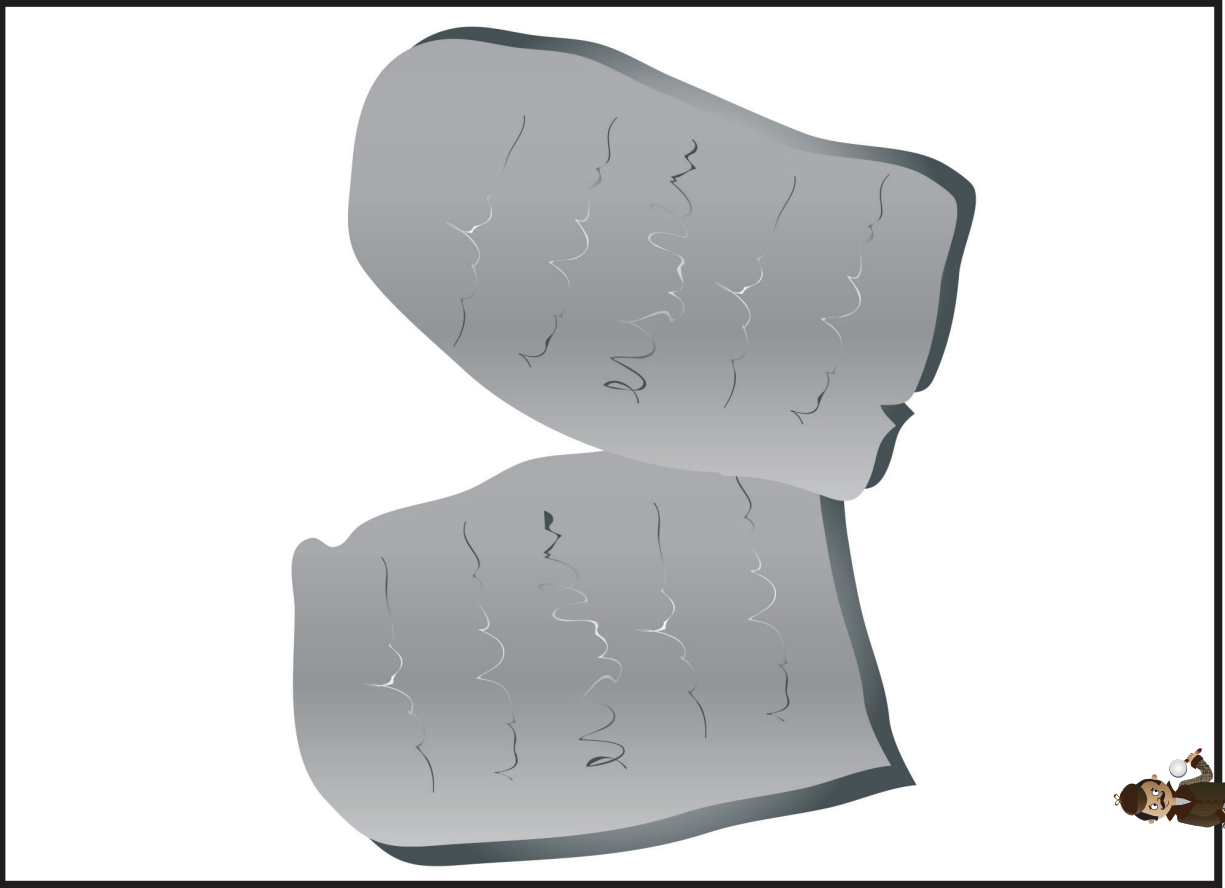

A Heart

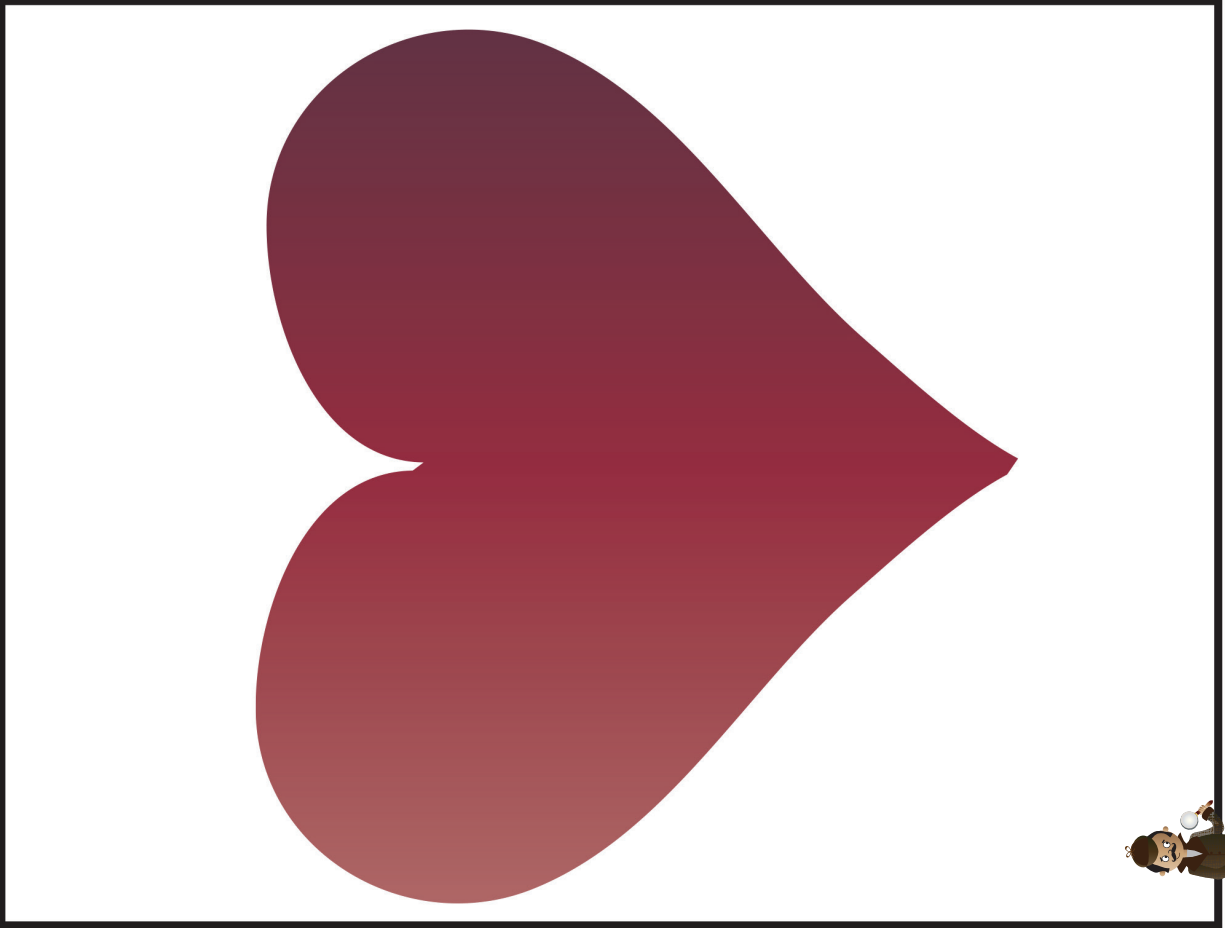

VISUAL
AID
#5C

Place in
DDD
Bible™

take out
Big
Question
Briefcase
of BQB

VISUAL
AID
#5C

Place in
DDD
Bible™

take out
Big
Question
Briefcase
of BQB

DDD 7.3 Lesson 3 Listening Assignment Clue Picture 6 for kids

DDD 7.13 Lesson 3 Listening Assignment Clue Picture 5 for

“The Case of the Do’s and Don’ts” Matthew 5,6,22

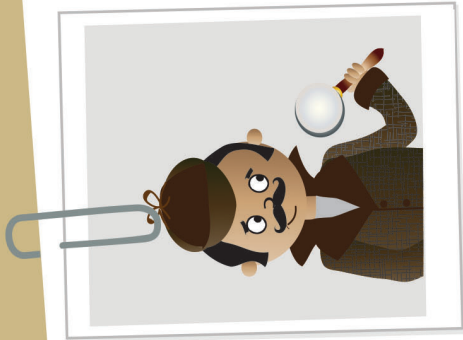

Detective Dan's Listening Assignment #1

1. Who made up extra, little rules of do's and don'ts?
2. What did Jesus think of those extra do's and don'ts?
What did Jesus say God's real laws help people to do?



Detective Dan's Listening Assignment #2

Matthew 22:37,39, ESV

“Love the Lord your God with all your heart, soul and mind... Love your neighbor as yourself.”

1. Which laws did Jesus tell people to obey?
2. Who is the only person to obey God's laws perfectly?
How did He share His perfect life with us?

(more listening and discussion questions are included in the curriculum at praisefactory.org)

I. Rules! Rules! Rules! So many rules for God's people to keep! "Do this! Don't do that!" the teachers in Jesus' day (the Pharisees) taught the people.

Of course, there were the Ten, Big Laws (the Ten Commandments) that God had given them through Moses. But there were so many more rules than that.

Can you guess how many laws the Pharisees counted in God's Word for everyone to obey? Twenty? Fifty? Surely, not a hundred!



I. Rules! Rules! Rules! So many rules for God's people to keep! "Do this! Don't do that!" the teachers in Jesus' day (the Pharisees) taught the people. Of course, there were the Ten, Big Laws (the Ten Commandments) that God had given them through Moses. But there were so many more rules than that. Can you guess how many laws the Pharisees counted in God's Word for everyone to obey? Twenty? Fifty? Surely, not a hundred!

2. It was more than any of those guesses! It was 613! There were 248 “DO” laws and 365 “DON’T” laws.

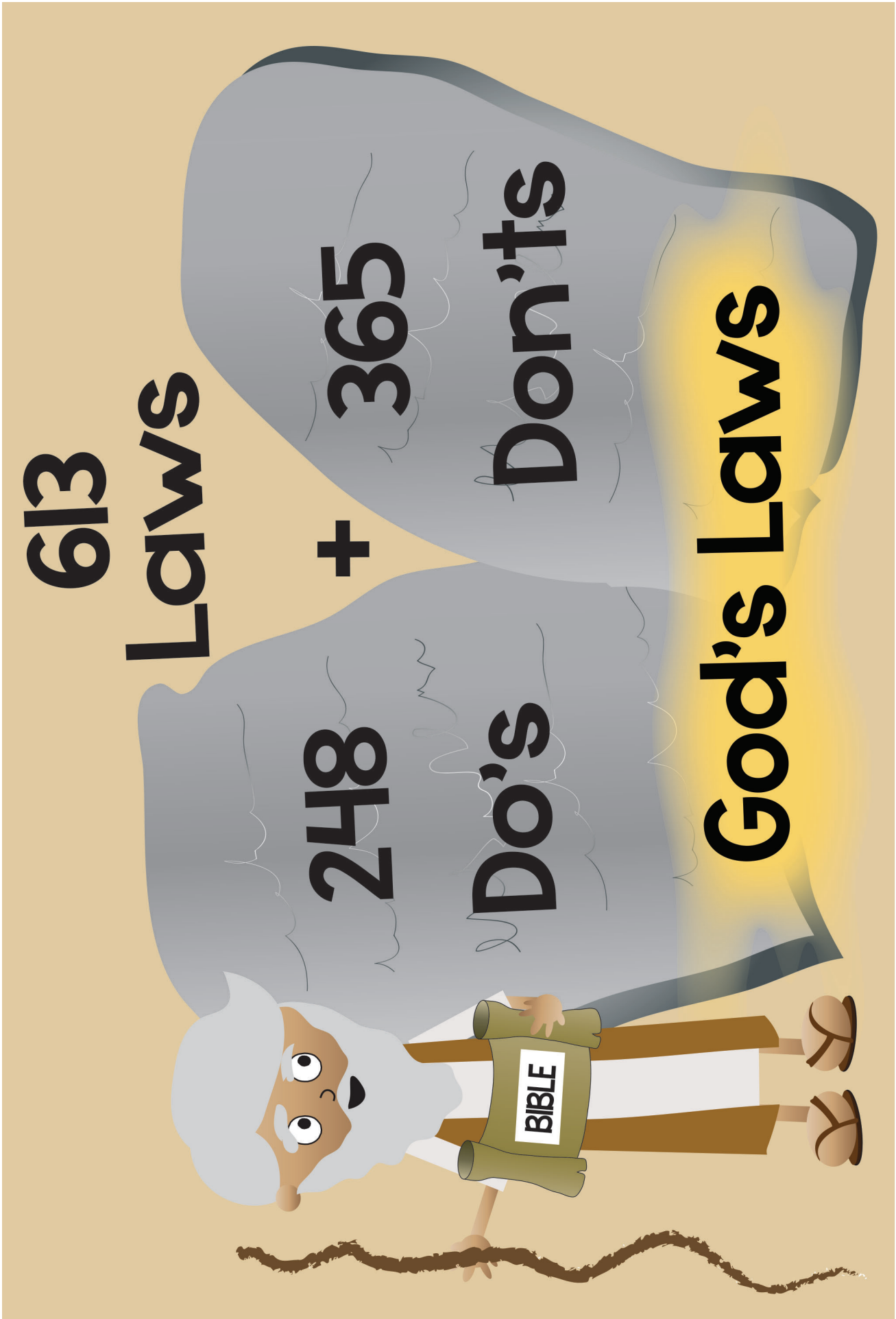

2. It was more than any of those guesses! It was 613! There were 248 "DO" laws and 365 "DON'T" laws.

3. But soon, those 613 laws turned into even more, as the teachers came up with extra ways they wanted God's people to live them out.

They came up with extra "DO's" like: "DO say a special prayer as you wash your hands when you wake up in the morning, or you won't please God." And extra DON'T's" like: "DON'T use the same spoon to stir milk and cook meat, or you won't please God."

What a lot of extra rules! Oh, how they weighed down the people! Who could keep all these rules!



3. But soon, those 613 laws turned into even more, as the teachers came up with extra ways they wanted God's people to live them out. They came up with extra "DO's" like: "DO say a special prayer as you wash your hands when you wake up in the morning, or you won't please God." And extra DON'T's" like: "DON'T use the same spoon to stir milk and cook meat, or you won't please God." What a lot of extra rules! Oh, how they weighed down the people! Who could keep all these rules!

4. But then, Jesus came. He wasn't like any of the other teachers. He healed sick people without using any medicine! He brought dead people back to life again! He even forgave people's sins! Jesus simply spoke and God's power did these wonderful things through Him.

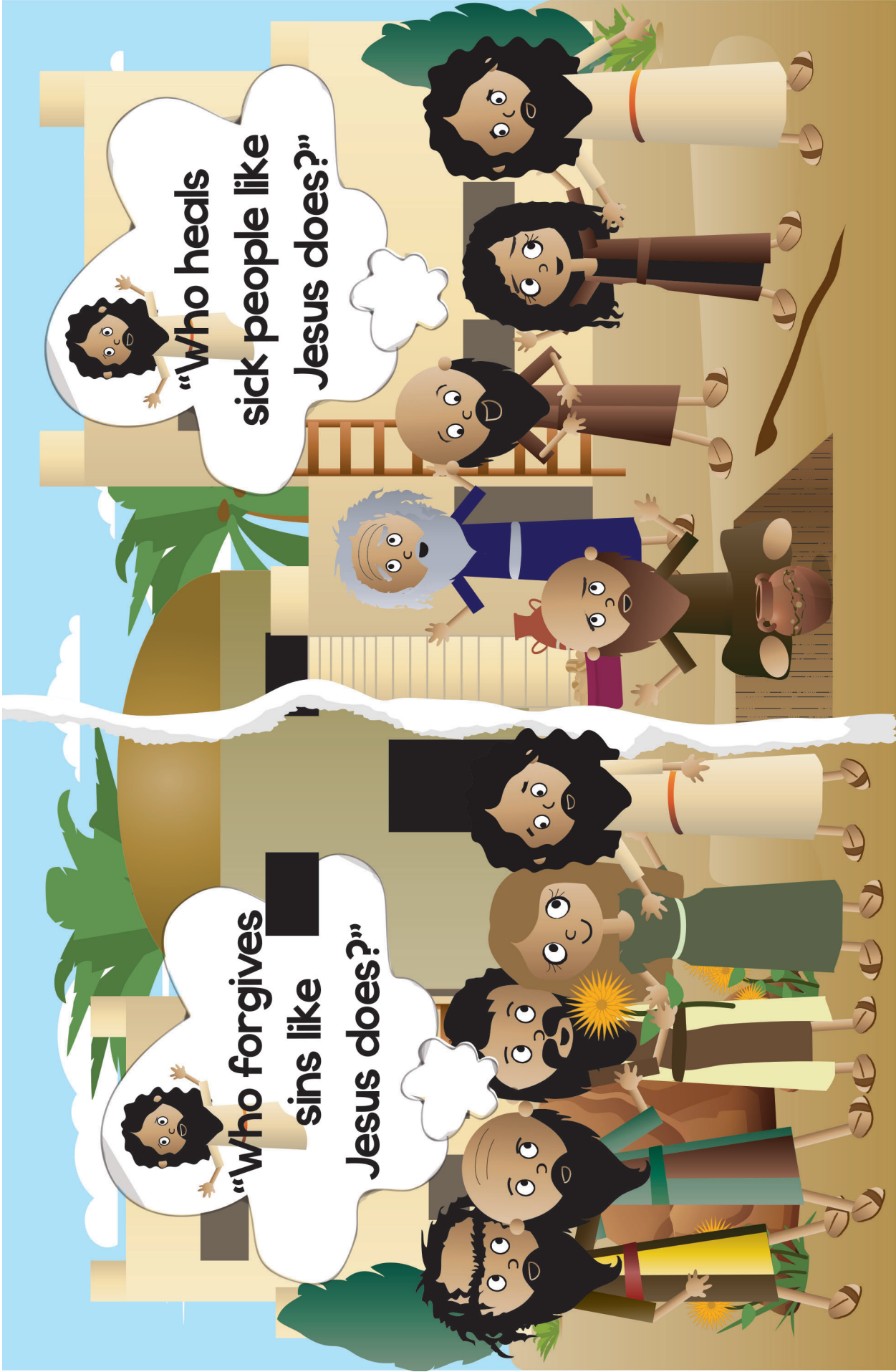

4. But then, Jesus came. He wasn't like any of the other teachers. He healed sick people without using any medicine! He brought dead people back to life again! He even forgave people's sins! Jesus simply spoke and God's power did these wonderful things through Him.

5. Jesus did other amazing things, too.

One time, Jesus said, “Be still,” to the strong winds and the big waves of a huge storm. Right away, the storm stopped. Another time, Jesus fed a huge, hungry crowd of people with just two fish and five loaves of bread. Wow!



5. Jesus did other amazing things, too. One time, Jesus said, “Be still,” to the strong winds and the big waves of a huge storm. Right away, the storm stopped. Another time, Jesus fed a huge, hungry crowd of people with just two fish and five loaves of bread. Wow!

6. The news about Jesus spread quickly. Soon, many people were coming to Jesus.

They came to have Him heal their sick family and friends. They came to see Him do amazing things. And, they came to hear what He had to say about God and His laws.

Would Jesus be like all the other teachers? Would He tell them to keep all those Do's and Don'ts? Would He give them lots of extra rules like the Pharisees did?

Jesus answered all of their questions.



6. The news about Jesus spread quickly. Soon, many people were coming to Jesus. They came to have Him heal their sick family and friends. They came to see Him do amazing things. And, they came to hear what He had to say about God and His laws. Would Jesus be like all the other teachers? Would He tell them to keep all those Do's and Don'ts? Would He give them lots of extra rules like the Pharisees did? Jesus answered all of their questions.

7. One day, Jesus and a huge crowd of people climbed up, up, up, up a grassy mountain above the Sea of Galilee. When they reached the top, Jesus sat down and began to teach them about God's laws.

“God's laws are very important,” Jesus told the people. “God's laws will last until the end of time. I have not come to get rid of even one of God's good laws,” He said.



7. One day, Jesus and a huge crowd of people climbed up, up, up a grassy mountain above the Sea of Galilee. When they reached the top, Jesus sat down and began to teach them about God's laws. "God's laws are very important," Jesus told the people. "God's laws will last until the end of time. I have not come to get rid of even one of God's good laws," He said.

8. “Your teachers, the Pharisees, try to please God by adding lots of extra, little rules to God’s good laws. They think all this rule-keeping will make them right with God, but it’s not enough. You need something more than all their extra, little rules to please God. You will need a better righteousness than theirs, if you want to be God’s people,” Jesus told them.



8. “Your teachers, the Pharisees, try to please God by adding lots of extra, little rules to God’s good laws. They think all this rule-keeping will make them right with God, but it’s not enough. You need something more than all their extra, little rules to please God. You will need a better righteousness than theirs, if you want to be God’s people,” Jesus told them.

q. Oh, no! This didn't sound good at all! The Pharisees worked so hard to keep all 613 laws in the Bible! And, they made up all those hundreds of extra, little rules, to try to please God, too.

How could ANYONE be better than the Pharisees? Was Jesus going to give them even MORE rules to live by? It sure sounded that way.



q. Oh, no! This didn't sound good at all! The Pharisees worked so hard to keep all 613 laws in the Bible! And, they made up all those hundreds of extra, little rules, to try to please God, too. How could ANYONE be better than the Pharisees? Was Jesus going to give them even MORE rules to live by? It sure sounded that way.

10. No, Jesus was not. “Your teachers are wrong about their extra, little rules. They just weigh down people. They don’t help anyone live as God wants them to live,” Jesus said.

“I have come to fulfill God’s law. I will teach you how to really live out God’s laws to please Him,” He told the crowds. “The “Do’s” and “Don’ts” in God’s Word are all about how we show love to God and others. These laws start in the heart with love, and they tell us how God wants us to live out that love with our whole lives,” Jesus explained.



10. No, Jesus was not. “Your teachers are wrong about their extra, little rules. They just weigh down people. They don’t help anyone live as God wants them to live,” Jesus said. “I have come to fulfill God’s law. I will teach you how to really live out God’s laws to please Him,” He told the crowds. “The “Do’s” and “Don’ts” in God’s Word are all about how we show love to God and others. These laws start in the heart with love, and they tell us how God wants us to live out that love with our whole lives,” Jesus explained.

11. “Some people LOOK like they obey God’s laws, but really, they are still breaking them,” Jesus told the people. “They do the right thing on the outside, but in their hearts, they are angry or jealous or hateful.”

“God doesn’t just look on the outside. He sees inside every heart. He knows the sin that is hiding there. He knows when you are angry or jealous or hateful. What goes on inside your heart breaks God’s laws, too,” Jesus explained.



II. “Some people LOOK like they obey God’s laws, but really, they are still breaking them,” Jesus told the people. “They do the right thing on the outside, but in their hearts, they are angry or jealous or hateful. God doesn’t just look on the outside. He sees inside every heart. He knows the sin that is hiding there. He knows when you are angry or jealous or hateful. What goes on inside your heart breaks God’s laws, too,” Jesus explained.

12. The people listened to Jesus and were amazed! Jesus wasn't at all like the other teachers they had heard before. He didn't just give them lots of extra, little rules. He helped them see that God's laws show them how to truly love God and others.



12. The people listened to Jesus and were amazed! Jesus wasn't at all like the other teachers they had heard before. He didn't just give them lots of extra, little rules. He helped them see that God's laws show them how to truly love God and others.

13. As Jesus later said: “Love the LORD with all your heart, your mind, and your strength. Love others --even your enemies-- as much as you love yourself. Do to them only what you want them to do to you. If you do love the LORD and love others like this, you will be obeying all of God’s laws, because that’s what God’s laws are really all about.”

How about that! All of those 10 Commandments, and even all of those 613 laws, really added up to only two: love the LORD and love others. Amazing!

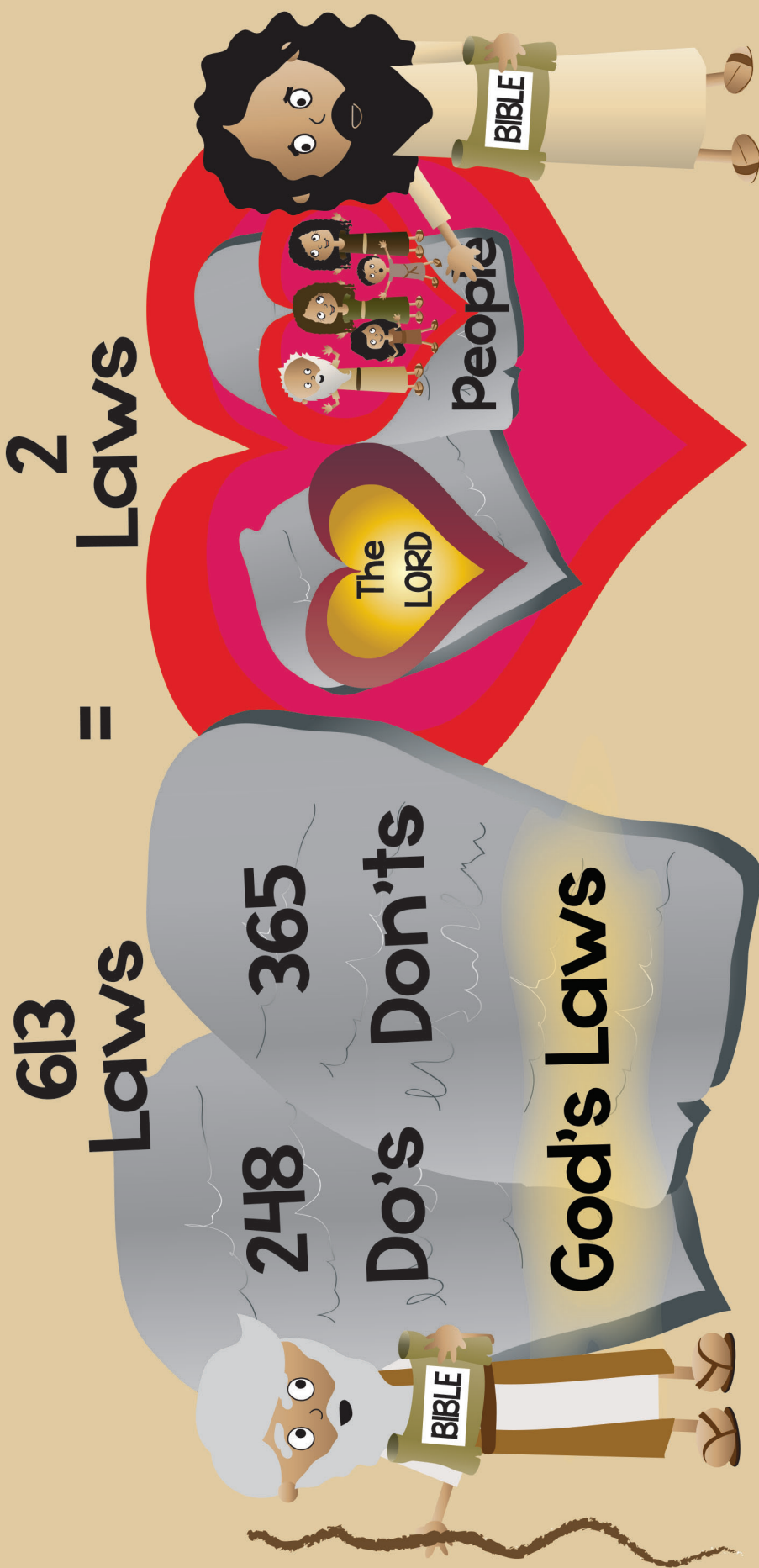

13. As Jesus later said: "Love the LORD with all your heart, your mind, and your strength. Love others --even your enemies-- as much as you love yourself. Do to them only what you want them to do to you. If you do love the LORD and love others like this, you will be obeying all of God's laws, because that's what God's laws are really all about."

How about that! All of those 10 Commandments, and even all of those 613 laws, really added up to only two: love the LORD and love others. Amazing!

14. I wonder what people were thinking as climbed down the mountain at the end of the day. Jesus had given them less rules to follow, but they were much harder than all those 613 “Do’s” and “Don’ts” in God’s Word, and all those extra, little rules of the Pharisees.

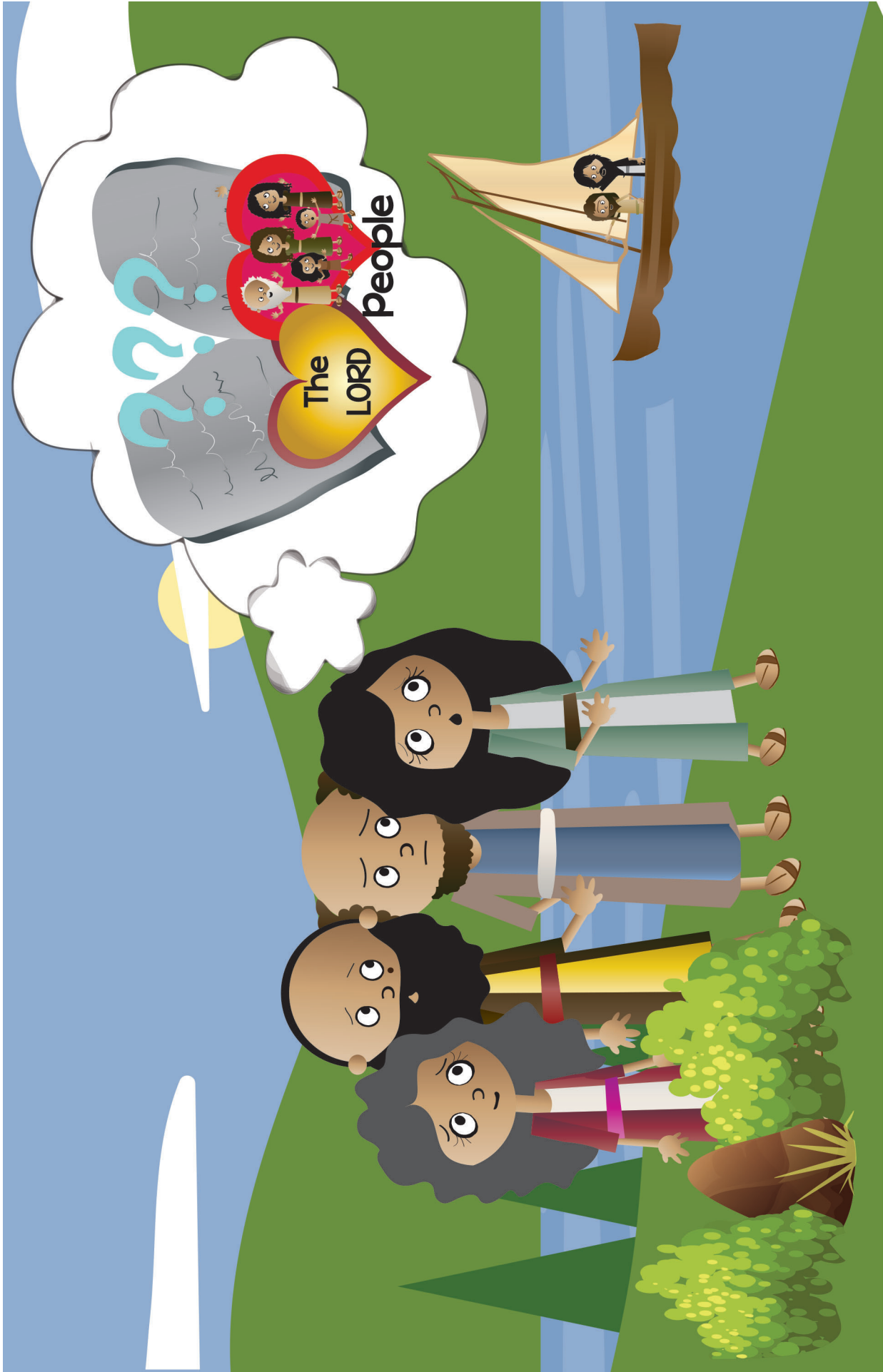

14. I wonder what people were thinking as climbed down the mountain at the end of the day. Jesus had given them less rules to follow, but they were much harder than all those 613 “Do’s” and “Don’ts” in God’s Word, and all those extra, little rules of the Pharisees.

15. Anyone could remember to wash their hands when they woke up in the morning, or to use a different spoon when they stirred the milk and cooked the meat.

But loving God and others from the heart... that was so hard! How could they ever keep their hearts from being angry or jealous or hateful towards others? How could they really love God most of all? Could they ever really obey God's laws? Could they ever please God and love God's people, if this was how they must live? There seemed to be no hope.

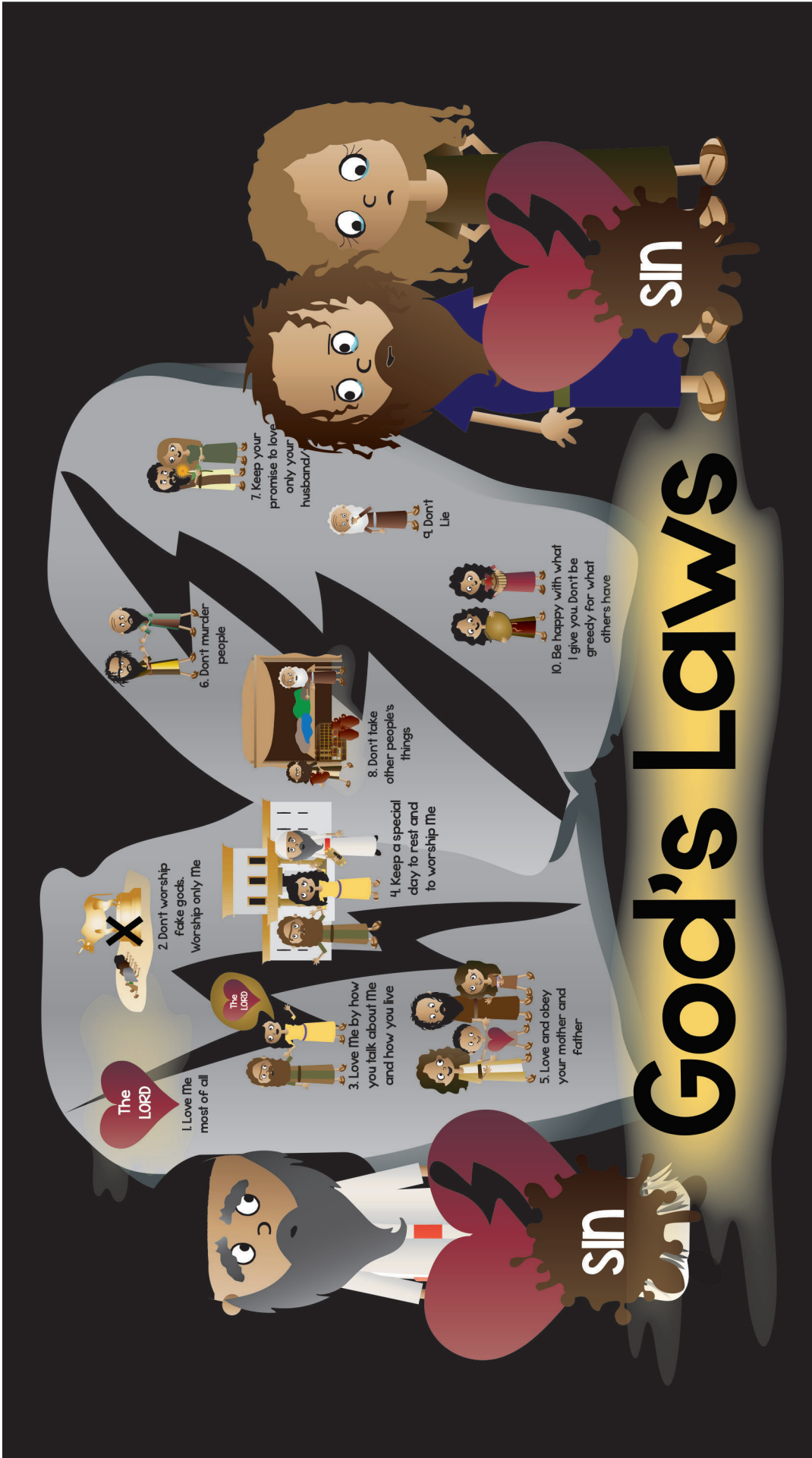

15. Anyone could remember to wash their hands when they woke up in the morning, or to use a different spoon when they stirred the milk and cooked the meat. But loving God and others from the heart... that was so hard! How could they ever keep their hearts from being angry or jealous or hateful towards others? How could they really love God most of all? Could they ever really obey God's laws? Could they ever please God and love God's people, if this was how they must live? There seemed to be no hope.

16. Well, there WAS no hope, if they had to obey God's good laws of love on their own.

But praise God, they did NOT! That's why God sent Jesus! Not just to TELL the people what it really means to live out God's laws. But, to DO it, HIMSELF!

Yes, Jesus lived out God's laws perfectly every day He lived here on earth. He always loved God most of all. He always loved people. In everything He thought, and said, and did, Jesus fulfilled God's law completely. He pleased God with His whole life. Jesus could do this because He was the perfect Son of God. He truly loved God, His Father, and He had come to be our Savior.

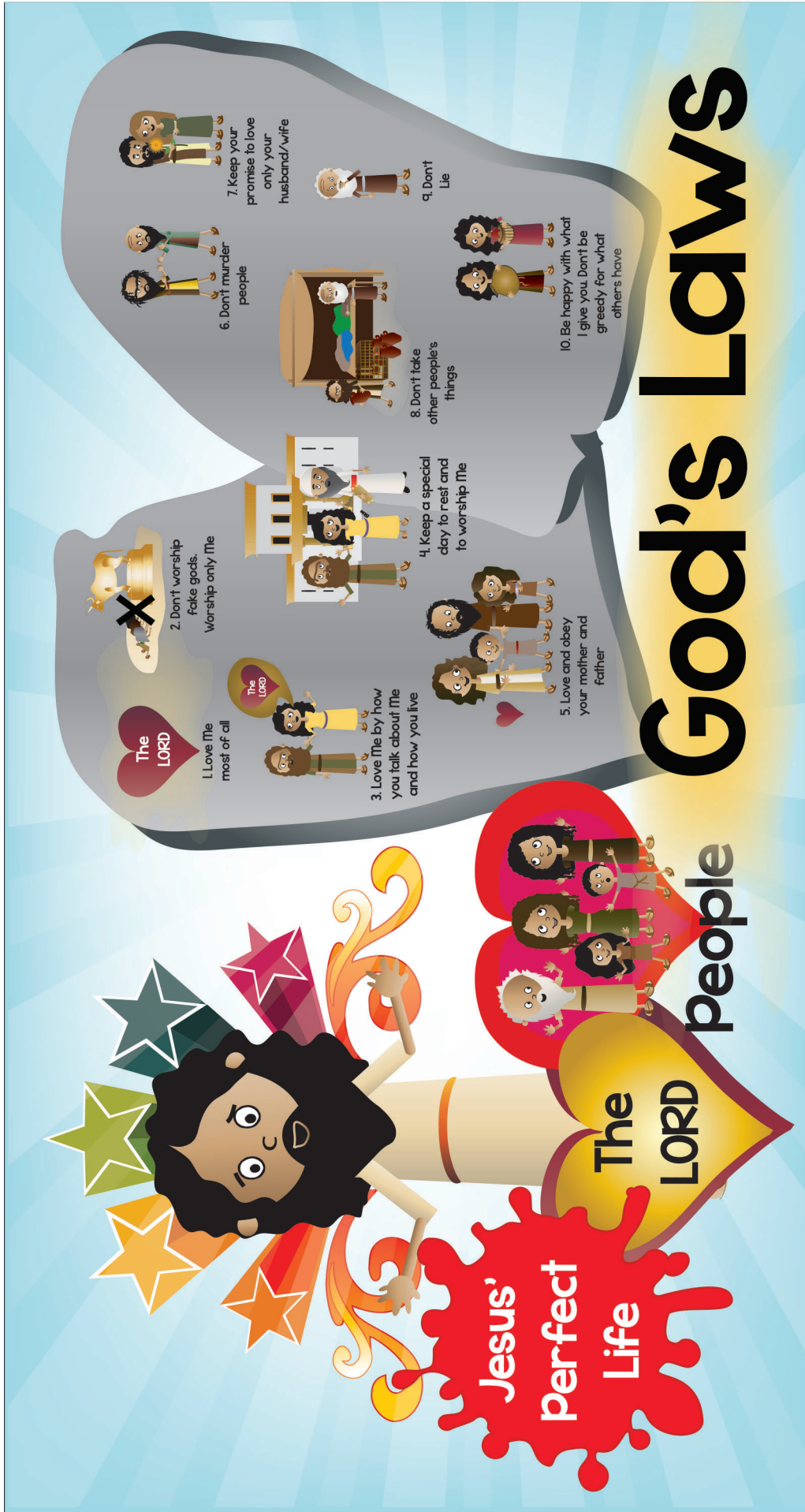

16. Well, there **WAS** no hope, if they had to obey God's good laws of love on their own. But praise God, they did **NOT!** That's **why** God sent Jesus! Not just to **TELL** the people what it really means to live out God's laws. But, to **DO** it, **HIMSELF!** Yes, Jesus lived out God's laws perfectly every day He lived here on earth. He always loved God most of all. He always loved people. In everything He thought, and said, and did, Jesus fulfilled God's law completely. He pleased God with His whole life. Jesus could do this because He was the perfect Son of God. He truly loved God, His Father, and He had come to be our Savior.

17. And what did the Pharisees think about what Jesus taught? They did NOT like it! They did not like that Jesus said He was God's Son. They did not like what He said about them and all their extra, little rules. And so, the Pharisees and other enemies worked together to get rid of Jesus. They nailed Him to a cross to suffer and die, and to get rid of Him, once and for all.

But God was up to good, even in the bad plans of Jesus' enemies. For on that cross, Jesus offered up His perfect life as the full payment for the sins of all who would ever turn away from their sins and trust in Him as their Savior. He took their punishment and gave them His perfect life. Now, they could please God. Not with their own lives, but with His!



17. And what did the Pharisees think about what Jesus taught? They did NOT like it! They did not like that Jesus said He was God's Son. They did not like what He said about them and all their extra, little rules. And so, the Pharisees and other enemies worked together to get rid of Jesus. They nailed Him to a cross to suffer and die, and to get rid of Him, once and for all.

But God was up to good, even in the bad plans of Jesus' enemies. For on that cross, Jesus offered up His perfect life as the full payment for the sins of all who would ever turn away from their sins and trust in Him as their Savior. He took their punishment and gave them His perfect life. Now, they could please God. Not with their own lives, but with His!

18. Jesus died and was buried in a cave-grave that sad day, but did He stay there? No, He did not! On the third day, He rose from the dead. Jesus had really beaten sin and death for God's people!

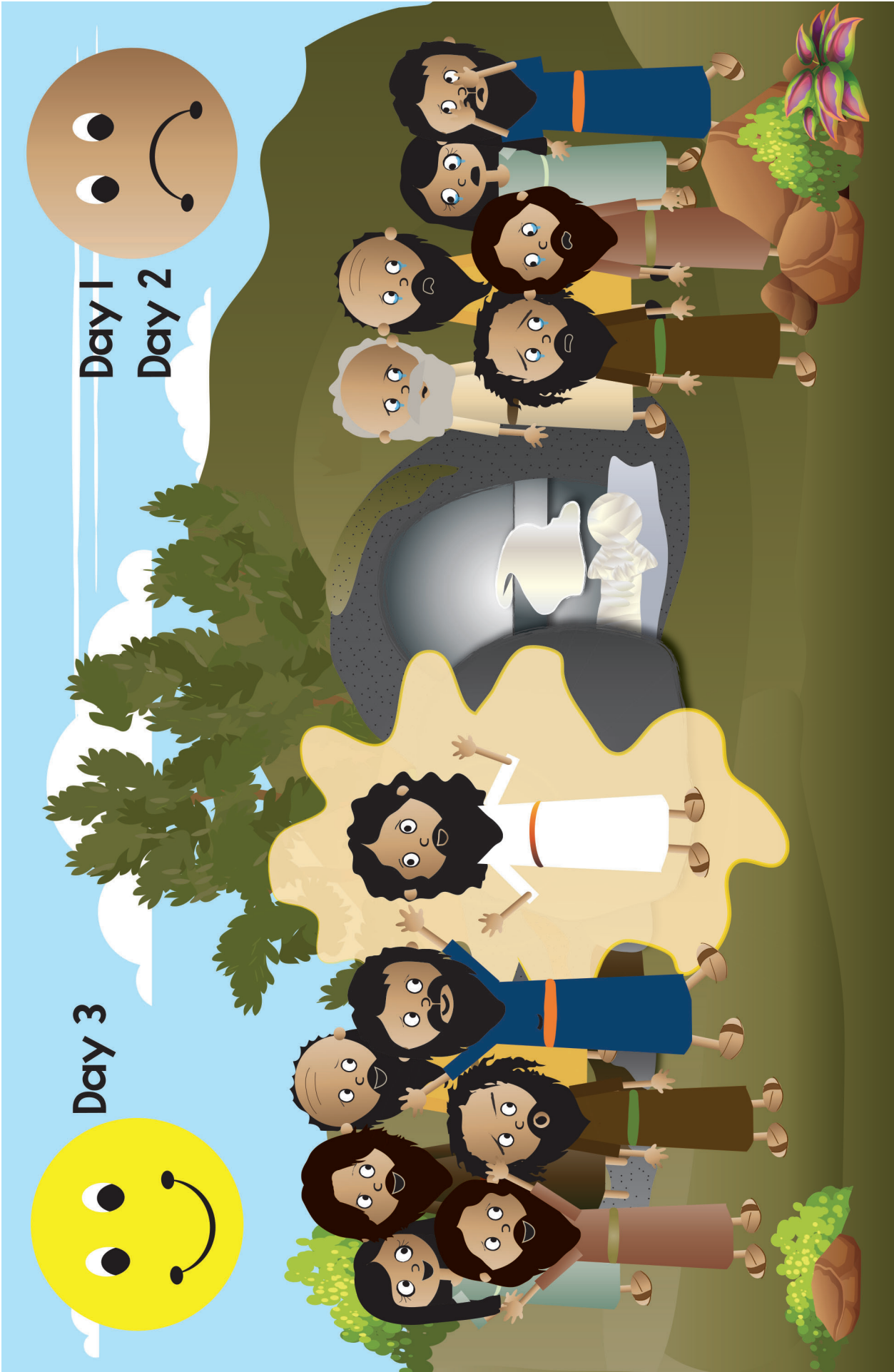

18. Jesus died and was buried in a cave-grave that sad day, but did He stay there? No, He did not! On the third day, He rose from the dead. Jesus had really beaten sin and death for God's people!

19. After Jesus rose from the dead, He appeared to His followers and taught them more about God's good plans. Best of all, He told them about God's special gift to help them live out God's law from their hearts. Do you know what that special gift was?



19. After Jesus rose from the dead, He appeared to His followers and taught them more about God's good plans. Best of all, He told them about God's special gift to help them live out God's law from their hearts. Do you know what that special gift was?

20. It was the Holy Spirit!

“I am going back home to heaven, but I will send you the Holy Spirit to live in your hearts,” Jesus told His followers. “He will fill your hearts with love. He will help you love God most of all. He will help you love others, too. And He will stay with you your whole lives until the day you come home to live with Me forever,” Jesus promised them.



20. It was the Holy Spirit! "I am going back home to heaven, but I will send you the Holy Spirit to live in your hearts," Jesus told His followers. "He will fill your hearts with love. He will help you love God most of all. He will help you love others, too. And He will stay with you your whole lives until the day you come home to live with Me forever." Jesus promised them.

21. And sure enough, not long after Jesus went up to heaven, He did send the Holy Spirit to live in the hearts of God's people! How they praised God! How happy they were! God had been so good to them through Jesus.

Jesus had lived a perfect life of love and given it to them, so they could be God's people. He had sent the Holy Spirit to live inside their hearts for the rest of their lives. He would change their hearts and help them to obey God's laws and love God and others.



21. And sure enough, not long after Jesus went up to heaven, He did send the Holy Spirit to live in the hearts of God's people! How they praised God! How happy they were! God had been so good to them through Jesus. Jesus had lived a perfect life of love and given it to them, so they could be God's people. He had sent the Holy Spirit to live inside their hearts for the rest of their lives. He would change their hearts and help them to obey God's laws and love God and others.

22. And, how God's people looked forward to the day when they will go to live with God forever! Then, God will make all things new, even their hearts. Then, they will love God and each other perfectly.

And at last, God's laws will be perfectly fulfilled, even in them! We can become God's people, too, when we turn away from our sins and trust in Jesus as our Savior.



22. And, how God's people looked forward to the day when they would go to live with God forever! Then, God will make all things new, even their hearts. Then, they will love God and each other perfectly. And at last, God's laws will be perfectly fulfilled, even in them! We can become God's people, too, when we turn away from our sins and trust in Jesus as our Savior.

DDD 7.3 Simple Story Scenes

“The Case of the Do’s and Don’ts” Matthew 5,6,22

SOLVED

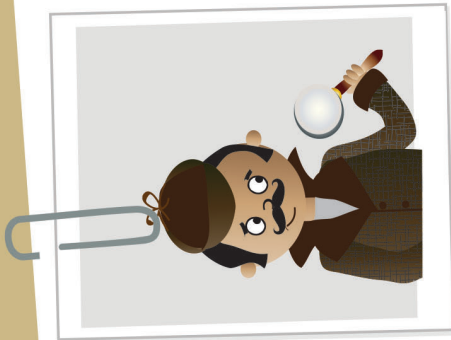

Detective Dan’s Listening Assignment #1

1. Who made up extra, little rules of do’s and don’ts? The pharisees.
2. What did Jesus think of those extra do’s and don’ts? What did Jesus say God’s real laws help people to do? Jesus knew those do’s and don’ts weren’t what pleased God. Jesus said God’s real laws help people love God most of all and love others.

For You and Me:
None of us can ever obey God’s laws well enough to please God or to truly love others as God wants us to. Only keeping God’s laws perfectly can do that, and we are all lawbreakers! Our only hope is to turn away from our sins and trust in Jesus as our Savior. He is the only way we can please God. God can work in our hearts and help us to better love others as He wants us to. Ask Him to help you. He loves to answer this prayer!



Detective Dan’s Listening Assignment #2

Matthew 22:37,39, ESV

“Love the Lord your God with all your heart, soul and mind... Love your neighbor as yourself.”

1. Which laws did Jesus tell people to obey? God’s laws.
2. Who is the only person to obey God’s laws perfectly? How did He share His perfect life with us? Jesus. He gave it up on the cross as the full payment for the sins of God’s people when He suffered and died on the cross.

For You and Me

How amazing that Jesus obeyed God’s laws perfectly! It’s even more amazing that He offers to share His perfect life with us, that we might be saved! This is His promise to all who turn away from their sins and trust in Him as their Savior. Ask Him to help you do this. He loves to answer this prayer!

DDD 7.3 Simple Story Scenes

What Are God's Laws Like?
God's Laws Are Perfect...

They Tell Us How to Love God and Others!

The Gospel



God's laws tell us how to love God and others, but we are all lawbreakers. We do not love as we should. God would be fair to give us the punishment we deserve for breaking His laws, but He is so rich in mercy. He sent His Son, Jesus, to be our Savior. Jesus obeyed God's laws, and loved God and others perfectly.

On the cross, Jesus suffered and died, giving His perfect life as the full payment for the sins of God's people. On the third day, Jesus rose from the dead, beating sin and death for them.

Now, all who turn away from their sins and trust in Him as their Savior can be God's people. They will know God in their hearts, now. And one day, they will go to live with Him forever.

We can be God's people when we turn from our sins and trust in Jesus as our Savior.



DDD 7.3 Simple Story Scenes

A Prayer

A We praise You, God, for being the Giver of Your perfectly good laws. They tell us how to love You and love others.

C God, many times we do not obey Your good laws. Many times, we do not love You or others as Your laws tell us to. We need a Savior!

T Thank You, God, for giving us Your good laws that show us how to love You and others. Thank You for sending Your Holy Spirit to live in our hearts, when we trust in Jesus as our Savior. He helps us to obey Your good and loving laws.

S God, work in our hearts. Help us to turn away from our sins and trust in Jesus as our Savior. Send Your Holy Spirit to live inside our hearts and help us to love You and others as You want us to.

In Jesus' name we pray. Amen.



DDD 7.3 Simple Story Scenes

DEEP DOWN DETECTIVES



Other Visual Aids

Big Question Box/Briefcase

What You Want

The Big Question Briefcase is a briefcase or other container with these characteristics:

- Ideally, this should be around 17" x 12", but needs to be at least big enough to fit a 8 ½" x 11" sheets of paper inside it.
- Have various pockets to put these sheets in
- Is attractive or curious looking to preschoolers
- Not necessary, but extremely fun, if it has a combination lock

Finding a Briefcase:

You can certainly buy one new, but you always may find a used one at a thrift shop. Or, someone may have one they want to donate. We use one that stores valuables in it and is the 17" x 12" size. Very durable and has the lock feature that the kids love.

You also can move away from the briefcase idea and use a little trunk or other box for your substitute briefcase. Just change the name to the Big Question Box, if you use a box instead. A boot box or the cardboard box that 10 reams of copy paper comes in is a great size, if you are using a box.

If you use a box, but want a lock-like feature, that's easy to do. Simply cut "straps" out of felt or vinyl and glue in place to the top and bottom sides of the box on one side, with the top strap overlapping the bottom straps. Add velcro to the top and bottom pieces so that they meet and fasten. Make back "hinges" for the box with the felt/vinyl straps, too. Or, you can simply add a belt around the box that has to be unfastened before the box can be opened.

Here are some suggestions for decorating a box or even the outside of your briefcase to make it appealing.

Supplies

Your box/briefcase
Plain white contact paper or white cardstock
Colorful wrapping paper
Glitter glue
Markers
Sequins, fake jewels, buttons, rick rack, etc.
Other decorating supplies
Stickers
Glue
Clear packing tape

Directions

1. If you are using a box that has wording on it, you will first need to make plain surfaces for decorating and a hinge for the lid. Stick the white contact paper or white cardstock to each side of the box. On the other hand, you can also use colorful wrapping paper. Then, make a lid by sticking the clear packing tape along one long side of the box, attaching the lid to the box.

2. Use the craft decorating supplies to decorate the box. If desired, you can put a big question mark on top of the box, but remember that you are working with two and three year olds: the question mark symbol is not very meaningful to them yet.

Making a Flannelgraph Storyboard

for use in story-telling and in playing the story review games

While you may decide to use sticky tac and stick your storyboard pictures to a white board, it is very easy to make a flannelgraph board. The advantage to the flannelgraph board is that the pictures stick very easily and there is no messing with the sticky-tac.

Supplies

Large Format Pictures Board: AT LEAST a 36" x 48" foamboard or corkboard (We actually use a far bigger canvas and attach it to the wall) A science project board with the two sides that fold out makes a good 36" x 48" board.

OR, Small Format Pictures Board: AT LEAST a 24" x 36" (to 36" x 48)" board

Large piece of neutral-colored felt to cover your board with extra to overlap over to the back, if desired.

Glue gun and glue sticks

Directions

1. Center felt on front side of board. Turn over. Secure in place with glue.

Making Durable Storyboard Pictures or Story Scenes

for use in story-telling and in playing the story review games

Whether you purchase the Deep Down Detectives storyboard pictures from Amazon or print them off the website (included in the Deep Down Detectives Visual Aids book), you will want to find some way to make them more durable. They are used not only as a part of telling the story, but are integral in the story review games. Here's how we make ours durable enough to be used over and over again. **See note below for other simpler options for using these pictures.**

Supplies

Deep Down Detectives Visual Aids book (purchased or downloaded)

White cardstock or printer paper (if downloading pictures)

Sticky-back velcro, circles or cut pieces; or sticky tac putty

Laminator or Self-laminating sheets

Sturdy Sheet Protectors, preferably the "Secure Top" kind, like offered by Avery

Flannelgraph pictures for the Bible stories found at www.praisefactory.org with each unit's resources.

Directions

1. Purchase from Amazon or download and print out the storyboard figures.

2. Cut out flannelgraph figures.

3. Laminate the figures.

Special tip: When laminating the big background pictures that are two (and sometimes even three or four) pieces put together, leave a small gap between the two pieces before laminating together. This small space acts like a hinge and allows you to fold up pictures without hurting them into a manilla envelope that fits 8.5" x 11" sheets of paper along with all of the smaller, regular-sized storyboard pictures.

4. If using a flannelgraph board: Stick a piece of sticky backed velcro (ROUGH SIDE) onto the back of each figure. If using sticky tack and whiteboard: simply stick a small amount of sticky tack on the back of a picture when using it. Remove and store sticky tack in airtight container.

Note: Instead of using all of the pictures as separate flannelgraph pieces, you can choose to use only a few (helpful to have 10 for the story review game); you can clump them onto posterboard and make them into picture scenes; or, you can simply use the Storyboard Picture Guide as a single picture. At praisefactory.org, go to DDD Bits and Pieces for a 22" x 28" poster size jpg of this picture guide if you want to create a large version.

The Deep Down Detectives “Bible” Folder

This is a homemade folder that looks (kinda) like the cover of a Bible. You will use this to put the Bible verse, the Bible Story and storyboard pictures to help make the point that the truths you are teaching them come from the Bible.

Supplies

1 piece of 22" x 28" posterboard (white is fine. Green or brown is nice)

Glue

Stapler and staples or packing tape

The Bible Cover pictures (see online with resources for this unit or from the back of each Deep Down Detectives Visual Aids book.)

NOTE: The Bible Cover pictures included in the Deep Down Detectives Visual Aids books cannot be created larger than 8.5" x 11". That means that they will be under-sized for a Bible Folder of the dimensions you are making. However, you can go online to the Deep Down Detectives curriculum and there is a pdf of a bigger version of these covers that will actually fit the size of this Deep Down Detectives “Bible” Folder.

Directions

1. Lay out poster board with long side along the bottom.
2. Fold in 2" on each side.
3. Take packing tape and tape the folded in 2" flaps to the main section of the posterboard, all the way down.
3. Fold up 8 1/2" on the bottom of the poster board.
4. Use packing tape to tape this flap in place, all the way down.
5. Take scissors and snip through the tape where the flap is attached to the folder. This will give you a bit more room in the folder.
6. Fold the poster board in the middle to make the center fold.
7. Cut out the Bible Cover Pictures. If possible, laminate these. They will last longer.
- 8.. Glue the two cover pieces to the outside of the folder.

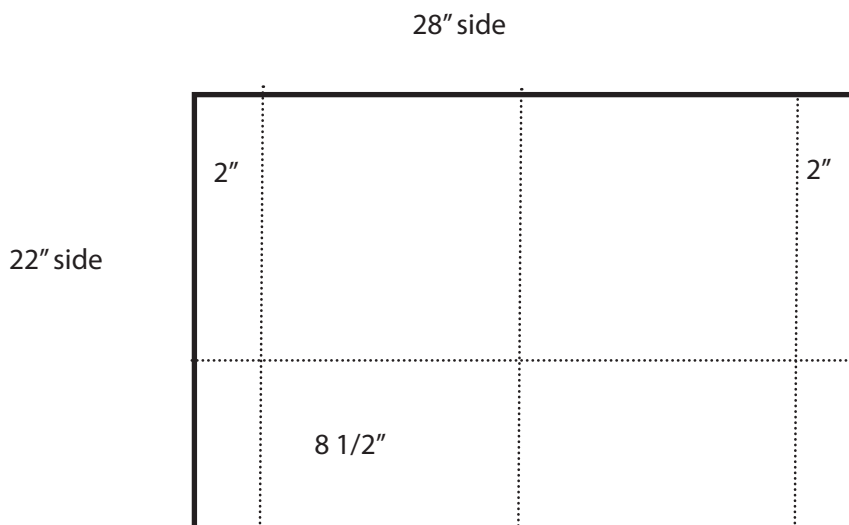

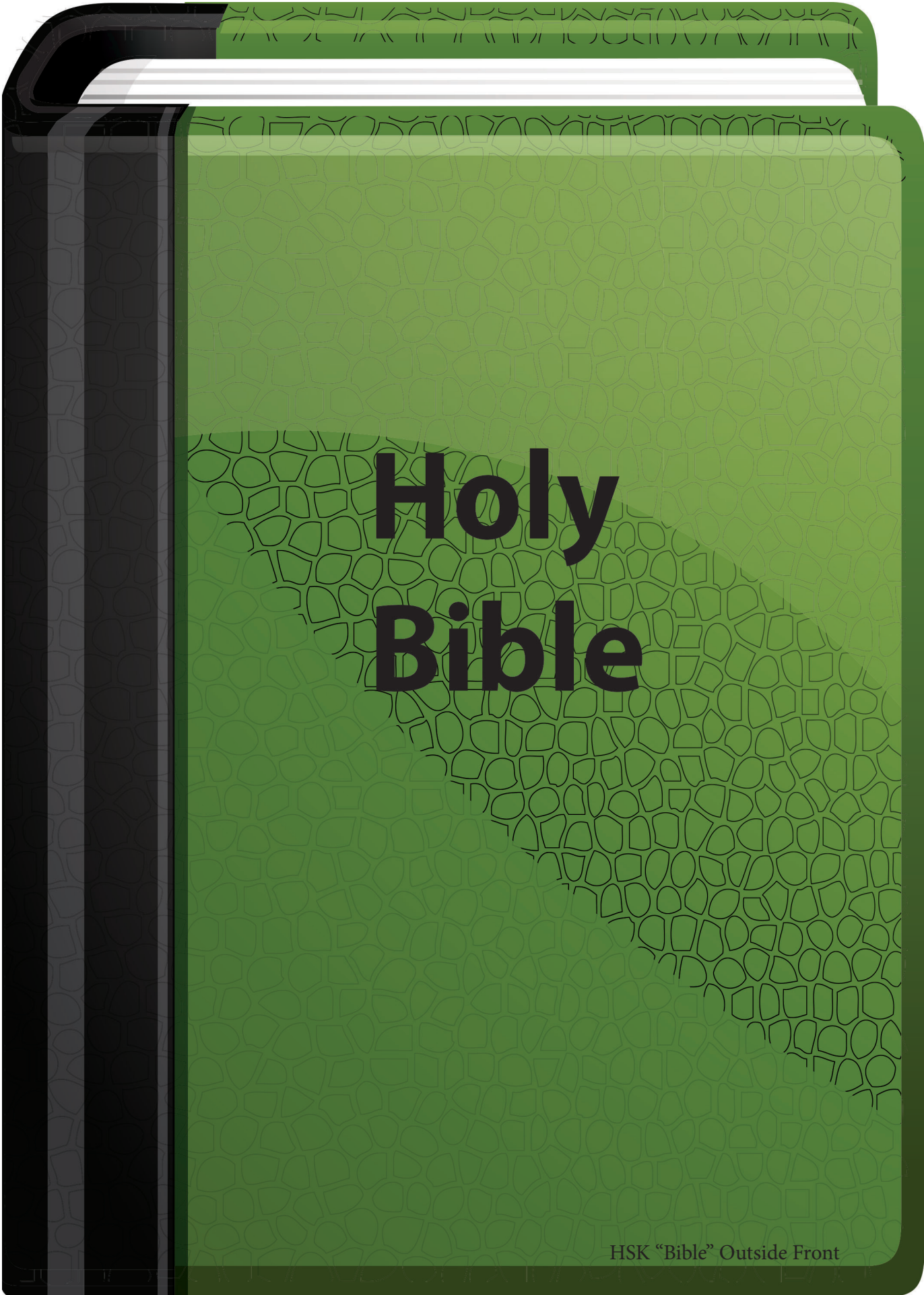
The image shows the front cover of a Bible. The cover is a vibrant green color with a repeating pattern of irregular, rounded shapes, resembling a stone or mosaic texture. The text "Holy Bible" is printed in a large, bold, black sans-serif font, centered on the cover. The spine of the Bible is visible on the left side, showing a dark grey or black material with a similar textured pattern. The top edge of the Bible is slightly rounded, and the pages are visible at the top, appearing as a stack of white lines.

Holy Bible

DDD "Bible" Outside Front



DDD "Bible" Outside Back

