

# **DEEP DOWN DETECTIVES**



**Unit 7**

**Simple Story Scenes, ESV**



Curriculum for preschool and elementary age children,  
training tools, music and other resources  
are available for download or to order at:  
[www.praisefactory.org](http://www.praisefactory.org)

© 2022 Praise Factory Media all rights reserved. May be reproduced by licensed user for classroom purposes only.

This and many other resources are available online at [www.praisefactory.org](http://www.praisefactory.org)

Scripture quotations marked (NIV) are taken from the Holy Bible, New International Version®, NIV®, Copyright © 1973, 1978, 1984 by Biblica, Inc.™ Used by permission of Zondervan. All rights reserved worldwide.[www.zondervan.com](http://www.zondervan.com)

Scripture quotations marked (ESV) are from The Holy Bible, English Standard Version® (ESV®), copyright © 2001 by Crossway, a publishing ministry of Good News Publishers. Used by permission. All rights reserved.

Scripture quotations marked HCSB are taken from the Holman Christian Standard Bible®, Copyright © 1999, 2000, 2002, 2003, 2009 by Holman Bible Publishers. Used by permission. Holman Christian Standard Bible®, Holman CSB®, and HCSB® are federally registered trademarks of Holman Bible Publishers.



# Table of Contents

<b>About the Deep Down Detectives Visual Aids</b>	<b>5</b>
<b>Unit 7: The Law-Giving God</b>	
<b>What Are God’s Laws Like? God’s Laws Are Perfect!</b>	
<b>Bible Truth 1: They Are Written in the Bible, God’s Word</b>	<b>9</b>
Bible Truth 1 Overview	11
Story Scenes	13
<b>Bible Truth 2: They Show Us that We Need God to Save Us</b>	<b>55</b>
Bible Truth 2 Overview	57
Story Scenes	59
<b>Bible Truth 3: They Tell Us How to Love God and Others</b>	<b>113</b>
Bible Truth 3 Overview	115
Story Scenes	117
<b>Take-Home Sheets</b>	<b>169</b>
Bible Truth 1	171
Bible Truth 2	177
Bible Truth 3	183

## Deep Down Detectives Curriculum Resources

There are five companion resources for each of the sixteen units of Deep Down Detectives. Use whichever resources are useful to your setting. Deep Down Detectives resources are available as free, digital downloads at [praisefactory.org](http://praisefactory.org), or for purchase as hard copies through [amazon.com](http://amazon.com).

Make sure to check out the “Bits and Pieces” section of the Deep Down Detectives curriculum online. It has all of the resources separated out making it easy for you simply to pick, choose and print out whatever you want.

### **Deep Down Detectives Core Curriculum Book, ESV/NIV for each unit**

The Deep Down Detectives Core Curriculum book contains the curriculum introduction, the lesson plans, stories, music, activities and take home sheets for each of the units.

### **Deep Down Detectives Visual Aids with Simple Story Scenes, ESV/NIV for each unit**

This resource provides large, colorful signs of the key concepts used in the unit, PLUS, easy-to-use, colorful scenes that you hold up in sequence as you tell the story. The story text for each scene is printed on the bottom of each scene.

### **Deep Down Detectives Simple Story Scenes, ESV/NIV for each volume**

This resource includes only 2-page overview for Bible Truth, the story scenes, and take home sheets. This is a great, basic resource for use at home and in many classroom teaching situations.

### **Deep Down Detectives Small Format Visual Aids, ESV/NIV (Small Format Storyboard Pictures) for each volume**

This resource provides large, colorful signs of the key concepts used in the unit, PLUS, colorful storyboard (flannelgraph) pictures to cut out and use as you tell each story. These storyboard pictures are for use with storyboards at least 24" x 36" in size.

### **Deep Down Detectives Large Format Visual Aids, ESV/NIV (Large Format Storyboard Pictures) for each volume**

This resource provides large, colorful signs of the key concepts used in the unit. It also provides colorful storyboard (flannelgraph) pictures to cut out and use as you tell each story. These storyboard pictures are for use with storyboards 36" x 48" in size.

All of these materials may be photocopied for non-commercial church, classroom or school use by licensed users.

## Other Resources in the Praise Factory Family of Curriculum

Deep Down Detectives is the second in a family of three, inter-related curriculums:

- Hide 'n' Seek Kids (focus group: ages 2-4; adaptable range: ages 2-pre-K 5's)
- Deep Down Detectives (focus group: ages 4--6's; adaptable range: ages 3-2nd grade)
- PFI: (focus group: grades K-5th grade; adaptable range: pre-K 5's-6th grade)

Each curriculum teaches the same biblical themes, but are presented in greater depth as the children grow and develop. Together, the curriculums work like an expanding spiral of truth that returns to reinforce the same truths with each curriculum, yet leading the children to deeper understanding with each step up.

Learn more about these curriculums as well as other resources and ideas for reaching children with the gospel at: [www.praisefactory.org](http://www.praisefactory.org).

## About the Deep Down Detectives Visual Aids

### How Are They Used?



The Deep Down Detectives Visual Aids book is a companion resource to be used alongside the Deep Down Detectives Core Curriculum book for each unit. These colorful pictures are used in presenting the key concepts; telling the Bible stories; and, in playing the Bible Story Review games.

### What Do They Include?



**There are four different resources included in this book:**

**1. Key Concept Visual Aids**-- colorful signs of the Big Question and Answer, the Bible Truth, the Bible verse, and the Listening Assignments to use with the 3 lessons for each Bible Truth.

**2. The Story Scenes Placement Page**--where to place the pictures on your storyboard.

**3. The Story Scenes, themselves.** Notice that each scene is numbered and that there is a brief summary of the story that corresponds to the picture. You can actually just tell the story in a simple way by using only the text at the bottom of each Story Scene.

**5. Directions** for making the Deep Down Detectives "Bible" Folder and the **back/front images** to paste in place when making it. (Larger back/front images are found online with the curriculum.)

**Directions** for how to make a homemade flannelgraph storyboard and sturdy Story Scene pictures are found in the back of this book.

### Ready, Set, Rip It Out!

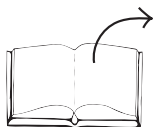

This book is meant to be ripped up and made into your visual aids. The key concept signs can be cut out and laminated or slipped into sheet protectors. The Story Scenes can be put in sheet protectors or laminated, too.

### Store It!



Deep Down Detectives is a curriculum that can be used over and over. Store your visual aids and storyboard pictures after using them and they will serve you for many years. We store ours in manilla envelopes and then put them (along with all the rest of the curriculum) in magazine files, labelled by Bible Truth. If you have multiple classes using the curriculum, store each set of resources in separate manilla envelopes. This will make prep much simpler, second time around.

### Replacement Story Scene Pictures



You can always purchase this book again or simply go online and print out any scenes that go missing.

### Other Options

You can also choose to tell the story in a more traditional flannelgraph way by using your own flannelgraph figures or by purchasing/free downloading the Storyboard Pictures (large and small format size available). This is more complex and requires more preparation, but some love it. And, it does allow for kids to interact more by helping to place pictures up on the board as you tell the story.



---

## Unit 7: The Law-Giving God

---

### UNIT OVERVIEW

A law is a big rule made by someone in charge. God is our Maker. He is in charge of everyone in the whole world. He has given us His laws to live by.

God is good and loving, wise and fair. He is perfect! God's laws are just like Him. They are good and loving, wise and fair, too. They are perfect!

God's laws show us the very best way to live. They show us how to love God and love others. They are exactly what we need.

In this unit we will learn three truths about the laws God has given us.

### UNIT BIBLE VERSE: Psalm 19:7, ESV

"The law of the LORD is perfect."

### BIG QUESTION UNDER INVESTIGATION: What Are God's Laws Like?

**ANSWER:** God's Laws Are Perfect!

#### OPTIONAL Big Question 7 INTRODUCTION LESSON (Use Hide 'n' Seek Kids Unit 7 Material)

Story: The Case of the Big Voice

Bible Verse: Exodus 19-20, 24

#### BIBLE TRUTH 1: They Are Written in the Bible, God's Word (3 Lessons Available)

Story: The Case of the Big Ten *Deuteronomy 5:1,7-21*

Bible Verse: Exodus 16,19,20

#### BIBLE TRUTH 2: They Show Us that We Need God to Save Us (3 Lessons Available)

Story: The Case of the Rotten Innards *Luke 18:9-14*

Bible Verse: Luke 18:9-14

#### BIBLE TRUTH 3: They Tell Us How to Love God and Others (3 Lessons Available)

Story: The Case of the Do's and Don'ts *Matthew 5,6,22*

Bible Verse: Matthew 22:37-40



---

## Deep Down Detectives ESV Songs 7 Track Numbers

---

This is a listing of all songs mentioned in the unit curriculum. You may or may not choose to use all of the songs. They are listed in easy-reference order--NOT in the order used in the curriculum.

You may choose to simply burn a CD/load them onto an mp3 device in this order. Or, you may want to do what we do: choose the songs we want to use and create a play list of them in that order. Then, we burn a CD/upload the play list onto an mp3 device. A teacher only has to click forward to the next song, instead of hunting for the right track. The track number have been included as part of the title of each song, teachers will still have a reference to the track number listed in the curriculum (same as those listed below), even if you change the order on your customized play list.

### SONGS USED EVERY UNIT OF THE CURRICULUM

- 1 The Classroom Song v.1
- 2 The Classroom Song v.2
- 3 The Classroom Song v.3
- 4 The Classroom Song v.4
- 5 Deep Down Detectives Theme Song
- 6 The Classroom Rules Song
- 7 Let's Pray Song
- 8 The Big Question Box Song
- 9 The Bible Chant Song
- 10 ACTS Prayer Song (Short Version)
- 11 ACTS Prayer Song (Full Version)

#### Why the Extra Songs?

Deep Down Detectives is a curriculum used by a wide age-span of kids. Sometimes one of the other songs is a better fit for your kids. Or, you may simply want to teach them more songs on the same Bible Truth. Use as many or as few as you want.

### UNIT 7: THE LAW-GIVING GOD

- 12 Big Q & A 7 Song
- 13 Big Question 7 Song: What Are God's Laws Like?
- 14 Big Question 7 Bible Verse Song: The Law of the Lord Psalm 19:7, ESV
- 15 *Extra Big Question 7 Bible Verse Song: The Law of the Lord Is Perfect Psalm 19:7, ESV (full version)*
- 16 *Extra Big Question 7 Bible Verse Song: The Law of the Lord Psalm 19:7, ESV (short version)*
- 17 Big Question 7 Hymn: Holy Bible, Book Divine
- 18 Big Question 7 Praise Song: The Best Book to Read Is the Bible

#### What Are God's Laws Like?

##### God's Laws Are Perfect...

#### Bible Truth 1: They Are Written in the Bible, God's Word

- 19 Bible Verse: Hear, O Israel Deuteronomy 5:1,7-21 , ESV (full version)
- 20 Bible Verse: Hear, O Israel Deuteronomy 5:1,7-21 , ESV (short version)

#### Bible Truth 2: They Show Us that We Need God to Save Us

- 21 Bible Verse: By Works of the Law Romans 3:20-23, HCSB
- 22 *Extra Bible Verse: Now We Know Romans 3:19-24, ESV*
- 23 *Extra Bible Verse: For Christ Suffered Once for Sins 1 Peter 3:18, ESV*
- 24 *Extra Bible Verse: The Lord Looks Down Psalm 14:2-3, HCSB*
- 25 *Extra Bible Verse: All We Like Sheep Isaiah 53:6, ESV*
- 26 *Extra Bible Verse: Seek the Lord Isaiah 55:6-7, ESV*

#### Bible Truth 3: They Tell Us How to Love God and Others

- 27 Bible Verse: Love the Lord Matthew 22:37-40, ESV

listen to or download songs for free at <https://praisefactory.org>: Deep Down Detectives Music page

# **DEEP DOWN DETECTIVES**



**Simple Story Scenes**

**Unit 7,**

**Bible Truth 1**

## Using Simple Story Scenes as a Curriculum

### Introduce the Key Concept and Bible Verse

Simple Story Scenes give you the basics for the core of your lesson. You can use the overview sheet to introduce and explain the key concept and Bible verse.

### Give the Case Assignment

Give the children a Detective Dan listening assignment. Two are provided. You can add a third using the ideas on the bonus, third take-home sheet, if desired. Each listening assignment, let's you teach the story with a different learning emphasis.

### Show & Tell the Story

Hold up the pictures and tell the story from the story scenes. Alternatively, you can find in the and Pieces section for this unit at [praisefactory.org](http://praisefactory.org), these same listening assignments and story scenes, gospel and ACTS prayer modified for view on a screen. Simply download them or open them online and show through your own monitor (tablet, big screen, whatever).

### Solve the Case

Repeat Detective Dan's listening assignment question and discuss the answer.

### Share the Gospel

Share the gospel tie-in with the kids.

### Close in ACTS Prayer

Pray the ACTS prayer with the kids. If using the curriculum with older children, give them a chance to think up their own ACTS tie-ins to the story, using the one provided as cues/ideas for you.

### Review Time

Give out the take-home sheet (there are three: two that correlates to the two Detective Dan assignments in the Story Scenes, and a bonus third one.) As the children are coloring, use the take-home sheet discussion questions or your own questions to further review and apply the key concepts, Bible verse, and story truths to the children.

### Looking for more?

Online, in the Bits and Pieces section for this unit, you will find review games, crafts, storyboard flannelgraph figures, and audio and sheet music for all of the songs. There are also full lesson plans that offer more of a script and take this curriculum's possibilities to much more depth. Don't forget to tell the parents about the Parents Resources section where they can read through the Story scenes and download take homes with their kids.

**Unit 7: The Law-Giving God**

**Unit Big Question (and Answer):** What Are God's Laws Like? God's Laws Are Perfect!

**Unit Bible Verse:** "The law of the LORD is perfect." Psalm 19:7

**Bible Truth 1 Concept: God's Laws Are Perfect... They Are Written in the Bible, God's Word!**

A law is big rule that we are supposed to obey. God told His laws to godly people long ago. These people wrote them down in the Bible, God's Word, so everyone can know them. God's Holy Spirit helped them write them down just right.

God's laws are the most important laws of all. They are rules that God wants everyone to keep. That's why God's people take time to learn God's laws and ask Him to help them obey them. They love God and want to please Him. They want to show the world what God is like by living the way He wants us to live.

**Bible Truth 1 Bible Verse: Deuteronomy 5:1,7-21**

"Hear, O Israel, the statutes and the rules that I speak in your hearing today, and you shall learn them and be careful to do them... You shall have no other gods before me. You shall not make for yourself a carved image. You shall not bow down to them or serve them... You shall not take the name of the LORD your God in vain... Observe the Sabbath day, to keep it holy... Honor your father and your mother... You shall not murder. And you shall not commit adultery. And you shall not steal. And you shall not bear false witness... And you shall not covet... anything that is your neighbor's."

**Learn a Little:** "Hear the rules... learn them and be careful to do them."

**Meaning**

Long ago, the LORD gave the 10 Commandments and many other good laws to the people of Israel. The Israelites promised to keep them. He would be their God; they would be His people. He would bless them and take care of them. These verses are the Ten Commandments (laws) that God gave them. But even though God gave these laws to the people of Israel that day, they are laws for all of us to keep. They tell us how God wants us all to live.

**Bible Truth 1 ACTS Prayer**

- A** We praise You, God, for being the Giver of Your perfectly good laws.
- C** God, we confess that we break Your good laws. Sometimes, we do not obey our parents. Sometimes, we lie. Sometimes, we want things that belong to others. You made us to be law keepers, but we are all lawbreakers. We need a Savior!
- T** Thank You for giving us Your good laws, so we know how to love and obey You. Thank You for making sure they were written down just right in Your Word, the Bible. Thank You for sending Jesus to keep Your laws perfectly and make the way for people like us to be forgiven.
- S** God, work in our hearts. Help us to turn away from our sins and trust in Jesus as our Savior. Help us to learn Your good laws and obey them. Help us to love You by living for You and keeping Your good laws.

In Jesus' name we pray, Amen.

**Bible Truth 1 Story****The Case of the Big Ten**

*Deuteronomy 5:1,7-21*

**Songs Used in Bible Truth 1**

Big Q & A 7 Song

Big Question 7 Song: What Are God's Laws Like?

Big Question 7 Bible Verse Song: The Law of the Lord Psalm 19:7, ESV

*Extra Big Question 7 Bible Verse Song: The Law of the Lord Is Perfect Psalm 19:7, ESV (full version)*

Big Question 7 Hymn: Holy Bible, Book Divine

Big Question 7 Praise Song: The Best Book to Read Is the Bible

Bible Truth 1 Bible Verse Song: Hear, O Israel Deuteronomy 5:1,7-21 , ESV

listen to or download songs for free at <https://praisefactory.org>: Deep Down Detectives Music page



# “The Case of the Big Ten” Deuteronomy 5:1,7-21

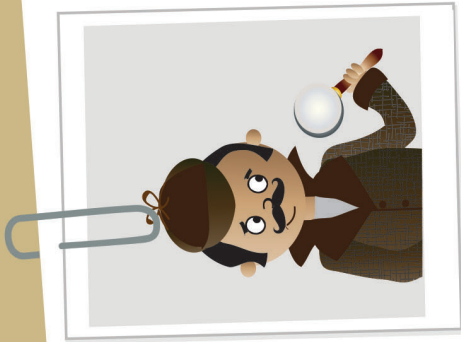

## Detective Dan's Listening Assignment #1

1. What were the “Big Ten”? What made them so big?
2. To whom did God give the “Big Ten” to obey?



## Detective Dan's Listening Assignment #2

### Deuteronomy 5:1, ESV

“Hear the rules... learn them and be careful to do them.”

1. How did God tell the people of Israel these Ten, Big Rules?
2. Why did the people need to know these rules?

(more listening and discussion questions are included in the curriculum at [praisefactory.org](http://praisefactory.org))

**I. “praise the LORD! He is the great, one, true God,” the Israelites shouted. They had so much to celebrate! God had freed us from their enemies, the Egyptians. He was taking them to a new home, a very special place called the Promised Land. Moses would lead them there.**

**How happy the Israelites were! Life would be good in God’s Promised Land.**

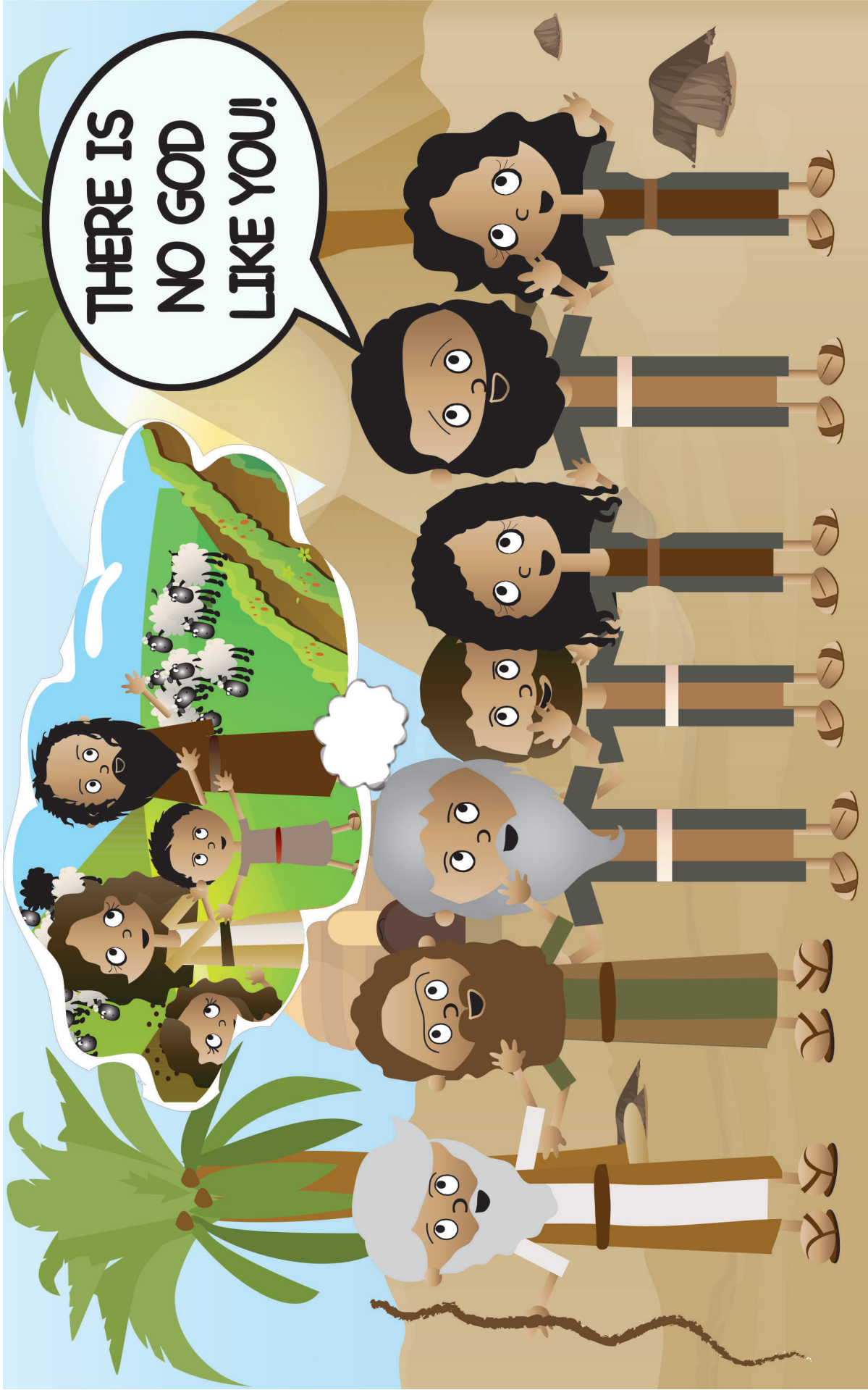

I. "Praise the LORD! He is the great, one, true God," the Israelites shouted. They had so much to celebrate! God had freed us from their enemies, the Egyptians. He was taking them to a new home, a very special place called the Promised Land. Moses would lead them there. How happy the Israelites were! Life would be good in God's Promised Land.

**2. But before they could go to their beautiful, new home, the people of Israel had to go somewhere else first. They had to great Mt. Sinai, out in the hot, dry desert. It was there, the LORD would meet with them and they would make promises to each other.**

**The LORD would promise to always take care of them and give them everything they needed. The people would promise to love and obey Him. This is how they would become God's people.**

**This is how they could live happily with the LORD and each other in the Promised Land. First, must come the promises; then, the Promised Land.**



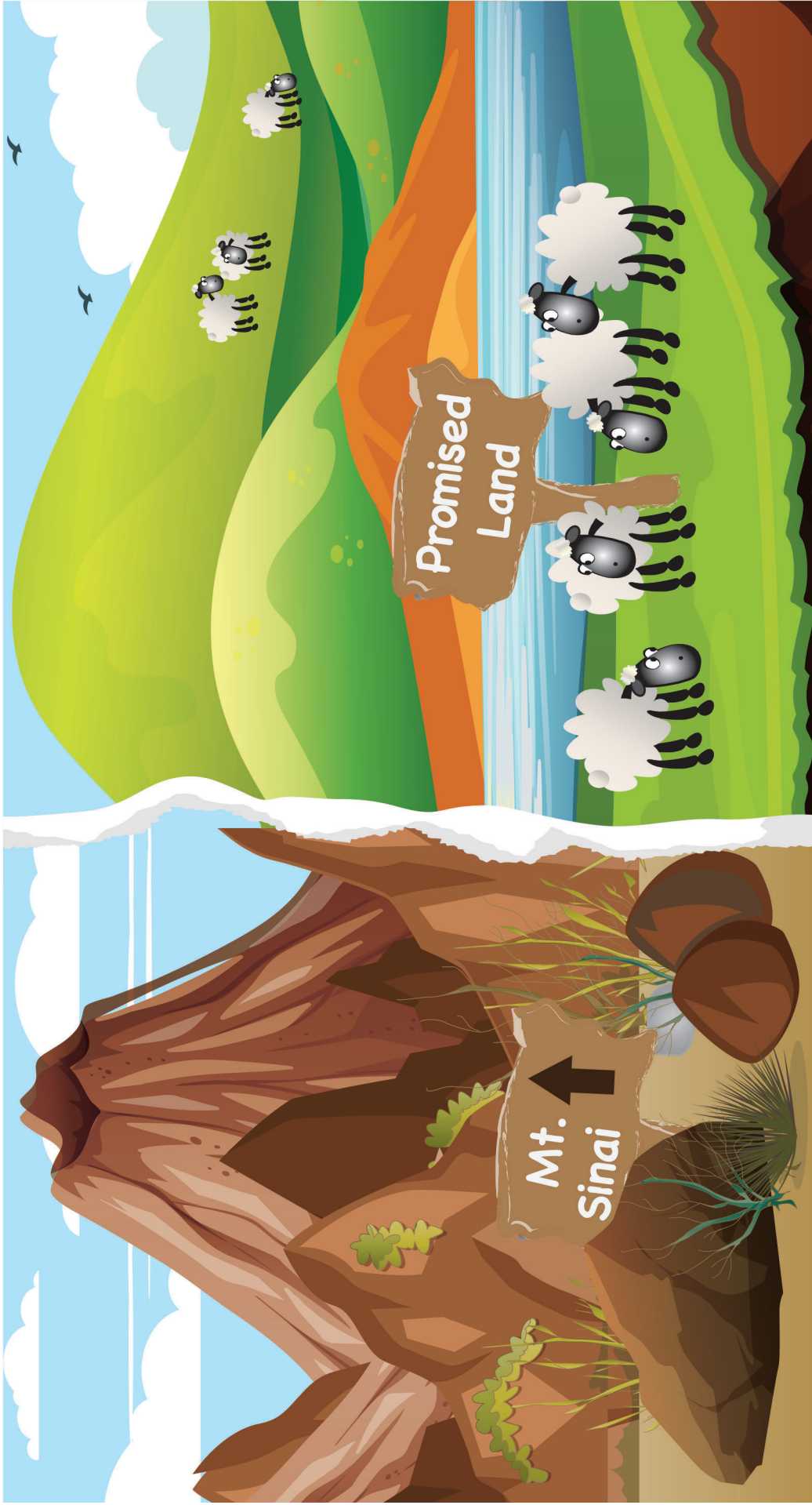

2. But before they could go to their beautiful, new home, the people of Israel had to go somewhere else first. They had to great Mt. Sinai, out in the hot, dry desert. It was there, the LORD would meet with them and they would make promises to each other. The LORD would promise to always take care of them and give them everything they needed. The people would promise to love and obey Him. This is how they would become God's people. This is how they could live happily with the LORD and each other in the Promised Land. First, must come the promises; then, the Promised Land.



**3. So, tramp, tramp, tramp, they went, across the dry, dusty wilderness. How very hot the sun was, as it beat down on them! There was hardly a cloud in the sky, or a tree on the ground, to give them any shade.**



3. So, tramp, tramp, tramp, they went, across the dry, dusty wilderness. How very hot the sun was, as it beat down on them! There was hardly a cloud in the sky, or a tree on the ground, to give them any shade.

**4. Day after day they traveled. At last, they reached Mt. Sinai, the very mountain where Moses had first met with the LORD. And in the shadow of that mountain, they set up their camp. As they worked, Moses headed to the mountain.**

**What was he going to do? Moses was climbing up to meet with the LORD.**



4. Day after day they traveled. At last, they reached Mt. Sinai, the very mountain where Moses had first met with the LORD. And in the shadow of that mountain, they set up their camp. As they worked, Moses headed to the mountain. What was he going to do? Moses was climbing up to meet with the LORD.

**5. "It's time to get the people ready to meet Me," the LORD told Moses. "I am holy, and the people are not. I can only meet with them if they are very, very careful."**

**"Tell them to set up fences around the bottom of this mountain, so that no animal or person will step foot on it. Have everyone take a bath and wash their clothes. Tell them to prepare their hearts for My coming," the LORD told Moses. "And tell them to do this in the next two days. On the third day, I will come to them."**



# THE LORD



5. "It's time to get the people ready to meet Me," the LORD told Moses. "I am holy, and the people are not. I can only meet with them if they are very, very careful. Tell them to set up fences around the bottom of this mountain, so that no animal or person will step foot on it. Have everyone take a bath and wash their clothes. Tell them to prepare their hearts for My coming," the LORD told Moses. "And tell them to do this in the next two days. On the third day, I will come to them."

**6. Moses went down and told the people all the LORD had said.**

**There was so much to do in two days! All the stone fence had to be put in place. All those people needed to take baths and wash their clothes. All those hearts must be made ready for the LORD.**

**Day One passed, then Day Two. Everything was completed. How exciting it must have been as everyone went to bed that second night! The LORD would meet with them the very next day. What would it be like?**



6. Moses went down and told the people all the LORD had said. There was so much to do in two days! All the stone fence had to be put in place. All those people needed to take baths and wash their clothes. All those hearts must be made ready for the LORD. Day One passed, then Day Two. Everything was completed. How exciting it must have been as everyone went to bed that second night! The LORD would meet with them the very next day. What would it be like?

**7. The next morning, they found out. Sinai was usually a land of bright sunshine and cloudless days, but not this day. The people awoke to the sound of loud rumbles of thunder and a blaring trumpet blast. They peered out of their tents to find Mt. Sinai covered in thick clouds with great flashes of lightning. Everyone trembled with fear.**





7. The next morning, they found out. Sinai was usually a land of bright sunshine and cloudless days, but not this day. The people awoke to the sound of loud rumbles of thunder and a blaring trumpet blast. They peered out of their tents to find Mt. Sinai covered in thick clouds with great flashes of lightning. Everyone trembled with fear.

**8. Moses led the people out of the camp to the very foot of Mt. Sinai.**

**They watched great, billowing clouds of smoke rise from it as the LORD descended on the top of the mountain in fire. They could feel the ground under their feet move as the whole mountain shook.**

**The LORD, the one, true God, had come to meet with them! Moses went up the mountain to talk with the LORD.**



8. Moses led the people out of the camp to the very foot of Mt. Sinai. They watched great, billowing clouds of smoke rise from it as the LORD descended on the top of the mountain in fire. They could feel the ground under their feet move as the whole mountain shook. The LORD, the one, true God, had come to meet with them! Moses went up the mountain to talk with the LORD.



**9. The trumpet blasted louder and louder, as the LORD and Moses spoke together on the mountain. Then, after making sure the people stayed off the mountain one last time, the LORD spoke in a loud voice for all the people to hear.**

**This is what He said to them: "I am the LORD your God who rescued you from your enemies, the Egyptians. I want to make special promises to you. I will love you and take care of you. You will be My people. But you must make special promises to Me, too. You must keep My laws, if you are to be My people." Here are My Ten Commandments:"**



9. The trumpet blasted louder and louder, as the LORD and Moses spoke together on the mountain. Then, after making sure the people stayed off the mountain one last time, the LORD spoke in a loud voice for all the people to hear. This is what He said to them: "I am the LORD your God who rescued you from your enemies, the Egyptians. I want to make special promises to you. I will love you and take care of you. You will be My people. But you must make special promises to Me, too. You must keep My laws, if you are to be My people." Here are My Ten Commandments:

**10. “Worship Me alone. Don’t make gods out of anything you see, in the sky or on the earth around you. Worship Me alone. I am the LORD. Honor My name. Don’t misuse it. Keep one day a week (the Sabbath day) a day of worship and rest,” the LORD told them.**



**1. Love Me most of all.**



**3. Love Me by how you talk  
about Me and how you live.**

10. "Worship Me alone. Don't make gods out of anything you see, in the sky or on the earth around you. Worship Me alone. I am the LORD. Honor My name. Don't misuse it. Keep one day a week (the Sabbath day) a day of worship and rest," the LORD told them.



**2. Don't worship fake gods.  
Worship only Me.**



**4. Keep a special day to  
rest and to worship Me.**



**II. “Honor your father and mother. Listen to them and obey them. Don’t murder anyone. Don’t treat someone else’s husband or wife as if they are yours. Don’t steal and don’t lie. Don’t covet. Don’t keep longing after something someone else has that you want. Be happy with what I give you.”**



**5. Love and obey your mother and father.**



**6. Don't murder people.**



**7. Keep your promise to love only your husband/wife.**



**8. Don't take other people's things.**

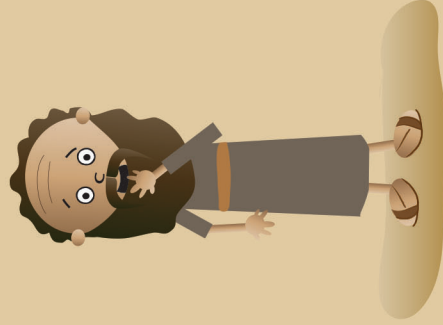

**9. Don't lie.**



**10. Don't be greedy for what others have.**

**II. "Honor your father and mother. Listen to them and obey them. Don't murder anyone. Don't treat someone else's husband or wife as if they are yours. Don't steal and don't lie. Don't covet. Don't keep longing after something someone else has that you want. Be happy with what I give you."**

**12. The people trembled with fear when they saw the crashing lightning and the fiery mountain, and heard the crashing thunder, the loud, heavenly trumpet, and the voice of God.**

**They stayed away from the mountain, and said to Moses, “Speak to us, yourself, and we will listen. We will do whatever the LORD wants us to do. We want to be His people. But don’t have Him speak to us. We’re so scared by His mightiness and holiness. We’re afraid we will die,” they exclaimed.**





12. The people trembled with fear when they saw the crashing lightning and the fiery mountain, and heard the crashing thunder, the loud, heavenly trumpet, and the voice of God. They stayed away from the mountain, and said to Moses, "Speak to us, yourself, and we will listen. We will do whatever the LORD wants us to do. We want to be His people. But don't have Him speak to us. We're so scared by His mightiness and holiness. We're afraid we will die," they exclaimed.

**13. “Don’t be afraid,” Moses told them. “The LORD hasn’t come to hurt you. He has come in this mighty way to show you what He’s like and to help you keep His good laws. You are making promises to the great, one true God to be His people. This is a big deal. He is warning you not to break your promises to Him,” Moses said.**

**“But because you are afraid, I will go and meet with God for you on the mountain, then I will come back down and tell you what He says.”**



13. "Don't be afraid," Moses told them. "The LORD hasn't come to hurt you. He has come in this mighty way to show you what He's like and to help you keep His good laws. You are making promises to the great, one true God to be His people. This is a big deal. He is warning you not to break your promises to Him," Moses said. "But because you are afraid, I will go and meet with God for you on the mountain, then I will come back down and tell you what He says."

**14. Away went Moses. The people watched as again he climbed up Mt. Sinai and disappeared in the thick, dark cloud to meet with the LORD.**

**Up on the mountain, the LORD, Himself, wrote His 10 Big, Laws into pieces of stone and gave them to Moses. Then, the LORD told Moses many other laws to teach the people, so they could know how to love Him and love each other.**

**“Write down all these laws, so the people will always know how to love and obey Me,” the LORD said.**





## Ten, Big Laws

14. Away went Moses. The people watched as again he climbed up Mt. Sinai and disappeared in the thick, dark cloud to meet with the LORD. Up on the mountain, the LORD, Himself, wrote His 10 Big, Laws into pieces of stone and gave them to Moses. Then, the LORD told Moses many other laws to teach the people, so they could know how to love Him and love each other. "Write down all these laws, so the people will always know how to love and obey Me," the LORD said.

**15. And that was what Moses did. He wrote down all of those good laws in the Bible, so that not just those Israelites, long ago, could know them; but, so all peoples, in all times, could know God's laws and how God's people should live. Even you and me!**



**15. And that was what Moses did. He wrote down all of those good laws in the Bible, so that not just those Israelites, long ago, could know them; but, so all peoples, in all times, could know God's laws and how God's people should live. Even you and me!**



**16. And, so that by those laws, we could get ready for the Savior.**

**How? By showing us that none of us live as God requires. We need a Savior, if we are to be God's people. It's the only way.**

**It's**



16. And, so that by those laws, we could get ready for the Savior. How? By showing us that none of us live as God requires. We need a Savior, if we are to be God's people. It's the only way.

**17. That Savior was Jesus, God's very own Son!**

**Jesus came and lived a perfect life. Only He obeyed all of God's laws. He gave His life as the full payment for the sins of all who turn away from their sin and trust in Him as their Savior. He died on the cross for them and rose from the dead in victory!**

**Through Jesus, we can become God's people. Ask Him to help you!**



17. That Savior was Jesus, God's very own Son! Jesus came and lived a perfect life. Only He obeyed all of God's laws. He gave His life as the full payment for the sins of all who turn away from their sin and trust in Him as their Savior. He died on the cross for them and rose from the dead in victory! Through Jesus, we can become God's people. Ask Him to help you!

## DDD 7.1 Simple Story Scenes



# "The Case of the Big Ten" Deuteronomy 5:1,7-21

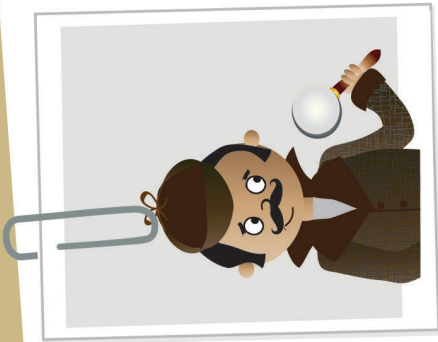

## Detective Dan's Listening Assignment #1

1. What were the "Big Ten"? What made them so big? The "Big Ten" were the Ten Commandments that the LORD gave the people of Israel at Mt. Sinai that day. We call them BIG because they are so important. They are the laws behind all of the other laws the LORD would give. They tell us how to love the LORD and love each other.
  2. To whom did God give the "Big Ten" to obey? The LORD first gave them to the people of Israel, but they are laws for all of us to obey.
- For You and Me:**  
The LORD wants all of us to obey His good laws. They are for us all to live by. But sadly, we all break them. That's why God sent Jesus to save us. He, alone, kept God's laws perfectly. Jesus gave His life as the full payment for the sins of God's people when He suffered and died on the cross. On the third day, Jesus rose from the dead in victory. He had beaten sin and death for God's people. How can we become God's people? By turning away from our sins and trusting in Jesus as our Savior. Ask Him to help you! He delights to do this!



## Detective Dan's Listening Assignment #2

Deuteronomy 5:1, ESV

"Hear the rules... learn them and be careful to do them."

1. How did God tell the people of Israel these Ten, Big Rules? He met with them at Mt. Sinai. He spoke to them, Himself, out of a dark, thick cloud from the mountain. He, Himself, wrote them down on stone tablets for them to have.
  2. Why did the people need to know these rules? They needed to know them, so they could obey them. This was part of making special promises with God to become His people.
- For You and Me:**  
All of us need to know God's Ten Commandments. God wants us to keep them if we are to be His people. But the sad truth is that none of us can ever keep God's laws as He wants us to. That's why we need a Savior if we are to be God's people. That Savior is Jesus. Jesus, God's Son, lived a perfect life. He always kept all of God's laws. Jesus gave His life as the full payment for the sins of God's people when He suffered and died on the cross. On the third day, Jesus rose from the dead in victory. He had beaten sin and death for God's people. How can we become God's people? By turning away from our sins and trusting in Jesus as our Savior. Ask Him to help you! He delights to do this!



## DDD 7.1 Simple Story Scenes

What Are God's Laws Like?  
God's Laws Are Perfect...

they are written in the Bible, God's Word!

God gave us His laws, so we could know how to live lives that please Him. We can read them in the Bible. But even though we know God's laws, we all disobey them. That's why we all deserve God's punishment for our sins. How sad!

But God is so rich in mercy. He sent His Son, Jesus, to live a perfect life. Yes, Jesus kept every, single one of God's laws! Jesus offered up His perfect life to God as the full payment for the sins of God's people, when He suffered and died on the cross. Then on Day Three, Jesus rose from the dead in victory. Jesus had beaten sin and death for God's people!

We can be God's people, too, when we turn away from our sins and trust in Jesus as our Savior. He loves to help us do this. Ask Him!

# The Gospel



## DDD 7.1 Simple Story Scenes

# A Prayer

**A** We praise You, God, for being the Giver of Your perfectly good laws.

**C** God, we confess that we break Your good laws. Sometimes, we do not obey our parents. Sometimes, we lie. Sometimes, we want things that belong to others. You made us to be law keepers, but we are all lawbreakers. We need a Savior!

**T** Thank You for giving us Your good laws, so we know how to love and obey You. Thank You for making sure they were written down just right in Your Word, the Bible. Thank You for sending Jesus to keep Your laws perfectly and make the way for people like us to be forgiven.

**S** God, work in our hearts. Help us to turn away from our sins and trust in Jesus as our Savior. Help us to learn Your good laws and obey them. Help us to love You by living for You and keeping Your good laws.

In Jesus' name we pray. Amen.



## DDD 7.1 Simple Story Scenes



# **DEEP DOWN DETECTIVES**



**Simple Story Scenes**

**Unit 7,**

**Bible Truth 2**

## Using Simple Story Scenes as a Curriculum

### Introduce the Key Concept and Bible Verse

Simple Story Scenes give you the basics for the core of your lesson. You can use the overview sheet to introduce and explain the key concept and Bible verse.

### Give the Case Assignment

Give the children a Detective Dan listening assignment. Two are provided. You can add a third using the ideas on the bonus, third take-home sheet, if desired. Each listening assignment, let's you teach the story with a different learning emphasis.

### Show & Tell the Story

Hold up the pictures and tell the story from the story scenes. Alternatively, you can find in the and Pieces section for this unit at [praisefactory.org](http://praisefactory.org), these same listening assignments and story scenes, gospel and ACTS prayer modified for view on a screen. Simply download them or open them online and show through your own monitor (tablet, big screen, whatever).

### Solve the Case

Repeat Detective Dan's listening assignment question and discuss the answer.

### Share the Gospel

Share the gospel tie-in with the kids.

### Close in ACTS Prayer

Pray the ACTS prayer with the kids. If using the curriculum with older children, give them a chance to think up their own ACTS tie-ins to the story, using the one provided as cues/ideas for you.

### Review Time

Give out the take-home sheet (there are three: two that correlates to the two Detective Dan assignments in the Story Scenes, and a bonus third one.) As the children are coloring, use the take-home sheet discussion questions or your own questions to further review and apply the key concepts, Bible verse, and story truths to the children.

### Looking for more?

Online, in the Bits and Pieces section for this unit, you will find review games, crafts, storyboard flannelgraph figures, and audio and sheet music for all of the songs. There are also full lesson plans that offer more of a script and take this curriculum's possibilities to much more depth. Don't forget to tell the parents about the Parents Resources section where they can read through the Story scenes and download take homes with their kids.

**Unit 7: The Law-Giving God**

**Unit Big Question (and Answer):** What Are God's Laws Like? God's Laws Are Perfect!

**Unit Bible Verse:** "The law of the LORD is perfect." Psalm 19:7

**Bible Truth 2 Concept: God's Laws Are Perfect... They Show Us that We Need God to Save Us!**

God made us and He is in charge of us. He expects us to obey His laws all the time. But sadly, we do not. We all are sinners with sinful, selfish hearts. We disobey God's laws. We deserve His punishment for our sins. How we have rebelled against Him and His good ways!

But God is so kind and merciful! He wants to treat us better than we deserve. He sent Jesus to take the punishment for the sins of all who trust in Him as their Savior. God forgives their sins and gives them special closeness with Him in their hearts. And when they die, they will go to live with Him forever in a perfect world where there will never again be any sin. Yes! They will never again sin against Him or break His good laws. They will always love Him and others as He wants them to. How wonderful that will be! Jesus can be our Savior, too, when we turn away from our sins and trust in Him as our Savior.

**Bible Truth 2 Bible Verse: Romans 3:20,21,22,23, HCSB**

For no one will be justified in [God's] sight by the works of the law...But now, apart from the law, God's righteousness has been revealed... God's righteousness through faith in Jesus Christ, to all who believe...For all have sinned and fall short of the glory of God.

**Learn a Little:** "Apart from the law, God's righteousness has been revealed... righteousness through faith in Jesus Christ, to all who believe."

**Meaning**

"Righteous" is a big word that means that you are right with God. The only way we can be right with God ON OUR OWN is by obeying God's laws perfectly. But, uh oh! This Bible verse tells us that we are all sinners who break God's laws. That means we can't EVER be right with God by obeying God's laws.

But God has made a way for us to be right with Him—through His Son, Jesus. Jesus came and lived a perfect life. He kept all of God's good laws perfectly. He was righteous! And this Bible verse tells us that for all who trust in Jesus as their Savior, Jesus takes away their sins and gives His righteousness to them. That means God treats them as if they had never broken God's laws or sinned—just like Jesus! Wow! Isn't that amazing! Isn't Jesus a wonderful Savior! He can be our wonderful Savior, too, when we turn away from our sins and trust in Him as our Savior.

**Bible Truth 2 ACTS Prayer**

- A** We praise You, God, for being the Giver of Your perfectly good laws.
- C** God, instead of obeying Your good laws, we have all chosen to break them. Sometimes, we don't obey our parents. Sometimes, we lie. Sometimes, we want things that belong to others. We do not always love you most of all. These are only some of the ways we break Your good laws. Oh, how we need a Savior!
- T** Thank You, God, for giving us Your good laws, so we know how to love and obey You. And thank You for sending Jesus to perfectly live out Your laws and to give His life as the perfect payment for the sins of Your people. Thank You that He can be our Savior when we turn away from our sins and trust in Him.
- S** God, work in our hearts. Help us to turn away from disobeying You and trust in Jesus as our own Savior. Help us to know You and love You with the spirit You put inside us. Help us to learn Your good laws and obey them. In Jesus' name we pray, Amen.

**Bible Truth 2 Story**

**The Case of the Rotten Innards** Luke 18:9-14

**Songs Used in Bible Truth 2**

---

Big Q & A 7 Song

Big Question 7 Song: What Are God's Laws Like?

Big Question 7 Bible Verse Song: The Law of the Lord Psalm 19:7, ESV

*Extra Big Question 7 Bible Verse Song: The Law of the Lord Is Perfect Psalm 19:7, ESV*

Big Question 7 Hymn: Holy Bible, Book Divine

Big Question 7 Praise Song: The Best Book to Read Is the Bible

Bible Truth 2 Bible Verse Song: By Works of the Law Romans 3:20-23, HCSB

*Extra Bible Truth 2 Verse Song: Now We Know Romans 3:19-24, ESV*

*Extra Bible Truth 2 Bible Verse Song: For Christ Suffered Once for Sins 1 Peter 3:18, ESV*

*Extra Bible Truth 2 Bible Verse Song: The Lord Looks Down Psalm 14:2-3, HCSB*

*Extra Bible Truth 2 Bible Verse Song: All We Like Sheep Isaiah 53:6, ESV*

*Extra Bible Truth 2 Bible Verse Song: Seek the Lord Isaiah 55:6-7, ESV*

listen to or download songs for free at <https://praisefactory.org>: Deep Down Detectives Music page

# “The Case of the Rotten Innards” Luke 18:9-14

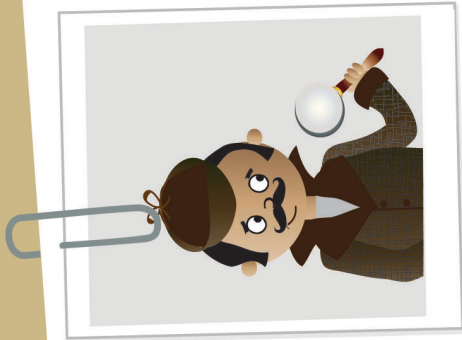

## Detective Dan's Listening Assignment #1

“Innards” is a funny word that means a person's insides. And in this case, it means a person's heart, meant to love and obey God.

1. Who had a rotten heart and knew it? Who had a rotten heart and DIDN'T know it?
2. What did Jesus want them all to do?



## Detective Dan's Listening Assignment #2

### Romans 3:20-22, HCSB

“For no one will be justified in [God's] sight by the works of the law... But now, apart from the law, God's righteousness has been revealed... God's righteousness through faith in Jesus Christ, to all who believe.”

1. Who thought they were justified (good) in God's sight? Why weren't they?
2. What did Jesus want these people to do?

(more listening and discussion questions are included in the curriculum at [praisefactory.org](http://praisefactory.org))



**I. Many sick people came to see Jesus. They came with their limping legs, their blind eyes, their skin with sores, and their bleeding that wouldn't stop. Some of them were about to die.**

**They all came to Jesus, and what do you think Jesus did? Jesus healed them with God's power! No doctor or medicine needed!**

**"Who has ever healed sick people the way Jesus does?" they exclaimed.**

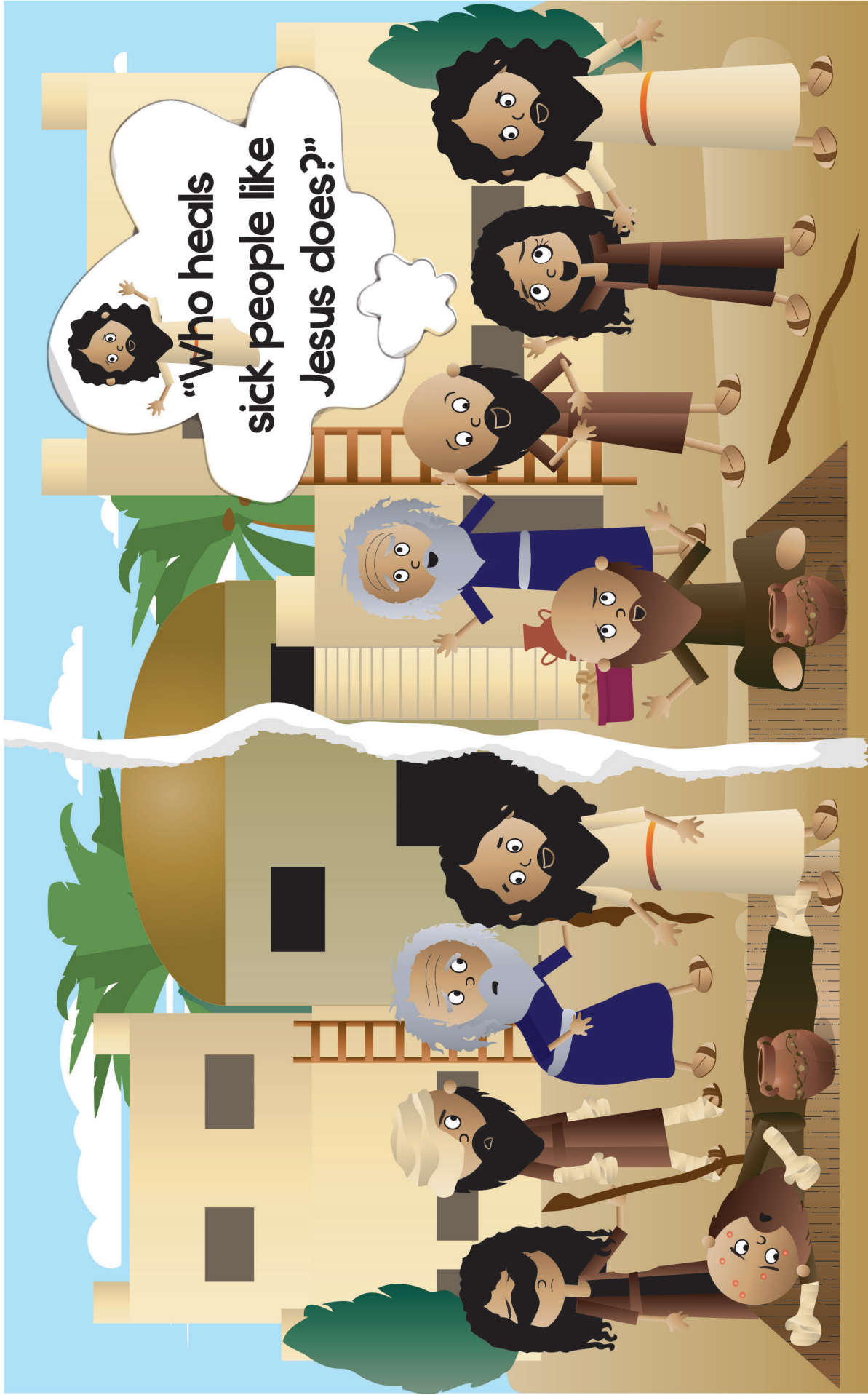

I. Many sick people came to see Jesus. They came with their limping legs, their blind eyes, their skin with sores, and their bleeding that wouldn't stop. Some of them were about to die. They all came to Jesus, and what do you think Jesus did? Jesus healed them with God's power! No doctor or medicine needed! "Who has ever healed sick people the way Jesus does?" they exclaimed.

**2. People who wanted to hear about God came to Jesus, too.**

**They crowded around Jesus, listening to everything He had to say. Jesus told them about God and His Kingdom. He told them how God wanted them to live. They listened to Jesus and were amazed at what He had to say.**

**“Who has ever told us about God the way Jesus does?” they exclaimed.**



2. People who wanted to hear about God came to Jesus, too. They crowded around Jesus, listening to everything He had to say. Jesus told them about God and His Kingdom. He told them how God wanted them to live. They listened to Jesus and were amazed at what He had to say. "Who has ever told us about God the way Jesus does?" they exclaimed.

**3. Even people who had done very sinful things came to Jesus.**

**Men and women who had disobeyed God's Ten Commandments in so many ways: people who had stolen money; people who had not loved their husbands or wives; people who had hurt other people; people who had worshipped other gods, and so many more.**

**They all came to Jesus, and what do you think happened? Jesus gave them God's forgiveness, when they turned away from their sins and trusted in Him.**

**"Who has ever forgiven sins the way Jesus does?" they exclaimed.**





3. Even people who had done very sinful things came to Jesus. Men and women who had disobeyed God's Ten Commandments in so many ways: people who had stolen money; people who had not loved their husbands or wives; people who had hurt other people; people who had worshipped other gods, and so many more. They all came to Jesus, and what do you think happened? Jesus gave them God's forgiveness, when they turned away from their sins and trusted in Him. "Who has ever forgiven sins the way Jesus does?" they exclaimed.

**4. Sick people, sinful people, people eager to learn about God, all came to Jesus, and He satisfied them. How wonderful, how amazing was Jesus!**



4. Sick people, sinful people, people eager to learn about God, all came to Jesus, and He satisfied them. How wonderful, how amazing was Jesus!

**5. But there was another kind of people who came to Jesus, too.**

**These people were different from all the rest. They weren't sick. They weren't eager to learn about God from Jesus. And most of all, they didn't even think they were sinners who needed God's forgiveness. They were the important Bible teachers back in Jesus' day.**

**They had a special name for themselves. Do you know what it was? They were called the Pharisees.**



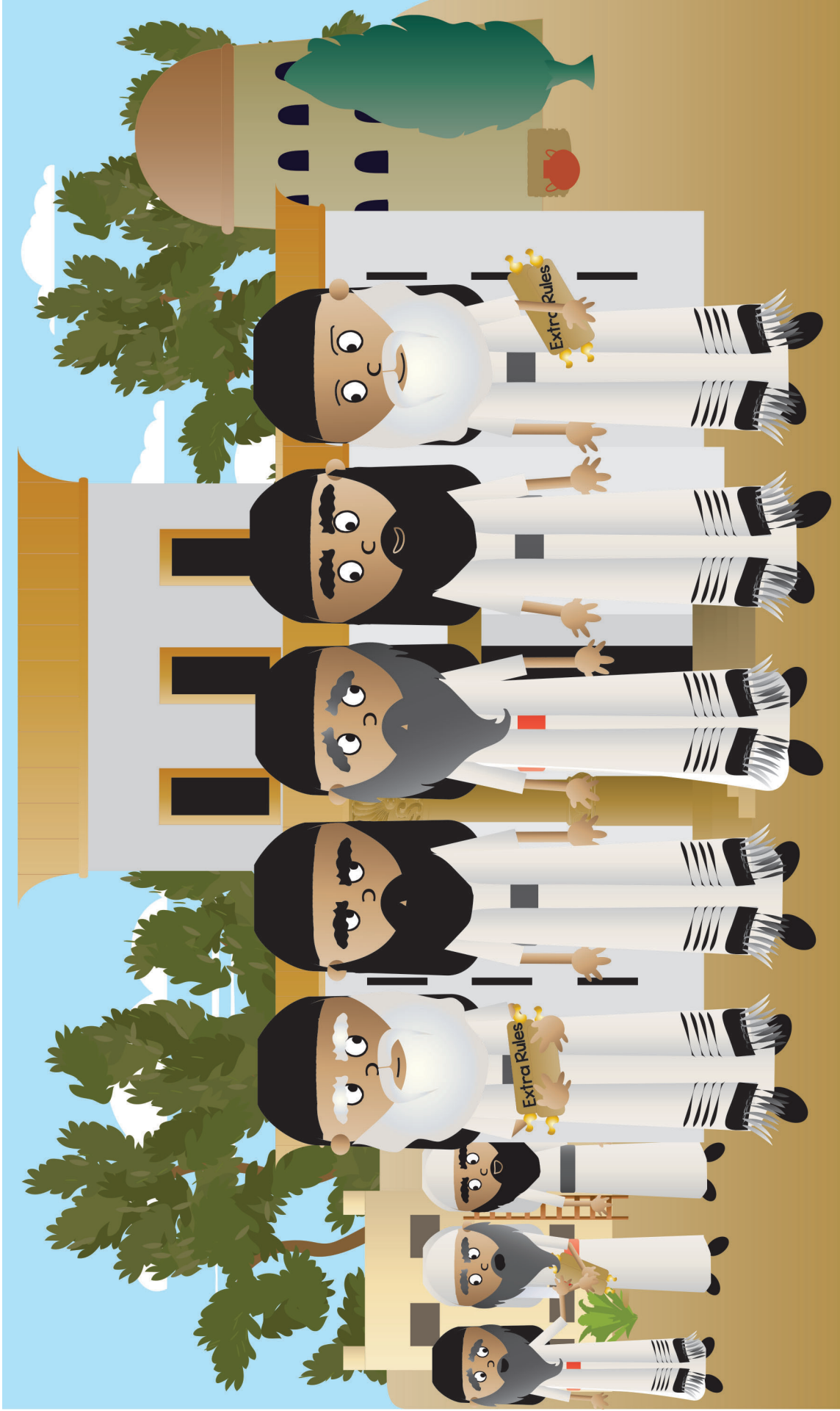

5. But there was another kind of people who came to Jesus, too. These people were different from all the rest. They weren't sick. They weren't eager to learn about God from Jesus. And most of all, they didn't even think they were sinners who needed God's forgiveness. They were the important Bible teachers back in Jesus' day. They had a special name for themselves. Do you know what it was? They were called the Pharisees.



**6. The Pharisees were smart students, and they studied hard.**

**Not only did they learn and try to obey God's Ten Commandments, but they learned and tried to obey the hundreds of God's other laws, too. They spent day after day, week after week, year after year, learning them all by heart! Wow!**



6. The Pharisees were smart students, and they studied hard. Not only did they learn and try to obey God's Ten Commandments, but they learned and tried to obey the hundreds of God's other laws, too. They spent day after day, week after week, year after year, learning them all by heart! Wow!

**7. But obeying God's laws wasn't enough for the Pharisees.**

**They wanted to be extra careful to please God, so they added a lot of extra, little rules for everyone to obey. Rules that God didn't give His people. They added extra rules about washing your hands just right. (Not to get rid of dirt or germs that might make you sick, as we do, but because they thought these specially cleaned hands were how you pleased God.)**



7. But obeying God's laws wasn't enough for the Pharisees. They wanted to be extra careful to please God, so they added a lot of extra, little rules for everyone to obey. Rules that God didn't give His people. They added extra rules about washing your hands just right. (Not to get rid of dirt or germs that might make you sick, as we do, but because they thought these specially cleaned hands were how you pleased God.)

**8. Those hand-washing rules were just the beginning of what the Pharisees added to God's laws.**

**There were also extra rules about food to eat or not eat, about giving extra gifts to God, and about what work you could NOT do on the Sabbath Day of Rest (such as not looking in a mirror because you might be tempted to pluck out a gray hair from your head), and lots more extra, little rules besides these! So many rules!**





# Extra Rules

8. Those hand-washing rules were just the beginning of what the Pharisees added to God's laws. There were also extra rules about food to eat or not eat, about giving extra gifts to God, and about what work you could NOT do on the Sabbath Day of Rest (such as not looking in a mirror because you might be tempted to pluck out a gray hair from your head), and lots more extra, little rules besides these! So many rules!

**9. The Pharisees tried very hard to obey all their extra, little rules. They wanted the people to obey them, too.**

**They thought those extra, little rules helped everyone keep God's big laws better. They thought those extra rules pleased God and made them good people.**

**And most of all, the Pharisees thought God might send the Messiah, the Savior, sooner if everyone was very good, and kept all the little, bitty rules as well as God's big laws. Oh, how they wanted the Messiah to come!**



9. The Pharisees tried very hard to obey all their extra, little rules. They wanted the people to obey them, too. They thought those extra, little rules helped everyone keep God's big laws better. They thought those extra rules pleased God and made them good people. And most of all, the Pharisees thought God might send the Messiah, the Savior, sooner if everyone was very good, and kept all the little, bitty rules as well as God's big laws. Oh, how they wanted the Messiah to come!

**10. But those Pharisees were wrong about so many things! They didn't realize that the Messiah, the Savior, HAD come already. He was right there, living among them, teaching them about God, and doing amazing things by God's power.**

**Can you tell me who God's Savior was? It was Jesus!**





10. But those Pharisees were wrong about so many things! They didn't realize that the Messiah, the Savior, HAD come already. He was right there, living among them, teaching them about God, and doing amazing things by God's power. Can you tell me who God's Savior was? It was Jesus!



**II. And the Pharisees were wrong about something else, too. Instead of becoming good, good, good people when they kept all of these extra little, bitty, rules, these Pharisees became proud, proud, proud people!**

**“We are better than everyone else because we do such a good job obeying all these extra, little, bitty rules,” many of them thought.**

**“We’re so good that we don’t need God’s forgiveness, as other people do. God is pleased with us just the way we are!” they believed.**

**Good, Good, Good**



**Proud, Proud, Proud**



II. And the Pharisees were wrong about something else, too. Instead of becoming good, good, good people when they kept all of these extra little, bitty, rules, these Pharisees became proud, proud, proud people! “We are better than everyone else because we do such a good job obeying all these extra, little, bitty rules,” many of them thought. “We’re so good that we don’t need God’s forgiveness, as other people do. God is pleased with us just the way we are!” they believed.

**12. How very wrong those Pharisees were! All those extra, little, bitty rules they made up didn't please God. Why, even trying very hard to obey all of God's big laws isn't enough to please God!**

**There is only ONE WAY to please God by obeying His laws. Do you know what it is? It is being PERFECT. That's right! It's obeying God's laws ALL THE TIME!**

**Never disobeying ..EVER! Never saying anything wrong or doing anything wrong. Never thinking anything wrong or BEING anything wrong. Do you think that sounds like something those Pharisees could do?**



Perfect?

The LORD

1. Love Me most of all

2. Don't worship fake gods. Worship only Me

3. Love Me by how you talk about Me and how you live

4. Keep a special day to rest and to worship Me

5. Love and obey your mother and father

6. Don't murder people

7. Keep your promise to love only your husband/wife

8. Don't lie

9. Don't take other people's things

10. Be happy with what I give you. Don't be greedy for what others have

# God's Laws

12. How very wrong those Pharisees were! All those extra, little, bitty rules they made up didn't please God. Why, even trying very hard to obey all of God's big laws isn't enough to please God! There is only ONE WAY to please God by obeying His laws. Do you know what it is? It is being PERFECT. That's right! It's obeying God's laws ALL THE TIME! Never disobeying ...EVER! Never saying anything wrong or doing anything wrong. Never thinking anything wrong or BEING anything wrong. Do you think that sounds like something those Pharisees could do?

**13. No, the Pharisees could not be this good. They had “rotten innards”  
--sinful hearts-- just like everyone else. They would never be able  
to please God by trying to be good.**

**And guess what? Neither can we. Why? Because every one of us  
has a sinful heart, too. Every one of us has broken God's laws. We  
all need God's forgiveness for our sins. That is the only way we can  
know and please God. That's the only way we can live with God as  
His people.**





13. No, the Pharisees could not be this good. They had “rotten innards” --sinful hearts-- just like everyone else. They would never be able to please God by trying to be good. And guess what? Neither can we. Why? Because every one of us has a sinful heart, too. Every one of us has broken God's laws. We all need God's forgiveness for our sins. That is the only way we can know and please God. That's the only way we can live with God as His people.

**14. But these poor, proud Pharisees would just not see this. They were SURE that they were already good enough to please God, and they were SURE that all those other people who came to Jesus were not.**

**So, what did Jesus do with these proud men who thought they were so good? Jesus loved them, that's what He did. Jesus wanted to help them, just like He wanted to help everyone else who came to Him.**

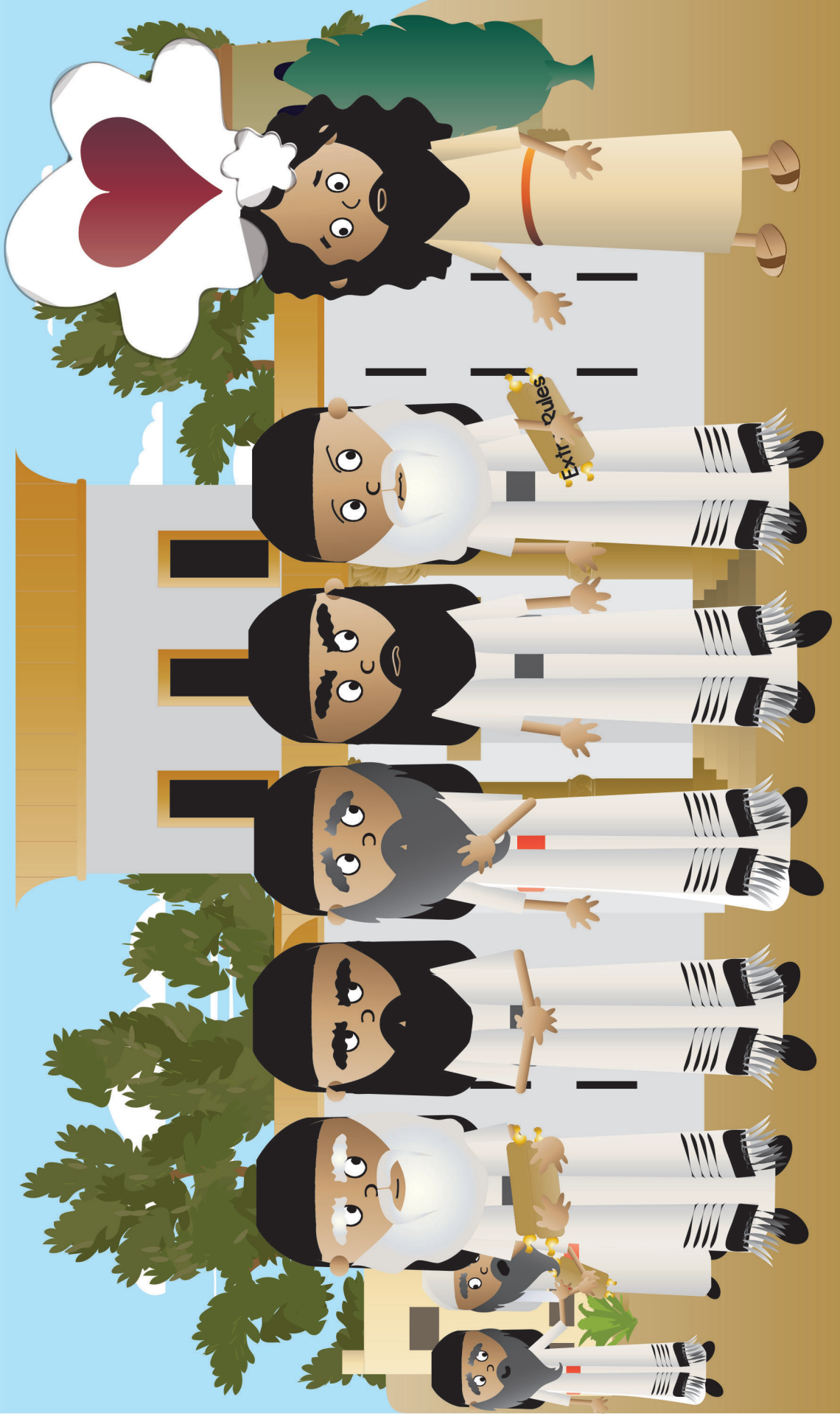

14. But these poor, proud Pharisees would just not see this. They were SURE that they were already good enough to please God, and they were SURE that all those other people who came to Jesus were not. So, what did Jesus do with these proud men who thought they were so good? Jesus loved them, that's what He did. Jesus wanted to help them, just like He wanted to help everyone else who came to Him.

**15. So, Jesus told them a story to help them see that they needed God to save them and forgive them, just like everyone else did. Maybe then they would understand that they were sinners and would ask God for forgiveness. This is the story Jesus told them...**

**“One day, two men went to God’s Temple (the worship place) to pray. One man was a Pharisee. The other man was a tax collector,” Jesus said.**



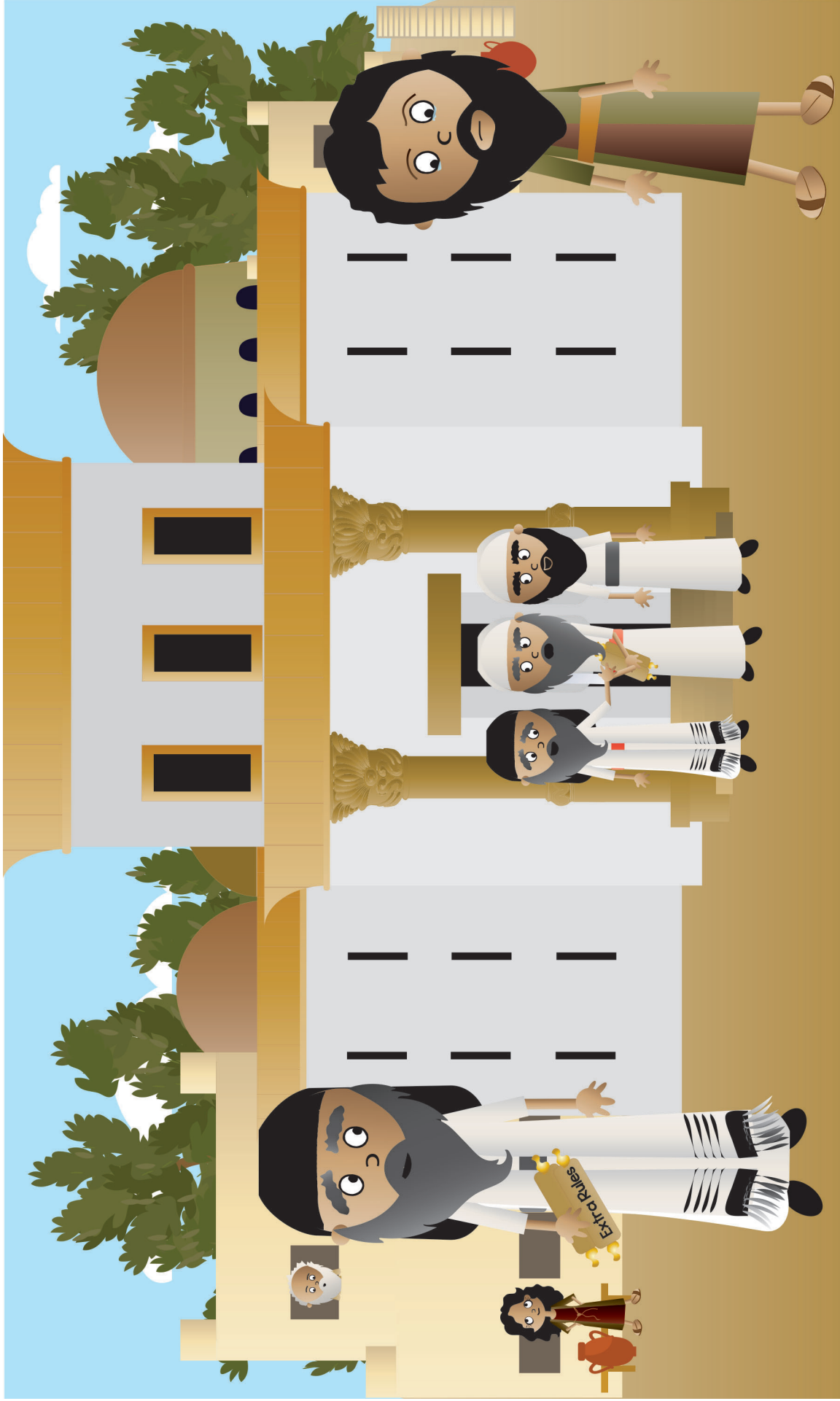

15. So, Jesus told them a story to help them see that they needed God to save them and forgive them, just like everyone else did. Maybe then they would understand that they were sinners and would ask God for forgiveness. This is the story Jesus told them...

“One day, two men went to God’s Temple (the worship place) to pray. One man was a Pharisee. The other man was a tax collector,” Jesus said.



**16. “The Pharisee thought of himself as a very good man who pleased God by obeying God’s laws and the teachers’ extra rules.”**

**“So, he stretched his arms up high and looked up to heaven, and proudly prayed, “God, thank You that I am different from other men. I’m not like that bad, tax collector over there. I don’t do the bad things they do. I am good, good, good. I keep all your laws and all the extra rules of my teachers, too,” he said.**



16. "The Pharisee thought of himself as a very good man who pleased God by obeying God's laws and the teachers' extra rules. So, he stretched his arms up high and looked up to heaven, and proudly prayed, "God, thank You that I am different from other men. I'm not like that bad, tax collector over there. I don't do the bad things they do. I am good, good, good. I keep all your laws and all the extra rules of my teachers, too," he said.

**17. Can you believe that? That Pharisee didn't praise GOD for being good! He only boasted to God about his OWN goodness! That Pharisee wasn't really a good, good, good man at all, was he? No! He was really a proud, proud, proud man!**

**Good, Good, Good**

**Proud, Proud, Proud**

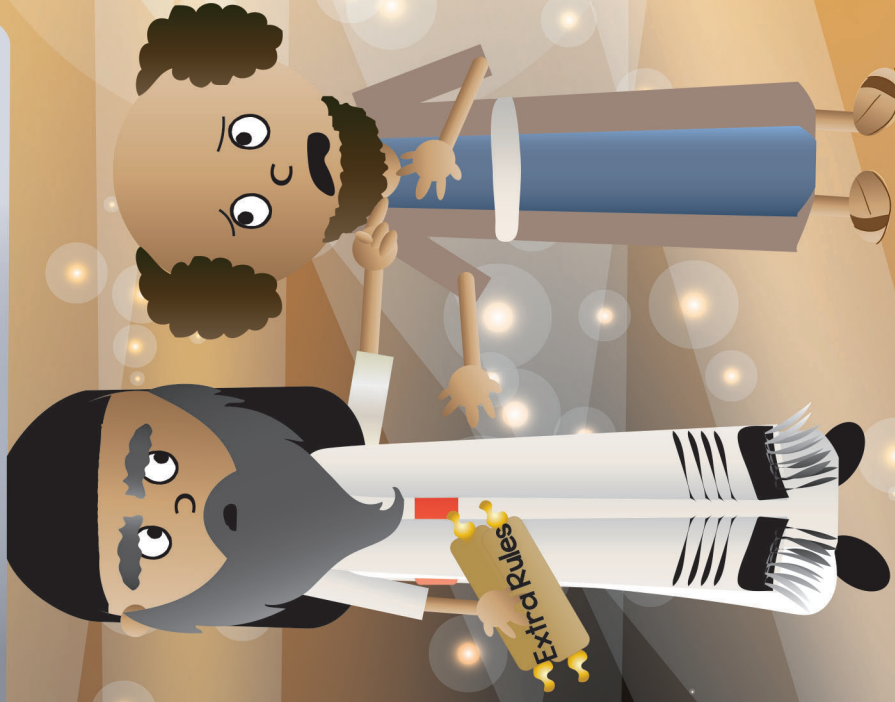

17. Can you believe that? That Pharisee didn't praise GOD for being good! He only boasted to God about his OWN goodness! That Pharisee wasn't really a good, good, good man at all, was he? No! He was really a proud, proud, proud man!

**18. Then, Jesus went on with his story. He told about the other man.**

**“The tax collector came to the Temple knowing he was a bad, bad, bad man. He knew he had “rotten innards” --a sinful heart. He knew the sin in his heart showed in how he lived. He had chosen to disobey God’s good laws. He had chosen to become rich by taking too much money from people.”**





**19. “And when this tax collector prayed to God, it wasn’t boldly and proudly like the Pharisee.**

**No, this man KNEW he had done lots of bad things and he was sad about them. He was sad he had disobeyed God’s laws and treated others so badly. He KNEW he wasn’t right with God; and oh, how he wanted to be!**

**The tax collector was too ashamed of his sins to stretch up his arms or look up to heaven to pray. He looked down at his feet, beat his chest, and cried out to God, “God, have mercy on me! I am so bad. I have disobeyed Your laws. I have a sinful heart. Have mercy on me! Please, forgive my sins!”**



# THE LORD

19. “And when this tax collector prayed to God, it wasn’t boldly and proudly like the Pharisee. No, this man **KNEW** he had done lots of bad things and he was sad about them. He was sad he had disobeyed God’s laws and treated others so badly. He **KNEW** he wasn’t right with God; and oh, how he wanted to be! The tax collector was too ashamed of his sins to stretch up his arms or look up to heaven to pray. He looked down at his feet, beat his chest, and cried out to God, “God, have mercy on me! I am so bad. I have disobeyed Your laws. I have a sinful heart. Have mercy on me! Please, forgive my sins!”

**20. Then, Jesus told the Pharisees listening to Him: “The Pharisee went home feeling proud. He was so sure that his life pleased God, but he was wrong. God is not pleased with proud people who don’t see that they are sinners who need His forgiveness,” Jesus told them.**

**“But the tax collector, who knew he was a sinner, went home forgiven by God,” Jesus said. “God loves to forgive sinners --even very bad sinners-- who confess their sins to Him and humbly ask for His forgiveness,” Jesus told them.**





20. Then, Jesus told the Pharisees listening to Him: “The Pharisee went home feeling proud. He was so sure that his life pleased God, but he was wrong. God is not pleased with proud people who don’t see that they are sinners who need His forgiveness,” Jesus told them. “But the tax collector, who knew he was a sinner, went home forgiven by God,” Jesus said. “God loves to forgive sinners --even very bad sinners-- who confess their sins to Him and humbly ask for His forgiveness,” Jesus told them.



**21. What did the Pharisees think of Jesus' story?**

**Did they learn from it? Did they see that everyone has broken God's laws, even people, like themselves, who tried really hard to be good? Did they, at last, see that no one can ever do enough good things to be proud before God? Did they see their own sins and ask God to forgive them?**



21. What did the Pharisees think of Jesus' story? Did they learn from it? Did they see that everyone has broken God's laws, even people, like themselves, who tried really hard to be good? Did they, at last, see that no one can ever do enough good things to be proud before God? Did they see their own sins and ask God to forgive them?

**22. The Bible doesn't tell us what happened with those Pharisees that day.**

**But, we DO know that later, some of these very important teachers --like Joseph of Arimathea and Nicodemus-- DID turn away from their sins and asked God to forgive them. They put their trust in Jesus as their Savior.**

**And did you know that these two men were the very ones who put Jesus' body in the cave-grave, after He had suffered and died on the cross?**



22. The Bible doesn't tell us what happened with those Pharisees that day. But, we DO know that later, some of these very important teachers --like Joseph of Arimathea and Nicodemus-- DID turn away from their sins and asked God to forgive them. They put their trust in Jesus as their Savior. And did you know that these two men were the very ones who put Jesus' body in the cave-grave, after He had suffered and died on the cross?

**23. How amazed and happy they both must have been when Jesus rose from the dead on the third day!**

**Jesus really was the Messiah, the Savior, God had sent to save His people and forgive their sins! He had beaten sin and death for all who turn away from their sins and trust in Him as their Savior. Jesus can be our Savior, too, if we do this, too. Ask Him to help you!**





23. How amazed and happy they both must have been when Jesus rose from the dead on the third day! Jesus really was the Messiah, the Savior, God had sent to save His people and forgive their sins! He had beaten sin and death for all who turn away from their sins and trust in Him as their Savior. Jesus can be our Savior, too, if we do this. Ask Him to help you!

## DDD 7.2 Simple Story Scenes

# “The Case of the Rotten Innards” Luke 18:9-14

# SOLVED



## Detective Dan's Listening Assignment #1

“Innards” is a funny word that means a person's insides. And in this case, it means a person's heart, meant to love and obey God.

1. Who had a rotten heart and knew it? Who had a rotten heart and DIDN'T know it? Many of the people who came to see Jesus knew they had disobeyed God's laws and were sinners. They knew they needed God's forgiveness. The Pharisees were also sinners with “rotten hearts,” but they didn't know it. They thought they pleased God with all the laws they kept and all the good things they thought they did.

2. What did Jesus want them all to do? Jesus wanted everyone to turn away from their sins, ask God for forgiveness, and trust in Him as their Savior.

**For You and Me:**  
Just like everyone in Jesus' day, we, too, have sinful “rotten” hearts. We all break God's laws, and we need His forgiveness. We can have His forgiveness when we turn away from our sins and trust in Jesus as our Savior. God will forgive our sins and make us His people. Ask God to help you! He loves to answer this prayer!



## Detective Dan's Listening Assignment #2

Romans 3:20-22, HCSB

“For no one will be justified in [God's] sight by the works of the law...But now, apart from the law, God's righteousness has been revealed... God's righteousness through faith in Jesus Christ, to all who believe.”

1. Who thought they were justified (good) in God's sight? Why weren't they? The Pharisees thought they were justified in God's sight because they obeyed God's laws and the extra rules. They weren't justified because no one (except Jesus) obeys God's laws perfectly ---and that's the only way to be justified by obeying God's law.

2. What did Jesus want these people to do? He wanted them to understand that they were sinners who needed to turn to God and ask for His forgiveness. He wanted them to trust in Him as their Savior, so they might be saved from their sins.

**For You and Me:**

Just like the Pharisees, we also cannot be justified (made right with God) by doing good things and trying to obey God's laws. We will never obey them perfectly. We all break God's laws and we need His forgiveness. We can have His forgiveness when we turn away from our sins and trust in Jesus as our Savior. God will forgive our sins and make us His people. Ask God to help you! He loves to answer this prayer!

## DDD 7.2 Simple Story Scenes



What Are God's Laws Like?  
God's Laws Are Perfect...  
they show us that we need God to save us!

# The Gospel



God's laws are perfect. They show us how God requires us to live. But the sad truth is, we all break God's good laws. That's why we all deserve His punishment, and that's why we all need God to save us! Only He can make it possible for us to become His people. And that's exactly what He did through Jesus, His Son.

Jesus came and lived a perfect life. He kept every, single one of God's laws! Then, He offered up His perfect life to God as the full payment for the sins of God's people, when He suffered and died on the cross. Then on Day Three, Jesus rose from the dead in victory. Jesus had beaten sin and death for God's people!

We can be God's people, too, when we turn away from our sins and trust in Jesus as our Savior.

He loves to help us do this. Ask Him!





## DDD 7.2 Simple Story Scenes

# A Prayer

**A** We praise You, God, for being the Giver of Your perfectly good laws.

**C** God, instead of obeying Your good laws, we have all chosen to break them. Sometimes, we don't obey our parents. Sometimes, we lie. Sometimes, we want things that belong to others. We do not always love you most of all. These are only some of the ways we break Your good laws. Oh, how we need a Savior!

**T** Thank You, God, for giving us Your good laws, so we know how to love and obey You. And thank You for sending Jesus to perfectly live out Your laws and to give His life as the perfect payment for the sins of Your people. Thank You that He can be our Savior, too, when we turn away from our sins and trust in Him.

**S** God, work in our hearts. Help us to turn away from disobeying You and trust in Jesus as our own Savior. Help us to know You, love You, and live for You. Help us to learn Your good laws and obey them.

In Jesus' name we pray. Amen.



## DDD 7.2 Simple Story Scenes

# **DEEP DOWN DETECTIVES**



**Simple Story Scenes**

**Unit 7,**

**Bible Truth 3**

## Using Simple Story Scenes as a Curriculum

### Introduce the Key Concept and Bible Verse

Simple Story Scenes give you the basics for the core of your lesson. You can use the overview sheet to introduce and explain the key concept and Bible verse.

### Give the Case Assignment

Give the children a Detective Dan listening assignment. Two are provided. You can add a third using the ideas on the bonus, third take-home sheet, if desired. Each listening assignment, let's you teach the story with a different learning emphasis.

### Show & Tell the Story

Hold up the pictures and tell the story from the story scenes. Alternatively, you can find in the and Pieces section for this unit at [praisefactory.org](http://praisefactory.org), these same listening assignments and story scenes, gospel and ACTS prayer modified for view on a screen. Simply download them or open them online and show through your own monitor (tablet, big screen, whatever).

### Solve the Case

Repeat Detective Dan's listening assignment question and discuss the answer.

### Share the Gospel

Share the gospel tie-in with the kids.

### Close in ACTS Prayer

Pray the ACTS prayer with the kids. If using the curriculum with older children, give them a chance to think up their own ACTS tie-ins to the story, using the one provided as cues/ideas for you.

### Review Time

Give out the take-home sheet (there are three: two that correlates to the two Detective Dan assignments in the Story Scenes, and a bonus third one.) As the children are coloring, use the take-home sheet discussion questions or your own questions to further review and apply the key concepts, Bible verse, and story truths to the children.

### Looking for more?

Online, in the Bits and Pieces section for this unit, you will find review games, crafts, storyboard flannelgraph figures, and audio and sheet music for all of the songs. There are also full lesson plans that offer more of a script and take this curriculum's possibilities to much more depth. Don't forget to tell the parents about the Parents Resources section where they can read through the Story scenes and download take homes with their kids.



**Unit 7: God, the Just and Merciful**

**Unit Big Question (and Answer):** What Are God's Laws Like? God's Laws Are Perfect!

**Unit Bible Verse:** "The law of the LORD is perfect." Psalm 19:7

**Bible Truth 3 Concept: God's Laws Are Perfect... They Tell Us How to Love God and Others!**

The LORD is the one, true God. He deserves our love. He made us to love Him more than anything else. Loving God is the most delightful thing we can do. God gave us His laws so we can know how to love Him. When we obey His laws, we are living out our love for Him.

God made us not just to love Him, but also to love each other. He gave His laws so we can know how to love each other. He tells us to treat others in the same loving way we want others to treat us. When we obey God's laws, we are living out God's love for others. And, we are showing them a little bit of what God is like, that they might seek to know and love Him, too.

Obeying God's laws is not just the right way to live. It is also the happiest way to live with God and with other people. God can help us obey His laws and live in love when we turn away from our sins and trust in Jesus as our Savior. He gives us a new heart filled with His Holy Spirit and helps us to live in love as He wants us to.

**Bible Truth 3 Bible Verse: Matthew 22:37-40, ESV**

"You shall love the Lord your God with all your heart and with all your soul and with all your mind. This is the great and first commandment. And a second is like it: You shall love your neighbor as yourself. On these two commandments depend all the Law and the Prophets."

**Learn a Little:** "Love the Lord your God with all your heart, soul and mind... Love your neighbor as yourself."

**Meaning**

God has given us many laws in the Bible. It's good to know them all. But Jesus tells us in these verses that the purpose behind all of God's laws is to love God most of all, and to love others as we love ourselves. When we live out all His good laws, we are loving God and love others as He wants us to.

**Bible Truth 3 ACTS Prayer**

- A** We praise You, God, for being the Giver of Your perfectly good laws that show us how to love You and others.
- C** God, many times, we do not obey Your good laws. Many times, we do not love You or others as Your laws tell us to. We need a Savior!
- T** Thank You, God, for giving us Your good laws that show us how to love You and others. Thank You for sending Your Holy Spirit to live in our hearts when we trust in Jesus as our Savior. He helps us to obey Your good and loving laws.
- S** God, work in our hearts. Help us to turn away from our sins and trust in Jesus as our Savior. Send Your Holy Spirit to live inside our hearts and help us to love You and others as You want us to.  
In Jesus' name we pray, Amen.

**Bible Truth 3 Story****The Case of the Do's and Don'ts**

*Matthew 5,6,22*

**Songs Used in Bible Truth 3**

Big Q & A 7 Song

Big Question 7 Song: What Are God's Laws Like?

Big Question 7 Bible Verse Song: The Law of the Lord Psalm 19:7, ESV

*Extra Big Question 7 Bible Verse Song: The Law of the Lord Is Perfect Psalm 19:7, ESV (full version)*

Big Question 7 Hymn: Holy Bible, Book Divine

Big Question 7 Praise Song: The Best Book to Read Is the Bible

Bible Truth 3 Bible Verse Song: Love the Lord Matthew 22:37-40, ESV

listen to or download songs for free at <https://praisefactory.org>: Deep Down Detectives Music page

# “The Case of the Do’s and Don’ts” Matthew 5,6,22

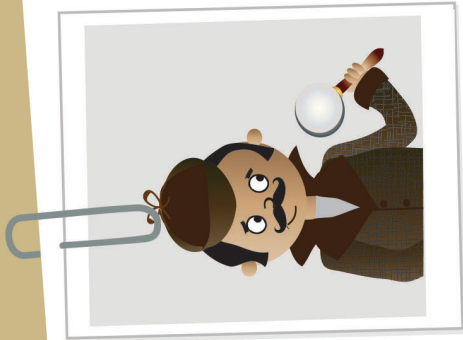

## Detective Dan’s Listening Assignment #1

1. Who made up extra, little rules of do’s and don’ts?
2. What did Jesus think of those extra do’s and don’ts?  
What did Jesus say God’s real laws help people to do?



## Detective Dan’s Listening Assignment #2

### Matthew 22:37,39, ESV

“Love the Lord your God with all your heart, soul and mind... Love your neighbor as yourself.”

1. Which laws did Jesus tell people to obey?
2. Who is the only person to obey God’s laws perfectly?  
How did He share His perfect life with us?

(more listening and discussion questions are included in the curriculum at [praisefactory.org](http://praisefactory.org))

**I. Rules! Rules! Rules! So many rules for God's people to keep! "Do this! Don't do that!" the teachers in Jesus' day (the Pharisees) taught the people.**

**Of course, there were the Ten, Big Laws (the Ten Commandments) that God had given them through Moses. But there were so many more rules than that.**

**Can you guess how many laws the Pharisees counted in God's Word for everyone to obey? Twenty? Fifty? Surely, not a hundred!**



**I. Rules! Rules! Rules! So many rules for God's people to keep! "Do this! Don't do that!" the teachers in Jesus' day (the Pharisees) taught the people. Of course, there were the Ten, Big Laws (the Ten Commandments) that God had given them through Moses. But there were so many more rules than that. Can you guess how many laws the Pharisees counted in God's Word for everyone to obey? Twenty? Fifty? Surely, not a hundred!**



**2. It was more than any of those guesses! It was 613! There were 248 “DO” laws and 365 “DON’T” laws.**

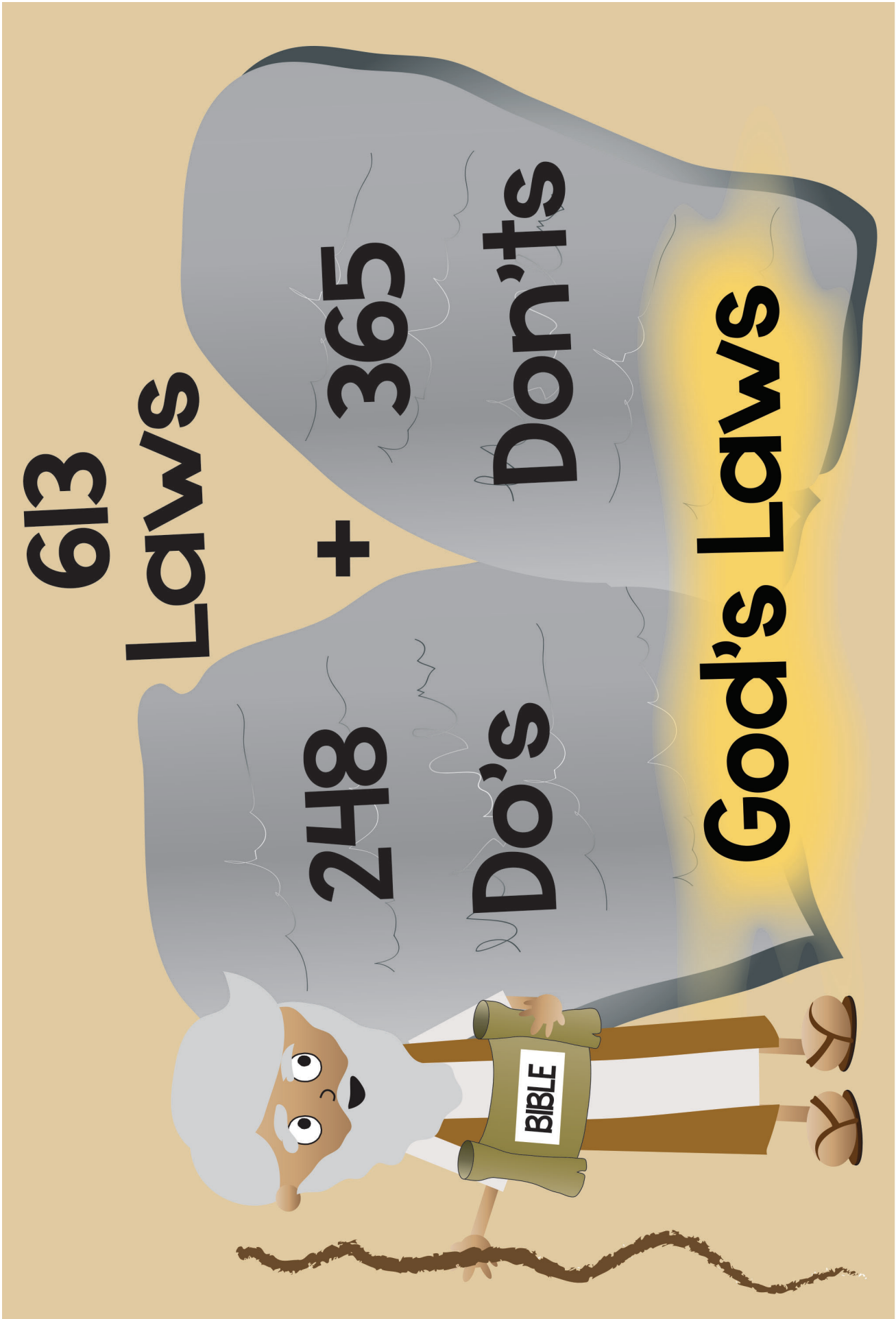

2. It was more than any of those guesses! It was 613! There were 248 "DO" laws and 365 "DON'T" laws.

**3. But soon, those 613 laws turned into even more, as the teachers came up with extra ways they wanted God's people to live them out.**

**They came up with extra "DO's" like: "DO say a special prayer as you wash your hands when you wake up in the morning, or you won't please God." And extra DON'T's" like: "DON'T use the same spoon to stir milk and cook meat, or you won't please God."**

**What a lot of extra rules! Oh, how they weighed down the people!  
Who could keep all these rules!**



3. But soon, those 613 laws turned into even more, as the teachers came up with extra ways they wanted God's people to live them out. They came up with extra "DO's" like: "DO say a special prayer as you wash your hands when you wake up in the morning, or you won't please God." And extra DON'T's" like: "DON'T use the same spoon to stir milk and cook meat, or you won't please God." What a lot of extra rules! Oh, how they weighed down the people! Who could keep all these rules!

**4. But then, Jesus came. He wasn't like any of the other teachers. He healed sick people without using any medicine! He brought dead people back to life again! He even forgave people's sins! Jesus simply spoke and God's power did these wonderful things through Him.**



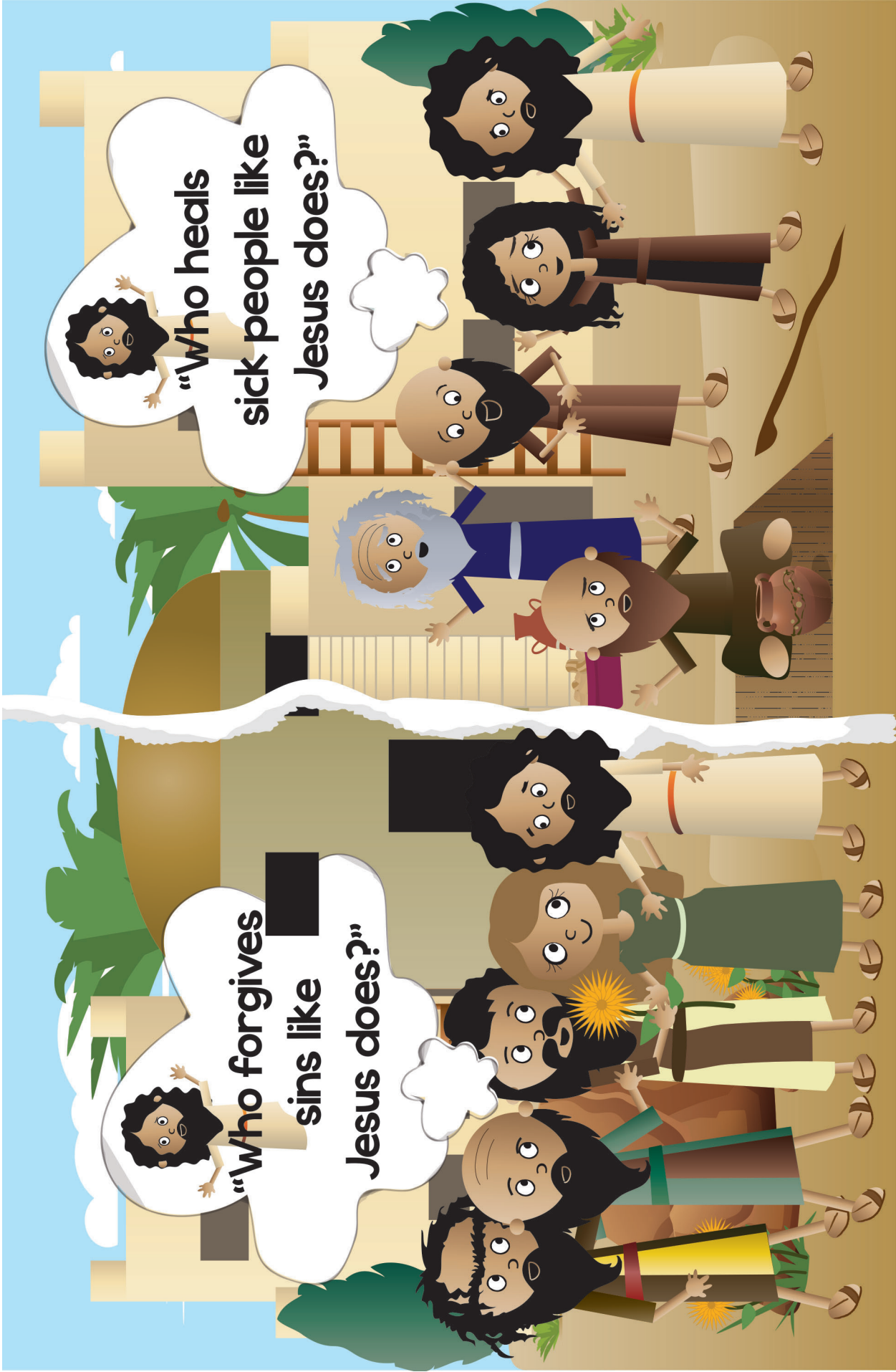

4. But then, Jesus came. He wasn't like any of the other teachers. He healed sick people without using any medicine! He brought dead people back to life again! He even forgave people's sins! Jesus simply spoke and God's power did these wonderful things through Him.

**5. Jesus did other amazing things, too.**

**One time, Jesus said, “Be still,” to the strong winds and the big waves of a huge storm. Right away, the storm stopped. Another time, Jesus fed a huge, hungry crowd of people with just two fish and five loaves of bread. Wow!**



5. Jesus did other amazing things, too. One time, Jesus said, "Be still," to the strong winds and the big waves of a huge storm. Right away, the storm stopped. Another time, Jesus fed a huge, hungry crowd of people with just two fish and five loaves of bread. Wow!

**6. The news about Jesus spread quickly. Soon, many people were coming to Jesus.**

**They came to have Him heal their sick family and friends. They came to see Him do amazing things. And, they came to hear what He had to say about God and His laws.**

**Would Jesus be like all the other teachers? Would He tell them to keep all those Do's and Don'ts? Would He give them lots of extra rules like the Pharisees did?**

**Jesus answered all of their questions.**





**6. The news about Jesus spread quickly. Soon, many people were coming to Jesus. They came to have Him heal their sick family and friends. They came to see Him do amazing things. And, they came to hear what He had to say about God and His laws. Would Jesus be like all the other teachers? Would He tell them to keep all those Do's and Don'ts? Would He give them lots of extra rules like the Pharisees did? Jesus answered all of their questions.**



**7. One day, Jesus and a huge crowd of people climbed up, up, up, up a grassy mountain above the Sea of Galilee. When they reached the top, Jesus sat down and began to teach them about God's laws.**

**“God's laws are very important,” Jesus told the people. “God's laws will last until the end of time. I have not come to get rid of even one of God's good laws,” He said.**



7. One day, Jesus and a huge crowd of people climbed up, up, up a grassy mountain above the Sea of Galilee. When they reached the top, Jesus sat down and began to teach them about God's laws. "God's laws are very important," Jesus told the people. "God's laws will last until the end of time. I have not come to get rid of even one of God's good laws," He said.

**8. “Your teachers, the Pharisees, try to please God by adding lots of extra, little rules to God’s good laws. They think all this rule-keeping will make them right with God, but it’s not enough. You need something more than all their extra, little rules to please God. You will need a better righteousness than theirs, if you want to be God’s people,” Jesus told them.**



8. “Your teachers, the Pharisees, try to please God by adding lots of extra, little rules to God’s good laws. They think all this rule-keeping will make them right with God, but it’s not enough. You need something more than all their extra, little rules to please God. You will need a better righteousness than theirs, if you want to be God’s people,” Jesus told them.

**q. Oh, no! This didn't sound good at all! The Pharisees worked so hard to keep all 613 laws in the Bible! And, they made up all those hundreds of extra, little rules, to try to please God, too.**

**How could ANYONE be better than the Pharisees? Was Jesus going to give them even MORE rules to live by? It sure sounded that way.**





q. Oh, no! This didn't sound good at all! The Pharisees worked so hard to keep all 613 laws in the Bible! And, they made up all those hundreds of extra, little rules, to try to please God, too. How could ANYONE be better than the Pharisees? Was Jesus going to give them even MORE rules to live by? It sure sounded that way.

**10. No, Jesus was not. “Your teachers are wrong about their extra, little rules. They just weigh down people. They don’t help anyone live as God wants them to live,” Jesus said.**

**“I have come to fulfill God’s law. I will teach you how to really live out God’s laws to please Him,” He told the crowds. “The “Do’s” and “Don’ts” in God’s Word are all about how we show love to God and others. These laws start in the heart with love, and they tell us how God wants us to live out that love with our whole lives,” Jesus explained.**



10. No, Jesus was not. “Your teachers are wrong about their extra, little rules. They just weigh down people. They don’t help anyone live as God wants them to live,” Jesus said. “I have come to fulfill God’s law. I will teach you how to really live out God’s laws to please Him,” He told the crowds. “The “Do’s” and “Don’ts” in God’s Word are all about how we show love to God and others. These laws start in the heart with love, and they tell us how God wants us to live out that love with our whole lives,” Jesus explained.

**11. “Some people LOOK like they obey God’s laws, but really, they are still breacking them,” Jesus told the people. “They do the right thing on the outside, but in their hearts, they are angry or jealous or hateful.”**

**“God doesn’t just look on the outside. He sees inside every heart. He knows the sin that is hiding there. He knows when you are angry or jealous or hateful. What goes on inside your heart breaks God’s laws, too,” Jesus explained.**





II. “Some people **LOOK** like they obey God’s laws, but really, they are still breaking them,” Jesus told the people. “They do the right thing on the outside, but in their hearts, they are angry or jealous or hateful. God doesn’t just look on the outside. He sees inside every heart. He knows the sin that is hiding there. He knows when you are angry or jealous or hateful. What goes on inside your heart breaks God’s laws, too,” Jesus explained.



**12. The people listened to Jesus and were amazed! Jesus wasn't at all like the other teachers they had heard before. He didn't just give them lots of extra, little rules. He helped them see that God's laws show them how to truly love God and others.**



12. The people listened to Jesus and were amazed! Jesus wasn't at all like the other teachers they had heard before. He didn't just give them lots of extra, little rules. He helped them see that God's laws show them how to truly love God and others.

**13. As Jesus later said: “Love the LORD with all your heart, your mind, and your strength. Love others --even your enemies-- as much as you love yourself. Do to them only what you want them to do to you. If you do love the LORD and love others like this, you will be obeying all of God’s laws, because that’s what God’s laws are really all about.”**

**How about that! All of those 10 Commandments, and even all of those 613 laws, really added up to only two: love the LORD and love others. Amazing!**

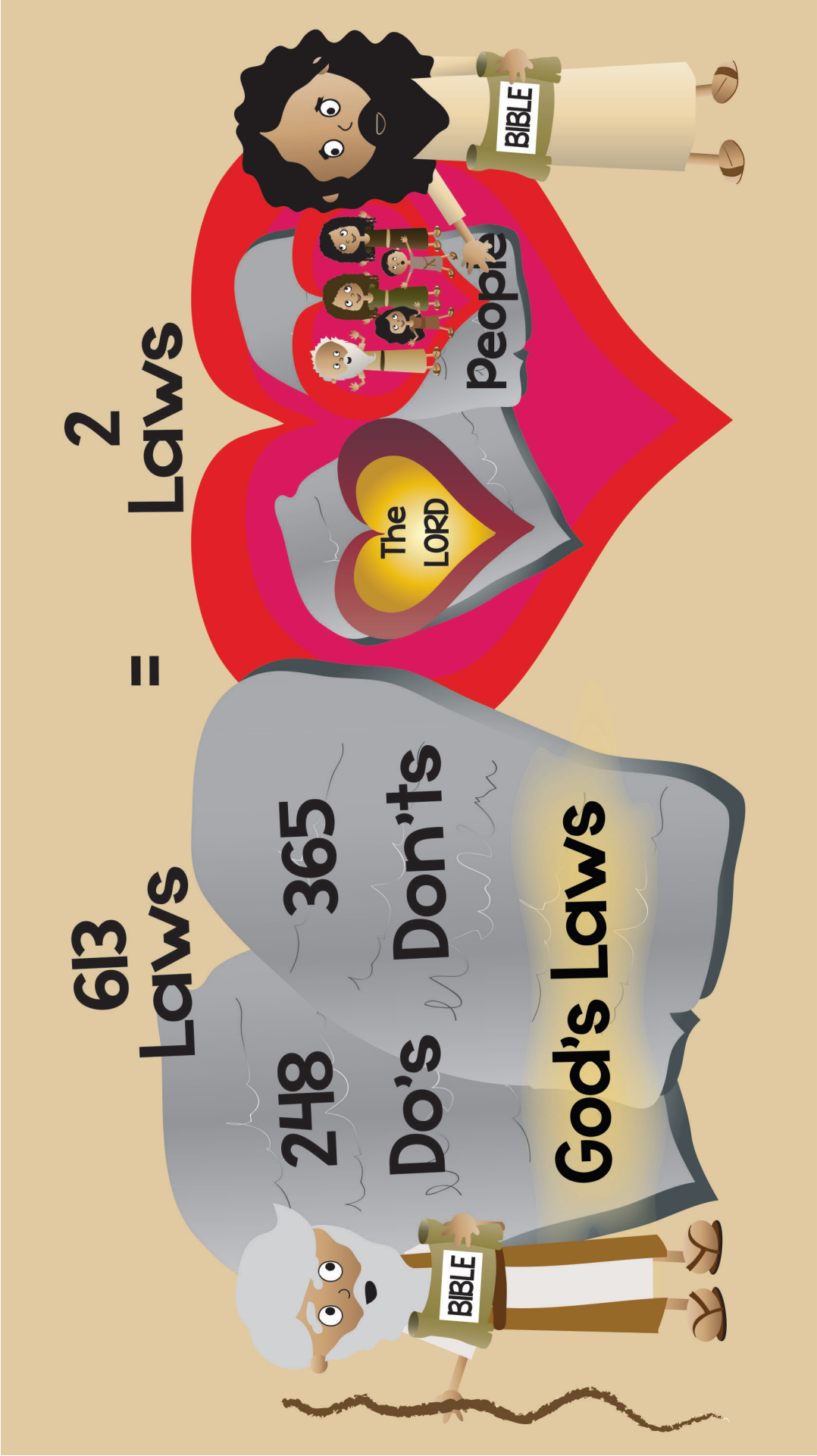

13. As Jesus later said: "Love the LORD with all your heart, your mind, and your strength. Love others --even your enemies-- as much as you love yourself. Do to them only what you want them to do to you. If you do love the LORD and love others like this, you will be obeying all of God's laws, because that's what God's laws are really all about."

How about that! All of those 10 Commandments, and even all of those 613 laws, really added up to only two: love the LORD and love others. Amazing!

**14. I wonder what people were thinking as climbed down the mountain at the end of the day. Jesus had given them less rules to follow, but they were much harder than all those 613 “Do’s” and “Don’ts” in God’s Word, and all those extra, little rules of the Pharisees.**



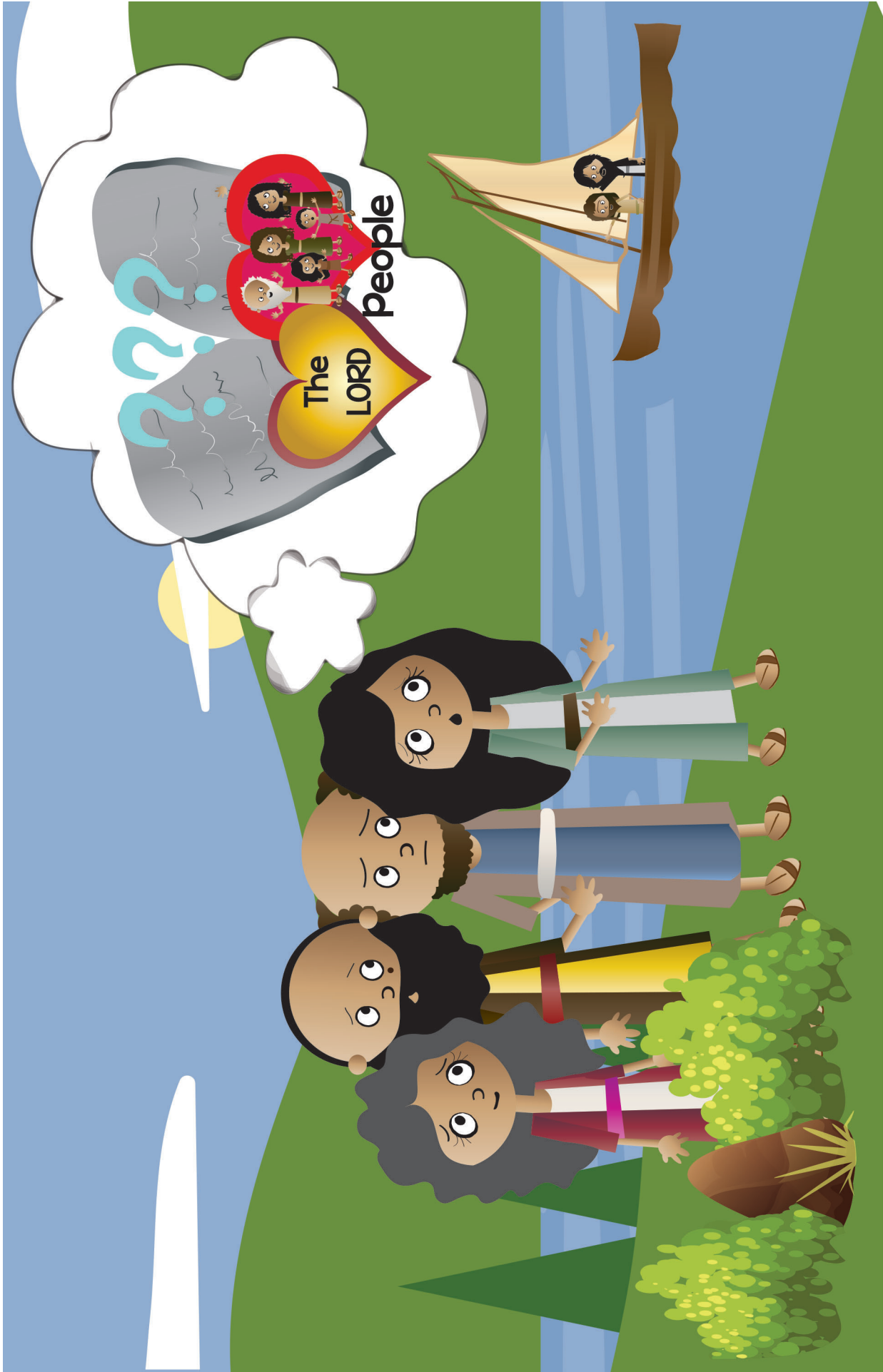

14. I wonder what people were thinking as climbed down the mountain at the end of the day. Jesus had given them less rules to follow, but they were much harder than all those 613 “Do’s” and “Don’ts” in God’s Word, and all those extra, little rules of the Pharisees.

**15. Anyone could remember to wash their hands when they woke up in the morning, or to use a different spoon when they stirred the milk and cooked the meat.**

**But loving God and others from the heart... that was so hard! How could they ever keep their hearts from being angry or jealous or hateful towards others? How could they really love God most of all? Could they ever really obey God's laws? Could they ever please God and love God's people, if this was how they must live? There seemed to be no hope.**

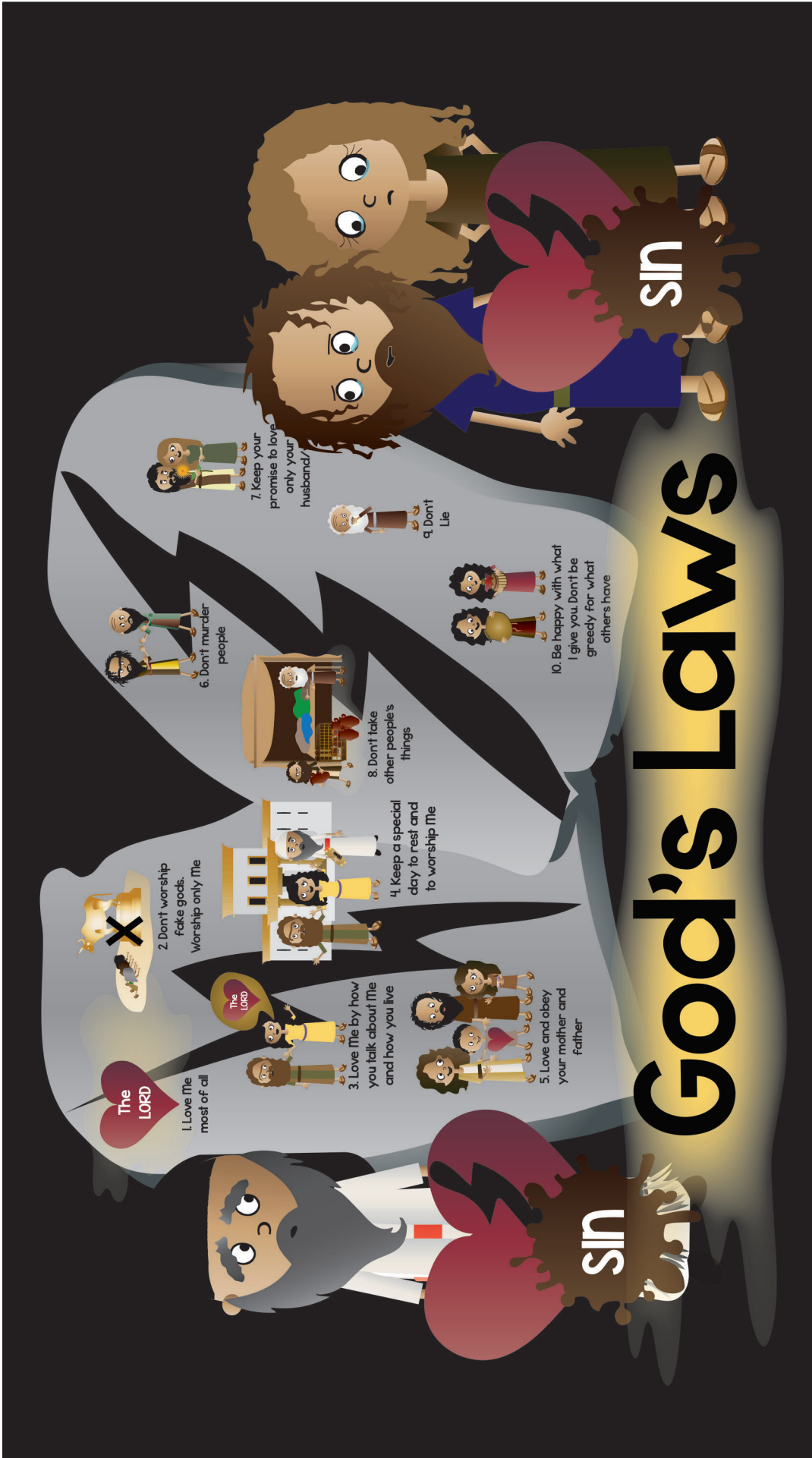

# God's Laws

15. Anyone could remember to wash their hands when they woke up in the morning, or to use a different spoon when they stirred the milk and cooked the meat. But loving God and others from the heart... that was so hard! How could they ever keep their hearts from being angry or jealous or hateful towards others? How could they really love God most of all? Could they ever really obey God's laws? Could they ever please God and love God's people, if this was how they must live? There seemed to be no hope.

**16. Well, there WAS no hope, if they had to obey God's good laws of love on their own.**

**But praise God, they did NOT! That's why God sent Jesus! Not just to TELL the people what it really means to live out God's laws. But, to DO it, HIMSELF!**

**Yes, Jesus lived out God's laws perfectly every day He lived here on earth. He always loved God most of all. He always loved people. In everything He thought, and said, and did, Jesus fulfilled God's law completely. He pleased God with His whole life. Jesus could do this because He was the perfect Son of God. He truly loved God, His Father, and He had come to be our Savior.**



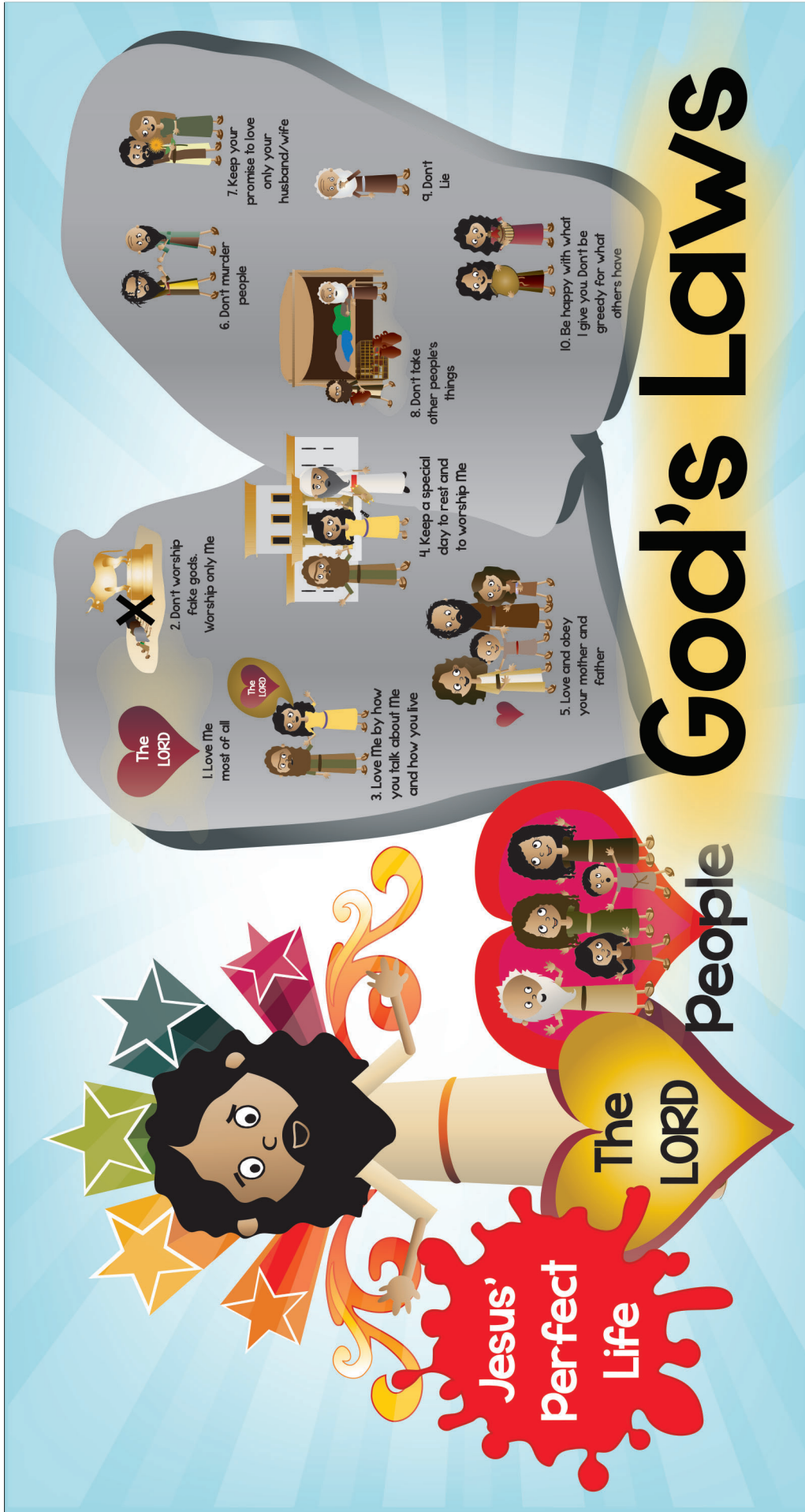

16. Well, there WAS no hope, if they had to obey God's good laws of love on their own. But praise God, they did NOT! That's why God sent Jesus! Not just to TELL the people what it really means to live out God's laws. But, to DO it, HIMSELF! Yes, Jesus lived out God's laws perfectly every day He lived here on earth. He always loved God most of all. He always loved people. In everything He thought, and said, and did, Jesus fulfilled God's law completely. He pleased God with His whole life. Jesus could do this because He was the perfect Son of God. He truly loved God, His Father, and He had come to be our Savior.



**17. And what did the Pharisees think about what Jesus taught? They did NOT like it! They did not like that Jesus said He was God's Son. They did not like what He said about them and all their extra, little rules. And so, the Pharisees and other enemies worked together to get rid of Jesus. They nailed Him to a cross to suffer and die, and to get rid of Him, once and for all.**

**But God was up to good, even in the bad plans of Jesus' enemies. For on that cross, Jesus offered up His perfect life as the full payment for the sins of all who would ever turn away from their sins and trust in Him as their Savior. He took their punishment and gave them His perfect life. Now, they could please God. Not with their own lives, but with His!**



17. And what did the Pharisees think about what Jesus taught? They did NOT like it! They did not like that Jesus said He was God's Son. They did not like what He said about them and all their extra, little rules. And so, the Pharisees and other enemies worked together to get rid of Jesus. They nailed Him to a cross to suffer and die, and to get rid of Him, once and for all.

But God was up to good, even in the bad plans of Jesus' enemies. For on that cross, Jesus offered up His perfect life as the full payment for the sins of all who would ever turn away from their sins and trust in Him as their Savior. He took their punishment and gave them His perfect life. Now, they could please God. Not with their own lives, but with His!

**18. Jesus died and was buried in a cave-grave that sad day, but did He stay there? No, He did not! On the third day, He rose from the dead. Jesus had really beaten sin and death for God's people!**

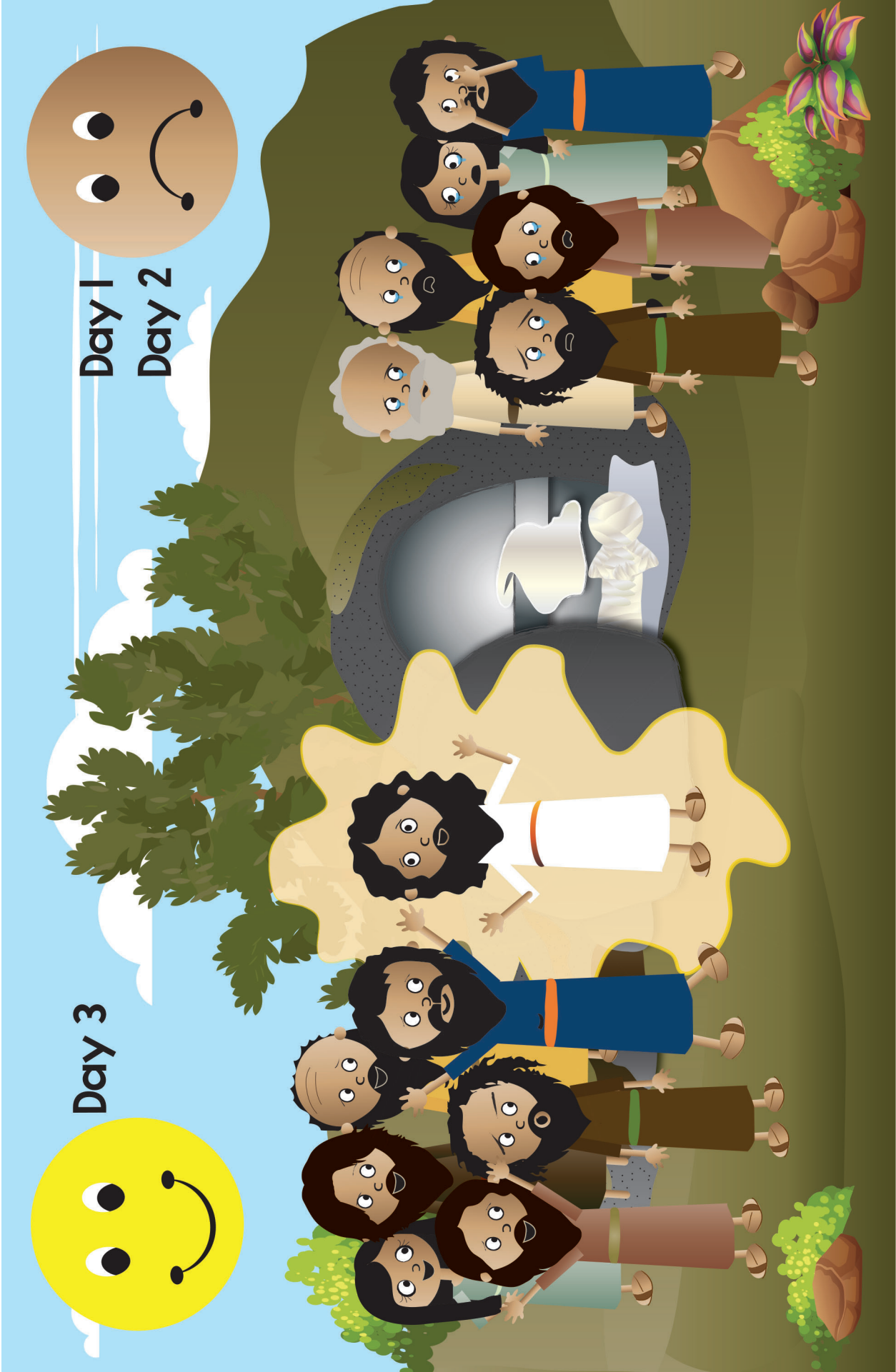

18. Jesus died and was buried in a cave-grave that sad day, but did He stay there? No, He did not! On the third day, He rose from the dead. Jesus had really beaten sin and death for God's people!

**19. After Jesus rose from the dead, He appeared to His followers and taught them more about God's good plans. Best of all, He told them about God's special gift to help them live out God's law from their hearts. Do you know what that special gift was?**





**19. After Jesus rose from the dead, He appeared to His followers and taught them more about God's good plans. Best of all, He told them about God's special gift to help them live out God's law from their hearts. Do you know what that special gift was?**

## **20. It was the Holy Spirit!**

**“I am going back home to heaven, but I will send you the Holy Spirit to live in your hearts,” Jesus told His followers. “He will fill your hearts with love. He will help you love God most of all. He will help you love others, too. And He will stay with you your whole lives until the day you come home to live with Me forever,” Jesus promised them.**



20. It was the Holy Spirit! "I am going back home to heaven, but I will send you the Holy Spirit to live in your hearts," Jesus told His followers. "He will fill your hearts with love. He will help you love God most of all. He will help you love others, too. And He will stay with you your whole lives until the day you come home to live with Me forever." Jesus promised them.

**21. And sure enough, not long after Jesus went up to heaven, He did send the Holy Spirit to live in the hearts of God's people! How they praised God! How happy they were! God had been so good to them through Jesus.**

**Jesus had lived a perfect life of love and given it to them, so they could be God's people. He had sent the Holy Spirit to live inside their hearts for the rest of their lives. He would change their hearts and help them to obey God's laws and love God and others.**





21. And sure enough, not long after Jesus went up to heaven, He did send the Holy Spirit to live in the hearts of God's people! How they praised God! How happy they were! God had been so good to them through Jesus. Jesus had lived a perfect life of love and given it to them, so they could be God's people. He had sent the Holy Spirit to live inside their hearts for the rest of their lives. He would change their hearts and help them to obey God's laws and love God and others.



**22. And, how God's people looked forward to the day when they will go to live with God forever! Then, God will make all things new, even their hearts. Then, they will love God and each other perfectly.**

**And at last, God's laws will be perfectly fulfilled, even in them! We can become God's people, too, when we turn away from our sins and trust in Jesus as our Savior.**



22. And, how God's people looked forward to the day when they would go to live with God forever! Then, God will make all things new, even their hearts. Then, they will love God and each other perfectly. And at last, God's laws will be perfectly fulfilled, even in them! We can become God's people, too, when we turn away from our sins and trust in Jesus as our Savior.

### DDD 7.3 Simple Story Scenes

# “The Case of the Do’s and Don’ts” Matthew 5,6,22

# SOLVED



## Detective Dan’s Listening Assignment #1

1. Who made up extra, little rules of do’s and don’ts? The pharisees.
2. What did Jesus think of those extra do’s and don’ts? What did Jesus say God’s real laws help people to do? Jesus knew those do’s and don’ts weren’t what pleased God. Jesus said God’s real laws help people love God most of all and love others.

**For You and Me:**  
None of us can ever obey God’s laws well enough to please God or to truly love others as God wants us to. Only keeping God’s laws perfectly can do that, and we are all lawbreakers! Our only hope is to turn away from our sins and trust in Jesus as our Savior. He is the only way we can please God. God can work in our hearts and help us to better love others as He wants us to. Ask Him to help you. He loves to answer this prayer!



## Detective Dan’s Listening Assignment #2

Matthew 22:37,39, ESV

“Love the Lord your God with all your heart, soul and mind... Love your neighbor as yourself.”

1. Which laws did Jesus tell people to obey? God’s laws.
2. Who is the only person to obey God’s laws perfectly? How did He share His perfect life with us? Jesus. He gave it up on the cross as the full payment for the sins of God’s people when He suffered and died on the cross.

**For You and Me**

How amazing that Jesus obeyed God’s laws perfectly! It’s even more amazing that He offers to share His perfect life with us, that we might be saved! This is His promise to all who turn away from their sins and trust in Him as their Savior. Ask Him to help you do this. He loves to answer this prayer!

### DDD 7.3 Simple Story Scenes



What Are God's Laws Like?  
God's Laws Are Perfect...

They Tell Us How to Love God and Others!

# The Gospel



God's laws tell us how to love God and others, but we are all lawbreakers. We do not love as we should. God would be fair to give us the punishment we deserve for breaking His laws, but He is so rich in mercy. He sent His Son, Jesus, to be our Savior. Jesus obeyed God's laws, and loved God and others perfectly.

On the cross, Jesus suffered and died, giving His perfect life as the full payment for the sins of God's people. On the third day, Jesus rose from the dead, beating sin and death for them.

Now, all who turn away from their sins and trust in Him as their Savior can be God's people. They will know God in their hearts, now. And one day, they will go to live with Him forever.

We can be God's people when we turn from our sins and trust in Jesus as our Savior.



### DDD 7.3 Simple Story Scenes

# A Prayer

A We praise You, God, for being the Giver of Your perfectly good laws. They tell us how to love You and love others.

C God, many times we do not obey Your good laws. Many times, we do not love You or others as Your laws tell us to. We need a Savior!

T Thank You, God, for giving us Your good laws that show us how to love You and others. Thank You for sending Your Holy Spirit to live in our hearts, when we trust in Jesus as our Savior. He helps us to obey Your good and loving laws.

S God, work in our hearts. Help us to turn away from our sins and trust in Jesus as our Savior. Send Your Holy Spirit to live inside our hearts and help us to love You and others as You want us to.

In Jesus' name we pray. Amen.



### DDD 7.3 Simple Story Scenes



# **DEEP DOWN DETECTIVES**



**Take-Home Sheets**





**CAN YOU GUESS BIBLE TRUTH!**  
**What Are God's Laws Like?**  
**God's Laws Are Perfect...**

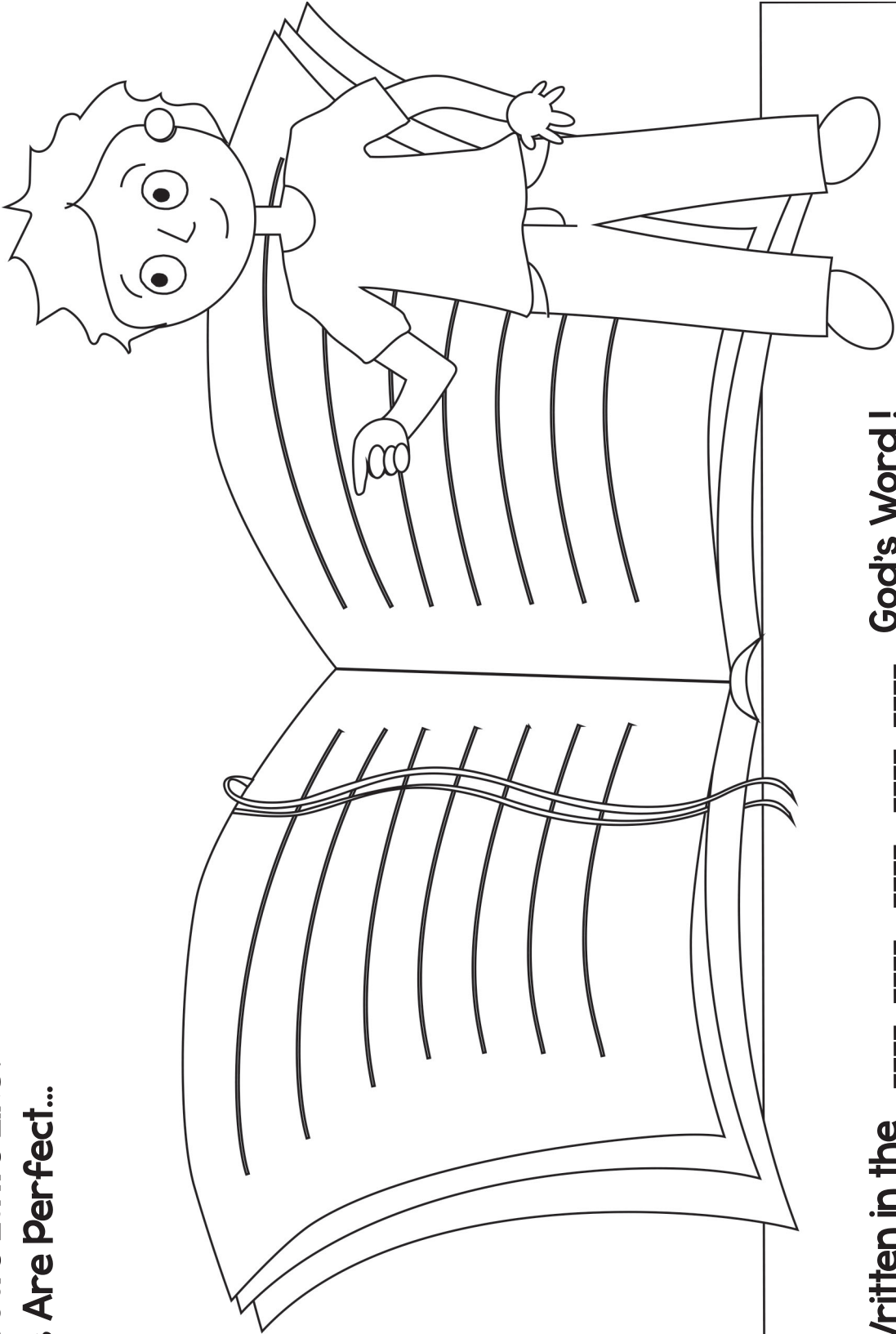

**They Are Written in the ----- God's Word!**

**HINT: "What is the name of God's Word? It starts with an "B."**

# Deep Down Detective Devotion: Unit 7, Bible Truth 1, Lesson 1



## Big Question 7: What Are God's Laws Like?

**Answer:** God's Laws Are Perfect... They Are Written in the Bible, God's Word!

## Bible Truth 1 Meaning

A law is big rule that we are supposed to obey. God told His laws to godly people long ago. These people wrote them down in the Bible, God's Word, so everyone can know them. God's Holy Spirit helped them write them down just right. God's laws are the most important laws of all. They are rules that God wants everyone to keep. That's why God's people take time to learn God's laws and ask Him to help them obey them. They love God and want to please Him. They want to show the world what God is like by living the way He wants us to live.

## How do I know this is true? The Bible tells me so!

"Hear, O Israel, the statutes and the rules that I speak in your hearing today, and you shall learn them and be careful to do them... You shall have no other gods before me. You shall not make for yourself a carved image. You shall not bow down to them or serve them... You shall not take the name of the LORD your God in vain... Observe the Sabbath day, to keep it holy... Honor your father and your mother... You shall not murder. And you shall not commit adultery. And you shall not steal. And you shall not bear false witness... And you shall not covet... anything that is your neighbor's."

--- Deuteronomy 5:1,7-21, ESV

## Some Questions for You

1. What is a law? *A big rule that we are supposed to obey.*
2. What are the most important laws of all? *God's laws.*
3. Who is supposed to obey God's laws? *Everyone.*
4. What kind of people did God tell His laws to write down? *Godly people --people who loved and obeyed Him.*
5. Did the godly people write down God's laws the way He wanted them to? *Yes, they wrote them down exactly right!*
6. Who helped the godly people write God's laws down just right? *The Holy Spirit, working in their heart.*
7. What do God's people take time to learn? *Why? God's laws, because they want to love God and please Him in how they live.*
8. What do God's people want to show the world by living by God's rules? *They want to show the world what God is like.*
9. How can we become God's people? *By turning away from our sins and trusting in Jesus as our Savior. Ask Him to help you do this! He loves to help us!*

## Let's Pray!

- A** We praise You, God, for being the Giver of Your perfectly good laws.
- C** God, we confess that we break Your good laws. Sometimes, we do not obey our parents. Sometimes, we lie. Sometimes, we want things that belong to others. You made us to be law keepers, but we are all lawbreakers. We need a Savior!
- T** Thank You for giving us Your good laws, so we know how to love and obey You. Thank You for making sure they were written down just right in Your Word, the Bible. Thank You for sending Jesus to keep Your laws perfectly and make the way for people like us to be forgiven.
- S** God, work in our hearts. Help us to turn away from our sins and trust in Jesus as our Savior. Help us to learn Your good laws and obey them. Help us to love You by living for You and keeping Your good laws. In Jesus' name we pray, Amen.

## Let's Sing about What We're Learning!

**Big Q & A 7 Song** from *Deep Down Detectives ESV Songs 7, track 12*  
(adapted version of "The Farmer in the Dell")

What are God's laws like?  
What are God's laws like?  
What are God's laws like?  
God's laws are perfect!

**Big Question 7 Action Rhyme Song** from *Deep Down Detectives ESV Songs 7, track 13*

### Refrain:

What are God's laws like?  
What are they like?  
God's laws are perfect!  
God's laws are perfect!  
What are God's laws like?  
What are they like?  
God's laws are like Him,  
They are good and just.

### Verse 1

God is our Creator,  
He's in charge of the whole world.  
He gave us laws to live by,  
They are written in His Word.  
*Refrain*

### Verse 2

God's laws are the best way,  
For us all to live,  
God calls us to obey them,  
To reflect His righteousness. *Refrain*

# I AM LORD

The LORD

1. Love Me most of all

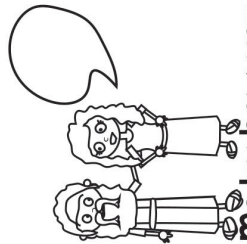

3. Love Me by how you talk about Me and how you live

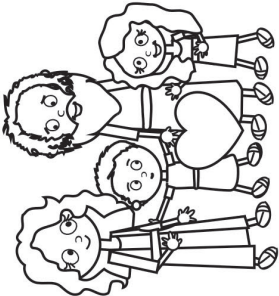

5. Love and obey your mother and father

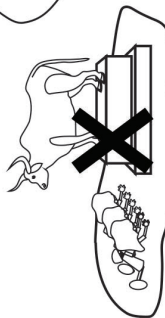

2. Don't worship fake gods. Worship only Me



4. Keep a special day to rest and to worship Me

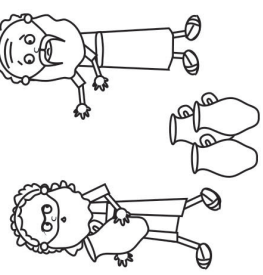

8. Don't take other people's things

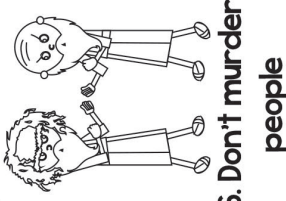

6. Don't murder people

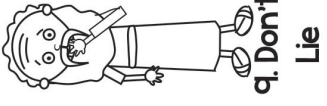

7. Keep your promise to love only your husband/wife

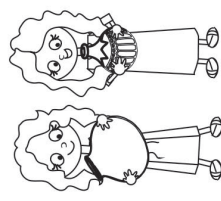

10. Be happy with what I give you. Don't be greedy for what others have

"Hear, O Israel, the statutes and the rules that I speak in your hearing today, and you shall learn them and be careful to do them... You shall have no other gods before me. You shall not make for yourself a carved image. You shall not bow down to them or serve them... You shall not take the name of the LORD your God in vain... Observe the Sabbath day, to keep it holy... Honor your father and your mother... You shall not murder. And you shall not commit adultery. And you shall not steal. And you shall not bear false witness... And you shall not covet... anything that is your neighbor's."

-- Deuteronomy 5:1,7-21 ESV

# Deep Down Detective Devotion: Unit 7, Bible Truth 1, Lesson 2



**Big Question 7:** What Are God's Laws Like?

**Answer:** God's Laws Are Perfect... They Are Written in the Bible, God's Word!

**How do I know this is true? The Bible tells me so!**

"Hear, O Israel, the statutes and the rules that I speak in your hearing today, and you shall learn them and be careful to do them... You shall have no other gods before me. You shall not make for yourself a carved image. You shall not bow down to them or serve them... You shall not take the name of the LORD your God in vain... Observe the Sabbath day, to keep it holy... Honor your father and your mother... You shall not murder. And you shall not commit adultery. And you shall not steal. And you shall not bear false witness... And you shall not covet... anything that is your neighbor's."

--- Deuteronomy 5:1,7-21, ESV

**Learn a Little:** "Hear the rules... learn them and be careful to do them."

**Meaning**

Long ago, the LORD gave the 10 Commandments and many other good laws to the people of Israel. The Israelites promised to keep them. He would be their God; they would be His people. He would bless them and take care of them. These verses are the Ten Commandments (laws) that God gave them. But even though God gave these laws to the people of Israel that day, they are laws for all of us to keep. They tell us how God wants us all to live

**Some Questions for You**

1. What is the name of the ten, big rules the LORD gave to the people of Israel? *The 10 Commandments.*
2. Can you name any of the 10 Commandments? *(name them)*
3. Who does God want to keep these laws? *Everyone.*
4. How can we know how the LORD wants us to live? *His 10 Commandments tell us.*
5. Has anyone ever kept all of God's laws? *No one, except Jesus.*
6. Who can help us keep God's good rules? *The Holy Spirit can, when we turn away from our sins and trust in Jesus as our Savior.*

**Let's Pray!**

- A** We praise You, God, for being the Giver of Your perfectly good laws.
- C** God, we confess that we break Your good laws. Sometimes, we do not obey our parents. Sometimes, we lie. Sometimes, we want things that belong to others. You made us to be law keepers, but we are all lawbreakers. We need a Savior!
- T** Thank You for giving us Your good laws, so we know how to love and obey You. Thank You for making sure they were written down just right in Your Word, the Bible. Thank You for sending Jesus to keep Your laws perfectly and make the way for people like us to be forgiven.
- S** God, work in our hearts. Help us to turn away from our sins and trust in Jesus as our Savior. Help us to learn Your good laws and obey them. Help us to love You by living for You and keeping Your good laws. In Jesus' name we pray, Amen.

**Let's Sing Our Bible Verse!**

**Hear, O Israel: Deuteronomy 5:1,6-21**

*from Deep Down Detectives ESV Songs 7, tracks 19, 20*

**Refrain:**

Hear, O Israel, the statutes and rules I speak,  
Learn them and be careful to do them,  
Be careful to do them.

**Verse 1**

You shall have no gods before Me,  
You shall not make a carved image,  
You shall not bow down or serve them.  
You shall not take the name of the Lord in vain,  
Observe the Sabbath day,  
Honor your father and mother. *Refrain*

**Verse 2**

You shall not murder,  
You shall not commit adult'ry,  
You shall not steal,  
You shall not bear false witness  
Against your neighbor,  
You shall not covet anything. *Refrain*  
Deuteronomy Five, verses one, six through twenty-one.

DDD BQ 7 BT 1 L2 Coloring Sheet/Take Home pg2

Go to the Deep Down Detectives Parent Resources for Unit 7 to get the Bible story and many more resources and songs for this unit at [praisefactory.org](http://praisefactory.org)



Which four of these clues belong in our story? Which two do not? Put an X in the boxes of the four that belong.

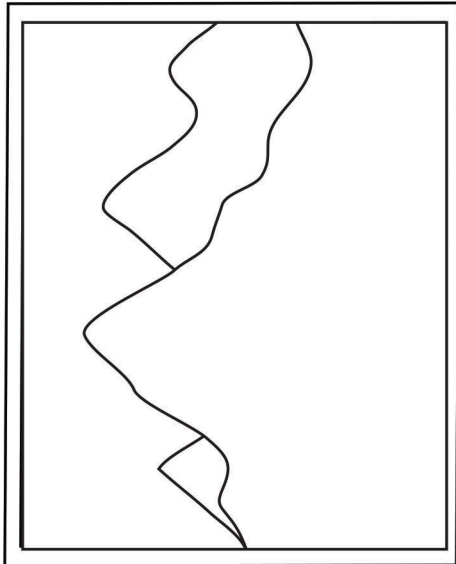

A Mountain Called Sinai

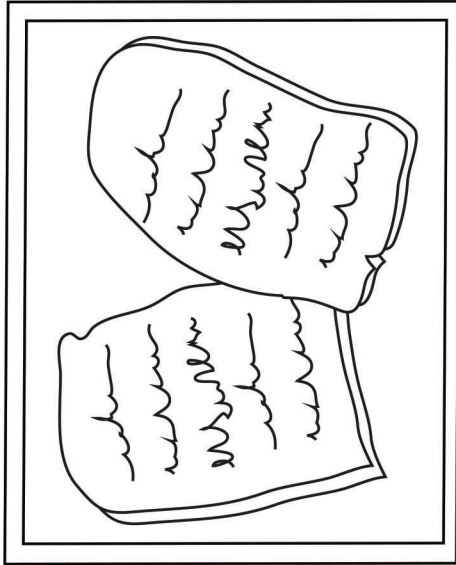

Laws Written on Stone

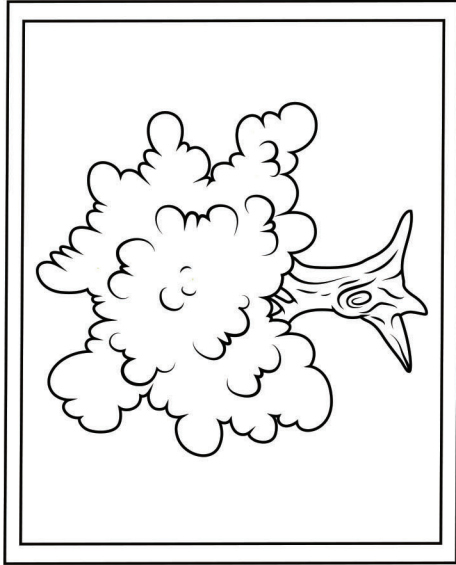

A Tree

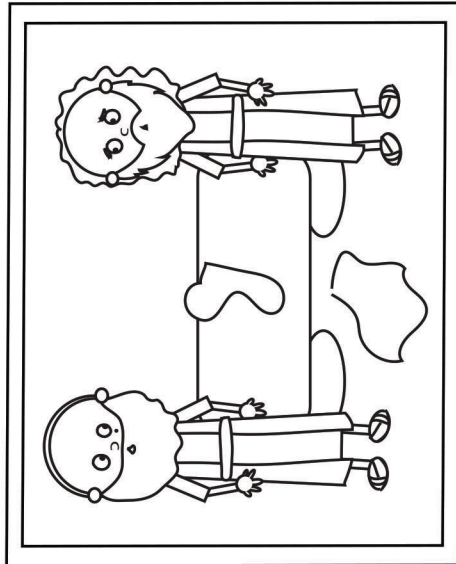

Clean Clothes

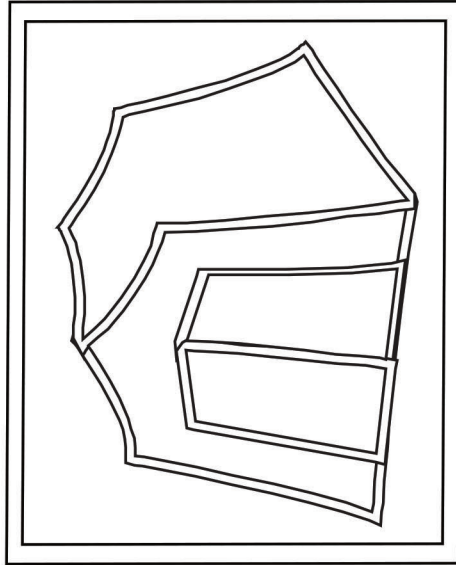

A Tent

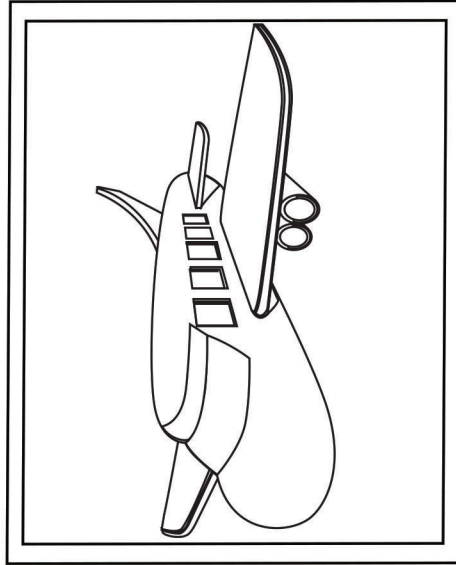

An Airplane

Answer: The mountain, the laws, the clean clothes and the tent belong. The airplane and the tree do not.

# Deep Down Detective Devotion: Unit 7, Bible Truth 1, Lesson 3



**Big Question 7:** What Are God's Laws Like?

**Answer:** God's Laws Are Perfect... They Are Written in the Bible, God's Word!

## Bible Truth 1 Meaning

A law is big rule that we are supposed to obey. God told His laws to godly people long ago. These people wrote them down in the Bible, God's Word, so everyone can know them. God's Holy Spirit helped them write them down just right. God's laws are the most important laws of all. They are rules that God wants everyone to keep. That's why God's people take time to learn God's laws and ask Him to help them obey them. They love God and want to please Him. They want to show the world what God is like by living the way He wants us to live.

## How do I know this is true? The Bible tells me so!

"Hear, O Israel, the statutes and the rules that I speak in your hearing today, and you shall learn them and be careful to do them... You shall have no other gods before me. You shall not make for yourself a carved image. You shall not bow down to them or serve them... You shall not take the name of the LORD your God in vain... Observe the Sabbath day, to keep it holy... Honor your father and your mother... You shall not murder. And you shall not commit adultery. And you shall not steal. And you shall not bear false witness... And you shall not covet... anything that is your neighbor's."

--- Deuteronomy 5:1,7-21, ESV

## Some Questions for You

1. In what book can we read God's laws? *The Bible.*
2. How did the LORD tell the people to get ready to meet with Him? What were they supposed to do to the mountain? *Set a fence around it so no animal or person would go on it when the LORD came down to meet them. Wash themselves and their clothes. Prepare their hearts.*
3. What did the people see and hear when the LORD came down the mountain? *They heard a loud trumpet and thunder. They saw lots of smoke, fire and lightning.*
4. What did the LORD tell the people when He spoke to them? *He told them His 10 Big Rules.*
5. Who do God's rules teach us to love? *God and each other.*
6. Why did the people not want the LORD to speak to them? *They were scared.*
7. Who did the people send to hear all of the LORD's laws and write them down? *Moses.*
8. Who should obey the laws of God? *Everyone --even you and me!*
9. Who can help us keep God's good rules? *The Holy Spirit can, when we turn away from our sins and trust in Jesus as our Savior.*

## Let's Pray!

- A** We praise You, God, for being the Giver of Your perfectly good laws.
- C** God, we confess that we break Your good laws. Sometimes, we do not obey our parents. Sometimes, we lie. Sometimes, we want things that belong to others. You made us to be law keepers, but we are all lawbreakers. We need a Savior!
- T** Thank You for giving us Your good laws, so we know how to love and obey You. Thank You for making sure they were written down just right in Your Word, the Bible. Thank You for sending Jesus to keep Your laws perfectly and make the way for people like us to be forgiven.
- S** God, work in our hearts. Help us to turn away from our sins and trust in Jesus as our Savior. Help us to learn Your good laws and obey them. Help us to love You by living for You and keeping Your good laws. In Jesus' name we pray, Amen.

## Let's Praise God Right Now!

**Big Question 7 Hymn: Holy Bible, Book Divine** from *Deep Down Detectives ESV Songs 7, track 17*

### Verse 1

Holy Bible, book divine,  
Precious treasure, you are mine,  
You're the only Book divine,  
Precious treasure, you are mine.

### Verse 2

Mine, to learn God's holy ways,  
How He'd have us live each day;  
Mine, to learn of Jesus Christ,  
Who died to give eternal life.

Words: John Burton, Sr., Constance Dever Music: Constance Dever

**Big Question 7 Praise Song: The Best Book to Read Is the Bible** from *Deep Down Detectives ESV Songs 7, track 18*

### Verse 1

The best book to read is the Bible,  
The best book to read is the Bible,  
It alone is God's true Word,  
With the best news ever heard!  
Yes! The best book to read is the Bible.

### Verse 2

The best book to read is the Bible,  
The best book to read is the Bible,  
If you read it ev'ry day,  
God will teach you His ways.  
Yes! The best book to read is the Bible.

DDD BQ 7 BT 1 L3 Coloring Sheet/Take Home pg2

**CAN YOU GUESS BIBLE TRUTH 2:**  
**What Are God's Laws Like?**  
**God's Laws Are Perfect...**

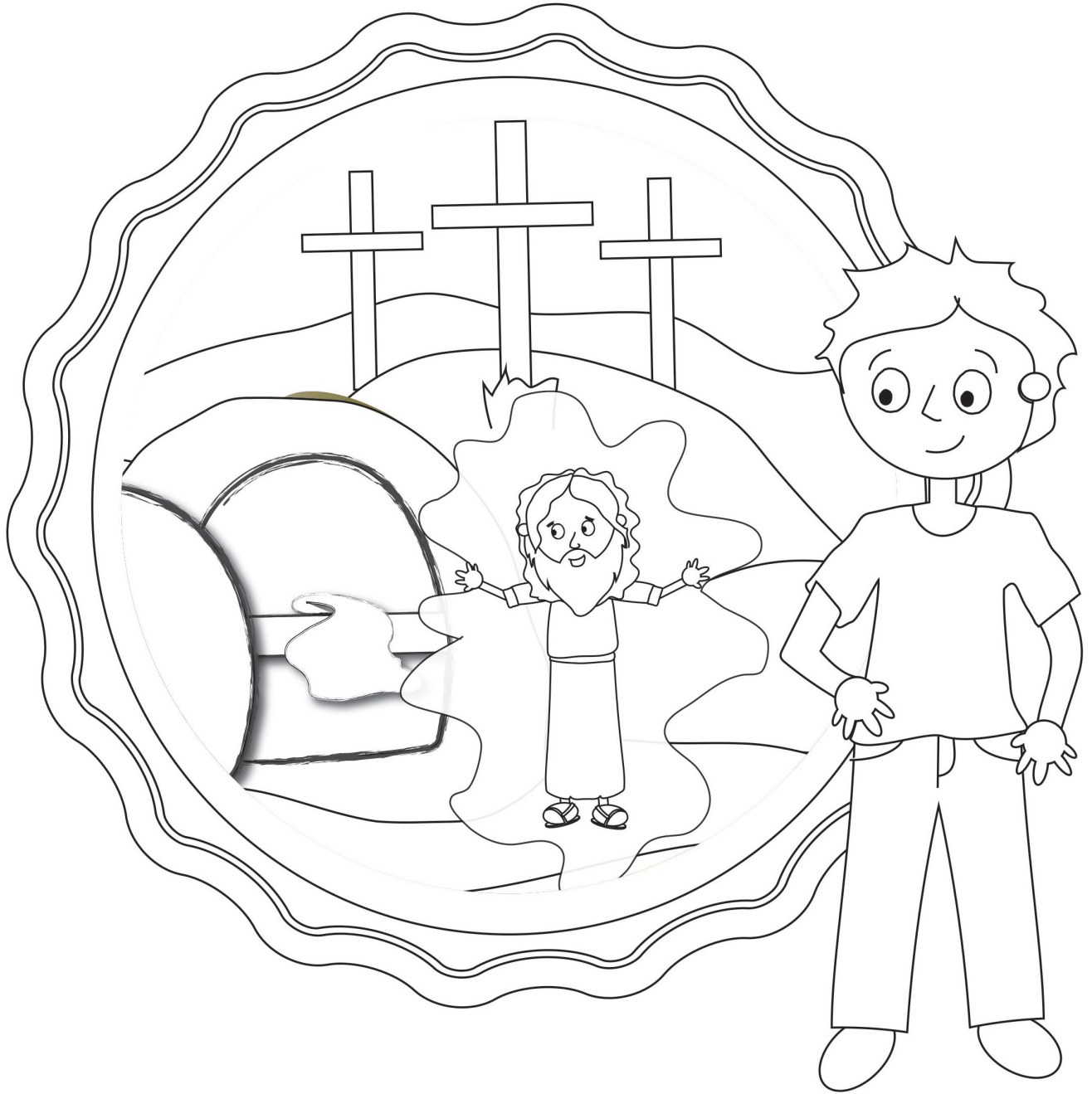

**They Show Us that We Need God to \_\_\_\_\_ Us!**

**HINT: "What did Jesus do for God's people when He died on the cross?"**

**It starts with an "s" and it rhymes with "brave."**

# Deep Down Detective Devotion: Unit 7, Bible Truth 2, Lesson 1



**Big Question 7:** What Are God's Laws Like?

**Answer:** God's Laws Are Perfect... They Show Us that We Need God to Save Us!

## Bible Truth 2 Meaning

God made us and He is in charge of us. He expects us to obey His laws all the time. But sadly, we do not. We all are sinners with sinful, selfish hearts. We disobey God's laws. We deserve His punishment for our sins. How we have rebelled against Him and His good ways! But God is so kind and merciful! He treats us better than we deserve. He sent Jesus to take the punishment for the sins of all who trust in Him as their Savior. God forgives their sins and gives them special closeness with Him in their hearts. And when they die, they will go to live with Him forever in a perfect world where there will never again be any sin. Yes! They will never again sin against Him or break His good laws. They will always love Him and others as He wants them to. How wonderful that will be! Jesus can be our Savior, too, when we turn away from our sins and trust in Him as our Savior.

## How do I know this is true? The Bible tells me so:

"For no one will be justified in [God's] sight by the works of the law...But now, apart from the law, God's righteousness has been revealed... God's righteousness through faith in Jesus Christ, to all who believe...For all have sinned and fall short of the glory of God."--Romans 3:20,21,22,23 HCSB

## Some Questions for You

1. Who made us and is in charge of us? *God.*
2. When does God expect us to obey His laws? *All the time!*
3. We don't obey God's laws all the time. Why not? *Because we are sinners with sinful, selfish hearts.*
4. What do we all deserve for disobeying God's laws? *His punishment.*
5. Who did God send to save us from our sins? *God sent Jesus to die on the cross and take the punishment that we deserve from God for our sins.*
6. What must we do for God to forgive us and save us? *Turn away from our sins and trust in Jesus as our Savior. This is how we become God's dearly-loved people.*
7. What does God give us to enjoy when we become His people? *Special closeness with Him now; and when they die, perfectly wonderful life with Him forever!*

## Let's Pray!

- A** We praise You, God, for being the Giver of Your perfectly good laws.
- C** God, instead of obeying Your good laws, we have all chosen to break them. Sometimes, we don't obey our parents. Sometimes, we lie. Sometimes, we want things that belong to others. We do not always love you most of all. These are only some of the ways we break Your good laws. Oh, how we need a Savior!
- T** Thank You, God, for giving us Your good laws, so we know how to love and obey You. And thank You for sending Jesus to perfectly live out Your laws and to give His life as the perfect payment for the sins of Your people. Thank You that He can be our Savior when we turn away from our sins and trust in Him.
- S** God, work in our hearts. Help us to turn away from disobeying You and trust in Jesus as our own Savior. Help us to know You and love You with the spirit You put inside us. Help us to learn Your good laws and obey them.  
In Jesus' name we pray, Amen.

## Let's Sing about What We're Learning!

**Big Q & A 7 Song** from *Deep Down Detectives ESV Songs 7, track 12*

(adapted version of "The Farmer in the Dell")

What are God's laws like?  
What are God's laws like?  
What are God's laws like?  
God's laws are perfect!

**Big Question 7 Action Rhyme Song** from *Deep Down Detectives ESV Songs 7, track 13*

### Refrain:

What are God's laws like?  
What are they like?  
God's laws are perfect!  
God's laws are perfect!  
What are God's laws like?  
What are they like?  
God's laws are like Him,  
They are good and just.

### Verse 1

God is our Creator,  
He's in charge of the whole world.  
He gave us laws to live by,  
They are written in His Word.  
*Refrain*

### Verse 2

God's laws are the best way,  
For us all to live,  
God calls us to obey them,  
To reflect His righteousness. *Refrain*

Go to the *Deep Down Detectives Parent Resources for Unit 7* to get the Bible story and many more resources and songs for this unit at [praisefactory.org](http://praisefactory.org)



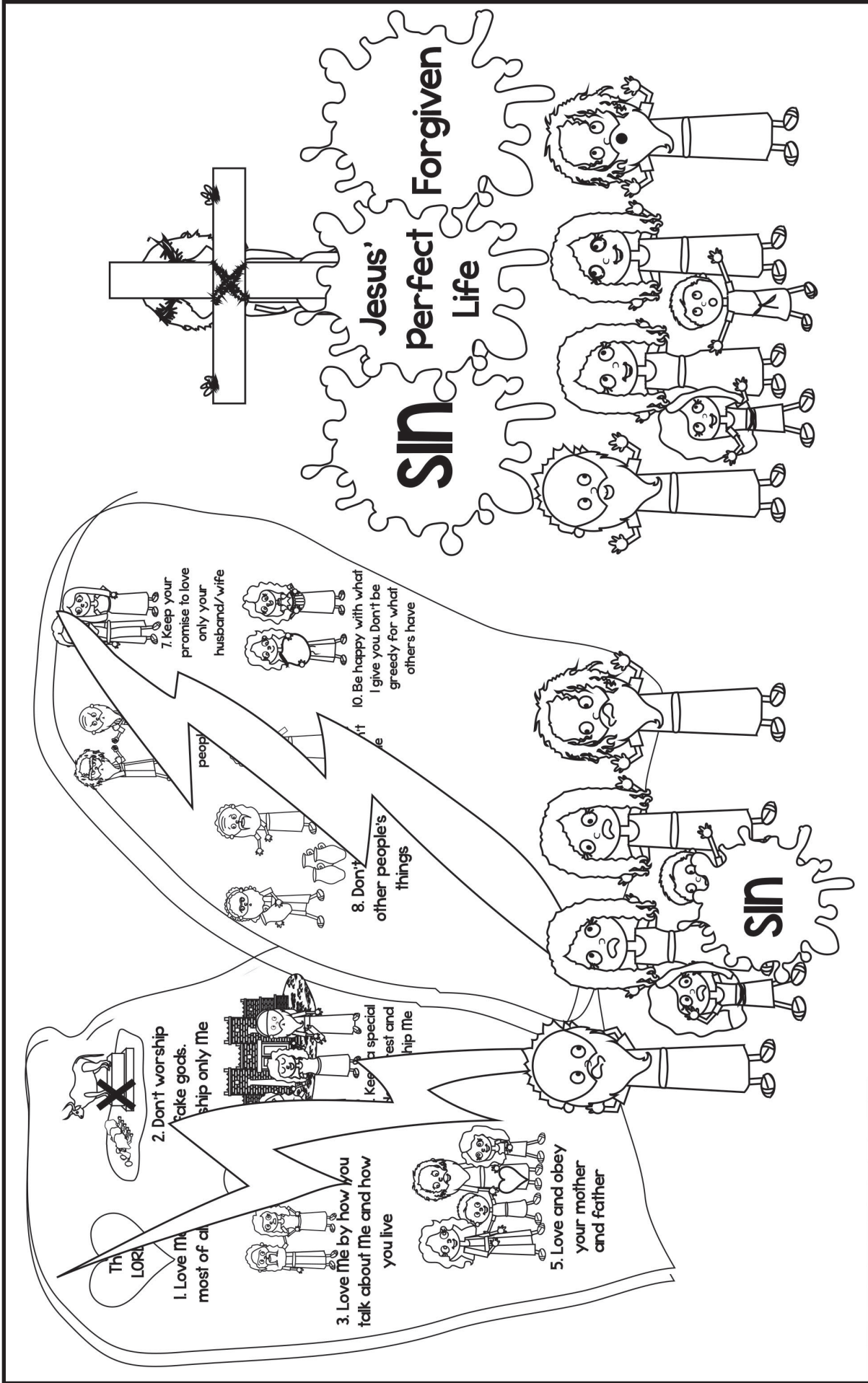

“For no one will be justified in [God’s] sight by the works of the law...But now, apart from the law, God’s righteousness has been revealed...God’s righteousness through faith in Jesus Christ, to all who believe... For all have sinned and fall short of the glory of God.” --Romans 3:20-23. HCSB



## Deep Down Detective Devotion: Unit 7, Bible Truth 2, Lesson 2



**Big Question 7:** What Are God's Laws Like?

**Answer:** God's Laws Are Perfect... They Show Us that We Need God to Save Us!

**How do I know this is true? The Bible tells me so:**

"For no one will be justified in [God's] sight by the works of the law...But now, apart from the law, God's righteousness has been revealed... God's righteousness through faith in Jesus Christ, to all who believe...For all have sinned and fall short of the glory of God."--Romans 3:20,21,22,23 HCSB

**Learn a Little:** "Apart from the law, God's righteousness has been revealed... righteousness through faith in Jesus Christ, to all who believe."

**Meaning:**

"Righteous" is a big word that means that you are right with God. The only way we can be right with God ON OUR OWN is by obeying God's laws perfectly. But, uh oh! This Bible verse tells us that we are all sinners who break God's laws. That means we can't EVER be right with God by obeying God's laws.

But God has made a way for us to be right with Him—through His Son, Jesus. Jesus came and lived a perfect life. He kept all of God's good laws perfectly. He was righteous! And this Bible verse tells us that for all who trust in Jesus as their Savior, Jesus takes away their sins and gives His righteousness to them. That means God treats them as if they had never broken God's laws or sinned-- just like Jesus! Wow! Isn't that amazing! Isn't Jesus a wonderful Savior! He can be our wonderful Savior, too, when we turn away from our sins and trust in Him as our Savior.

**Some Questions for You**

1. What does righteous mean? *God thinks everything you do is just right, as God's laws tell us to.*
2. Do any of us keep God's laws perfectly? *Are any of us righteous on our own? None of us keep God's laws perfectly. None of us are righteous by our own works (by how we obey God's laws).*
3. How did Jesus live when He came to earth? *He always kept God's laws. He was truly righteous.*
4. What did Jesus choose to give to all who trust in Him as His Savior? *His own, perfect righteous.*
5. How can Jesus become our Savior? *When we turn from our sins and trust in Him as our Savior.*
6. Who does God see as righteous because of Jesus? *All of God's people--all who turn from their sins and trust in Him as their Savior.*

**Let's Pray!**

- A** We praise You, God, for being the Giver of Your perfectly good laws.
- C** God, instead of obeying Your good laws, we have all chosen to break them. Sometimes, we don't obey our parents. Sometimes, we lie. Sometimes, we want things that belong to others. We do not always love you most of all. These are only some of the ways we break Your good laws. Oh, how we need a Savior!
- T** Thank You, God, for giving us Your good laws, so we know how to love and obey You. And thank You for sending Jesus to perfectly live out Your laws and to give His life as the perfect payment for the sins of Your people. Thank You that He can be our Savior when we turn away from our sins and trust in Him.
- S** God, work in our hearts. Help us to turn away from disobeying You and trust in Jesus as our own Savior. Help us to know You and love You with the spirit You put inside us. Help us to learn Your good laws and obey them.  
In Jesus' name we pray, Amen.

**Let's Sing Our Bible Verse!**

**Apart from the Law: Romans 3:20-23**

*from Deep Down Detectives ESV Songs 7, track 21*

By works of the law,	<i>But listen to what God has done:</i>
By works of the law,	Apart from the law,
No one will be justified,	Apart from the law,
By works of the law. <i>Why?</i>	Now God's righteousness has been revealed,
For all have sinned,	Apart from the law. <i>How?</i>
Fall short of the glory of God. <i>Oh, no!</i>	Through faith in Jesus Christ,
	To all who believe. <i>Thank you, God!</i>
	Romans Three, twenty through twenty-three.

Go to the [Deep Down Detectives Parent Resources for Unit 7](http://Deep Down Detectives Parent Resources for Unit 7) to get the Bible story and many more resources and songs for this unit at [praisefactory.org](http://praisefactory.org)

DDD BQ7 BT2 L2 Coloring Sheet/Take Home pg2

Which four of these clues belong in our story? Which two do not? Put an X in the boxes of the four that belong.

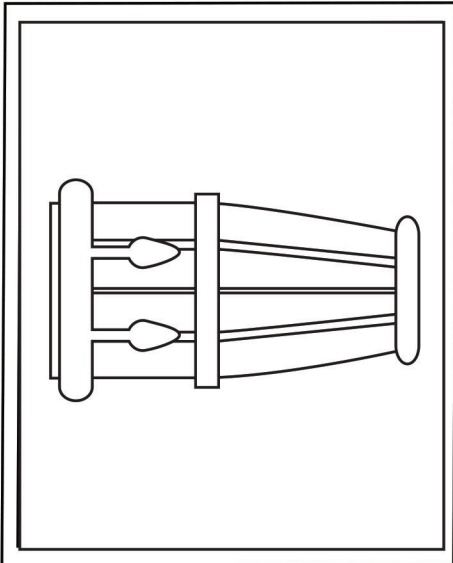

A Drum

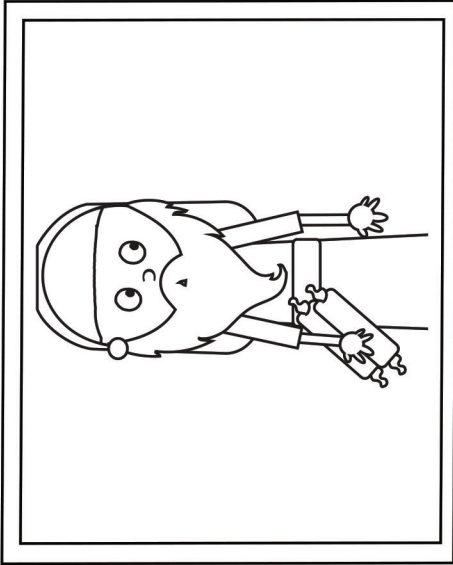

A Pharisee

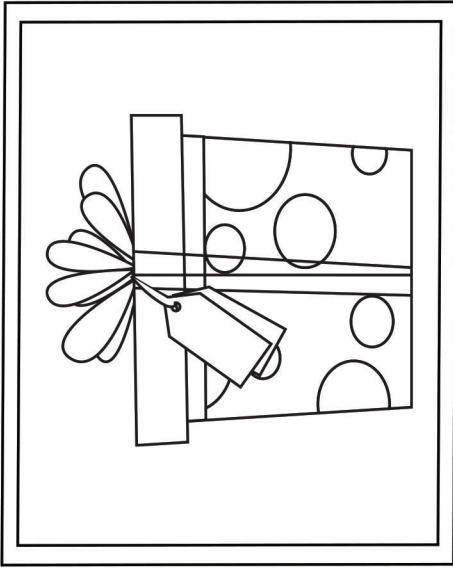

A Golden Box

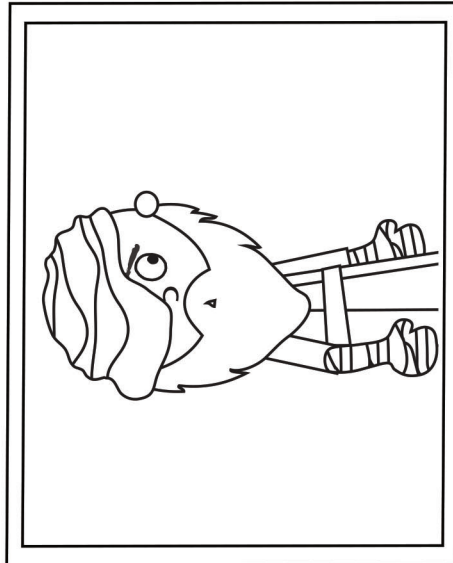

A Sick Man

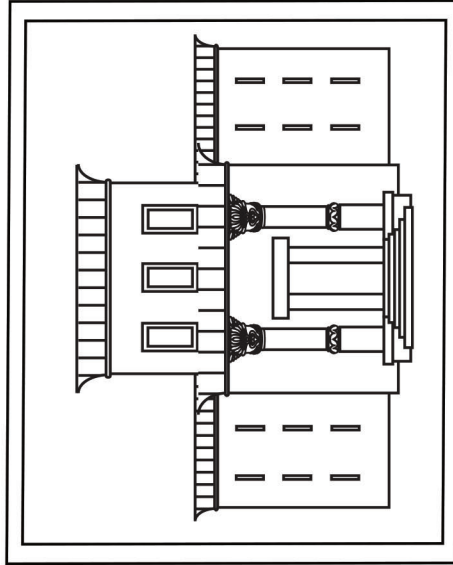

The Temple

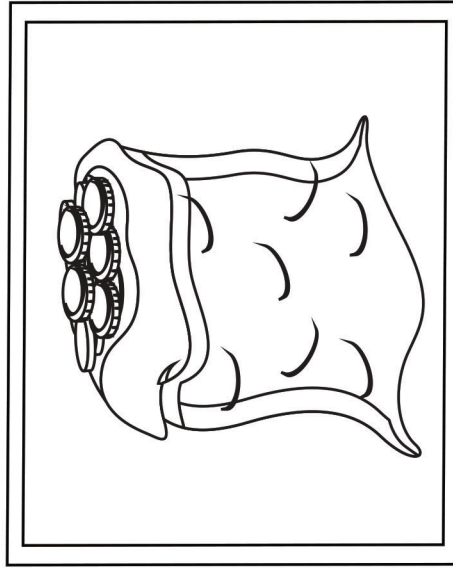

A Bag of Money

# Deep Down Detective Devotion: Unit 7, Bible Truth 2, Lesson 3



**Big Question 7:** What Are God's Laws Like?

**Answer:** God's Laws Are Perfect... They Show Us that We Need God to Save Us!

## Bible Truth 2 Meaning

God made us and He is in charge of us. He expects us to obey His laws all the time. But sadly, we do not. We all are sinners with sinful, selfish hearts. We disobey God's laws. We deserve His punishment for our sins. How we have rebelled against Him and His good ways! But God is so kind and merciful! He treats us better than we deserve. He sent Jesus to take the punishment for the sins of all who trust in Him as their Savior. God forgives their sins and gives them special closeness with Him in their hearts. And when they die, they will go to live with Him forever in a perfect world where there will never again be any sin. Yes! They will never again sin against Him or break His good laws. They will always love Him and others as He wants them to. How wonderful that will be! Jesus can be our Savior, too, when we turn away from our sins and trust in Him as our Savior.

## How do I know this is true? The Bible tells me so:

"For no one will be justified in [God's] sight by the works of the law...But now, apart from the law, God's righteousness has been revealed... God's righteousness through faith in Jesus Christ, to all who believe...For all have sinned and fall short of the glory of God."--Romans 3:20,21,22,23 HCSB

## Some Questions for You

1. What did Jesus teach the Pharisees who tried so hard to be good? Did they need God to save them? *Yes, they did! We all need God to save us, no matter how hard we try to be good.*
2. Where did all the extra rules of the Pharisees come from? From God in the Bible? *No, they did not! They were made up by other teachers. They were lots of extra rules that God didn't tell His people to obey.*
3. Why weren't the Pharisees eager to hear about Jesus like the other people? *They thought they were so good that they didn't need to be saved. They didn't like that Jesus did tell people to keep all those extra rules.*
4. Did the Pharisee or the tax collector go home with everything right with God? *The tax collector did, even though he had done many bad, bad things. The Pharisee did not.*
5. Why did God forgive the tax collector? *Because he humbly asked God to forgive him.*
6. Why did the Pharisee go home with things not right between him and God? *Because he was proud. He didn't tell God that he had disobeyed Him. He didn't ask God to forgive him. He thought he was too good to need God's forgiveness.*
7. How does God want us to be like the tax collector? *By humbly telling God about the bad things we've done and ask His forgiveness through Jesus.*

## Let's Pray!

- A** We praise You, God, for being the Giver of Your perfectly good laws.
- C** God, instead of obeying Your good laws, we have all chosen to break them. Sometimes, we don't obey our parents. Sometimes, we lie. Sometimes, we want things that belong to others. We do not always love you most of all. These are only some of the ways we break Your good laws. Oh, how we need a Savior!
- T** Thank You, God, for giving us Your good laws, so we know how to love and obey You. And thank You for sending Jesus to perfectly live out Your laws and to give His life as the perfect payment for the sins of Your people. Thank You that He can be our Savior when we turn away from our sins and trust in Him.
- S** God, work in our hearts. Help us to turn away from disobeying You and trust in Jesus as our own Savior. Help us to know You and love You with the spirit You put inside us. Help us to learn Your good laws and obey them.  
In Jesus' name we pray, Amen.

## Let's Praise God Right Now!

DDD BQ 7 BT 1 L3 Coloring Sheet/Take Home pg2

## Big Question 7 Hymn: Holy Bible, Book Divine from Deep Down Detectives ESV Songs 7, track 17

### Verse 1

Holy Bible, book divine,  
Precious treasure, you are mine,  
You're the only Book divine,  
Precious treasure, you are mine.

### Verse 2

Mine, to learn God's holy ways,  
How He'd have us live each day;  
Mine, to learn of Jesus Christ,  
Who died to give eternal life.

## Big Question 7 Praise Song: The Best Book to Read Is the Bible from Deep Down Detectives ESV Songs 7, track 18

### Verse 1

The best book to read is the Bible,  
The best book to read is the Bible,  
It alone is God's true Word,  
With the best news ever heard!  
Yes! The best book to read is the Bible.

### Verse 2

The best book to read is the Bible,  
The best book to read is the Bible,  
If you read it ev'ry day,  
God will teach you His ways.  
Yes! The best book to read is the Bible.

Go to the Deep Down Detectives Parent Resources for Unit 7 to get the Bible story and many more resources and songs for this unit at [praisefactory.org](http://praisefactory.org)

**CAN YOU GUESS BIBLE TRUTH 3:  
What Are God's Laws Like?  
God's Laws Are Perfect...**

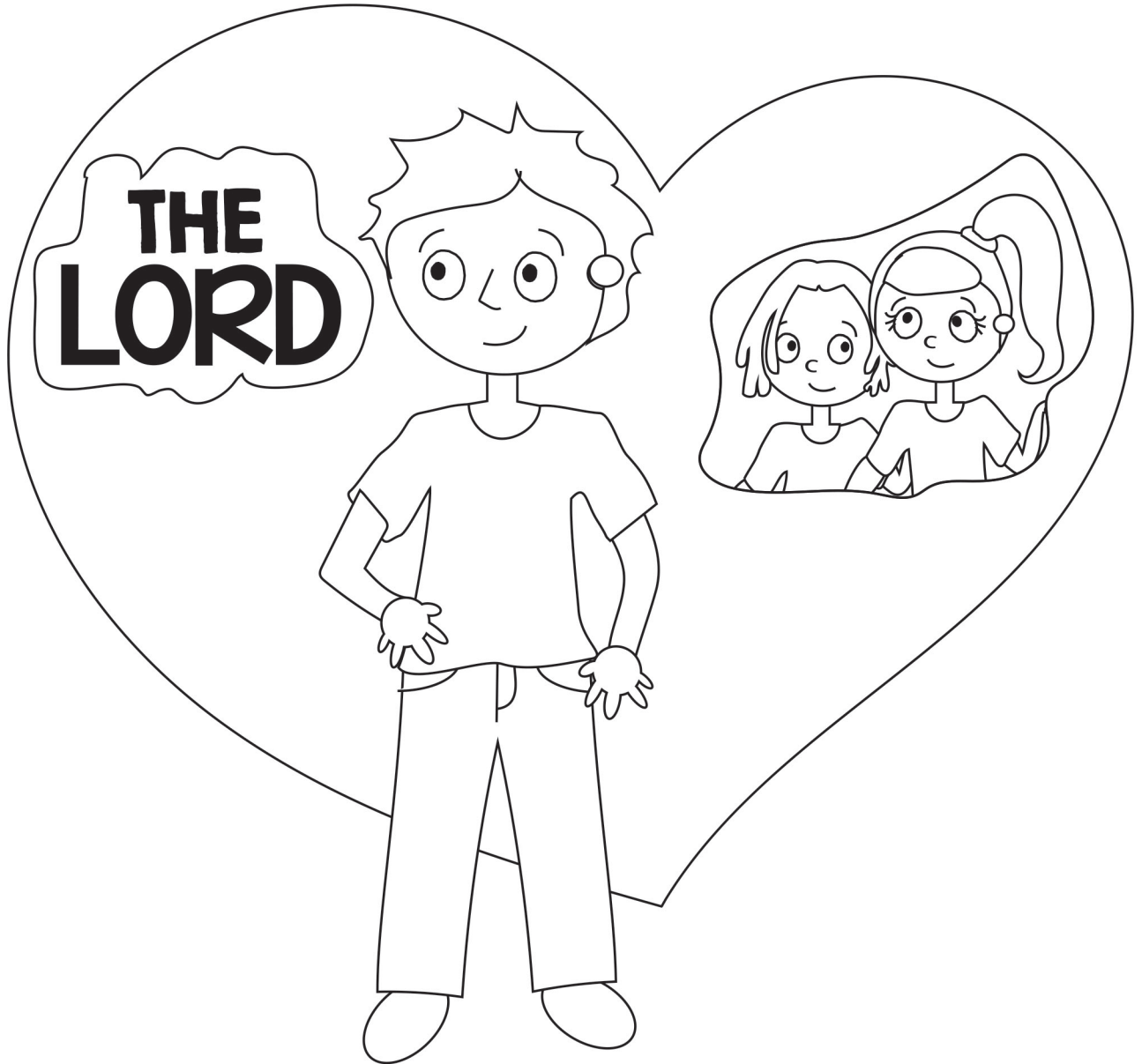

**They tell us how to ----- God and others!**

**HINT: How does God want us to want towards Himself and others?  
It starts with an "L" and it rhymes with "dove."**

# Deep Down Detective Devotion: Unit 7, Bible Truth 3, Lesson 1



**Big Question 7:** What Are God's Laws Like?

**Answer:** God's Laws Are Perfect... They Tell Us How to Love God and Others!

## Bible Truth 3 Meaning

The LORD is the one, true God. He deserves our love. He made us to love Him more than anything else. Loving God is the most delightful thing we can do. God gave us His laws so we can know how to love Him. When we obey His laws, we are living out our love for Him. God made us not just to love Him, but also to love each other. He gave His laws so we can know how to love each other. He tells us to treat others in the same loving way we want others to treat us. When we obey God's laws, we are living out God's love for others. And, we are showing them a little bit of what God is like, that they might seek to know and love Him, too. Obeying God's laws is not just the right way to live. It is also the happiest way to live with God and with other people. God can help us obey His laws and live in love when we turn away from our sins and trust in Jesus as our Savior. He gives us a new heart filled with His Holy Spirit and helps us to live in love as He wants us to.

## How do I know this is true? The Bible tells me so!

"You shall love the Lord your God with all your heart and with all your soul and with all your mind. This is the great and first commandment. And a second is like it: You shall love your neighbor as yourself. On these two commandments depend all the Law and the Prophets."—Matthew 22:37-40, ESV

## Some Questions for You

1. Who is the only true God? *The LORD.*
2. Who did the LORD make us to love more than anything or anyone else? *Himself!*
3. What is the most delightful thing we can do? *Love God.*
4. Who does God's laws show us how to love? *How to love Him and how to love others.*
5. How should we treat others? *In the same loving way we want others to treat us.*
6. What is the right way to live? *Obeying God's laws as He tells us to.*
7. What is the happiest way to live with God and other people? *Obeying God's laws.*
8. Who can help us to love God and others? *God can. He can help us turn away from our sins and trust in Jesus as our Savior. He can send the Holy Spirit to live in our hearts and help us to love Him and others as He wants us to.*

## Let's Pray!

- A** We praise You, God, for being the Giver of Your perfectly good laws.
- C** God, many times, we do not obey Your good laws. Many times, we do not love You or others as Your laws tell us to. We need a Savior!
- T** Thank You, God, for giving us Your good laws that show us how to love You and others. Thank You for sending Your Holy Spirit to live in our hearts when we trust in Jesus as our Savior. He helps us to obey Your good and loving laws.
- S** God, work in our hearts. Help us to turn away from our sins and trust in Jesus as our Savior. Send Your Holy Spirit to live inside our hearts and help us to love You and others as You want us to. In Jesus' name we pray, Amen.

## Let's Sing about What We're Learning!

**Big Q & A 7 Song** from *Deep Down Detectives ESV Songs 7, track 12*  
(adapted version of "The Farmer in the Dell")

What are God's laws like?  
What are God's laws like?  
What are God's laws like?  
God's laws are perfect!

**Big Question 7 Action Rhyme Song** from *Deep Down Detectives ESV Songs 7, track 13*

### Refrain:

What are God's laws like?  
What are they like?  
God's laws are perfect!  
God's laws are perfect!  
What are God's laws like?  
What are they like?  
God's laws are like Him,  
They are good and just.

### Verse 1

God is our Creator,  
He's in charge of the whole world.  
He gave us laws to live by,  
They are written in His Word.  
*Refrain*

### Verse 2

God's laws are the best way,  
For us all to live,  
God calls us to obey them,  
To reflect His righteousness. *Refrain*



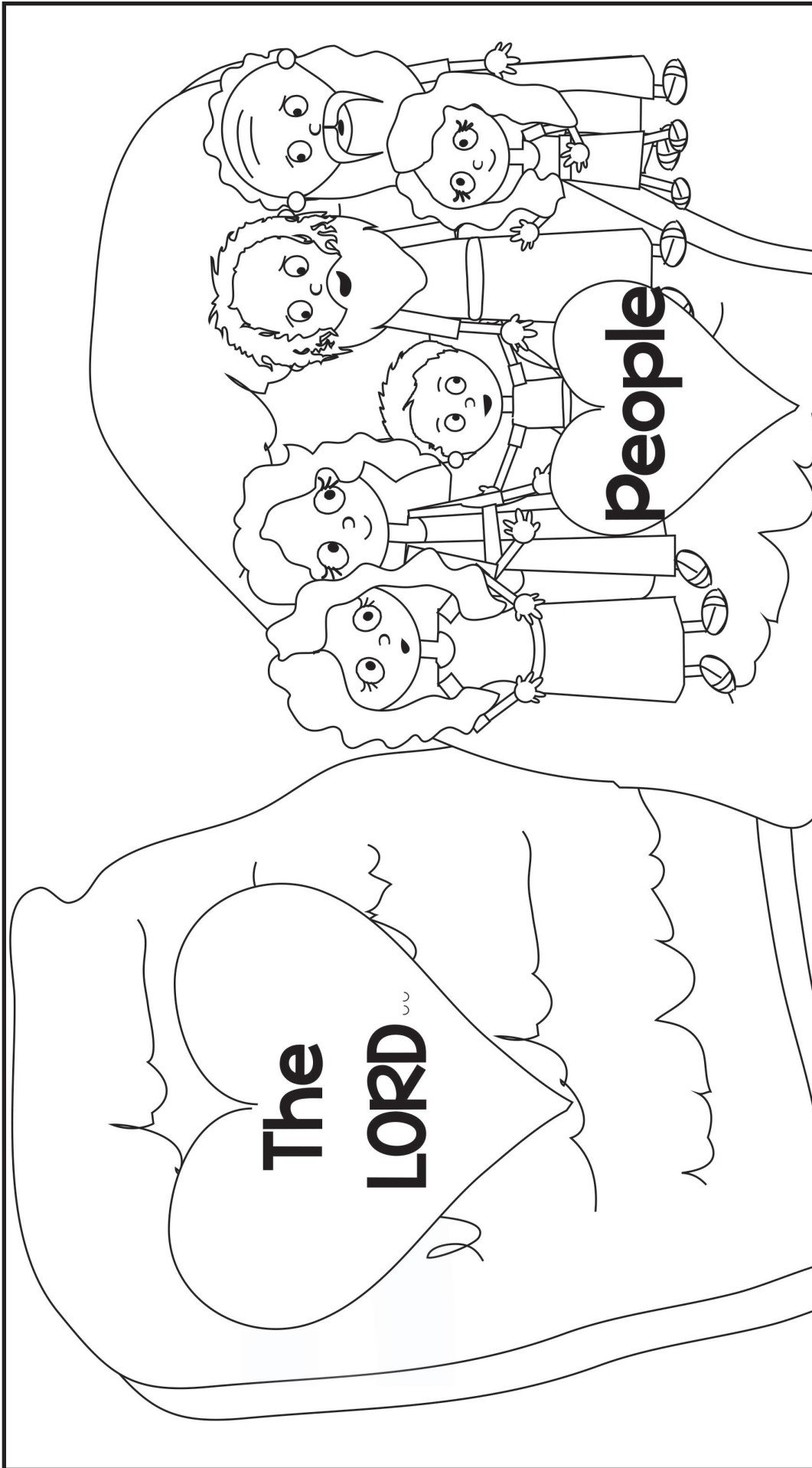

**“You shall love the Lord your God with all your heart and with all your soul and with all your mind.**

**This is the great and first commandment.**

**And a second is like it: You shall love your neighbor as yourself.**

**On these two commandments depend all the Law and the Prophets.”**

**Matthew 22:37-40, ESV**

## Deep Down Detective Devotion: Unit 7, Bible Truth 3, Lesson 2



**Big Question 7:** What Are God's Laws Like?

**Answer:** God's Laws Are Perfect... They Tell Us How to Love God and Others!

**How do I know this is true? The Bible tells me so!**

"You shall love the Lord your God with all your heart and with all your soul and with all your mind. This is the great and first commandment. And a second is like it: You shall love your neighbor as yourself. On these two commandments depend all the Law and the Prophets."--Matthew 22:37-40, ESV

**Learn a Little:** "Love the Lord your God with all your heart, soul and mind... Love your neighbor as yourself."

### Meaning

God has given us many laws in the Bible. It's good to know them all. But Jesus tells us in these verses that the purpose behind all of God's laws is to love God most of all, and to love others as we love ourselves. When we live out all His good laws, we are loving God and love others as He wants us to.

### Some Questions for You

1. What did Jesus say was the first and greatest law? *To love God most of all.*
2. What did Jesus say was the second most important law of God that we should all obey? *To love others in the same loving way as we want others to treat us.*
3. What two laws did Jesus say sum up all of the other laws that God has given us? *To love God most of all, and love others in the same loving way as we want others to treat us.*
4. Who can help us to love God and others? *God can. He can help us turn away from our sins and trust in Jesus as our Savior. He can send the Holy Spirit to live in our hearts and help us to love Him and others as He wants us to.*

### Let's Pray!

- A** We praise You, God, for being the Giver of Your perfectly good laws.
- C** God, many times, we do not obey Your good laws. Many times, we do not love You or others as Your laws tell us to. We need a Savior!
- T** Thank You, God, for giving us Your good laws that show us how to love You and others. Thank You for sending Your Holy Spirit to live in our hearts when we trust in Jesus as our Savior. He helps us to obey Your good and loving laws.
- S** God, work in our hearts. Help us to turn away from our sins and trust in Jesus as our Savior. Send Your Holy Spirit to live inside our hearts and help us to love You and others as You want us to. In Jesus' name we pray, Amen.

### Let's Sing Our Bible Verse!

**Love the Lord: Matthew 22:37-40** from *Deep Down Detectives ESV Songs 7, track 27*

Love the Lord your God with all your heart,  
Love the Lord your God with all your soul,  
Love the Lord your God with all your mind,  
This is the first and greatest commandment.

*And the second is like it...*

Love your neighbor as yourself,  
Love your neighbor as yourself,  
Love your neighbor as yourself,  
On these two commandments depend,  
All the Law and Prophets.  
Matthew Twenty-two, thirty-seven through forty.

Go to the *Deep Down Detectives Parent Resources for Unit 7* to get the Bible story and many more resources and songs for this unit at [praisefactory.org](http://praisefactory.org)

DDD BQ 7 BT3 L2 Coloring Sheet/Take Home pg2

Which four of these clues belong in our story? Which two do not? Put an X in the boxes of the four that belong.

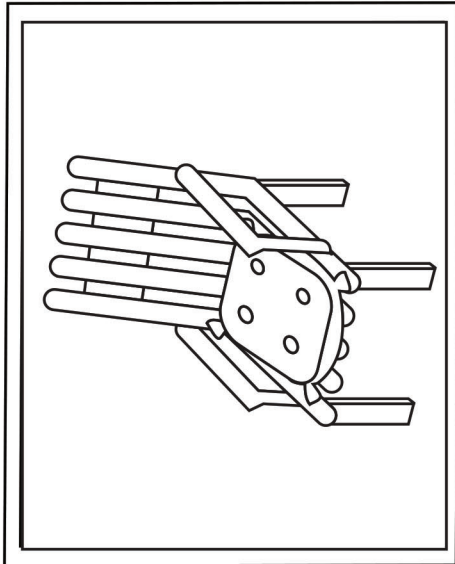

A Pillow

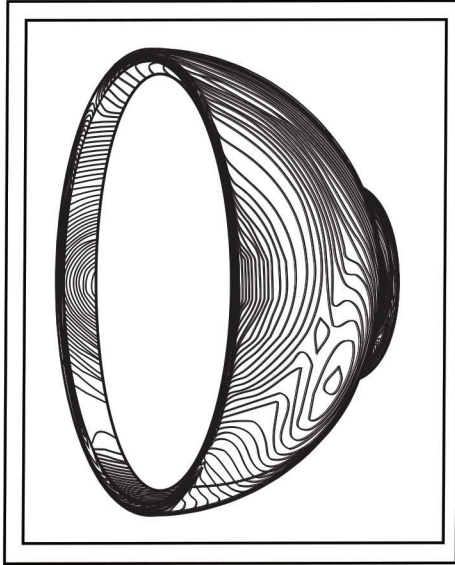

A Cup

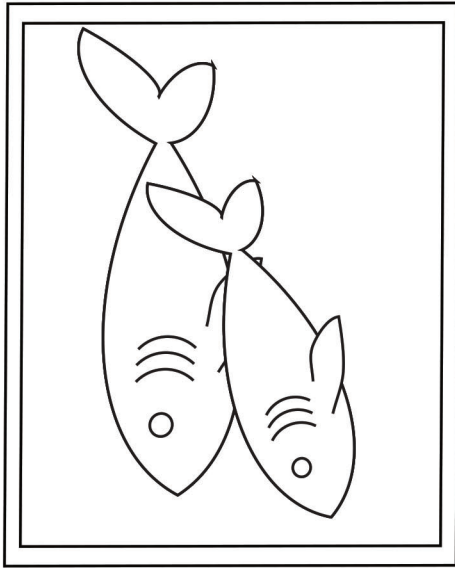

Two Fish

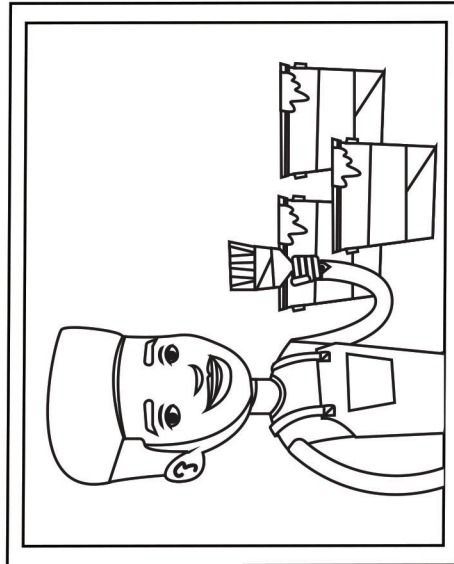

A Dead Person

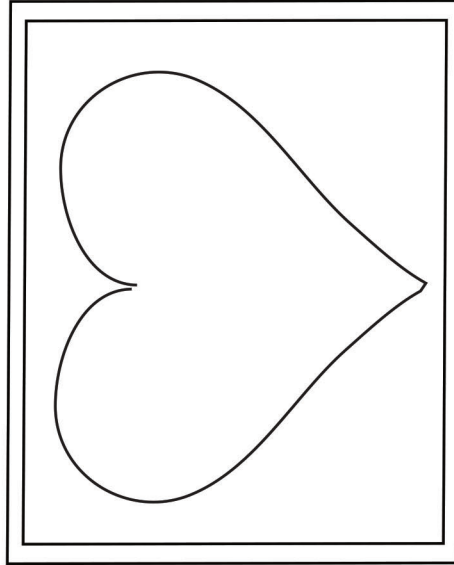

A Heart

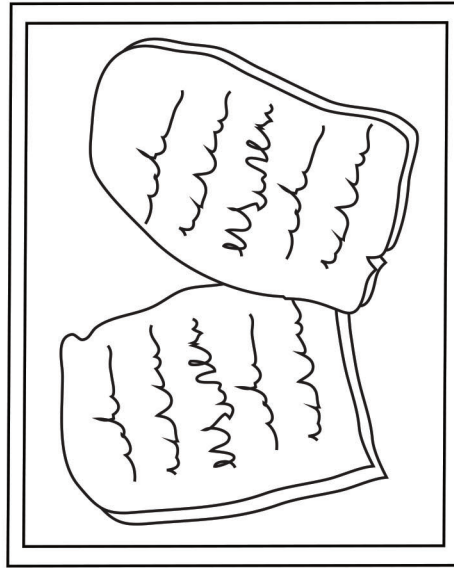

God's Ten, Big Laws

Answer: The cup, the fish, the heart and God's Ten, Big Laws. The painter and the pillow do not.

# Deep Down Detective Devotion: Unit 7, Bible Truth 3, Lesson 3



**Big Question 7:** What Are God's Laws Like?

**Answer:** God's Laws Are Perfect... They Tell Us How to Love God and Others!

## Bible Truth 3 Meaning

The LORD is the one, true God. He deserves our love. He made us to love Him more than anything else. Loving God is the most delightful thing we can do. God gave us His laws so we can know how to love Him. When we obey His laws, we are living out our love for Him. God made us not just to love Him, but also to love each other. He gave His laws so we can know how to love each other. He tells us to treat others in the same loving way we want others to treat us. When we obey God's laws, we are living out God's love for others. And, we are showing them a little bit of what God is like, that they might seek to know and love Him, too. Obeying God's laws is not just the right way to live. It is also the happiest way to live with God and with other people. God can help us obey His laws and live in love when we turn away from our sins and trust in Jesus as our Savior. He gives us a new heart filled with His Holy Spirit and helps us to live in love as He wants us to.

## How do I know this is true? The Bible tells me so!

"You shall love the Lord your God with all your heart and with all your soul and with all your mind. This is the great and first commandment. And a second is like it: You shall love your neighbor as yourself. On these two commandments depend all the Law and the Prophets."--Matthew 22:37-40, ESV

## Some Questions for You

1. What is the name of the Ten, Big Laws that God gave to show us how to love God and others? *The Ten Commandments.*
2. Did the teachers in Jesus' day tell people to keep just the 10 Commandments and other laws that God gave them in His Word, the Bible? *No. They told people to keep a lot of other rules, too.*
3. Did Jesus tell people to keep all those extra rules the other teachers gave to the people? *No, He did not. He taught them that those extra rules were not God's laws at all.*
4. What did Jesus say was the first and greatest law? *To love God most of all.*
5. What did Jesus say was the second most important law of God that we should all obey? *To love others in the same loving way as we want others to treat us.*
6. What two laws did Jesus say sum up all of the other laws that God has given us? *To love God most of all, and love others in the same loving way as we want others to treat us.*
7. Who can help us to love God and others? *God can. He can help us turn away from our sins and trust in Jesus as our Savior. He can send the Holy Spirit to live in our hearts and help us to love Him and others as He wants us to.*

## Let's Pray!

- A** We praise You, God, for being the Giver of Your perfectly good laws.
- C** God, many times, we do not obey Your good laws. Many times, we do not love You or others as Your laws tell us to. We need a Savior!
- T** Thank You, God, for giving us Your good laws that show us how to love You and others. Thank You for sending Your Holy Spirit to live in our hearts when we trust in Jesus as our Savior. He helps us to obey Your good and loving laws.
- S** God, work in our hearts. Help us to turn away from our sins and trust in Jesus as our Savior. Send Your Holy Spirit to live inside our hearts and help us to love You and others as You want us to. In Jesus' name we pray, Amen.

## Let's Praise God Right Now!

**Big Question 7 Hymn: Holy Bible, Book Divine** from *Deep Down Detectives* ESV Songs 7, track 17

### Verse 1

Holy Bible, book divine,  
Precious treasure, you are mine,  
You're the only Book divine,  
Precious treasure, you are mine.

### Verse 2

Mine, to learn God's holy ways,  
How He'd have us live each day;  
Mine, to learn of Jesus Christ,  
Who died to give eternal life.

Words: John Burton, Sr., Constance Dever Music: Constance Dever

**Big Question 7 Praise Song: The Best Book to Read Is the Bible** from *Deep Down Detectives* ESV Songs 7, track 18

### Verse 1

The best book to read is the Bible,  
The best book to read is the Bible,  
It alone is God's true Word,  
With the best news ever heard!  
Yes! The best book to read is the Bible.

### Verse 2

The best book to read is the Bible,  
The best book to read is the Bible,  
If you read it ev'ry day,  
God will teach you His ways.  
Yes! The best book to read is the Bible.

Go to the *Deep Down Detectives* Parent Resources for Unit 7 to get the Bible story and many more resources and songs for this unit at [praisefactory.org](http://praisefactory.org)