

DEEP DOWN DETECTIVES



Unit 3

Simple Story Scenes, ESV

The Good News of God, the Gospel



Curriculum for preschool and elementary age children,
training tools, music and other resources
are available for download or to order at:
www.praisefactory.org

© 2022 Praise Factory Media all rights reserved. May be reproduced by licensed user for classroom purposes only.

This and many other resources are available online at www.praisefactory.org

Scripture quotations marked (NIV) are taken from the Holy Bible, New International Version®, NIV®, Copyright © 1973, 1978, 1984 by Biblica, Inc.™ Used by permission of Zondervan. All rights reserved worldwide.www.zondervan.com

Scripture quotations marked (ESV) are from The Holy Bible, English Standard Version® (ESV®), copyright © 2001 by Crossway, a publishing ministry of Good News Publishers. Used by permission. All rights reserved.

Scripture quotations marked HCSB are taken from the Holman Christian Standard Bible®, Copyright © 1999, 2000, 2002, 2003, 2009 by Holman Bible Publishers. Used by permission. Holman Christian Standard Bible®, Holman CSB®, and HCSB® are federally registered trademarks of Holman Bible Publishers.

Table of Contents

About Deep Down Detective Resources	4
Unit 3: The Good News of God, the Gospel	
What Is the Gospel?	
It's Salvation through Faith in Jesus Christ!	
Unit Overview	5
Bible Truth 1: God Made Us and We Should Obey Him	7
Bible Truth 1 Overview	9
Story Scenes	11
Bible Truth 2: We Have All Disobeyed God and Deserve His Punishment	47
Bible Truth 2 Overview	49
Story Scenes	51
Bible Truth 3: God Sent Jesus to Pay for the Sins of God's People	109
Bible Truth 3 Overview	111
Story Scenes	113
Bible Truth 4: God Saves All Who Repent of Their Sins and Trust in Jesus as Their Savior	161
Bible Truth 4 Overview	163
Story Scenes	165
Take-Home Sheets	211
Bible Truth 1	213
Bible Truth 2	219
Bible Truth 3	225
Bible Truth 4	231

Deep Down Detectives Curriculum Resources

There are five companion resources for each of the sixteen units of Deep Down Detectives. Use whichever resources are useful to your setting. Deep Down Detectives resources are available as free, digital downloads at praisefactory.org, or for purchase as hard copies through amazon.com.

Make sure to check out the “Bits and Pieces” section of the Deep Down Detectives curriculum online. It has all of the resources separated out making it easy for you simply to pick, choose and print out whatever you want.

Deep Down Detectives Core Curriculum Book, ESV/NIV for each unit

The Deep Down Detectives Core Curriculum book contains the curriculum introduction, the lesson plans, stories, music, activities and take home sheets for each of the units.

Deep Down Detectives Visual Aids with Simple Story Scenes, ESV/NIV for each unit

This resource provides large, colorful signs of the key concepts used in the unit, PLUS, easy-to-use, colorful scenes that you hold up in sequence as you tell the story. The story text for each scene is printed on the bottom of each scene.

Deep Down Detectives Simple Story Scenes, ESV/NIV for each volume

This resource includes only 2-page overview for Bible Truth, the story scenes, and take home sheets. This is a great, basic resource for use at home and in many classroom teaching situations.

Deep Down Detectives Small Format Visual Aids, ESV/NIV (Small Format Storyboard Pictures) for each volume

This resource provides large, colorful signs of the key concepts used in the unit, PLUS, colorful storyboard (flannelgraph) pictures to cut out and use as you tell each story. These storyboard pictures are for use with storyboards at least 24" x 36" in size.

Deep Down Detectives Large Format Visual Aids, ESV/NIV (Large Format Storyboard Pictures) for each volume

This resource provides large, colorful signs of the key concepts used in the unit. It also provides colorful storyboard (flannelgraph) pictures to cut out and use as you tell each story. These storyboard pictures are for use with storyboards 36" x 48" in size.

All of these materials may be photocopied for non-commercial church, classroom or school use by licensed users.

Other Resources in the Praise Factory Family of Curriculum

Deep Down Detectives is the second in a family of three, inter-related curriculums:

- Hide 'n' Seek Kids (focus group: ages 2-4; adaptable range: ages 2-pre-K 5's)
- Deep Down Detectives (focus group: ages 4--6's; adaptable range: ages 3-2nd grade)
- PFI: (focus group: grades K-5th grade; adaptable range: pre-K 5's-6th grade)

Each curriculum teaches the same biblical themes, but are presented in greater depth as the children grow and develop. Together, the curriculums work like an expanding spiral of truth that returns to reinforce the same truths with each curriculum, yet leading the children to deeper understanding with each step up.

Learn more about these curriculums as well as other resources and ideas for reaching children with the gospel at: www.praisefactory.org.

Unit 3: The Good News of God, the Gospel

UNIT OVERVIEW

Gospel means “good news.” In the Bible, the gospel is the good news that God sent His Son Jesus to save sinners like you and me from the punishment we deserve for our sins. That salvation is ours when we turn from our sins and trust in Jesus as our own Savior. Now that is good news indeed!

In this unit we will learn four ways the gospel is such good news.

UNIT BIBLE VERSE: John 3:16

“For God so loved the world that he gave his one and only Son, that whoever believes in him shall not perish but have eternal life.”

BIG QUESTION UNDER INVESTIGATION: What Is the Gospel?

ANSWER: It’s Salvation through Faith in Jesus Christ!

OPTIONAL Big Question 3 INTRODUCTION LESSON (Use Hide ‘n’ Seek Kids Unit 3 Material)

Story: The Case of the Stranger’s Very Good News *Acts 8:1-8*

Bible Verse: John 3:16

BIBLE TRUTH 1: God Made Us and We Should Obey Him (3 Lessons Available)

Story: The Case of the God Who Was Different *Acts 17:16-33*

Bible Verse: Psalm 100:1-6

BIBLE TRUTH 2: We Have All Disobeyed God and Deserve His Punishment (3 Lessons Available)

Story: The Case of the Squabbling Brothers and Sisters *Romans*

Bible Verse: Ecclesiastes 7:20,29

BIBLE TRUTH 3: God Sent Jesus to Pay for the Sins of God’s People (3 Lessons Available)

Story: The Case of the Savior, from Start to Finish *Genesis, The Gospels*

Bible Verse: Psalm 119:18,72-73

BIBLE TRUTH 4: God Saves All Who Repent of Their Sins and Trust in Jesus as Their Savior

(3 Lessons Available)

Story: The Case of Cruddy Crete *Titus*

Bible Verse: Mark 1:15

Deep Down Detectives ESV Songs 3 Track Numbers

This is a listing of all songs mentioned in the unit curriculum. You may or may not choose to use all of the songs. They are listed in easy-reference order--NOT in the order used in the curriculum.

You may choose to simply burn a CD/load them onto an mp3 device in this order. Or, you may want to do what we do: choose the songs we want to use and create a play list of them in that order. Then, we burn a CD/upload the play list onto an mp3 device. A teacher only has to click forward to the next song, instead of hunting for the right track. The track number have been included as part of the title of each song, so teachers will still have a reference to the track number listed in the curriculum (same as those listed below), even if you change the order on your customized play list.

SONGS USED EVERY UNIT OF THE CURRICULUM

- 1 The Classroom Song v.1
- 2 The Classroom Song v.2
- 3 The Classroom Song v.3
- 4 The Classroom Song v.4
- 5 Deep Down Detectives Theme Song
- 6 The Classroom Rules Song
- 7 Let's Pray Song
- 8 The Big Question Box Song
- 9 The Bible Chant Song
- 10 ACTS Prayer Song (Short Version)
- 11 ACTS Prayer Song (Full Version)

Why the Extra Songs?

Deep Down Detectives is a curriculum used by a wide age-span of kids. Sometimes one of the other songs is a better fit for your kids. Or, you may simply want to teach them more songs on the same Bible Truth. Use as many or as few as you want.

UNIT 3: GOD'S GOOD NEWS, THE GOSPEL

- 12 Big Q & A 3 Song
- 13 Big Question 3 Song: What's the Gospel?
- 14 Big Question 3 Bible Verse Song: For God So Loved the World John 3:16 ESV
- 15 *Extra Big Question 3 Bible Verse Song: For God So Loved the World John 3:16 ESV (version 2)*
- 16 *Extra Big Question 3 Bible Verse Song: For God So Loved the World John 3:16 ESV (version 3)*
- 17 Big Question 3 Hymn: And Can It Be, v.1 Refrain
- 18 Big Question 3 Praise Song: I Have Decided to Follow Jesus

What Is the Gospel?

Salvation through Faith in Christ...

Bible Truth 1: God Made Us and We Should Obey Him

- 19 Bible Verse: Make a Joyful Noise Psalm 100:1-6 ESV
- 20 *Extra Bible Verse: Noise, Noise, Noise Psalm 100:1-4. ESV (other version)*
- 21 *Extra Bible Verse: O LORD of Hosts Isaiah 37:16, ESV*

Bible Truth 2: We Have All Disobeyed God and Deserve His Punishment

- 22 Bible Verse: There Is Not a Righteous Man Ecclesiastes 7:20,29, ESV
- 23 *Extra Bible Verse: Seek the Lord Isaiah 65:6-7, ESV*

Bible Truth 3: God Sent Jesus to Pay for the Sins of God's People

- 24 Bible Verse: He Was Pierced Isaiah 53:5, HCSB
- 25 *Extra Bible Verse: All We Like Sheep Isaiah 53:6 ESV*

Bible Truth 4: God Saves All Who Repent of Their Sins and Trust in Jesus

- 26 Bible Verse: The Time Is Fulfilled Mark 1:15, ESV
- 27 *Extra Bible Verse: The Time Mark 1:15, ESV (other version)*
- 28 *Extra Bible Verse: Everyone Who Names the Name 2 Timothy 2:19,22, ESV*
- 29 *Extra Bible Verse: Help Us, O God of Our Salvation Psalm 79:9, ESV*

listen to or download songs for free at <https://praisefactory.org>: Deep Down Detectives Music page

DEEP DOWN DETECTIVES



Unit 3,

Bible Truth 1

Story Scene Pictures

Using Simple Story Scenes as a Curriculum

Introduce the Key Concept and Bible Verse

Simple Story Scenes give you the basics for the core of your lesson. You can use the overview sheet to introduce and explain the key concept and Bible verse.

Give the Case Assignment

Give the children a Detective Dan listening assignment. Two are provided. You can add a third using the ideas on the bonus, third take-home sheet, if desired. Each listening assignment, let's you teach the story with a different learning emphasis.

Show & Tell the Story

Hold up the pictures and tell the story from the story scenes. Alternatively, you can find in the and Pieces section for this unit at praisefactory.org, these same listening assignments and story scenes, gospel and ACTS prayer modified for view on a screen. Simply download them or open them online and show through your own monitor (tablet, big screen, whatever).

Solve the Case

Repeat Detective Dan's listening assignment question and discuss the answer.

Share the Gospel

Share the gospel tie-in with the kids.

Close in ACTS Prayer

Pray the ACTS prayer with the kids. If using the curriculum with older children, give them a chance to think up their own ACTS tie-ins to the story, using the one provided as cues/ideas for you.

Review Time

Give out the take-home sheet (there are three: two that correlates to the two Detective Dan assignments in the Story Scenes, and a bonus third one.) As the children are coloring, use the take-home sheet discussion questions or your own questions to further review and apply the key concepts, Bible verse, and story truths to the children.

Looking for more?

Online, in the Bits and Pieces section for this unit, you will find review games, crafts, storyboard flannelgraph figures, and audio and sheet music for all of the songs. There are also full lesson plans that offer more of a script and take this curriculum's possibilities to much more depth. Don't forget to tell the parents about the Parents Resources section where they can read through the Story scenes and download take homes with their kids.

Unit 3: The Good News of God, the Gospel

Unit Big Question (and Answer): What Is the Gospel? It's Salvation through Faith in Jesus Christ!

Unit Bible Verse: "For God so loved the world, that he gave his only Son, that whoever believes in him should not perish but have eternal life." John 3:16, ESV

Bible Truth 1 Concept: Salvation through Faith in Jesus Christ...God Made Us and We Should Obey Him

God is our Creator. He made everything in heaven and earth. He made it perfectly. It was good and without sin. It was just exactly as He planned.

God isn't just the Creator of everything. He is also the King over everything. God is the King everyone should obey. God gives us good laws to live by. And, He gives us consequences if we disobey Him. We should worship, love, and obey God, our good Creator and King.

Bible Truth 1 Bible Verse: Psalm 100:1-6, ESV

"Make a joyful noise to the LORD, all the earth! Serve the LORD with gladness! Come into his presence with singing! Know that the LORD, he is God! It is he who made us, and we are his; we are his people, and the sheep of his pasture. Enter his gates with thanksgiving, and his courts with praise!"

Learn a Little: "Know that the LORD, he is God! It is he who made us."

Meaning:

God's people are so happy about being His people! It's not enough for them to quietly worship Him. They want to make a joyful noise and sing loudly to Him. They want everyone--the whole earth--to praise God along with them. They want them to gather together with them at church and sing, sing, sing to the LORD, the great and good king! We can be God's people when we turn away from our sins and trust in Jesus as our Savior.

Bible Truth 1 ACTS Prayer

- A** God, we praise You for being the good Creator and King of the world.
- C** We confess that many times we rebel against You and Your good ways. We choose to live life our own way, instead. We need a Savior!
- T** Thank You for being our good Creator and King. Thank You for making everything in the world for Your good purposes. Thank You for being so merciful to us! Thank You for offering us salvation through Jesus, when we repent of our sins and trust Jesus as our Savior.
- S** God, work in our hearts. Help us to turn away from rebelling against You. Help us to trust in Jesus as our Savior. Help us to joyfully obey You, our good and great King. In Jesus' name we pray. Amen.

Bible Truth 1 Story**The Case of the God Who Was Different**

Acts 17:16-33

Songs Used in Bible Truth 1

Big Question 3 Bible Verse Song: For God So Loved the World John 3:16 ESV

Extra Big Question 3 Bible Verse Song: For God So Loved the World John 3:16 ESV (version 2)

Extra Big Question 3 Bible Verse Song: For God So Loved the World John 3:16 ESV (version 3)

Big Question 3 Hymn: And Can It Be, v.1 Refrain

Big Question 3 Praise Song: I Have Decided to Follow Jesus

Bible Truth 1 Bible Verse Song: Make a Joyful Noise Psalm 100:1-6 ESV

Extra Bible Truth 1 Verse Song: Noise, Noise, Noise Psalm 100:1-4. ESV (other version)

Extra Bible Truth 1 Verse Song: O LORD of Hosts Isaiah 37:16, ESV

listen to or download songs for free at <https://praisefactory.org>: Deep Down Detectives Music page

The Case of the God Who Was Different Acts 17:16-33



Detective Dan's Listening Assignment #1

1. Who was the God who was different?
2. What made Him so different?



Detective Dan's Listening Assignment #2

Psalms 100:3, ESV

"Know that the LORD, he is God! It is he who made us."

1. Who urged the people to worship the LORD and serve Him as their king?
2. Who did worship the LORD? Who did not?

(more listening and discussion questions are included in the curriculum at praisefactory.org)

1. Gods! Gods! Gods! Athens was a city full of fake gods!

On buildings. On hills. Everywhere you looked, there was another god. Apollo and Artemis. Demeter and Dionysius; Pan and Poseidon. Hera and, of course, Zeus, the king of all the Greek gods.

You might not know these names, but the people of Athens certainly did. And these were just a FEW of the HUNDREDS of gods they worshipped! Wow!



Dionysus

Hera Demeter

Zeus

Poseidon

1. Gods! Gods! Gods! Athens was a city full of fake gods! On buildings. On hills. Everywhere you looked, there was another god. Apollo and Artemis. Demeter and Dionysus; Pan and Poseidon. Hera and, of course, Zeus, the king of all the Greek gods. You might not know these names, but the people of Athens certainly did. And these were just a FEW of the HUNDREDS of gods they worshipped! Wow!

2. The people of Athens took good care of their gods. They built them beautiful temples. They laid rich worship gifts at their stony feet. They celebrated them with big worship parties.



2. The people of Athens took good care of their gods. They built them beautiful temples. They laid rich worship gifts at their stony feet. They celebrated them with big worship parties.

3. They even laid a stone to honor an Unknown God. The people of Athens didn't want to leave out any god.



To An Unknown God

3. They even laid a stone to honor an Unknown God. The people of Athens didn't want to leave out any god.

4. Yes, the people of Athens worshipped hundreds of “gods”, but the only God they SHOULD have been worshipping was that “Unknown God.” He was the REAL, the one, TRUE God!

Not many people in Athens knew His name, but I think you do. It was the LORD! He was God, the Father, who sent His Son, Jesus, to be our Savior. He sent His Holy Spirit to live inside those who trusted in Jesus as their Savior. He made the way for us to become His people forever.

What an amazing God was this one, true God! He was not like the fake gods of Athens AT ALL!

THE LORD

4. Yes, the people of Athens worshipped hundreds of “gods”, but the only God they SHOULD have been worshipping was that “Unknown God.” He was the REAL, the one, TRUE God! Not many people in Athens knew His name, but I think you do. It was the LORD! He was God, the Father, who sent His Son, Jesus, to be our Savior. He sent His Holy Spirit to live inside those who trusted in Jesus as their Savior. He made the way for us to become His people forever. What an amazing God was this one, true God! He was not like the fake gods of Athens AT ALL!

5. Maybe the people in Athens didn't know about the one, true God, but there was a man named Paul who did. Paul knew the LORD. He loved Him and lived for Him. He trusted in Jesus, God's Son, as his Savior. The Holy Spirit lived in his heart.

And, if there was ONE thing that Paul wanted to do with his life, it was to tell others how they could know the LORD and trust in Jesus as their Savior, too. So, across the sea, over the mountains, and down through valleys went Paul, telling everyone just that.



5. Maybe the people in Athens didn't know about the one, true God, but there was a man named Paul who did. Paul knew the LORD. He loved Him and lived for Him. He trusted in Jesus, God's Son, as his Savior. The Holy Spirit lived in his heart. And, if there was ONE thing that Paul wanted to do with his life, it was to tell others how they could know the LORD and trust in Jesus as their Savior, too. So, across the sea, over the mountains, and down through valleys went Paul, telling everyone just that.

6. One day, all this traveling led Paul to a city he had never been to before. It was Athens!

Now, Paul had been to many cities that were SMALLER than Athens. And Paul had been to cities that were BIGGER than Athens. But there was something that Paul saw in Athens that he had NEVER seen before in any other city, big or small. It was so many fake gods!

Paul was so upset! Oh, how these people needed to hear about the LORD, the one, true God, and about the Savior, Jesus! They needed to stop worshipping fake gods and start worshipping Him, instead!



6. One day, all this traveling led Paul to a city he had never been to before. It was Athens! Now, Paul had been to many cities that were **SMALLER** than Athens. And Paul had been to cities that were **BIGGER** than Athens. But there was something that Paul saw in Athens that he had **NEVER** seen before in any other city, big or small. It was so many fake gods! Paul was so upset! Oh, how these people needed to hear about the **LORD**, the one, true God, and about the Savior, Jesus! They needed to stop worshipping fake gods and start worshipping Him, instead!

7. Paul decided to do something about that right away!

Paul went to the synagogue-worship place and preached: "The gods of Athens are just fakes. The LORD has sent His Son Jesus to save you, just as He promised. Believe in Him!" he told the people gathered there.

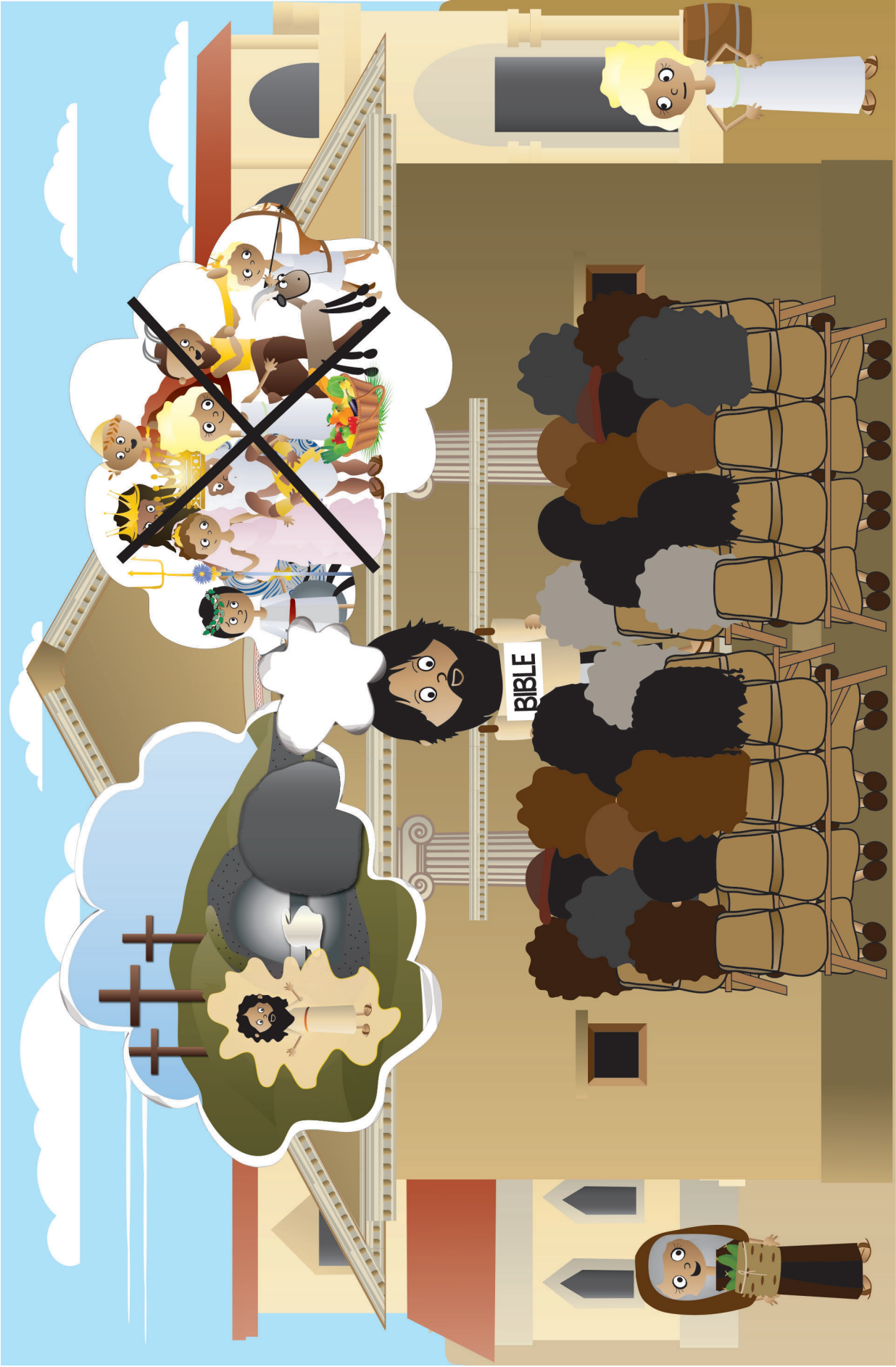

7. Paul decided to do something about that right away! Paul went to the synagogue-worship place and preached: "The gods of Athens are just fakes. The LORD has sent His Son Jesus to save you, just as He promised. Believe in Him!" he told the people gathered there.

8. Then down by the temples and into the marketplace, went Paul. “Let me tell you about the LORD! Let me tell you about Jesus, His Son, sent to save you! Worship Him, not these fake gods!” Paul urged everyone who would listen.



8. Then down by the temples and into the marketplace, went Paul. "Let me tell you about the LORD! Let me tell you about Jesus, His Son, sent to save you! Worship Him, not these fake gods!" Paul urged everyone who would listen.

q. Word about Paul and his strange, new teaching soon spread through Athens and to the city leaders. They found Paul and said, "Come up to our important meeting place on Mars Hill and tell us about this new God. We want to hear about Him, ourselves."

So, up the big, stony hill called Mars Hill went Paul with the city leaders and many others. How excited Paul was to tell them about the real, one, true God and His Son, Jesus! He hoped they would put their trust in Him!



9. Word about Paul and his strange, new teaching soon spread through Athens and to the city leaders. They found Paul and said, “Come up to our important meeting place on Mars Hill and tell us about this new God. We want to hear about Him, ourselves.”

So, up the big, stony hill called Mars Hill with the city leaders and many others. How excited Paul was to tell them about the real, one, true God and His Son, Jesus! He hoped they would put their trust in Him!

10. On top of Mars Hill, Paul spoke to the crowd.

“People of Athens, what a lot of gods you worship! he exclaimed. “But you are worshipping the wrong one! I’ve come to tell you about the one, true God--the one you call “the Unknown God.” His name is the LORD. He’s the One you should worship. He’s the One who made heaven and earth, and everything in it,” Paul told them.



10. On top of Mars Hill, Paul spoke to the crowd. "People of Athens, what a lot of gods you worship! he exclaimed. "But you are worshipping the wrong one! I've come to tell you about the one, true God--the one you call "the Unknown God." His name is the LORD. He's the One you should worship. He's the One who made heaven and earth, and everything in it," Paul told them.

11. “Your city is filled with the big temples you built to worship your gods, but the LORD is too great to live inside even your biggest temple! “ Paul exclaimed.

“You bring worship gifts to take care of your gods. You honor them with worship parties. You keep them looking bright and shiny. You make sure they don’t fall over. But the LORD doesn’t need people to take care of Him,” Paul explained.

“He’s the living God. He takes care of Himself and all of us, too! He made us and gave us life.”



11. “Your city is filled with the big temples you built to worship your gods, but the LORD is too great to live inside even your biggest temple!” Paul exclaimed. “You bring worship gifts to take care of your gods. You honor them with worship parties. You keep them looking bright and shiny. You make sure they don’t fall over. But the LORD doesn’t need people to take care of Him,” Paul explained. “He’s the living God. He takes care of Himself and all of us, too! He made us and gave us life.”

12. “The LORD is our King. We should obey Him and His good laws; but the sad news is, that we don’t. We have all disobeyed Him and deserve His punishment for our sins,” Paul told them.

“But the LORD is so merciful that He made the way for us to be forgiven.” Paul explained. “God sent His Son, Jesus, to suffer and die on the cross to pay for sins. On the third day, He raised up Jesus from the dead in victory.

Now, all who turn away from their sins and trust in Jesus as their Savior can be saved. They can be God’s people and have eternal life with Him,” Paul told them.



12. "The LORD is our King. We should obey Him and His good laws; but the sad news is, that we don't. We have all disobeyed Him and deserve His punishment for our sins," Paul told them. "But the LORD is so merciful that He made the way for us to be forgiven." Paul explained. "God sent His Son, Jesus, to suffer and die on the cross to pay for sins. On the third day, He raised up Jesus from the dead in victory. Now, all who turn away from their sins and trust in Jesus as their Savior can be saved. They can be God's people and have eternal life with Him," Paul told them.

13. “So turn away from worshipping your fake gods. Turn to LORD. Trust in His Son, Jesus, and be saved! You can be God’s people, too,” paul urged them.

The people of Athens hardly knew what to think. They had never heard of a God like this! A God who was supposed to be greater than Zeus, the king of their gods; yet, who came to die for sinners, then rose from the dead! Incredible!



13. "So turn away from worshipping your fake gods. Turn to LORD. Trust in His Son, Jesus, and be saved! You can be God's people, too," Paul urged them.

The people of Athens hardly knew what to think. They had never heard of a God like this! A God who was supposed to be greater than Zeus, the king of their gods; yet, who came to die for sinners, then rose from the dead! Incredible!

14. Many people laughed. “Ha, ha! Your God sounds silly! Who would ever believe in him?” they said.

But others, like Dionysius and Damaris, went to Paul to hear more. As Paul talked, God’s Holy Spirit worked in their hearts. He helped them turn away from their sins and trust in Jesus as their Savior.

How happy Paul was! Maybe there still were many fake gods in Athens, but now there was a little group of believers living there, who could keep on telling others the good news of Jesus.



14. Many people laughed. “Ha, ha! Your God sounds silly! Who would ever believe in him?” they said. But others, like Dionysius and Damaris, went to Paul to hear more. As Paul talked, God’s Holy Spirit worked in their hearts. He helped them turn away from their sins and trust in Jesus as their Savior. How happy Paul was! Maybe there still were many fake gods in Athens, but now there was a little group of believers living there, who could keep on telling others the good news of Jesus.

DDD 3.1

The Case of the God Who Was Different Acts 17:16-33

SOLVED

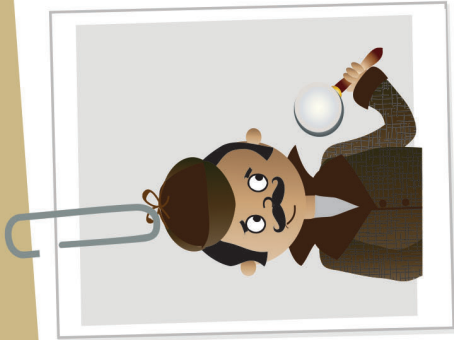

Detective Dan's Listening Assignment #1

1. Who was the God who was different?
The LORD was the god who was so different.
 2. What made Him so different?
He was the one, true, living God. He was no fake god, like those the people of Athens worshipped.
- For You and Me:**
The people of Athens worshipped many gods, but only the LORD was the one, true God who created them and they should obey. Paul told the people of Athens how they could know the LORD as their God, by turning away from worshipping their fake gods and trusting in Jesus as their Savior.



Detective Dan's Listening Assignment #2

Psalim 100:3, ESV

"Know that the LORD, he is God! It is he who made us."

1. Who urged the people to worship the LORD and serve Him as their king?
Paul did.
 2. Who did worship the LORD? Who did not?
Dionysius and Damaris and a few others worshipped the LORD. The rest laughed and kept worshipping their fake gods.
- For You and Me:**
Like the people of Athens, we have so much to worship the LORD for being and doing. He is the one, true God! He has made us and wants us to know Him and love Him. He has offered us to be saved from our sins through Jesus, just like the people of Athens heard.

DDD 3.1

What is the Gospel?

It is Salvation through Faith in Jesus Christ...
God made us and we should obey Him!

The Gospel

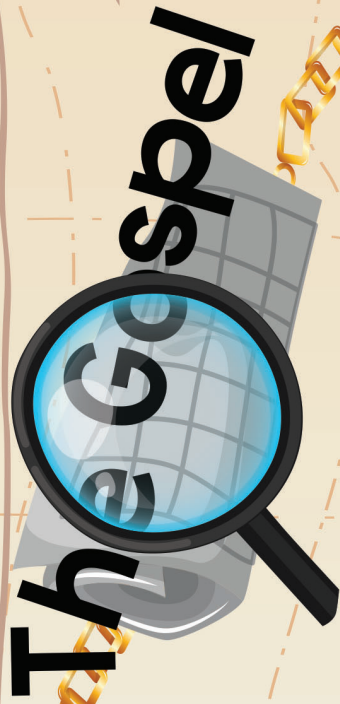

God made all people--including you and me! And He made us to know Him, love Him, and obey Him. He's our good King. But like the people of Athens, we have all disobeyed God. We want to live life our own way, not His. We all deserve His punishment. How sad!

But God is so merciful that He sent a Savior--His Son, Jesus! Jesus suffered and died on the cross. Jesus offered up His perfect life to God to completely pay for the sins of God's people, then He rose from the dead in victory on the third day.

We can be God's people, too, when we turn away from our sins and trust in Jesus as our Savior. He loves to help us do this. Ask Him!

How good is God to us!



DDD 3.1

A Prayer

- A God, we praise You for being the good Creator and King of the world.
- C We confess that many times we rebel against You and Your good ways. We choose to live life our own way. We need a Savior!
- T Thank You for being our good Creator and King. Thank You for making everything in the world for Your good purposes. Thank You for being so merciful to us! Thank You for offering us salvation through Jesus, when we repent of our sins and trust Jesus as our Savior.
- S God, work in our hearts. Help us to turn away from rebelling against You. Help us to trust in Jesus as our Savior. Help us to joyfully obey You, our good and great King.
- In Jesus' name we pray. Amen.



DDD 3.1

DEEP DOWN DETECTIVES



Unit 3,

Bible Truth 2

Story Scene Pictures

Using Simple Story Scenes as a Curriculum

Introduce the Key Concept and Bible Verse

Simple Story Scenes give you the basics for the core of your lesson. You can use the overview sheet to introduce and explain the key concept and Bible verse.

Give the Case Assignment

Give the children a Detective Dan listening assignment. Two are provided. You can add a third using the ideas on the bonus, third take-home sheet, if desired. Each listening assignment, let's you teach the story with a different learning emphasis.

Show & Tell the Story

Hold up the pictures and tell the story from the story scenes. Alternatively, you can find in the and Pieces section for this unit at praisefactory.org, these same listening assignments and story scenes, gospel and ACTS prayer modified for view on a screen. Simply download them or open them online and show through your own monitor (tablet, big screen, whatever).

Solve the Case

Repeat Detective Dan's listening assignment question and discuss the answer.

Share the Gospel

Share the gospel tie-in with the kids.

Close in ACTS Prayer

Pray the ACTS prayer with the kids. If using the curriculum with older children, give them a chance to think up their own ACTS tie-ins to the story, using the one provided as cues/ideas for you.

Review Time

Give out the take-home sheet (there are three: two that correlates to the two Detective Dan assignments in the Story Scenes, and a bonus third one.) As the children are coloring, use the take-home sheet discussion questions or your own questions to further review and apply the key concepts, Bible verse, and story truths to the children.

Looking for more?

Online, in the Bits and Pieces section for this unit, you will find review games, crafts, storyboard flannelgraph figures, and audio and sheet music for all of the songs. There are also full lesson plans that offer more of a script and take this curriculum's possibilities to much more depth. Don't forget to tell the parents about the Parents Resources section where they can read through the Story scenes and download take homes with their kids.

Unit 3: The Good News of God, the Gospel

Unit Big Question (and Answer): What Is the Gospel? It's Salvation through Faith in Jesus Christ!

Unit Bible Verse: "For God so loved the world, that he gave his only Son, that whoever believes in him should not perish but have eternal life." John 3:16, ESV

Bible Truth 2 Concept: Salvation through Faith in Jesus Christ...We Have All Disobeyed God and Deserve His Punishment

God is our good Creator. He made us with a spirit, so we can know and love Him. He is our good King. He gave us good laws that show us how to love Him and love each other. The most wonderful life we can have is knowing and loving God. We were made to know Him and to live as He wants us to live.

But instead of choosing God and His wonderful way of life, we have all chosen to disobey Him and His good laws. We have chosen to live life our own, selfish way, instead. This is what the Bible calls "sin". Because God is good, He hates sin, and He will punish it. And oh, how terrible is God's punishment for sin! It is to live apart from Him and everything good forever! Every single one of us deserve this punishment for our sins.

But God isn't only good; He's merciful, too. Merciful means treating us better than we deserve, and that's just exactly how God offers to treat us. Yes, our sins must be punished, but God has chosen to take that punishment on Himself. That's why He sent Jesus, His own dear Son, to earth. Jesus came to take the punishment we deserved for our sins when He suffered and died on the cross. God promises to forgive all who turn away from their sins and trust in Jesus as their Savior. That can even include you and me! Isn't God amazing? How great is God's love for us!

Bible Truth 2 Bible Verse: Ecclesiastes 7:20,29, ESV

"Surely there is not a righteous man on earth who does good and never sins... See, this alone I found, that God made man upright, but they have sought out many schemes."

Learn a Little: "There is not a righteous man on earth who does good and never sins."

Meaning

In the beginning, God created the heavens and the earth. He created it all good. Oh, how wonderful was the love that those first people had for God! Oh, how wonderful it was to know Him and to obey Him! The big Bible word for loving God and living His good way is "righteous."

But that's not the way things are now. Sadly, we all have chosen to disobey God. We want to do things our own way, not God's good way. We make sneaky schemes and plan how we can get what we want or do what we want, instead of what God wants. Our hearts are not full of love for God or for others as they should be.

No one is righteous anymore. No one, that is, except Jesus, God's Son. God sent Jesus live a perfect, righteous life and give it as the payment for our sins. We can have Jesus' righteousness and become one of God's people, when we turn away from our sins and trust in Jesus as our Savior. God loves to help us do this. Ask Him!

Bible Truth 2 ACTS Prayer

- A** God, we praise You for being the good God who hates sin.
- C** We confess that we have all rebelled against You and Your good ways. We have all chosen to live life our own way instead. We need a Savior!
- T** Thank You for not just being good, but for being merciful, too. Thank You for taking the punishment we deserve on Yourself that we might be saved. Thank You for offering us salvation through Jesus, when we repent of our sins and trust Jesus as our Savior.
- S** God, work in our hearts. Help us to turn away from living against You and Your good ways. Help us to trust in Jesus as our Savior. Help us to love You and know You. Help us to obey Your good laws. In Jesus' name we pray. Amen.

Bible Truth 2 Story**The Case of the Squabbling Brothers and Sisters***Romans*

Songs Used in Bible Truth 2

Big Question 3 Bible Verse Song: For God So Loved the World John 3:16 ESV

Extra Big Question 3 Bible Verse Song: For God So Loved the World John 3:16 ESV (version 2)

Extra Big Question 3 Bible Verse Song: For God So Loved the World John 3:16 ESV (version 3)

Big Question 3 Hymn: And Can It Be, v.1 Refrain

Big Question 3 Praise Song: I Have Decided to Follow Jesus

Bible Truth 2 Bible Verse Song: There Is Not a Righteous Man Ecclesiastes 7:20,29, ESV

Bible Truth 2 Extra Bible Verse Song: Seek the Lord Isaiah 65:6-7, ESV

listen to or download songs for free at <https://praisefactory.org>: Deep Down Detectives Music page

The Case of the Squabbling Brothers and Sisters Romans

Detective Dan's Listening Assignment #1

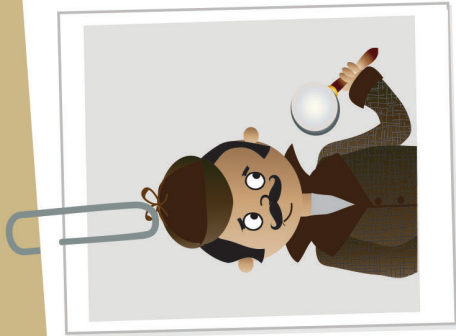

To squabble means to argue about something.

1. Who were the brothers and sisters who were squabbling?
2. What were they squabbling about?

Detective Dan's Listening Assignment #2



Ecclesiastes 7:20, ESV

"There is not a righteous man on earth who does good and never sins."

1. What two kinds of families did the believers in Rome come from?
2. What did they need to remember that would help them stop squabbling with each other?

(more listening and discussion questions are included in the curriculum at praisefactory.org)

I. Squibble, squabble, squibble squabble. The believers in the big city of Rome were fighting with each other: at Priscilla and Aquila's house, and Aristobulus' house, and Narcissus' house, and two other houses.

Little groups of believers gathered to worship God. They were all saved through Jesus. They were all part of God's family. And they should have been loving each other like sisters and brothers; but, they weren't! They were fighting with each other, instead. Squibble, squabble!



1. Squibble, squabble, squibble squabble. The believers in the big city of Rome were fighting with each other: at Priscilla and Aquila's house, and Aristobulus' house, and Narcissus' house, and two other houses. Little groups of believers gathered to worship God. They were all saved through Jesus. They were all part of God's family. And they should have been loving each other like sisters and brothers; but, they weren't! They were fighting with each other, instead. Squibble, squabble!

2. How do you think they were fighting each other? Hitting with their fists? Kicking with their legs? Pulling hair?

No, they weren't fighting like that. But, oh, how they were fighting and hurting each other with the squibble-squabbling words that came out of their mouths!

What was all the fuss about? Well, it had to do with what kind of family you came from -- a family of Jews or a family of Gentiles. Jew and Gentile. Have you ever heard of those Bible family names? Let's find out what they are.

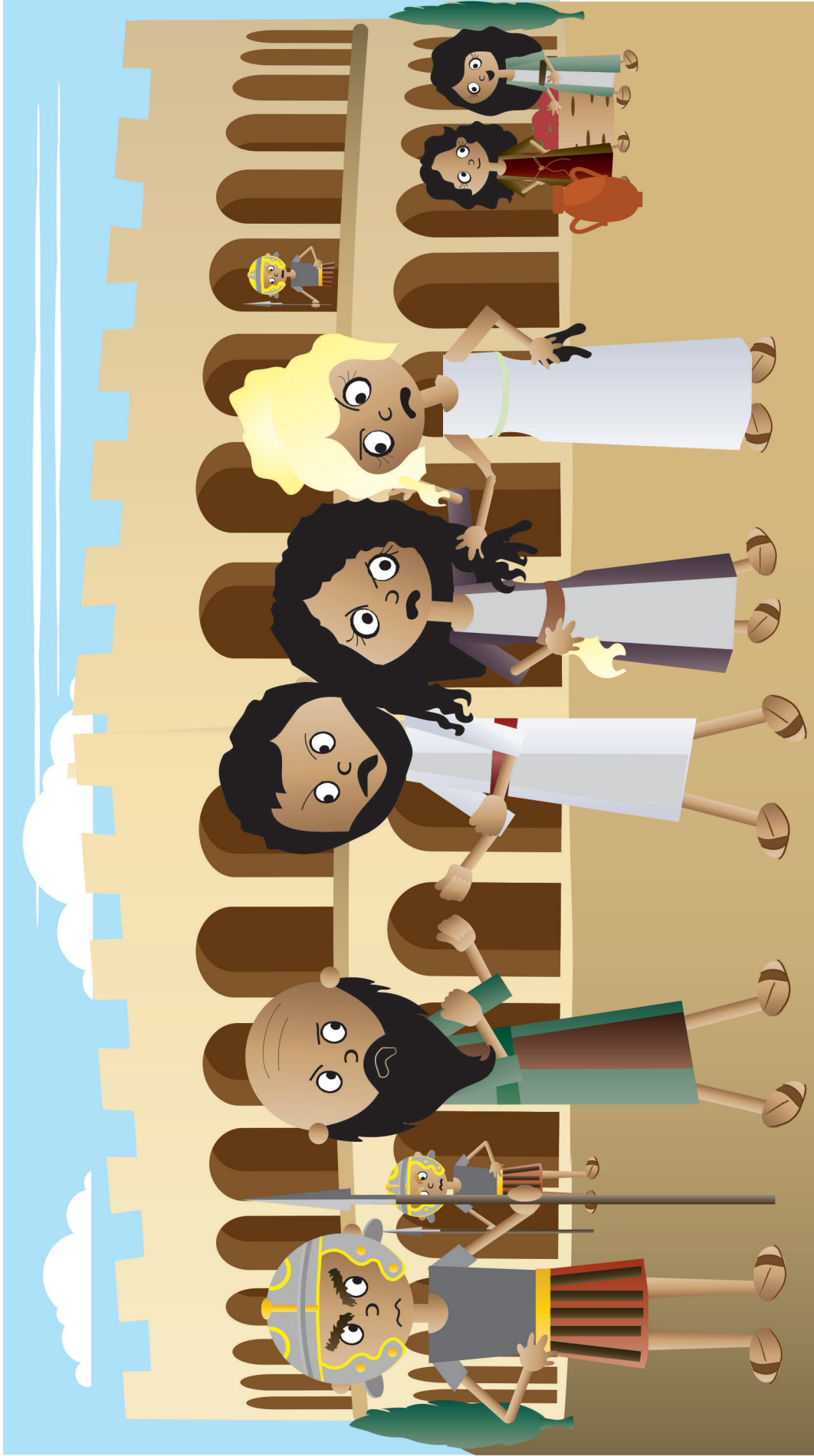

2. How do you think they were fighting each other? Hitting with their fists? Kicking with their legs? Pulling hair? No, they weren't fighting like that. But, oh, how they were fighting and hurting each other with the squibble-squabbling words that came out of their mouths!

What was all the fuss about? Well, it had to do with what kind of family you came from -- a family of Jews or a family of Gentiles. Jew and Gentile. Have you ever heard of those Bible family names? Let's find out what they are.

3. Some of the believers were Jews.

They came from families who worshipped the LORD. They grew up learning the Bible and trying to obey its laws... ALL of them... and there were A LOT! (Laws is another word for rules.)

Let me tell you about them.

THE LORD



Jews



3. Some of the believers were Jews. They came from families who worshipped the LORD. They grew up learning the Bible and trying to obey its laws... ALL of them... and there were A LOT! (Laws is another word for rules.) Let me tell you about them.

4. There were the Ten, Big Laws God gave them. Can you remember the special name of the Ten, Big Laws?

The special name of these laws is the 10 Commandments.

They were the LOVE laws. These laws told how to love God and love one another. That was the FIRST kind of laws that God gave the Jews to obey.

10 Big, Love Laws

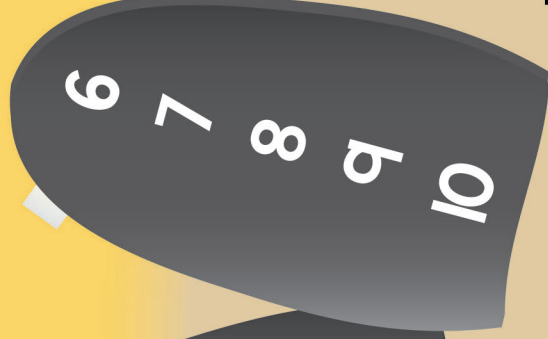
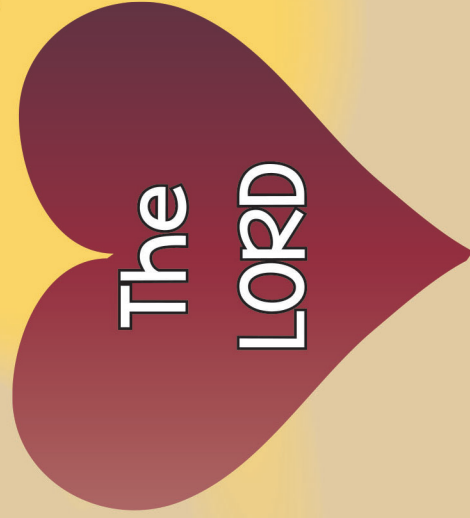

(The 10 Commandments)

4. There were the Ten, Big Laws God gave them. (Can you remember the special name of the Ten, Big Laws?) The special name of these laws is the 10 Commandments. They were the LOVE laws. These laws told how to love God and love one another. That was the FIRST kind of laws that God gave the Jews to obey.

5. But there were more laws than just those! There was a SECOND kind of laws that God gave the Jews.

These were the FRIENDSHIP WITH GOD laws. They told the Jews what worship gifts they needed to give to God when they disobeyed Him. These laws kept them in friendship with God.

Friendship with Good Laws

THE LORD

Your

God



My People



High Priest

5. But there were more laws than just those! There was a **SECOND** kind of laws that God gave the Jews. These were the **FRIENDSHIP WITH GOD** laws. They told the Jews what worship gifts they needed to give to God when they disobeyed Him. These laws kept them in friendship with God.

6. But there were even more laws than those! There was a THIRD kind of laws that God gave the Jews.

These were the LIVE TOGETHER laws. These told the Jews how to live their everyday lives--what clothes they should wear; what food they should eat; how to take care of sick people; what to do when they had arguments; and, other everyday things like that.

What a lot of laws God gave the Jews! But He had a good purpose for them all. These laws helped everyone know what God is like. And, they helped everyone see that the Jews were God's special people, living His way, and waiting for Him to send the Savior one day.

Live Together Laws



6. But there were even more laws than those! There was a THIRD kind of laws that God gave the Jews. These were the LIVE TOGETHER laws. These told the Jews how to live their everyday lives--what clothes they should wear; what food they should eat; how to take care of sick people; what to do when they had arguments; and, other everyday things like that.

What a lot of laws God gave the Jews! But He had a good purpose for them all. These laws helped everyone know what God is like. And, they helped everyone see that the Jews were God's special people, living His way, and waiting for Him to send the Savior one day.

7. And at just the right time, God DID send the Savior--Jesus!

Jesus lived a perfect life. He kept all of God's good laws. Then, He suffered and died on the cross, giving His life as the final, perfect, worship gift that paid for sins. On the third day, Jesus rose from the dead, showing that He had beaten sin and death for all who would turn away from their sins and trust in Him as their Savior.

Jesus had made the way for us to be friends with God!

Jesus Kept God's Laws Perfectly



Jesus Beat Sin & Death for God's People



7. And at just the right time, God DID send the Savior--Jesus! Jesus lived a perfect life. He kept all of God's good laws. Then, He suffered and died on the cross, giving His life as the final, perfect, worship gift that paid for sins. On the third day, Jesus rose from the dead, showing that He had beaten sin and death for all who would turn away from their sins and trust in Him as their Savior. Jesus had made the way for us to be friends with God!

8. When these Jews heard the good news of Jesus, they were so happy.

Here was the Savior they had been waiting for! He had paid for their sins! They trusted in Him as their Savior. Now they were God's people, saved through Jesus.

There is the special name for people who have Jesus as their Savior. Do you know what it is? They are called Christians. And so now, these Jews weren't just Jews anymore. Now, they were Christians.

Jewish Christians

GOOD NEWS



8. When these Jews heard the good news of Jesus, they were so happy. Here was the Savior they had been waiting for! He had paid for their sins! They trusted in Him as their Savior. Now they were God's people, saved through Jesus. There is the special name for people who have Jesus as their Savior. Do you know what it is? They are called Christians. And so now, these Jews weren't just Jews anymore. Now, they were Christians.

q. But what should these Jewish Christians do with all those laws from God's Word? They had obeyed them for so long! Should they keep on obeying them now that Jesus had come? They thought about this A LOT!

Let's see... well, they KNEW they should keep on obeying God's Ten, Big, Love laws--the 10 Commandments. They still needed to keep on loving God and others, like the LOVE laws taught. That was clear.

Jewish Christians 10 Big, Love Laws



The LORD

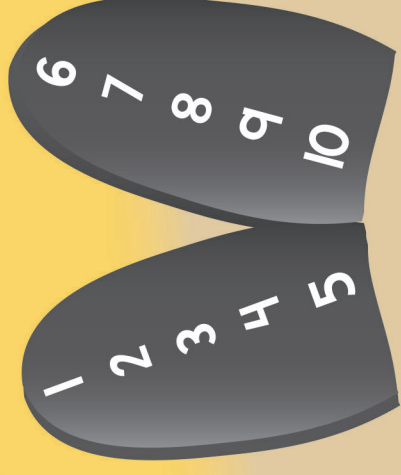

YES!!!

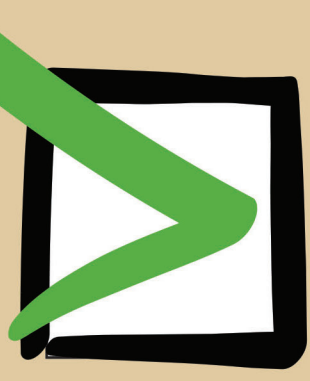

q. But what should these Jewish Christians do with all those laws from God's Word? They had obeyed them for so long! Should they keep on obeying them now that Jesus had come? They thought about this A LOT! Let's see... well, they KNEW they should keep on obeying God's Ten, Big, Love laws—the 10 Commandments. They still needed to keep on loving God and others, like the LOVE laws taught. That was clear.

10. And, they KNEW that Jesus had paid for their sins. His life had been the final worship gift. He gave them FOREVER friendship with God.

So, they did NOT have to keep the FRIENDSHIP WITH GOD laws anymore.

Friendship with God Laws

Jewish
Christians



THE LORD

Your
God



My People

no!!!



High Priest

10. And, they **KNEW** that Jesus had paid for their sins. His life had been the final worship gift. He gave them **FOREVER** friendship with God. So, they did **NOT** have to keep the **FRIENDSHIP WITH GOD** laws anymore.

II. But what about all those LIVE TOGETHER laws? The ones about what Jews should eat and drink and do in their everyday lives? The Savior Jesus had come. Now, they were Christians. Were they supposed to keep on living together like Jews, too?

Live Together Laws

Jewish
Christians



II. But what about all those LIVE TOGETHER laws? The ones about what Jews should eat and drink and do in their everyday lives? The Savior Jesus had come. Now, they were Christians. Were they supposed to keep on living together like Jews, too?

12. Many of the Jews LIKED those LIVE TOGETHER laws. Actually, they LOVED them. They didn't want to get rid of them... and they wanted everyone else to keep them, too.

They thought EVERYONE should become a Christian, saved through Jesus; but, they should also keep on living together like Jews... EVEN the people who didn't grow up as Jews!

Uh oh, that might just cause a problem or two, especially for the believers who came from that OTHER kind of Bible family-- the Gentiles. Let me tell you about them.

Live Together Laws

Jewish
Christians

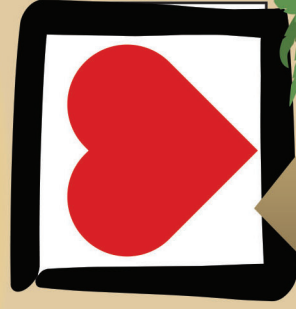

Gentile
Christians



12. Many of the Jews **LIKED** those **LIVE TOGETHER** laws. Actually, they **LOVED** them. They didn't want to get rid of them... and they wanted everyone else to keep them, too. They thought **EVERYONE** should become a Christian, saved through Jesus; but, they should also keep on living together like Jews... **EVEN** the people who didn't grow up as Jews! Uh oh, that might just cause a problem or two, especially for the believers who came from that **OTHER** kind of Bible family--- the Gentiles. Let me tell you about them.

13. Gentiles came from families who had NOT grown up knowing the Bible or keeping its laws--not the Ten, Big, Love laws or the Friendship with God laws, or even the Live Together laws.

They had grown up worshipping fake gods. And actually, worshipping those fake gods meant doing some bad things that disobeyed God's good laws--like the big, worship parties they had for them.



13. Gentiles came from families who had NOT grown up knowing the Bible or keeping its laws—not the Ten, Big, Love laws or the Friendship with God laws, or even the Live Together laws. They had grown up worshipping fake gods. And actually, worshipping those fake gods meant doing some bad things that disobeyed God's good laws--like the big, worship parties they had for them.

14. But when these Gentiles heard the good news of Jesus, they left their fake gods behind. They trusted in Jesus as their Savior, and they wanted to live God's way now. They became Christians.

They gathered as a church with the Jewish believers. And as they listened to God's Word, they heard all about all those laws for the first time.

Now everyone had a question... The question was: what should they --the people from Gentile families-- do with all of those laws?

Gentile

GOOD NEWS

Christians



14. But when these Gentiles heard the good news of Jesus, they left their fake gods behind. They trusted in Jesus as their Savior, and they wanted to live God's way now. They became Christians. They gathered as a church with the Jewish believers. And as they listened to God's Word, they heard all about all those laws for the first time. Now everyone had a question... The question was: what should they --the people from Gentile families-- do with all of those laws?

15. Like the Jewish Christians, the Gentile Christians KNEW that they should obey God's Ten, Big, Love laws--the 10 Commandments. They still needed to keep on loving God and others, like those LOVE laws taught. That was clear.

10 Big, Love Laws

Gentile Christians

The LORD

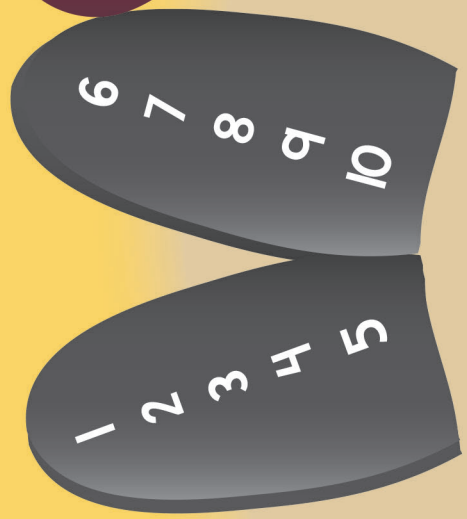

YES!!!

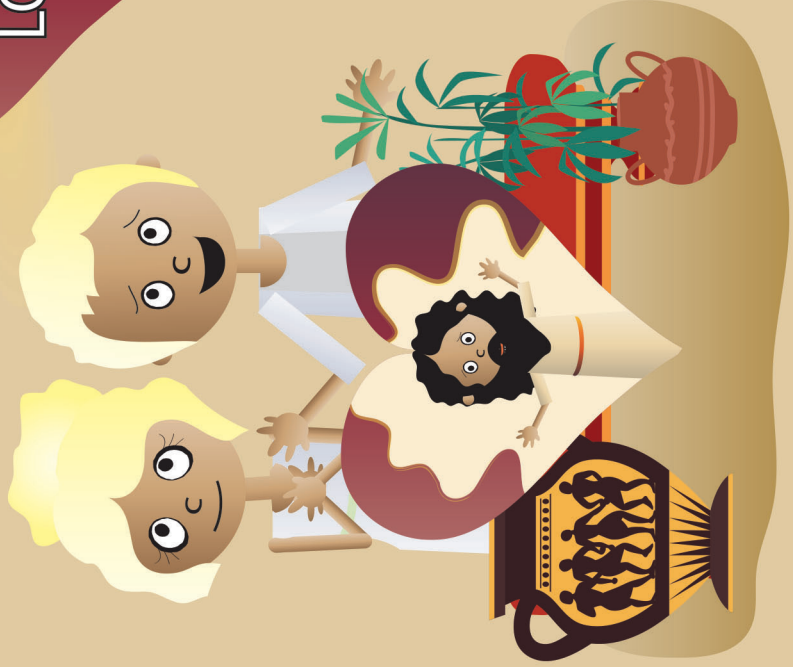
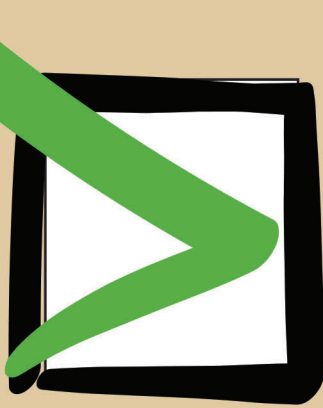

15. Like the Jewish Christians, the Gentile Christians KNEW that they should obey God's Ten, Big, Love laws—the 10 Commandments. They still needed to keep on loving God and others, like those LOVE laws taught. That was clear.

16. And like the Jewish Christians, they KNEW that Jesus had paid for their sins. His life had been the final worship gift. He gave them FOREVER friendship with God. So, they did NOT have to keep the FRIENDSHIP WITH GOD laws anymore.

Friendship with God Laws

Gentile
Christians



THE
LORD



My People

no!!!



High Priest

16. And like the Jewish Christians, they KNEW that Jesus had paid for their sins. His life had been the final worship gift. He gave them FOREVER friendship with God. So, they did NOT have to keep the FRIENDSHIP WITH GOD laws anymore.

17. But what about those LIVE TOGETHER laws? The laws that told the Jews how to live together.

The Savior had come. Surely, Gentiles didn't need to obey THOSE laws! Surely, they didn't need to live like Jews to be Christians! That didn't make sense! They were saved through Jesus, not those laws!

Nope. They would NOT obey the LIVE TOGETHER laws. No way! And so, came all of the squibble-squabbling.

Live Together Laws

Gentile
Christians

 no!!!



17. But what about those LIVE TOGETHER laws? The laws that told the Jews how to live together. The Savior had come. Surely, Gentiles didn't need to obey THOSE laws! Surely, they didn't need to live like Jews to be Christians! That didn't make sense! They were saved through Jesus, not those laws! Nope. They would NOT obey the LIVE TOGETHER laws. No way! And so, came all of the squabble-squabbling.

18. “We’re better than you, Gentiles,” the Jewish Christians said.

“Long ago, God chose US to be His special people through Abraham. He chose US to write down the Bible, His Word. He gave US the great promises about the Savior Jesus coming. Jesus came from OUR family. He was a Jew! God gave US His good laws–the LOVE laws and the FRIENDSHIP WITH GOD laws and the LIVE TOGETHER laws. All of them!”

“We obey them, and so should you! That’s what God’s people have always done,” they told the Gentiles.

Jews Are Best



**We THINK
Gentiles...**

**need to live
like Jews!**

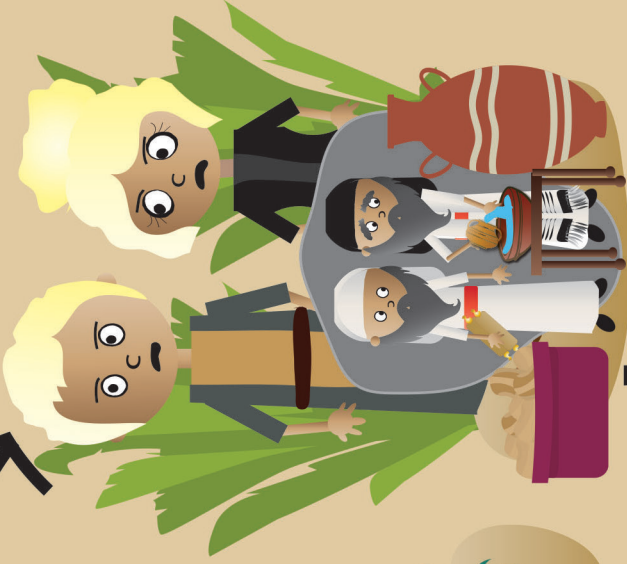

Gentiles

Jews

18. "We're better than you, Gentiles," the Jewish Christians said. "Long ago, God chose US to be His special people through Abraham. He chose US to write down the Bible, His Word. He gave US the great promises about the Savior Jesus coming. Jesus came from OUR family. He was a Jew! God gave US His good laws—the LOVE laws and the FRIENDSHIP WITH GOD laws and the LIVE TOGETHER laws. All of them! We obey them, and so should you! That's what God's people have always done," they told the Gentiles.

19. “You are NOT better than us!” the Gentile Christians squabbled back.

“Yes, you’re right. Long ago, you Jews WERE chosen to be God’s special people. But now, many people from your family don’t even believe in Jesus.”

“Maybe we ARE just Gentiles. Maybe our families didn’t come from God’s special people, long ago. But we believe in the Savior Jesus NOW! And a lot more of US believe in Him than you, Jews! Look who God is choosing to make into His special people NOW – it’s us, Gentiles.”

“And we DON’T have to keep all of your Live Together Laws!” they squabbled back.

Gentiles Are Best



**We THINK DON'T
Gentiles... need to live
like Jews!**

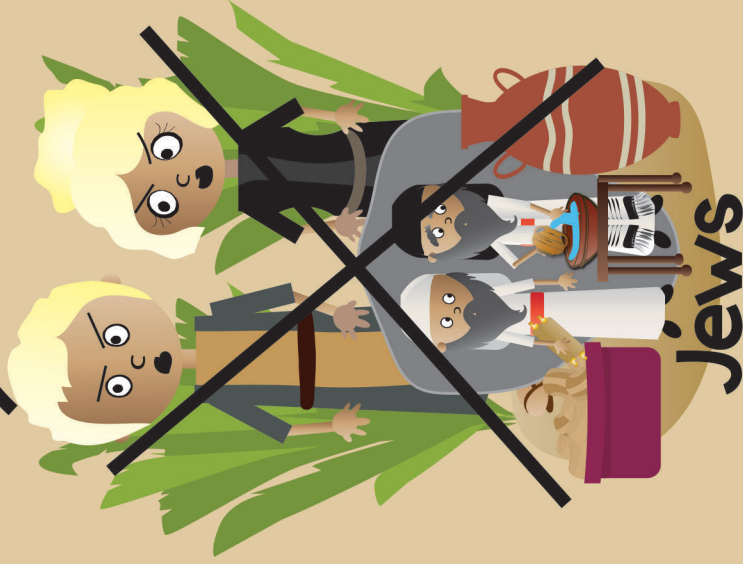

19. "You are NOT better than us!" the Gentile Christians squabbled back. "Yes, you're right. Long ago, you Jews WERE chosen to be God's special people. But now, many people from your family don't even believe in Jesus. Maybe we ARE just Gentiles. Maybe our families didn't come from God's special people, long ago. But we believe in the Savior Jesus NOW! And a lot more of US believe in Him than you, Jews! Look who God is choosing to make into His special people NOW – it's us, Gentiles. And we DON'T have to keep all of your Live Together Laws!" they squabbled back.

20. Far away in the city of Corinth, Paul heard about these squabbles.

Paul had come from a Jewish family. He had grown up reading the Bible and learning God's laws. He had tried as hard as he could to keep them all, but he could never obey them as God required.

Nope, if there was one thing Paul knew, it was only by trusting in Jesus as their Savior that ANYONE can be forgiven of their sins. That was the only way to become one of God's people.

These believers needed to remember this; so, Paul decided to do something about it.



20. Far away in the city of Corinth, Paul heard about these squabbles. Paul had come from a Jewish family. He had grown up reading the Bible and learning God's laws. He had tried as hard as he could to keep them all, but he could never obey them as God required. Nope, if there was one thing Paul knew, it was only by trusting in Jesus as their Savior that ANYONE can be forgiven of their sins. That was the only way to become one of God's people. These believers needed to remember this; so, Paul decided to do something about it.

21. He would write them a letter.

“Help me write to the believers in Rome,” Paul asked his friend, Tertius. So, Tertius got out his scroll and wrote down Paul’s words:

“Dear believers in Rome,

I thank God for saving you. I can’t wait for the day when I will get to see you, and we can encourage each other in our faith in God. God has given me the job of preaching to all of you --both Jews and Gentiles. One day, I hope to come and preach more of the good news of Jesus to you in Rome, face-to-face,” Paul told the Romans.



21. He would write them a letter. "Help me write to the believers in Rome," Paul asked his friend, Tertius. So, Tertius got out his scroll and wrote down Paul's words: "Dear believers in Rome, I thank God for saving you. I can't wait for the day when I will get to see you, and we can encourage each other in our faith in God. God has given me the job of preaching to all of you --both Jews and Gentiles. One day, I hope to come and preach more of the good news of Jesus to you in Rome, face-to-face," Paul told the Romans.

22. “I know you are squabbling about who comes from a better family--the Jews or the Gentiles,” he wrote. “I know you are squabbling about the Live Together Laws from God’s Word.

But remember: EVERYONE has sinned against God, both Jews and Gentiles. None of us is righteous. None of us does what is good and never sins. NO ONE! We all deserve God’s punishment.”



22. "I know you are squabbling about who comes from a better family--the Jews or the Gentiles," he wrote. "I know you are squabbling about the Live Together Laws from God's Word. But remember: **EVERYONE** has sinned against God, both Jews and Gentiles. None of us is righteous. None of us does what is good and never sins. **NO ONE!** We all deserve God's punishment."

23. “Jews: God may have chosen your family to write down His Word, the Bible. He may have given your family His laws to live by. But you couldn’t obey them all, could you? You were all law breakers! You needed a Savior -- Jesus -- to save you from your sins. Be thankful, not proud!”

“And you, Gentiles: Yes, maybe a lot more people from your Gentile families are trusting in Jesus^{RD3} as their Savior than the Jews these days. But it’s not because Gentiles are better than Jews. It’s only because God has been kind enough to save you through Jesus, too. Be thankful, not proud!”



23. “Jews: God may have chosen your family to write down His Word, the Bible. He may have given your family His laws to live by. But you couldn’t obey them all, could you? You were all law breakers! You needed a Savior --Jesus-- to save you from your sins. Be thankful, not proud! And you, Gentiles: Yes, maybe a lot more people from your Gentile families are trusting in Jesus as their Savior than the Jews these days. But it’s not because Gentiles are better than Jews. It’s only because God has been kind enough to save you through Jesus, too. Be thankful, not proud!”

24. “You are ALL part of God’s family. The Holy Spirit lives in ALL of you. Stop your squibble- squabbling!”

“Love each other like sisters and brothers should. Use the gifts God has given each of you to care for each other, and to show others how great God is. Praise God together with me! He gives us everything we need through Jesus, our Savior.”

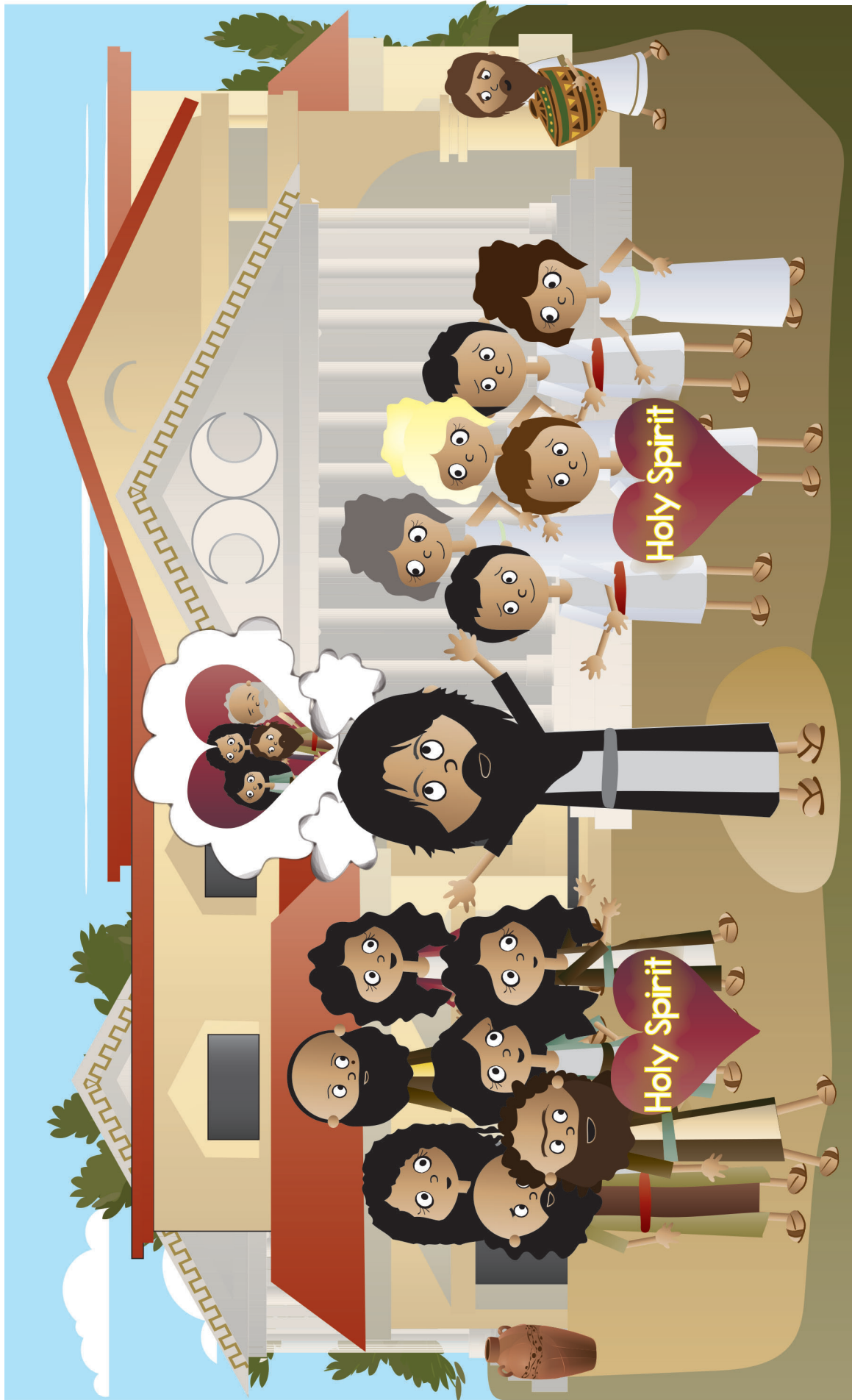

24. "You are ALL part of God's family. The Holy Spirit lives in ALL of you. Stop your squabble-squabbling! Love each other like sisters and brothers should. Use the gifts God has given each of you to care for each other, and to show others how great God is. Praise God together with me! He gives us everything we need through Jesus, our Savior."

25. Paul rolled up the letter and gave it to Phoebe to take to the believers in faraway Rome.

What happened when Paul's letter was read to the believers in Rome? We don't really know. The Bible doesn't tell us.

How Paul hoped it would help them remember that they ALL needed Jesus to be their Savior! How he hoped it would stop their squibble-squabbling over who is best and over those LIVE TOGETHER laws!

Paul wanted them to love God and love one another. He wanted them to live out the good news of Jesus together, and share it with others. I hope that's what they did.

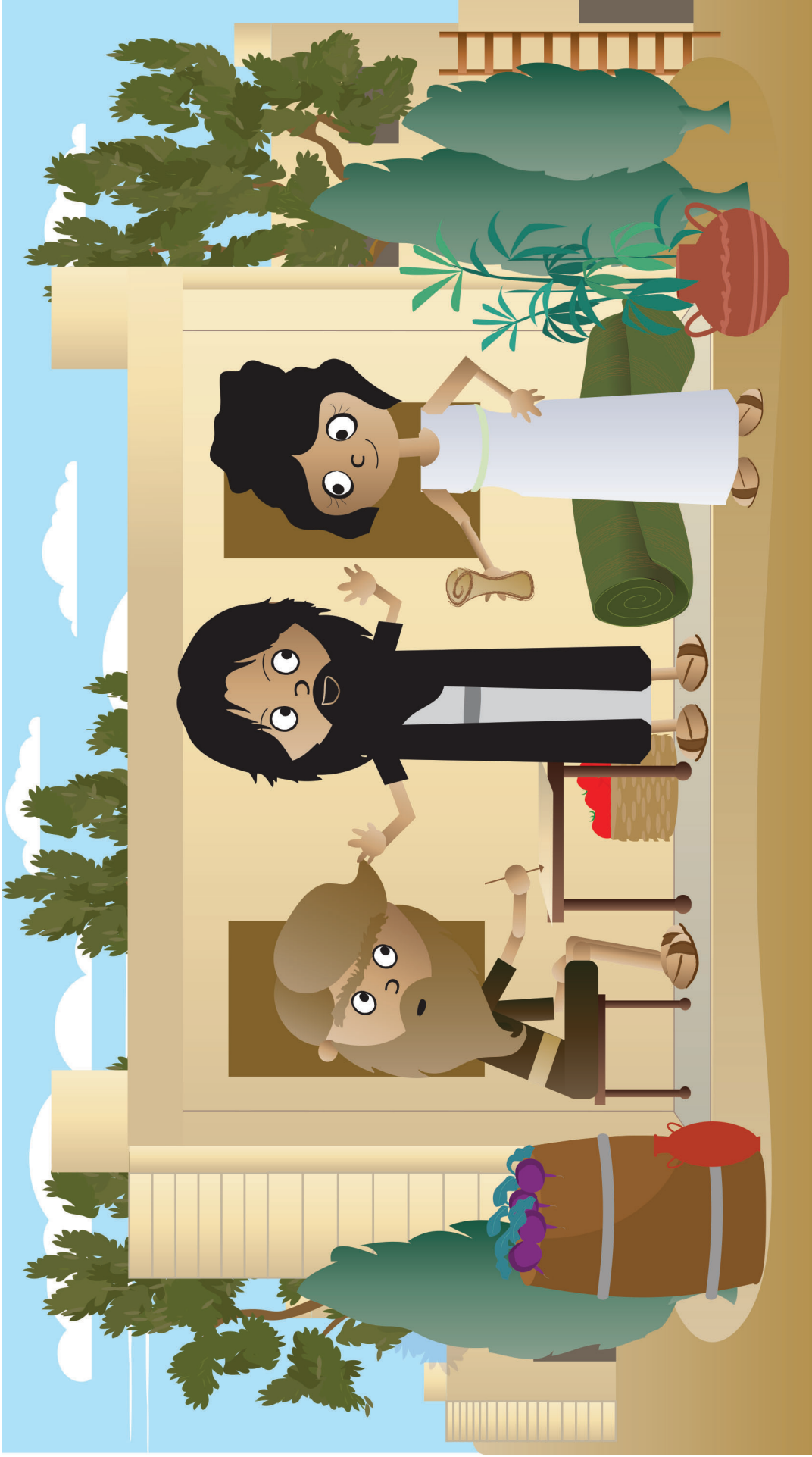

25. Paul rolled up the letter and gave it to Phoebe to take to the believers in faraway Rome. What happened when Paul's letter was read to the believers in Rome? We don't really know. The Bible doesn't tell us. How Paul hoped it would help them remember that they ALL needed Jesus to be their Savior! How he hoped it would stop their squibble-squabbling over who is best and over those LIVE TOGETHER laws! Paul wanted them to love God and love one another. He wanted them to live out the good news of Jesus together, and share it with others. I hope that's what they did.

DDD 3.2

The Case of the Squabbling Brothers and Sisters Romans Romans

SOLVED



Detective Dan's Listening Assignment #1

To squabble means to argue about something.

1. Who were the brothers and sisters who were squabbling?
The believers in Rome.
2. What were they squabbling about?
They were squabbling about who was best--the Jews or the Gentiles. And, if all believers should keep the Live Together laws of the Jews.

For You and Me:
Just like the believers in Rome, we need to remember that it is only through God's free gift of forgiveness through Jesus that anyone can become one of God's people. This can be His gift to us, too, if we turn away from our sins and trust in Jesus as our Savior.



Detective Dan's Listening Assignment #2

Ecclesiastes 7:20, ESV

"There is not a righteous man on earth who does good and never sins."

1. What two kinds of families did the believers in Rome come from? From Jew and Gentile families.
2. What did they need to remember that would help them stop squabbling with each other?
That none of them had been righteous. None of them had pleased God by their own, good works. They were saved only through the Savior, Jesus. That's what mattered. Not the Live-Together Laws.

For You and Me:
None of us can ever be good enough to please God. None of us would ever be able to know God or be His people on our own. But the good news is that Jesus did live a perfect life. He offered up His righteous to pay for the sins of God's people, all who turn away from their sins and trust in Jesus as their Savior. God loves to help us do this. Ask Him!

DDD 3.2

What is the Gospel?

It is Salvation through Faith in Jesus Christ... we have all disobeyed God and deserve His punishment!

The Gospel

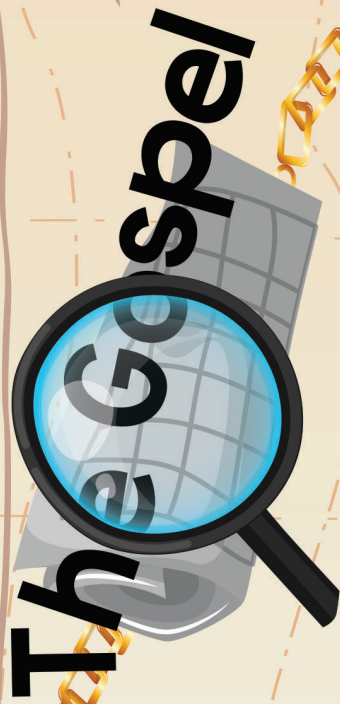

Did you know that Paul's letter to those believers in Rome became part of God's Word, the Bible? Many people have read his letter to those people in Rome and learned from it. Why, even you are learning from it today!

One of the most important things we can learn from Paul's letter is that we are lawbreakers who have chosen to disobey God. We all deserve God's punishment.

But God is so merciful that He sent a Savior --His Son, Jesus! Jesus suffered and died on the cross, offering up His perfect life to God as full payment for the sins of God's people. He rose from the dead in victory on the third day.

We all need to turn away from our sins and trust in Jesus as our Savior. And if we do, God will forgive us and make us His people forever!



DDD 3.2

A Prayer

A God, we praise You for being the good God who hates sin.

C We confess that we have all rebelled against You and Your good ways. We have all chosen to live life our own way instead. We need a Savior!

T Thank You for not just being good, but for being merciful, too. Thank You for taking the punishment that sinful people like us deserve on Yourself that we might be saved. Thank You for offering us salvation through Jesus, when we repent of our sins and trust Jesus as our Savior.

S God, work in our hearts. Help us to turn away from living against You and Your good ways. Help us to trust in Jesus as our Savior. Help us to love You and know You. Help us to obey Your good laws.

In Jesus' name we pray. Amen.



DDD 3.2

DEEP DOWN DETECTIVES



Unit 3,

Bible Truth 3

Story Scene Pictures

Using Simple Story Scenes as a Curriculum

Introduce the Key Concept and Bible Verse

Simple Story Scenes give you the basics for the core of your lesson. You can use the overview sheet to introduce and explain the key concept and Bible verse.

Give the Case Assignment

Give the children a Detective Dan listening assignment. Two are provided. You can add a third using the ideas on the bonus, third take-home sheet, if desired. Each listening assignment, let's you teach the story with a different learning emphasis.

Show & Tell the Story

Hold up the pictures and tell the story from the story scenes. Alternatively, you can find in the and Pieces section for this unit at praisefactory.org, these same listening assignments and story scenes, gospel and ACTS prayer modified for view on a screen. Simply download them or open them online and show through your own monitor (tablet, big screen, whatever).

Solve the Case

Repeat Detective Dan's listening assignment question and discuss the answer.

Share the Gospel

Share the gospel tie-in with the kids.

Close in ACTS Prayer

Pray the ACTS prayer with the kids. If using the curriculum with older children, give them a chance to think up their own ACTS tie-ins to the story, using the one provided as cues/ideas for you.

Review Time

Give out the take-home sheet (there are three: two that correlates to the two Detective Dan assignments in the Story Scenes, and a bonus third one.) As the children are coloring, use the take-home sheet discussion questions or your own questions to further review and apply the key concepts, Bible verse, and story truths to the children.

Looking for more?

Online, in the Bits and Pieces section for this unit, you will find review games, crafts, storyboard flannelgraph figures, and audio and sheet music for all of the songs. There are also full lesson plans that offer more of a script and take this curriculum's possibilities to much more depth. Don't forget to tell the parents about the Parents Resources section where they can read through the Story scenes and download take homes with their kids.

Unit 3: The Good News of God, the Gospel

Unit Big Question (and Answer): What Is the Gospel? It's Salvation through Faith in Jesus Christ!

Unit Bible Verse: "For God so loved the world, that he gave his only Son, that whoever believes in him should not perish but have eternal life." John 3:16, ESV

Bible Truth 3 Concept: Salvation through Faith in Jesus Christ...God Sent Jesus to Pay for the Sins of God's People!

What a mess we have made in God's good world! God is our good Maker and King, yet we have all chosen to disobey Him. Because God is good, He hates sin and He is right to punish our sins. We certainly deserve it! The punishment for sins is death--being separated from God and all His goodness forever. How sad!

But God is not only good; He is also very merciful. He treats us better than we deserve. That's why God, Himself, made a way for us to be forgiven our sins and to become His people. God sent His own, dear Son, Jesus, to live the perfect life of love and obedience that we should live, but never do. On the cross, Jesus offered His perfect life to God as the full payment for sins, for all who turn away from their sins and trust in Him as their Savior. Jesus suffered and died in our place. Then on the third day, Jesus rose up from the dead, showing that He had really beaten sin and death! Jesus can be our Savior, too, when we turn away from our sins and trust in Him as our Savior.

Bible Truth 3 Bible Verse: Isaiah 53:5-6, ESV

"He was pierced for our transgressions, he was crushed for our iniquities; the punishment that brought us peace was upon him, and by his wounds we are healed. We all, like sheep, have gone astray, each of us has turned to his own way; and the LORD has laid on him the iniquity of us all."

Learn a Little: "The punishment that brought us peace was upon him."

Meaning

God is our good King and Creator and we should love and obey Him. But the sad news is that we all choose to disobey Him...and we all deserve His punishment.

Yes, we deserve His punishment, but God has loved us so much that He sent His Son, Jesus, to take the punishment that we deserve instead. Jesus lived a perfect life and chose to give it up to pay for our sins. On the cross, He suffered and died. He was pierced with nails in His hands and feet. He was pierced in His side with a sword. He took all of the punishment that we deserve from God for our sins so that we could be forgiven. Jesus made the way for us to have peace with God by suffering in our place.

Who did Jesus do this for? It is God's free gift to all who put their trust in Jesus as their Savior and choose to live for Him. This gift can be for you, too! Ask God to help you. He loves to answer this prayer!

Bible Truth 3 ACTS Prayer

- A** God, we praise You for being the good Creator and King of the world.
- C** God, we confess rebelling against You and Your good ways. Too many times we choose to live life our own way instead of Yours. We need a Savior!
- T** Thank You for being our good Creator and King. Thank You for making everything in the world for Your good purposes. Thank You for being so merciful to us! Thank You for offering us salvation through Jesus, when we repent of our sins and trust Jesus as our Savior.
- S** God, work in our hearts. Help us to turn away from disobeying You. Help us to trust in Jesus as our Savior. Help us to obey Your good ways and bring You glory. In Jesus' name we pray. Amen.

Bible Truth 3 Story

The Case of the Savior, from Start to Finish *Genesis; The Gospels*

Songs Used in Bible Truth 3

Big Question 3 Bible Verse Song: For God So Loved the World John 3:16 ESV

Extra Big Question 3 Bible Verse Song: For God So Loved the World John 3:16 ESV (version 2)

Extra Big Question 3 Bible Verse Song: For God So Loved the World John 3:16 ESV (version 3)

Big Question 3 Hymn: And Can It Be, v.1 Refrain

Big Question 3 Praise Song: I Have Decided to Follow Jesus

Bible Truth 3 Bible Verse Song: He Was Pierced Isaiah 53:5, HCSB

Bible Truth 3 Extra Bible Verse Song: All We Like Sheep Isaiah 53:6, ESV

listen to or download songs for free at <https://praisefactory.org>: Deep Down Detectives Music page

The Case of the Savior, from Start to Finish Genesis, The Gospels



Detective Dan's Listening Assignment #1

1. Who was the Savior?
2. When did the promise of a Savior start? When did it finish?



Detective Dan's Listening Assignment #2

Isaiah 53:5, ESV

"He was pierced for our transgressions, he was crushed for our iniquities; the punishment that brought us peace was upon him."

Transgressions and iniquities are other words for sin.

1. Whose transgressions and iniquities deserved God's punishment in our story?
2. Who came to take God's punishment for them?

(more listening and discussion questions are included in the curriculum at praisefactory.org)

1. Back in the very beginning, God created our world. Heavens and earth, sky and seas. Mountains and valleys, flowers and trees. Birds, fish, and animals, too. Then, best of all, God made people, like me and you. And it was all good. VERY good.

Why were people the best of all that God created? Because God created people with something that no other earth creature had. He gave us a living spirit that could know and love Him. That meant people could have a special closeness with God that no one else could enjoy!



I. Back in the very beginning, God created our world. Heavens and earth. Sky and seas. Mountains and valleys, Flowers and trees, Birds, fish and animals, too. And best of all, God made people, like me and you. And it was all good. VERY good.

Why were people the best of all that God created? Because God created people with something that no other earth creature had. He gave us a living spirit that could know and love Him. That meant people could have a special closeness with God that no one else could enjoy!

2. I'm sure it's very fine to be a fast horse galloping across a grassy field; or, a proud eagle soaring on the wind, high up in the sky.

I'm sure it would be marvelous to twist and spin like a dolphin in the ocean. And don't we all enjoy looking up at the beautiful stars at night or gazing at tall, snowy mountains in the distance?

But NONE of this is ANYTHING as great as knowing God and being close to Him. That is the BEST thing anyone can ever enjoy. And that's why the spirit God put inside people makes us so very special, indeed!



2. I'm sure it's very fine to be a fast horse galloping across a grassy field; or, a proud eagle soaring on the wind, high up in the sky. I'm sure it would be marvelous to twist and spin like a dolphin in the ocean. And don't we all enjoy looking up at the beautiful stars at night or gazing at tall, snowy mountains in the distance? But **NONE** of this is **ANYTHING** as great as knowing God and being close to Him. That is the **BEST** thing anyone can ever enjoy. And that's why the spirit God put inside people makes us so very special, indeed!

3. God named the first man and woman, Adam and Eve. He gave them a beautiful garden home with everything they needed-- perfect food to eat, perfect jobs to do, and perfect friendship to enjoy with each other.

But the best thing about life in that special garden wasn't anything that Adam and Eve could put in their mouths, or do with their hands, or even enjoy with each other. The best thing was something they couldn't even see or touch. And it all had to do with that spirit God gave them.



3. God named the first man and woman, Adam and Eve. He gave them a beautiful garden home with everything they needed-- perfect food to eat, perfect jobs to do, and perfect friendship to enjoy with each other.

But the best thing about life in that special garden wasn't anything that Adam and Eve could put in their mouths, or do with their hands, or even enjoy with each other. The best thing was something they couldn't even see or touch. And it all had to do with that spirit God gave them.

4. The best thing in that garden was the very special closeness Adam and Eve had with God. It was “Perfect Wonderfulness.”

It was “Perfect”, because there was no sin in Adam and Eve’s hearts that blocked it. And, it was “Wonderfulness,” because it was far better than ANYTHING we can imagine.

“Perfect Wonderfulness”-- knowing, loving, trusting and obeying God completely. And God sharing His love and showing Himself to Adam and Eve in a way that deeper and better than any of us has ever known. In the beginning, life with God was “Perfect Wonderfulness.” It could have stayed this way forever, but did it?



Perfect Wonderfulness

4. The best thing in that garden was the very special closeness Adam and Eve had with God. It was “Perfect Wonderfulness.” It was “Perfect”, because there was no sin in Adam and Eve’s hearts that blocked it. And, it was “Wonderfulness,” because it was far better than ANYTHING we can imagine. “Perfect Wonderfulness”-- knowing, loving, trusting and obeying God completely. And God sharing His love and showing Himself to Adam and Eve in a way that deeper and better than any of us has ever known. In the beginning, life with God was “perfect Wonderfulness.” It could have stayed this way forever, but did it?

5. No, the “Perfect Wonderfulness” did NOT last forever.

Satan, God's enemy, came into the Garden. He tempted Adam and Eve to doubt God and His goodness. His plan worked. Right there, in the middle of that beautiful garden of love, Adam and Eve stopped trusting God and chose to rebel against Him instead.



5. No, the “Perfect Wonderfulness” did NOT last forever. Satan, God’s enemy, came into the Garden. He tempted Adam and Eve to doubt God and His goodness. His plan worked. Right there, in the middle of that beautiful garden of love, Adam and Eve stopped trusting God and chose to rebel against Him instead.

6. What would God do? There was only one thing that He COULD do. You see, God is GOOD and HOLY. He hates sin. It is BAD. So, God did what He must: He punished Adam and Eve for their disobeying.

Life in God's perfect world was broken. Now, there would be sin, sadness, sickness, and death. Life in the Garden was broken, too. Adam and Eve lost their perfect food and jobs and friendship with each other.

Worst of all, they lost their Perfect Wonderfulness, their very special closeness with God that would've gone on forever. What a lot Adam and Eve lost that sad day!



6. What would God do? There was only one thing that He COULD do. You see, God is GOOD and HOLY. He hates sin. It is BAD. So, God did what He must: He punished Adam and Eve for their disobeying. Life in God's perfect world was broken. Now, there would be sin, sadness, sickness and death. Life in the Garden was broken, too. Adam and Eve lost their perfect food and jobs and friendship with each other. Worst of all, they lost their Perfect Wonderfulness, their very special closeness with God that would've gone on forever. What a lot Adam and Eve lost that sad day!

7. But there was something that Adam and Eve did NOT lose on that day. They did NOT lose God's love.

God, in His great love and mercy, was not finished with them or His world. He had always known what would happen. And He had always planned for it. He would NOT lose His people. He would SAVE them from their sins; and He, Himself, would do it.



7. But there was something that Adam and Eve did NOT lose on that day. They did NOT lose God's love. God, in His great love and mercy, was not finished with them or His world. He had always known what would happen. And He had always planned for it. He would NOT lose His people. He would SAVE them from their sins; and He, Himself, would do it.

8. So, on that very day, God gave Adam and Eve a promise. He would send a Savior to crush the enemy. He would win back the Perfect Wonderfulness for them. He would win back the Forever Life with Him that He had created them to enjoy.

Yes, He would win it all back, through the Savior He would send. We know His name, don't we? That Savior would be Jesus, God's own Son.

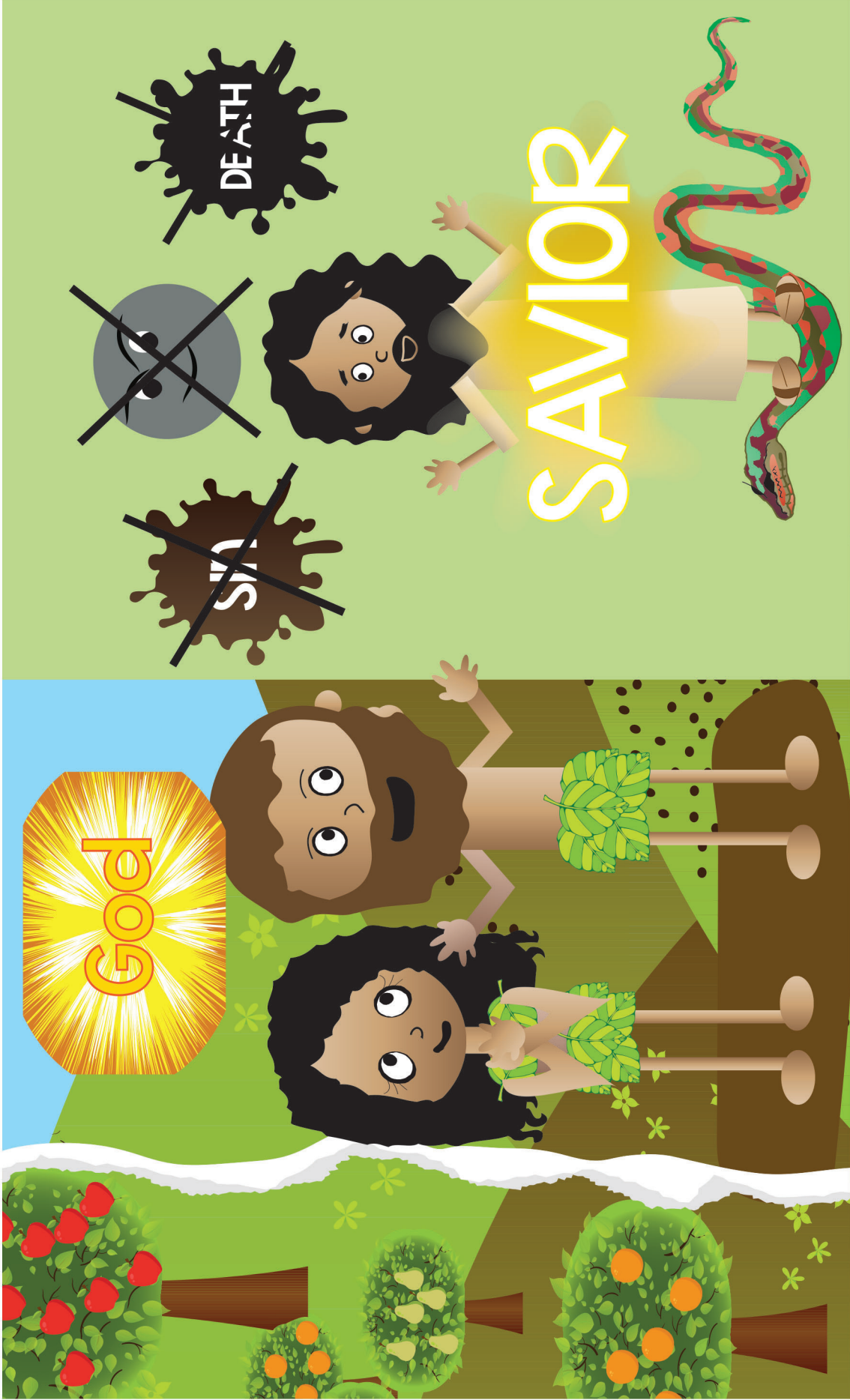

8. So, on that very day, God gave Adam and Eve a promise. He would send a Savior to crush the enemy. He would win back the Perfect Wonderfulness for them. He would win back the Forever Life with Him that He had created them to enjoy. Yes, He would win it all back, through the Savior He would send. We know His name, don't we? That Savior would be Jesus, God's own Son.

9. Adam and Eve had a family. Their children had children, too. They were just like Adam and Eve. They had two eyes, two ears, two legs, and two arms. One head with one nose and one mouth. They even had that special heart made to know and love God.

But sadly, their hearts were broken with sin, also just like Adam and Eve's. They ALL chose to disobey God and they ALL deserved His punishment. How sad!

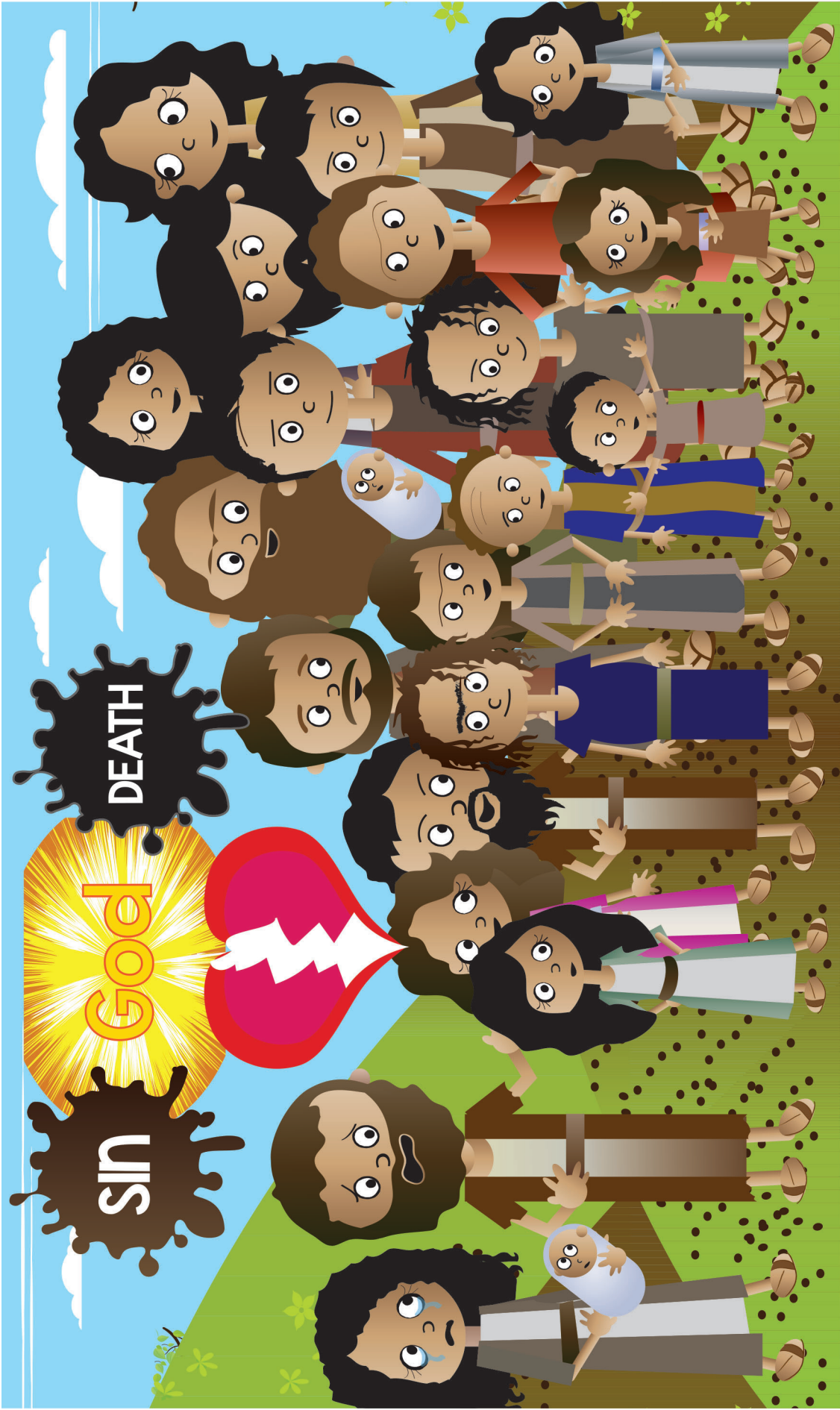

9. Adam and Eve had a family. Their children had children, too. They were just like Adam and Eve. They had two eyes, two ears, two legs, and two arms. One head with one nose and one mouth. They even had that special heart made to know and love God. But sadly, their hearts were broken with sin, also just like Adam and Eve's. They ALL chose to disobey God and they ALL deserved His punishment. How sad!

10. But there was good news, too.

Though they all disobeyed God and their hearts were broken with sin, some remembered God's promise to crush their enemy. They trusted in God and looked forward in faith to the day when the Savior would come--Jesus, God's own Son.



10. But there was good news, too. Though they all disobeyed God and their hearts were broken with sin, some remembered God's promise to crush their enemy. They trusted in God and looked forward in faith to the day when the Savior would come--Jesus, God's own Son.

II. God's plan to send the Savior began to unfold.

God chose Abraham and his family to be the ones to prepare the world for the Savior. God told Abraham that all people would be blessed through someone who would be born into his family one day. That someone would be the Savior, Jesus, God's own Son.

But first, God prepared Abraham's family to be ready for this Savior. He grew Abraham's family into a big nation. He rescued them from their enemies. He gave them His good laws to live by and a beautiful land to live in.



II. God's plan to send the Savior began to unfold. God chose Abraham and his family to be the ones to prepare the world for the Savior. God told Abraham that all people would be blessed through someone who would be born into his family one day. That someone would be the Savior, Jesus, God's own Son.

But first, God prepared Abraham's family to be ready for this Savior. He grew Abraham's family into a big nation. He rescued them from their enemies. He gave them His good laws to live by and a beautiful land to live in.

12. Life as God's special people in God's promised land could have always been wonderful. But, Abraham's family were sinners, like everyone else since Adam and Eve disobeyed God. Sometimes, they did obey God; and oh, how they enjoyed His great blessings when they did! But many times they worshipped fake gods. And then, they received God's loving discipline.

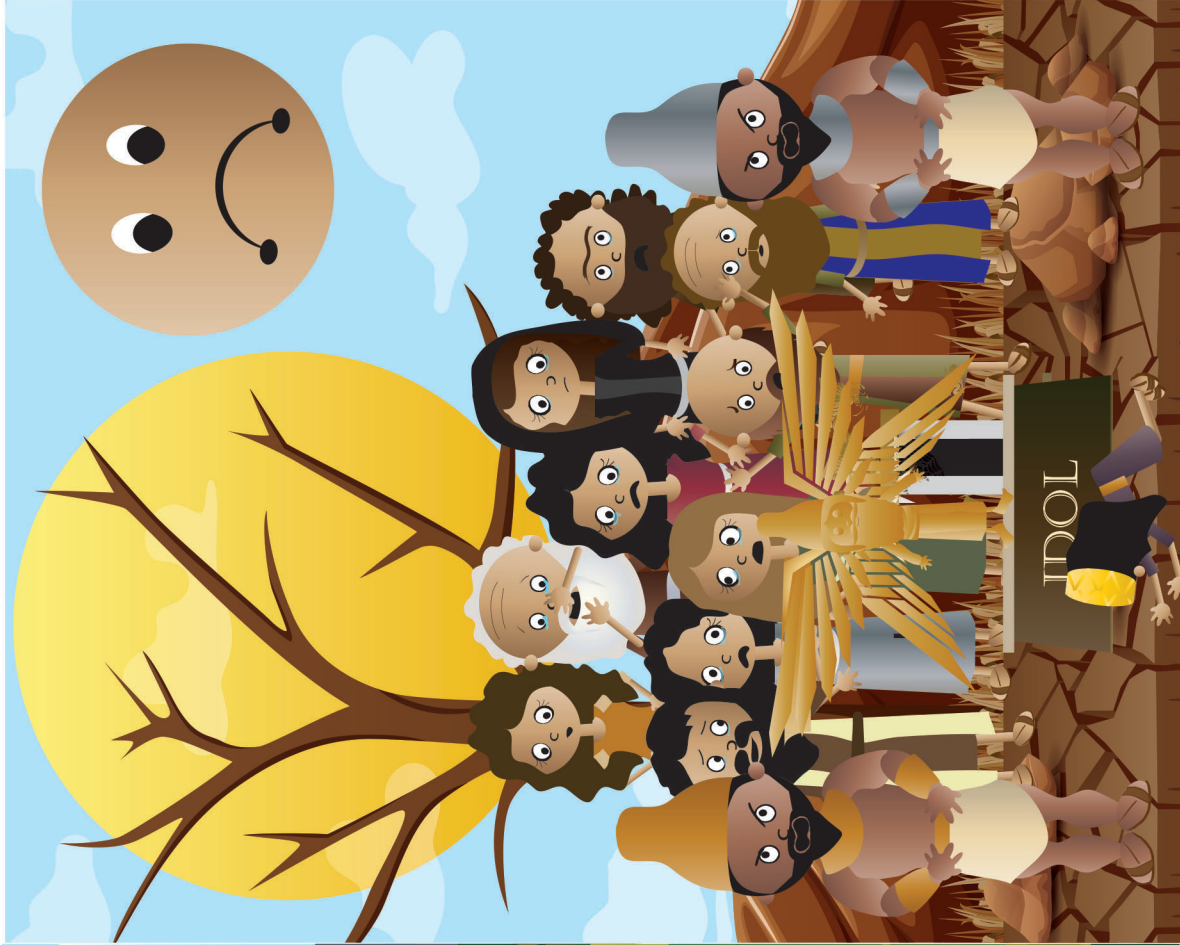
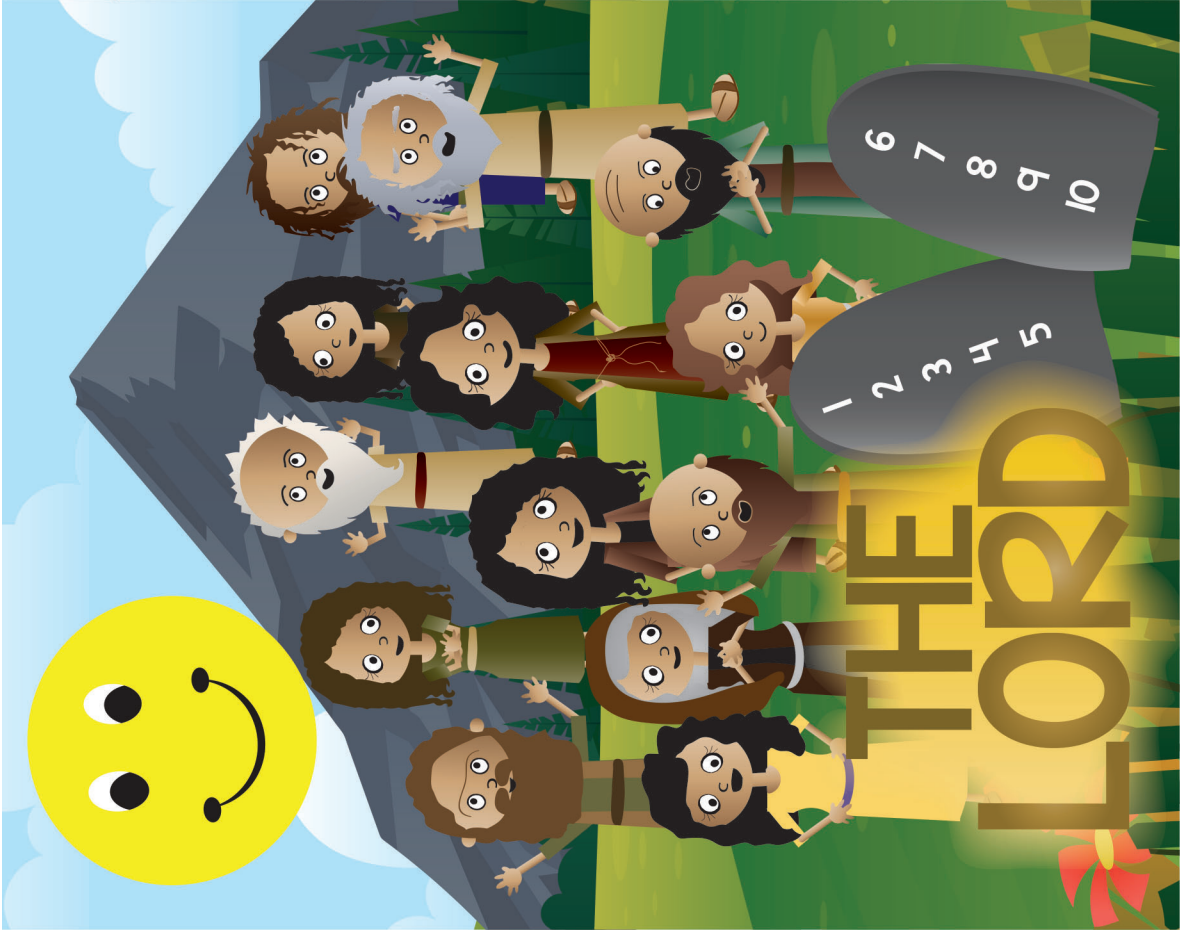

12. Life as God's special people in God's promised land could have always been wonderful. But, Abraham's family were sinners, like everyone else since Adam and Eve disobeyed God. Sometimes, they did obey God; and oh, how they enjoyed His great blessings when they did! But many times they worshipped fake gods. And then, they received God's loving discipline.

13. When they kept refusing to obey, God's discipline became more painful. How God loved His people! He sent them far away from their home to work for their enemies. They were so sad. They missed the good home and the good life He had given them.

At last, their hearts changed. They were sorry they had disobeyed God. They wanted to turn back to Him. God sent them good news: one day He would bring them back home. And one day, He would send a Savior. That Savior would be Jesus, God's own Son. Those were His promises.



13. When they kept refusing to obey, God's discipline became more painful. How God loved His people! He sent them far away from their home to work for their enemies. They were so sad. They missed the good home and the good life He had given them. At last, their hearts changed. They were sorry they had disobeyed God. They wanted to turn back to Him. God sent them good news: one day He would bring them back home. And one day, He would send a Savior. That Savior would be Jesus, God's own Son. Those were His promises.

14. God kept His promises. He brought Abraham's family back home. And then, at just the right time, God sent the Savior to be born in Bethlehem -- Jesus, God's own Son.



14. God kept His promises. He brought Abraham's family back home. And then, at just the right time, God sent the Savior to be born in Bethlehem--Jesus, God's own Son.

15. Jesus grew up. He taught about God and did many amazing things. He lived a perfect life-- the life that Adam and Eve and all of us were supposed to live, but never did. Jesus showed that He was God's Son, the Savior.

But Jesus didn't just come to SHOW us that He was the Savior. He came to BE the Savior. Jesus would make the way for us to have special closeness with God again. He would pay for our sins, so that through Him, we could enjoy Perfect Wonderfulness with God forever.

But, oh, what a terrible way it must all happen!



15. Jesus grew up. He taught about God and did many amazing things. He lived a perfect life-- the life that Adam and Eve and all of us were supposed to live, but never did. Jesus showed that He was God's Son, the Savior.

But Jesus didn't just come to **SHOW** us that He was the Savior. He came to **BE** the Savior. Jesus would make the way for us to have special closeness with God again. He would pay for our sins, so that through Him, we could enjoy Perfect Wonderfulness with God forever. But, oh, what a terrible way it must all happen!

16. Sin couldn't be paid for with money. Sin even couldn't be paid for by Jesus living a perfect life in our place.

No, sin could only be paid for by Jesus living a perfect life, and then Him GIVING IT UP for sinful people, like us. He took their punishment. He died the death that we deserved! That was the only way!

So, that's what Jesus did. He suffered and died on the cross as the perfect sacrifice for the sins of God's people.. He was their substitute. He was their payment!

God's Son, Jesus, the Savior



16. Sin couldn't be paid for with money. Sin even couldn't be paid for by Jesus living a perfect life in our place. No, sin could only be paid for by Jesus living a perfect life, and then Him GIVING IT UP for sinful people, like us. He took their punishment. He died the death that we deserved! That was the only way! So, that's what Jesus did. He suffered and died on the cross as the perfect sacrifice for the sins of God's people.. He was their substitute. He was their payment!

17. How Jesus hurt that day as He suffered and died for people like you and me! How much God loved us that He would pay for our sins, Himself, through His Son, Jesus!

As Jesus died on the cross, His last words were, "It is finished." But what was finished? Was it just His life that was finished? Or could He mean something more?



17. How Jesus hurt that day as He suffered and died for people like you and me! How much God loved us that He would pay for our sins, Himself, through His Son, Jesus! As Jesus died on the cross, His last words were, "It is finished." But what was finished? Was it just His life that was finished? Or could He mean something more?

18. Later that day, some men took Jesus' body to be buried in a cave grave in a garden. That looked like the end. But was it?



18. Later that day, some men took Jesus' body to be buried in a cave grave in a garden. That looked like the end. But was it?

19. On Day One and Two, Jesus' body stayed in that cave-grave.

But something amazing happened on Day Three. Jesus rose up from the dead in victory. He was alive! Jesus had really beaten sin and death!

That's what He had finished that day He suffered and died on the cross. All those sins were paid for. The way back to perfect Wonderfulness with God was made!

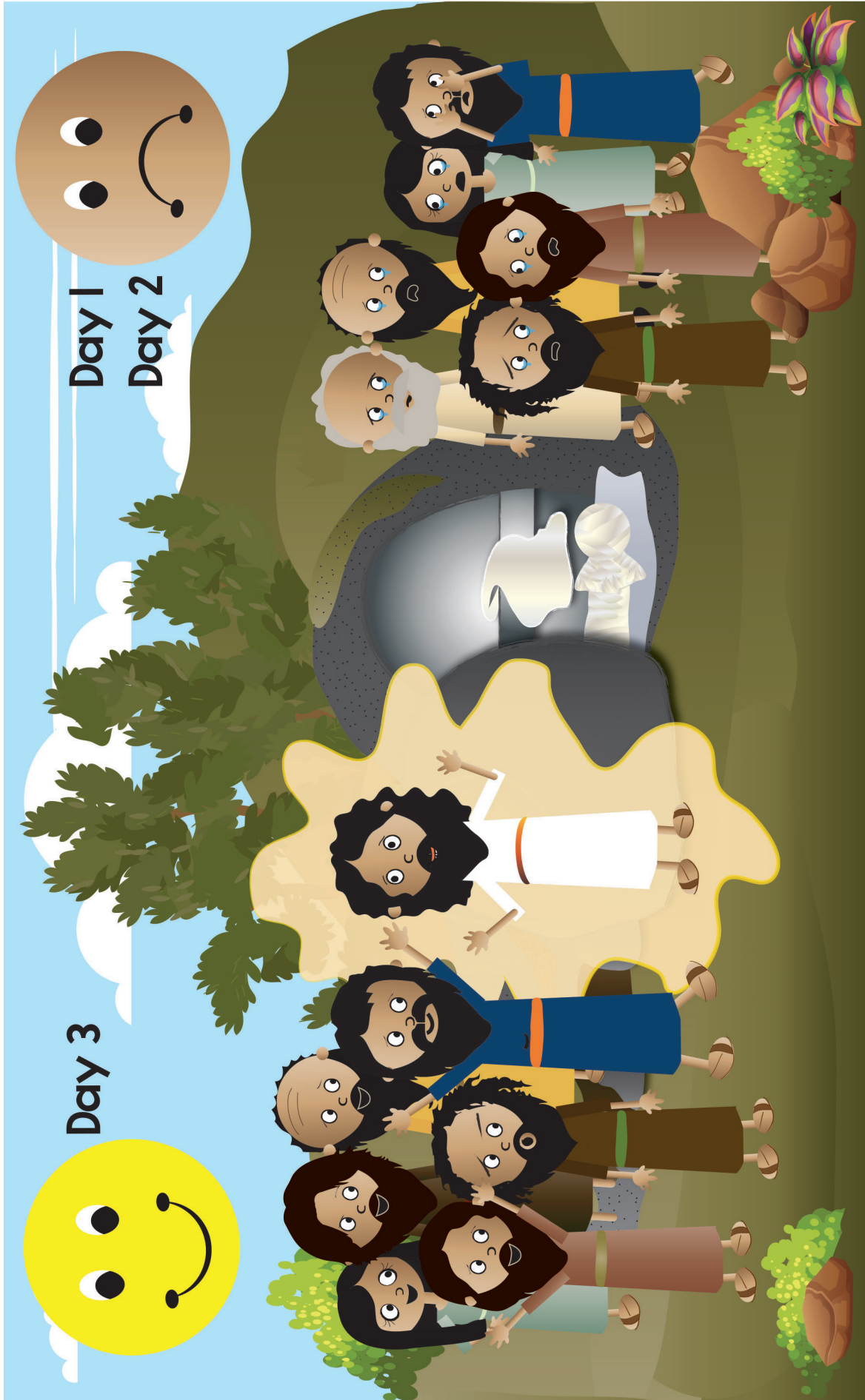

19. On Day One and Two, Jesus' body stayed in that cave-grave. But something amazing happened on Day Three. Jesus rose up from the dead in victory. He was alive! Jesus had really beaten sin and death! That's what He had finished that day He suffered and died on the cross. All those sins were paid for. The way back to Perfect Wonderfulness with God was made!

20. Now, all who turn away from their sins and trust in Jesus as their Savior can become God's people. God has forgiven their sins through Jesus.

Right here on earth, they get to enjoy a bit of special closeness with God, through God's Holy Spirit living in their hearts. And one day, when they die, they will go to enjoy full, Perfect Wonderfulness with God forever.

Perfect Wonderfulness. Perfect Forever. All of that can be ours, because Jesus, the Savior, came. Thank You, Jesus!

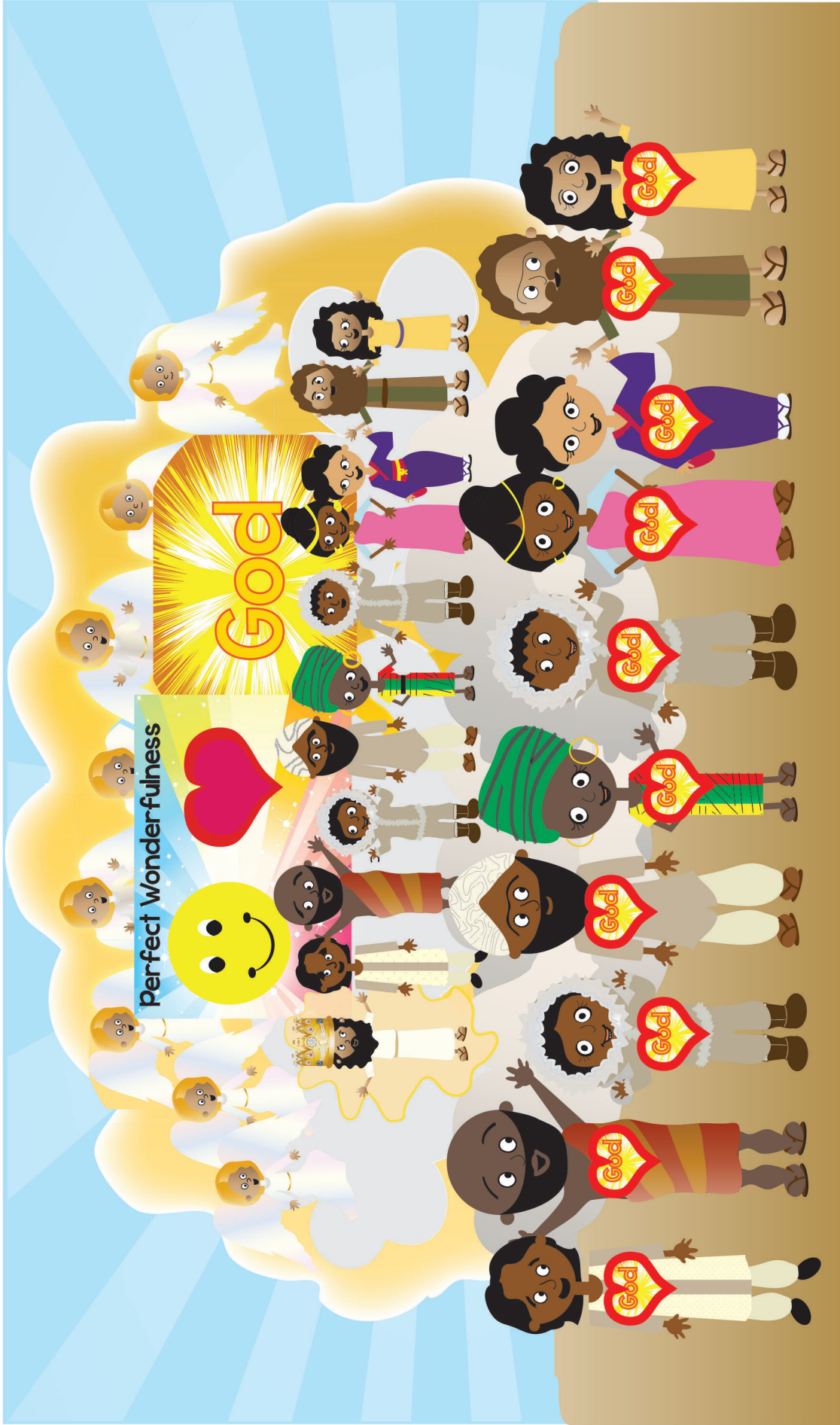

20. Now, all who turn away from their sins and trust in Jesus as their Savior can become God's people. God has forgiven their sins through Jesus. Right here on earth, they get to enjoy a bit of special closeness with God, through God's Holy Spirit living in their hearts. And one day, when they die, they will go to enjoy full, Perfect Wonderfulness with God forever. Perfect Wonderfulness. Perfect Forever. All of that can be ours, because Jesus, the Savior, came. Thank You, Jesus!

DDD 3:3

The Case of the Savior, from Start to Finish Genesis, The Gospels

SOLVED

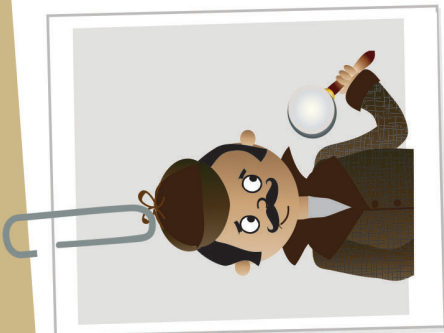

Detective Dan's Listening Assignment #1

1. Who was the Savior?
God's Son, Jesus.

2. When did the promise of a Savior start? When did it finish?
It started back in the beginning when Adam and Eve disobeyed God. It finished when Jesus died on the cross for the sins of God's people and rose from the dead in victory.

For You and Me:
The promise of the Savior wasn't just for Adam and Eve or all those people who lived long ago. It is for us, too. It is for all who turn away from their sins and trust in Jesus as their Savior. He came to give us special closeness with God. He came so we could know the Perfect Wonderfulness of life with God. Thank You, Jesus!



Detective Dan's Listening Assignment #2

Isaiah 53:5, ESV

"He was pierced for our transgressions, he was crushed for our iniquities; the punishment that brought us peace was upon him."

Transgressions and iniquities are other words for sin.

1. Whose transgressions and iniquities deserved God's punishment in our story?
All people.

2. Who came to take God's punishment for them?
Jesus, God's Son.

For You and Me:

The promise of the Savior wasn't just for Adam and Eve or all those people who lived long ago. It is for us, too. It is for all who turn away from their sins and trust in Jesus as their Savior. He came to give us special closeness with God. He came so we could know the Perfect Wonderfulness of life with God. He did this by paying for our sins, Himself! Thank You, Jesus!

DDD 3:3

What is the Gospel?

It is Salvation through Faith in Jesus Christ...

God sent Jesus to pay for the sins of God's people!

The Gospel



How merciful is God! How great is His love for sinners, like you and me! Though we have all chosen to disobey Him, He always planned to provide us with a Savior!

That Savior would be Jesus, God's own, dear Son! Jesus chose to suffer and die on the cross and give up His perfect life as the full payment for sin that we needed. On the third day, Jesus rose up from the dead in victory! He had beaten sin and death for God's people completely!

How can Jesus be our Savior? How can we become God's people? By turning away from our sins and trusting in Him as our Savior. Ask Him to help you! He loves to answer this prayer!

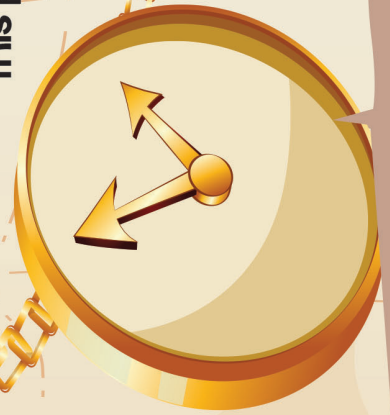

DDD 3:3

A Prayer

A God, we praise You for being the good Creator and King of the world.

C God, we confess rebelling against You and Your good ways. Too many times we choose to live life our own way instead of Yours. We need a Savior!

T Thank You for being our good Creator and King. Thank You for making everything in the world for Your good purposes. Thank You for being so merciful to us! Thank You for offering us salvation through Jesus, when we repent of our sins and trust Him as our Savior.

S God, work in our hearts. Help us to turn away from disobeying You. Help us to trust in Jesus as our Savior. Help us to obey Your good ways and bring You glory.

In Jesus' name we pray. Amen.



DDD 3:3

DEEP DOWN DETECTIVES



Unit 3,

Bible Truth 4

Story Scene Pictures

Using Simple Story Scenes as a Curriculum

Introduce the Key Concept and Bible Verse

Simple Story Scenes give you the basics for the core of your lesson. You can use the overview sheet to introduce and explain the key concept and Bible verse.

Give the Case Assignment

Give the children a Detective Dan listening assignment. Two are provided. You can add a third using the ideas on the bonus, third take-home sheet, if desired. Each listening assignment, let's you teach the story with a different learning emphasis.

Show & Tell the Story

Hold up the pictures and tell the story from the story scenes. Alternatively, you can find in the and Pieces section for this unit at praisefactory.org, these same listening assignments and story scenes, gospel and ACTS prayer modified for view on a screen. Simply download them or open them online and show through your own monitor (tablet, big screen, whatever).

Solve the Case

Repeat Detective Dan's listening assignment question and discuss the answer.

Share the Gospel

Share the gospel tie-in with the kids.

Close in ACTS Prayer

Pray the ACTS prayer with the kids. If using the curriculum with older children, give them a chance to think up their own ACTS tie-ins to the story, using the one provided as cues/ideas for you.

Review Time

Give out the take-home sheet (there are three: two that correlates to the two Detective Dan assignments in the Story Scenes, and a bonus third one.) As the children are coloring, use the take-home sheet discussion questions or your own questions to further review and apply the key concepts, Bible verse, and story truths to the children.

Looking for more?

Online, in the Bits and Pieces section for this unit, you will find review games, crafts, storyboard flannelgraph figures, and audio and sheet music for all of the songs. There are also full lesson plans that offer more of a script and take this curriculum's possibilities to much more depth. Don't forget to tell the parents about the Parents Resources section where they can read through the Story scenes and download take homes with their kids.

Unit 3: The Good News of God, the Gospel

Unit Big Question (and Answer): What Is the Gospel? It's Salvation through Faith in Jesus Christ!

Unit Bible Verse: "For God so loved the world, that he gave his only Son, that whoever believes in him should not perish but have eternal life." John 3:16, ESV

Bible Truth 4 Concept: Salvation through Faith in Jesus Christ...God Saves All Who Repent of Their Sins and Trust in Jesus as Their Savior!

God is our good Creator and King. He made us to know Him, love Him and obey His good laws. But sadly, we all have chosen to disobey God and His good laws. We deserve His punishment for our sins. We have all turned away from Him.

But God has made a way for us to be forgiven our sins and to become His people. In His great love and mercy, God sent His Son, Jesus, to be our Savior. Jesus lived a perfect life. He never disobeyed God. He offered up His life as the full payment for sin when He suffered and died on the cross. On the third day, He rose from the dead. Jesus had done it! He had beaten sin and death for God's people!

How can we become one of God's people? Who can receive God's gift of forgiveness? All who repent of their sins and trust in Jesus as their Savior. Repent means to stop living a life full of disobeying God and to start living to please God, instead. God can help us repent and believe. Ask Him!

How wonderful it is to be one of God's people! To have special closeness with God by His Holy Spirit living in your heart now. And one day, to go live with God forever. That will be best of all!

Bible Truth 4 Bible Verse: Mark 1:15, ESV

"The time is fulfilled, and the kingdom of God is at hand; repent and believe in the gospel!"

Learn a Little: "Repent and believe in the gospel!"

Meaning

For years and years, God had promised to send a Savior to save us from our sins. For years and years, people waited and watched...and they watched and waited. At last, Jesus came! He taught the people about God and did amazing things. He showed them that He was God's Son, the Savior God had promised.

But what did people have to do, if they were to be forgiven by God for their sins? Jesus told them: "Repent and believe in the gospel--the good news that Jesus was God's Son, the Savior, sent to save them. We can be forgiven, too, when we repent (that is, turning away disobeying God and turning to live for God, instead) and believe that Jesus is God's Son, the Savior. God loves to help us do this. Ask Him!"

Bible Truth 4 ACTS Prayer

- A** God, we praise You for being so full of love and mercy! You call us to repent and believe in Jesus that we might be saved.
- C** We confess that we often disobey You and Your good ways. We choose to live life our own way, not Yours. We need a Savior!
- T** Thank You, God, for offering us salvation through Jesus, when we repent of our sins and trust in Jesus as our Savior.
- S** God, work in our hearts. Help us to trust in Jesus as our Savior. Help us to joyfully obey You. You know what is best for us and what brings You glory. In Jesus' name we pray. Amen.

Bible Truth 4 Story**The Case of the Changes in Cruddy Crete***Titus*

Songs Used in Bible Truth 4

Big Question 3 Bible Verse Song: For God So Loved the World John 3:16 ESV

Extra Big Question 3 Bible Verse Song: For God So Loved the World John 3:16 ESV (version 2)

Extra Big Question 3 Bible Verse Song: For God So Loved the World John 3:16 ESV (version 3)

Big Question 3 Hymn: And Can It Be, v.1 Refrain

Big Question 3 Praise Song: I Have Decided to Follow Jesus

Bible Truth 4 Bible Verse Song: The Time Is Fulfilled Mark 1:15, ESV

Bible Truth 4 Extra Bible Verse Song: The Time Mark 1:15, ESV (other version)

Bible Truth 4 Extra Bible Verse Song: Everyone Who Names the Name 2 Timothy 2:19,22, ESV

Bible Truth 4 Extra Bible Verse Song: Help Us, O God of Our Salvation Psalm 79:9, ESV

listen to or download songs for free at <https://praisefactory.org>: Deep Down Detectives Music page

The Case of the Changes in Cruddy Crete Titus



Detective Dan's Listening Assignment #1

1. What was Crete and what was so cruddy about it?
2. Who changed in Crete? How did they change?



Detective Dan's Listening Assignment #2

Mark 1:15, ESV

"Repent and believe in the gospel."

1. Who went to Crete to tell the people to repent and believe?
2. What was the gospel that he wanted them to repent and believe in?

(more listening and discussion questions are included in the curriculum at praisefactory.org)

1. This story is an island story. Do you know what an island is?

It's a little piece of land stuck out in the middle of a big piece of water, such as a sea or an ocean. The island in this story was very famous for something. Let's think what it might be...



I. This story is an island story. Do you know what an island is? It's a little piece of land stuck out in the middle of a big piece of water, such as a sea or an ocean. The island in this story was very famous for something. Let's think what it might be...

2. Some islands are famous for their tall, volcano mountains that spray out smoke and hot lava. THIS island had tall, volcano mountains with smoke and lava... but that's not what it was famous for.

Other islands are famous for their beautiful, sandy beaches, with palm trees blowing in the breeze, and colorful fish swimming in the clear, blue water. THIS island had beautiful beaches with swaying palm trees. It had colorful fish swimming in the clear water... but that's not what it was famous for.



2. Some islands are famous for their tall, volcano mountains that spray out smoke and hot lava. THIS island had tall, volcano mountains with smoke and lava... but that's not what it was famous for. Other islands are famous for their beautiful, sandy beaches, with palm trees blowing in the breeze, and colorful fish swimming in the clear, blue water. THIS island had beautiful beaches with swaying palm trees. It had colorful fish swimming in the clear water... but that's not what it was famous for.

3. Some islands are even famous for their tasty, island food and their good, island people. Ah... and NOW we're getting very close to what THIS island was famous for.

Because, while this island DID have tasty, island food that was yummy in your tummy, it was famous for NOT having that other thing-- good, island people!



3. Some islands are even famous for their tasty, island food and their good, island people. Ah... and NOW we're getting very close to what THIS island was famous for. Because, while this island DID have tasty, island food that was yummy in your tummy, it was famous for NOT having that other thing-- good, island people!

4. Yes, THIS island was famous for its BAD, island people. And that's why, though the name of this island was really just "Crete," most people thought of it more like "Cruddy Crete." (Cruddy is a word that means something is no good.)

This island was filled with many bad people doing many bad things. There were liars and cheaters and lazy over-eaters, just to name a few. And that's why "Cruddy Crete" was really a very good nickname for the island of Crete.

Liars Cheaters

Lazy Over-eaters



4. Yes, THIS island was famous for its BAD, island people. And that's why, though the name of this island was really just "Crete," most people thought of it more like "Cruddy Crete." (Cruddy is a word that means something is no good.) This island was filled with many bad people doing many bad things. There were liars and cheaters and lazy over-eaters, just to name a few. And that's why "Cruddy Crete" was really a very good nickname for the island of Crete.

5. Many people stayed away from Cruddy Crete. After all, why would anyone want to go to a place like this with all these bad people doing all of these bad things? Surely, there were other islands with beaches and fish and volcanoes and tasty food that had GOOD island people! So why go to one with such BAD people on it?



5. Many people stayed away from Cruddy Crete. After all, why would anyone want to go to a place like this with all these bad people doing all of these bad things? Surely, there were other islands with beaches and fish and volcanoes and tasty food that had GOOD island people! So why go to one with such BAD people on it?

6. Cruddy Create certainly doesn't sound like a nice place to visit; but, our story is about two men --Paul and Titus-- who very much wanted to go there. And as crazy as it sounds, they wanted to go there for the very reason that you and I might NOT want to go: to be with all of those bad people!

Paul and Titus wanted to tell them the gospel. The good news that Jesus, the Savior, had come and could save them from their sins. Yes, even these people could become God's people!



6. Cruddy Crete certainly doesn't sound like a nice place to visit; but, our story is about two men --Paul and Titus-- who very much wanted to go there. And as crazy as it sounds, they wanted to go there for the very reason that you and I might NOT want to go: to be with all of those bad people! Paul and Titus wanted to tell them the gospel. The good news that Jesus, the Savior, had come and could save them from their sins. Yes, even these people could become God's people!

7. You see, sinners --people who disobey God and His good ways-- were exactly the kind of people Jesus had come to save. And Jesus was such a great Savior, that there were no people too cruddy and no hearts too full of sin that Jesus could not save them.

Jesus could save even the WORST of sinners --even people as bad as those on Cruddy Crete.

God's Son, Jesus, the Savior



7. You see, sinners --people who disobey God and His good ways-- were exactly the kind of people Jesus had come to save. And Jesus was such a great Savior, that there were no people too cruddy and no hearts too full of sin that Jesus could not save them. Jesus could save even the WORST of sinners --even people as bad as those on Cruddy Crete.

7. You see, sinners --people who disobey God and His good ways-- were exactly the kind of people Jesus had come to save. And Jesus was such a great Savior, that there were no people too cruddy and no hearts too full of sin that Jesus could not save them.

Jesus could save even the WORST of sinners --even people as bad as those on Cruddy Crete.

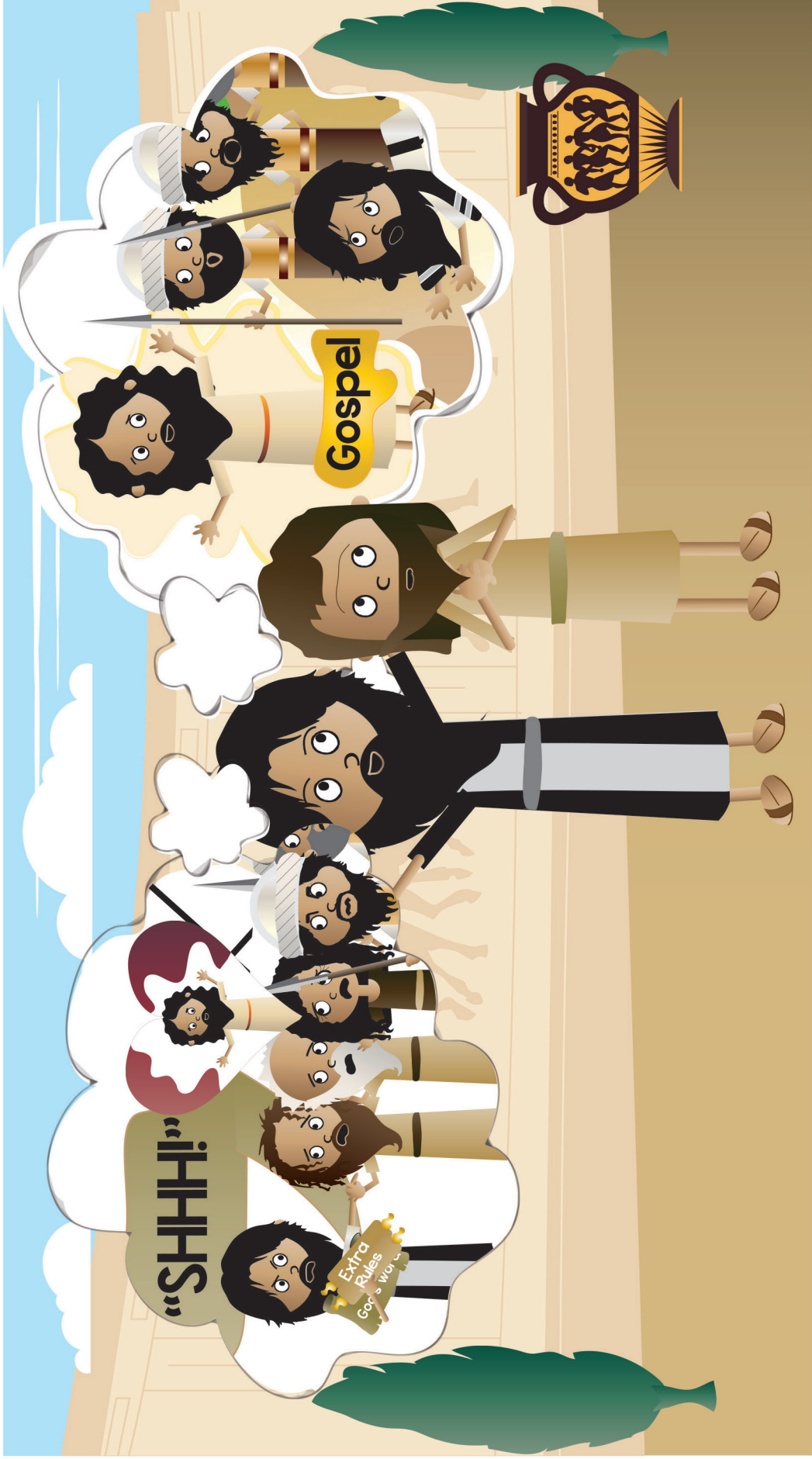

8. Perhaps that's why Paul wanted to go to Crete so very much. Paul had once been a bad sinner like them. He had hated Jesus and done many bad things to hurt Jesus' followers. Paul deserved God's punishment for all the bad things he had done; but, God chose to forgive Paul's sins through Jesus, instead. Paul trusted in Jesus as his Savior and repented of his sins. God saved Paul and changed him. Paul was so grateful to God for forgiving his sins! And if there was one thing Paul loved to tell others, it was how God could save and change them, too.

9. So, off Paul went with his young friend, Titus. They headed by boat to Cruddy Crete to tell the people the good news of the gospel.

Paul and Titus sailed over the wavy seas for many days. Then, at last, there was Crete!

Paul and Titus saw the volcano mountains, the sandy beaches, and the colorful fishes. They saw the swaying palm trees and tasted the good, island food. Then, they met the island people. The people were cruddy, all right! Liars and cheaters and lazy over-eaters, just to name a few. How they all needed to know about the Savior, Jesus!



9. So, off Paul went with his young friend, Titus. They headed by boat to Cruddy Crete to tell the people the good news of the gospel. Paul and Titus sailed over the wavy seas for many days. Then, at last, there was Crete! Paul and Titus saw the volcano mountains, the sandy beaches, and the colorful fishes. They saw the swaying palm trees and tasted the good, island food. Then, they met the island people. The people were cruddy, all right! Liars and cheaters and lazy over-eaters, just to name a few. How they all needed to know about the Savior, Jesus!

10. Paul and Titus went right to work. They walked from town to town, sharing the good news of Jesus everywhere they went --with the liars, the cheaters, the lazy over-eaters, and anyone else who would listen.

This is the good news of the gospel they shared: "God is the good King and Creator of the world. He made us and gave us His good laws to live by. But we have all chosen to disobey God and we deserve His punishment! We need a Savior to save us from our sins. God, Himself, provided that Savior --His very, own Son, Jesus.

Liar



10. Paul and Titus went right to work. They walked from town to town, sharing the good news of Jesus everywhere they went --with the liars, the cheaters, the lazy over-eaters, and anyone else who would listen. This is the good news of the gospel they shared: "God is the good King and Creator of the world. He made us and gave us His good laws to live by. But we have all chosen to disobey God and we deserve His punishment! We need a Savior to save us from our sins. God, Himself, provided that Savior --His very, own Son, Jesus.

II. “Jesus came to earth. He lived a perfect life, then on the cross He suffered and died as the perfect sacrifice for the sins of God’s people,” Paul told them. “Then Jesus rose up from the dead on the third day in victory.”

Cheaters



II. "Jesus came to earth. He lived a perfect life, then on the cross He suffered and died as the perfect sacrifice for the sins of God's people," Paul told them. "Then Jesus rose up from the dead on the third day in victory."

12. “Now, all who turn away from their sins and trust in Jesus as their Savior will be saved! They become God’s special people who know Him in their hearts now, and will go live with Him forever,” Paul explained. “Come, repent; come, believe in Jesus! Come, be saved from your sins!” Paul urged the people of Cruddy Crete.

What would happen? Would they believe? Would they repent?

Lazy Over-eaters



12. "Now, all who turn away from their sins and trust in Jesus as their Savior will be saved! They become God's special people who know Him in their hearts now, and will go live with Him forever," Paul explained. "Come, repent; come, believe in Jesus! Come, be saved from your sins!" Paul urged the people of Cruddy Crete. What would happen? Would they believe? Would they repent?

13. God worked in the hearts of the liars, and the cheaters, and the lazy over-eaters as they listened to Paul preach. They could see that they were sinners. They could see that they needed a Savior. They wanted God's forgiveness through Jesus.

But what ELSE had Paul told these people they needed to do to be saved? It wasn't only BELIEVE. There was something else they needed to do. Can you remember what it was?



Liars

Cheaters

Lazy Over-eaters

13. God worked in the hearts of the liars, and the cheaters, and the lazy over-eaters as they listened to Paul preach. They could see that they were sinners. They could see that they needed a Savior. They wanted God's forgiveness through Jesus.

But what ELSE had Paul told these people they needed to do to be saved? It wasn't only BELIEVE. There was something else they needed to do. Can you remember what it was?

14. They needed to REPENT and believe.

Now THAT might be trouble for the people of Cruddy Crete. To become God's people, they would have to change the way they were living. No, they didn't have to be perfect and never sin again. Only Jesus could live a perfect life.

But, it DID mean that they would need to turn away from lying, cheating, and lazy over-eating as their WAY of life. They would need to choose to live for God, instead.

WOULD the people of Cruddy Crete do this? COULD they do this? They had been such bad people, living their own way for so long!

Liar

~~I didn't do it!~~

Cheaters

~~Pay me for that!~~

Lazy Over-eaters

~~More, more, more!~~

14. They needed to **REPENT** and believe. Now **THAT** might be trouble for the people of Cruddy Crete. To become God's people, they would have to change the way they were living. No, they didn't have to be perfect and never sin again. Only Jesus could live a perfect life. But, it **DID** mean that they would need to turn away from lying, cheating, and lazy over-eating as their **WAY** of life. They would need to choose to live for God, instead. **WOULD** the people of Cruddy Crete do this? **COULD** they do this? They had been such bad people, living their own way for so long!

15. Yes, they COULD; and yes, they WOULD! How? God would help them. He would work in their hearts.

He would help those liars turn from their lying, and those cheaters to turn from their cheating, and those lazy over-eaters to turn away from their lazy over-eating! And, He would keep on helping them the REST of their lives.

So right then and there, many people in Cruddy Crete repented of their sins and trusted in Jesus as their Savior. And before long, there were little groups of believers in every town on the island. How happy that made Paul and Titus!

Liars



Cheaters



Lazy Over-eaters

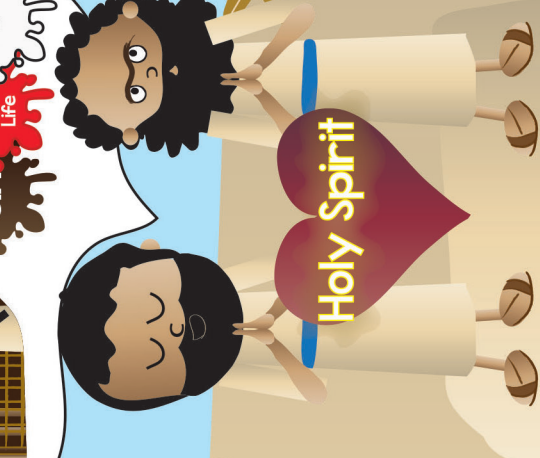

15. Yes, they **COULD**; and yes, they **WOULD**! How? God would help them. He would work in their hearts. He would help those liars turn from their lying, and those cheaters to turn from their cheating, and those lazy over-eaters to turn away from their lazy over-eating! And, He would keep on helping them the **REST** of their lives. So right then and there, many people in Cruddy Crete repented of their sins and trusted in Jesus as their Savior. And before long, there were little groups of believers in every town on the island. How happy that made Paul and Titus!

16. Paul soon set sail to share the good news of Jesus with other people. Titus stayed on Crete as pastor of these new believers.

Titus loved them, and prayed for them, and taught them the Bible. What a lot of help these people needed! After all, this was still Cruddy Crete. Many other island people STILL were liars, cheaters and lazy, over-eaters! It would be easy for those old sins to creep back into their lives. It was hard for those new believers to keep on loving God and living for Him.

Oh, how they wanted to love God and live for Him; but oh, how they struggled!



16. Paul soon set sail to share the good news of Jesus with other people. Titus stayed on Crete as pastor of these new believers. Titus loved them, and prayed for them, and taught them the Bible. What a lot of help these people needed! After all, this was still Cruddy Crete. Many other island people **STILL** were liars, cheaters and lazy, over-eaters! It would be easy for those old sins to creep back into their lives. It was hard for those new believers to keep on loving God and living for Him. Oh, how they wanted to love God and live for Him; but oh, how they struggled!

17. Far away in Corinth, Paul heard about their struggles. He wrote a letter to encourage them. Zenas and Apollos sailed over the wavy seas to Crete and gave it to Titus.



17. Far away in Corinth, Paul heard about their struggles. He wrote a letter to encourage them. Zenas and Apollos sailed over the wavy seas to Crete and gave it to Titus.

18. “Dear Titus,

Remind the new believers to keep on trusting in Jesus and keep on turning away from their sins. That’s the gospel.

Urge them to use their lives to do good to each other, to love God, and to hold onto God’s Word, the Bible. Remind them that they don’t have to do this on their own. The God who helped them repent and believe in Him at the beginning, promises to always be with them.

He will help them keep on believing in and living for Him every day. Say hello to everyone for me. And may God help you live for Him! Paul”

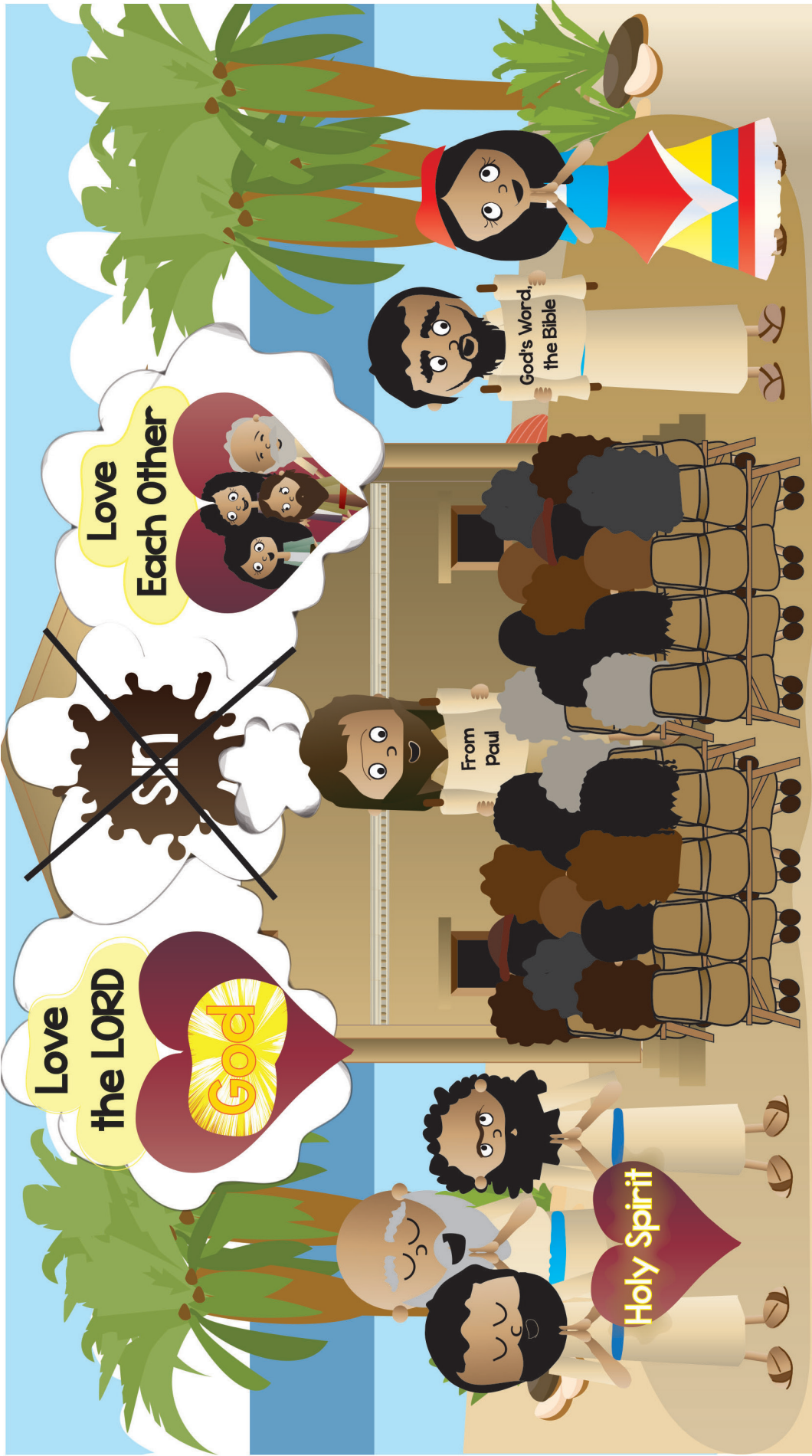

18. “Dear Titus, Remind the new believers to keep on trusting in Jesus and keep on turning away from their sins. That’s the gospel. Urge them to use their lives to do good to each other, to love God, and to hold onto God’s Word, the Bible. Remind them that they don’t have to do this on their own. The God who helped them repent and believe in Him at the beginning, promises to always be with them. He will help them keep on believing in and living for Him every day. Say hello to everyone for me. And may God help you live for Him! Paul.”

DDD 3.4

God Is Faithful to Help His People



19. What happened on Cruddy Crete after Titus read Paul's letter and shared it with the believers? Did the new believers keep on repenting of their sins, as well as believing in Jesus? The Bible doesn't tell us. It would have been hard to do on Cruddy Crete, but not impossible. Why? Because God doesn't just help people repent and believe in Jesus at the beginning. He promises to keep helping them to believe in Him and live for Him their whole lives—even in a place like Cruddy Crete, where wicked ways were right at home.

DDD 3.4

The Case of the Changes in Cruddy Crete Titus

SOLVED

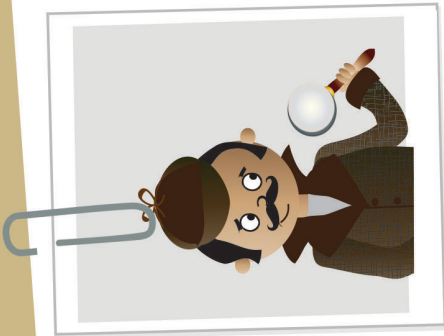

Detective Dan's Listening Assignment #1

1. What was Crete and what was so cruddy about it? Crete was an island. It was filled with people who rebelled against God and His good ways. They are what made the island so cruddy.
2. Who changed in Crete? How did they change? Many people changed in Crete when they heard the good news of Jesus. God's Holy Spirit worked in their hearts and helped them to repent of their sins and trust in Jesus as their Savior.

For You and Me:
Maybe we don't live in Cruddy Crete, but we need Jesus to be our Savior, just as much as they did. God can help us repent of our sins and trust in Jesus as our Savior, just like He helped them! Ask Him to help you!



Detective Dan's Listening Assignment #2

Mark 1:5, ESV

"Repent and believe in the gospel."

1. Who went to Crete to tell the people to repent and believe? Paul with his young friend, Titus.
2. What was the gospel that he wanted them to repent and believe in?
The good news that we can be forgiven our sins and become God's people through Jesus. Paul wanted the people of Crete to repent of their sins and trust in Jesus as their Savior. He wanted them to become God's people, too.

For You and Me:

The gospel Paul shared with the people of Crete is for us, too. God offers to forgive our sins and make us His people when repent of our sins and trust in Jesus as our Savior. Ask Him to help you! He loves to do this!

DDD 3.4

What is the Gospel?

It is Salvation through Faith in Jesus Christ...

God saves all who repent of their sins and trust in Jesus as their Savior!

The Gospel



Like the people in Cruddy Crete, we have all chosen to disobey God and to live our own way. Like them, we deserve God's punishment for rebelling against Him.

What good news is it to hear that God sent Jesus to be our Savior, too! Jesus died on the cross as the perfect payment for sins. On the third day, He rose from the dead, proving He had really beaten sin and death for God's people!

How can we become God's people? How can Jesus be our Savior? When we turn away from our sins and trust in Him as our Savior. God helped many people in Crete do this. He can help you, too. Ask Him! He loves to answer this prayer.



DDD 3.4

A Prayer

A God, we praise You for being so full of love and mercy! You call us to repent and believe in Jesus that we might be saved.

C We confess that we often disobey You and Your good ways. We choose to live life our own way, not Yours. We need a Savior!

T Thank You, God, for offering us salvation through Jesus, when we repent of our sins and trust in Jesus as our Savior.

S God, work in our hearts. Help us to trust in Jesus as our Savior. Help us to joyfully obey You. You know what is best for us and what brings You glory.

In Jesus' name we pray. Amen.



DDD 3.4

DEEP DOWN DETECTIVES



Take-Home Sheets

CAN YOU GUESS BIBLE TRUTH!:

What's the Gospel?

**It's Salvation through Faith
in Jesus Christ...**

**God made us
and we should**

Him!

**HINT: To do what someone
tells you to do. Rhymes with
the word "today."**

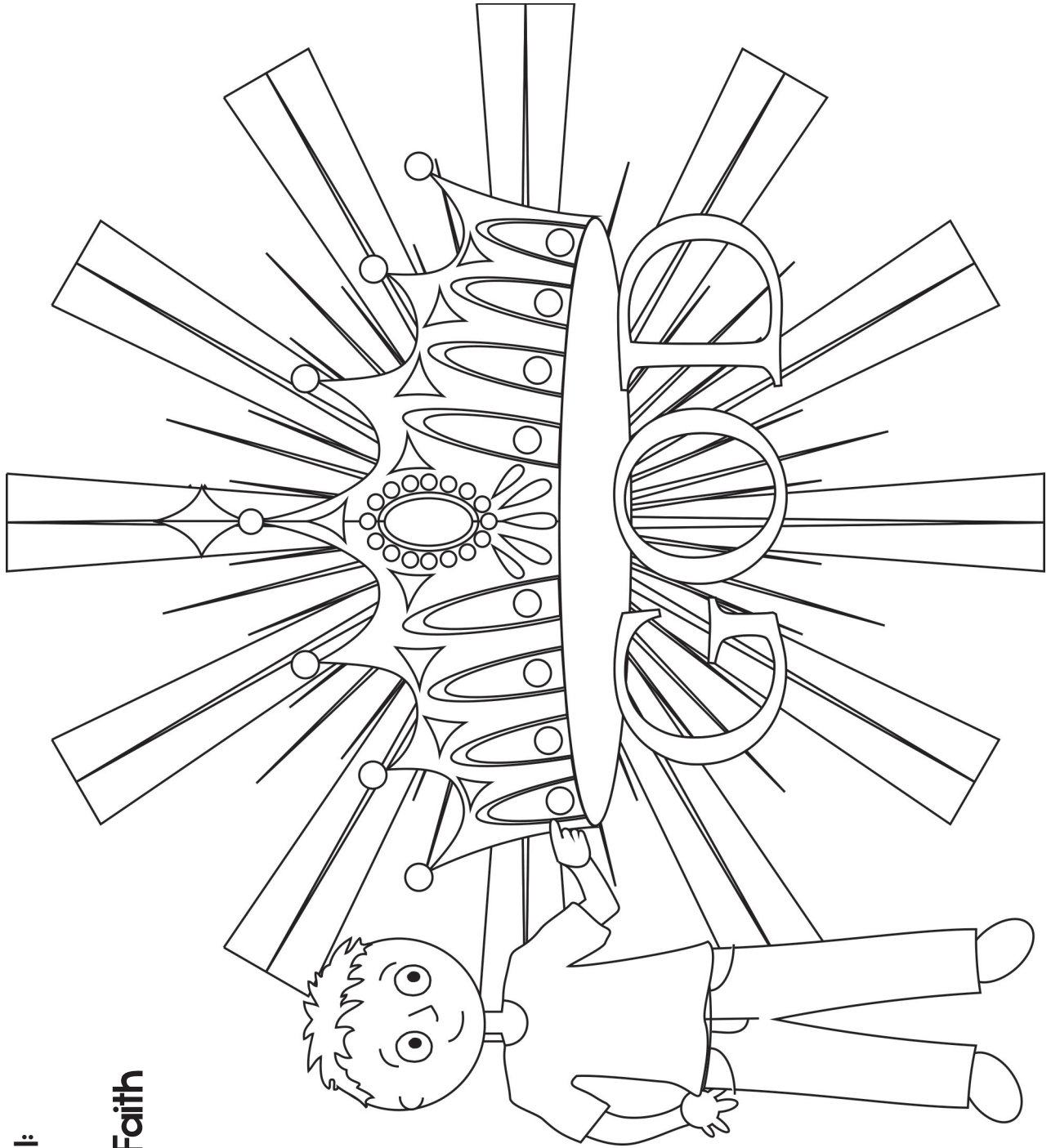

Deep Down Detective Devotion: Unit 3, Bible Truth 1, Lesson 1



Big Question 3: What Is the Gospel?

Answer: It's Salvation through Faith in Jesus Christ...God made us and we should obey Him!

Bible Truth 1 Meaning

Who made the world and everything in it? God did! And when God created the world, He made it perfect. Everything He made was good. There was no sin in it. It was all just exactly as He planned. God isn't just our Creator. He is our King. He rules over everything He made. He takes care of us and keeps the world going. He gives us good laws to live by, and consequences if we disobey Him. God rules over the world in perfect wisdom and goodness. He always knows what is best for us. We should worship, love, and obey Him.

How do I know this is true? The Bible tells me so!

"Make a joyful noise to the LORD, all the earth! Serve the LORD with gladness! Come into his presence with singing! Know that the LORD, he is God! It is he who made us, and we are his; we are his people, and the sheep of his pasture. Enter his gates with thanksgiving, and his courts with praise!" --- Psalm 100:1-6, ESV

Some Questions for You

1. Who made the world? Who made us? *God did!*
2. What was the world like with God made it? *It was good. There was no sin in it; it was exactly as He had planned.*
3. Who rules over the world as king? *God does.*
4. Who keeps the world going and takes care of us? *God does.*
5. What did God give us to live by? *His good laws.*
6. Who knows the best way for us to live? *God does.*
7. Who should we worship, love, and obey? *God.*
8. God is our good king, but we all disobey Him. We deserve His punishment for our sins. But God is so merciful! He sent Jesus to save us! What must we do to be saved? *We can ask Him to help us to turn away from our sins and trust in Jesus as our Savior. He delights to do this!*

Let's Pray!

- A** God, we praise You for being the good Creator and King of the world.
- C** We confess that many times we rebel against You and Your good ways. We choose to live life our own way, instead. We need a Savior!
- T** Thank You for being our good Creator and King. Thank You for making everything in the world for Your good purposes. Thank You for being so merciful to us! Thank You for offering us salvation through Jesus, when we repent of our sins and trust Jesus as our Savior.
- S** God, work in our hearts. Help us to turn away from rebelling against You. Help us to trust in Jesus as our Savior. Help us to joyfully obey You, our good and great King. In Jesus' name we pray. Amen.

Let's Sing about What We're Learning!

Big Q & A 3 Song from *Deep Down Detectives ESV Songs 3, track 12*

(sung to the tune of "Oh, My Darlin' Clementine")

What's the gospel?
What's the gospel?
Can you tell me what it is?
It's salvation through faith in Jesus,
That's what the gospel is. (repeat)

Big Question 3 Action Rhyme Song from *Deep Down Detectives ESV Songs 3, track 13*

Refrain:

What is the gospel? G-O-S-P-E-L?	"G" is for God, our good King and Creator,	Yes, Jesus died upon the cross, the perfect sacrifice,
What is the gospel? Can anybody tell me?	O, we should obey Him, but instead we're disobeyers,	Then on Day Three, He rose again To prove He'd won the fight,
What is the gospel? Yes, I know what it is!	So S, we need a Savior to save us from our sins,	And now "E" everyone who repents and believes in Him,
Salvation through faith in Christ, That's what the gospel is.	That Savior is Jesus, who "P" took the punishment.	He gives "E-L" eternal life: forever life with Him. Refrain

Go to the *Deep Down Detectives Parent Resources for Unit 3* to get the Bible story and many more resources and songs for this unit at praisefactory.org
DDD BQ 3 BT 1 L1 Coloring Sheet/Take Home pg2

“Make a joyful noise to the LORD, all the earth! Serve the LORD with gladness!

Come into his presence with singing! Know that the LORD, he is God!

It is he who made us, and we are his; we are his people, and the sheep of his pasture.

Enter his gates with thanksgiving, and his courts with praise!” -- Psalm 100:1-6

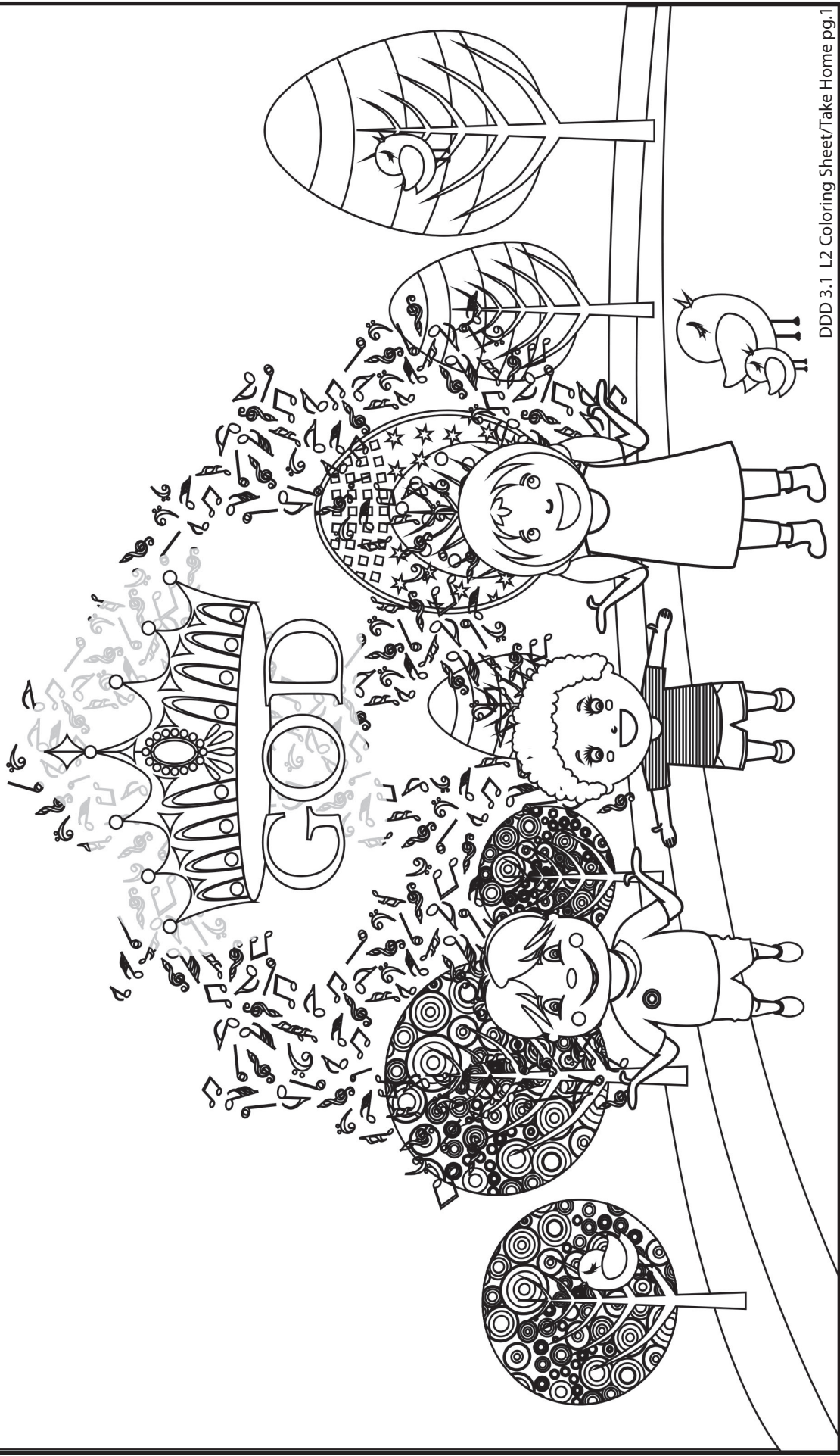

Deep Down Detective Devotion: Unit 3, Bible Truth 1, Lesson 2



Big Question 3: What Is the Gospel?

Answer: It's Salvation through Faith in Jesus Christ...God made us and we should obey Him!

How do I know this is true? The Bible tells me so!

"Make a joyful noise to the LORD, all the earth! Serve the LORD with gladness! Come into his presence with singing! Know that the LORD, he is God! It is he who made us, and we are his; we are his people, and the sheep of his pasture. Enter his gates with thanksgiving, and his courts with praise!" --- Psalm 100:1-6, ESV

Learn a Little: "Know that the LORD, he is God! It is he who made us."

Meaning

God's people are so happy about being His people! It's not enough for them to quietly worship Him. They want to make a joyful noise and sing loudly to Him. They want everyone--the whole earth--to praise God along with them. They want them to gather together with them at church and sing, sing, sing to the LORD, the great and good king! We can be God's people when we turn away from our sins and trust in Jesus as our Savior.

Some Questions for You

1. To whom should all the earth make a joyful noise? *To the LORD.*
2. Who made us and is our good king? *The LORD.*
3. Who loves to praise God? *God's people.*
4. Why do God's people love to praise Him? *For being their good God, who loves them, cares for them and has saved them.*
5. Where do God's people gather together to worship the LORD? *At church.*
6. What is the most amazing thing God has done for His people that they love to praise Him for? *For sending His Son, Jesus, to be their Savior and pay for their sins so they can be God's people.*
7. How can we become God's people? *By turning away from our sins and trusting in Jesus as our Savior. Ask God to help you do this! He loves to answer these prayers!*

Let's Pray!

- A** God, we praise You for being the good Creator and King of the world.
- C** We confess that many times we rebel against You and Your good ways. We choose to live life our own way, instead. We need a Savior!
- T** Thank You for being our good Creator and King. Thank You for making everything in the world for Your good purposes. Thank You for being so merciful to us! Thank You for offering us salvation through Jesus, when we repent of our sins and trust Jesus as our Savior.
- S** God, work in our hearts. Help us to turn away from rebelling against You. Help us to trust in Jesus as our Savior. Help us to joyfully obey You, our good and great King. In Jesus' name we pray. Amen.

Let's Sing Our Bible Verse!

Make a Joyful Noise: Psalm 100:1-6 from *Deep Down Detectives ESV Songs 3, track 19*

Refrain:

Make a joyful noise, make a joyful noise,
Make a joyful noise to the LORD, all the earth!
Make a joyful noise, make a joyful noise,
Make a joyful noise to the LORD, all the earth!

Verse 1

Serve the LORD with gladness!
Come into his presence with singing!
Know that the LORD, he is God!
It is he who made us, and we are his. Refrain

Verse 2

We are his people, and the sheep of his pasture.
O, Enter His gates, His gates with thanksgiving,
And his courts with praise! Refrain

Psalm One-hundred, one through six.

Which four of these clues belong in our story? Which two do not? Put an X in the boxes of the four that belong.

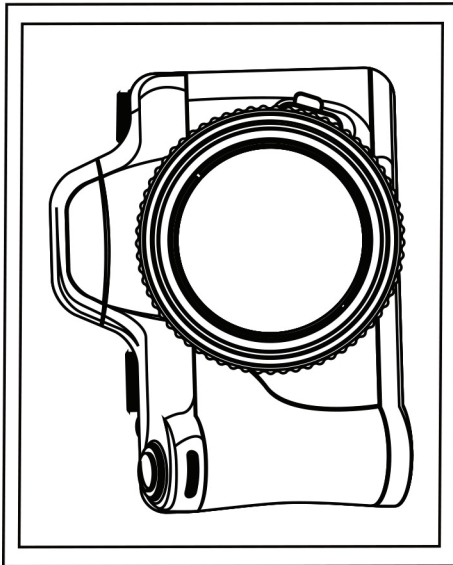

A Camera

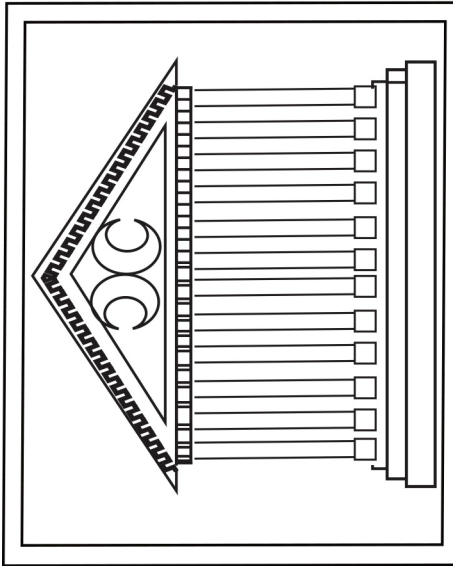

A Temple

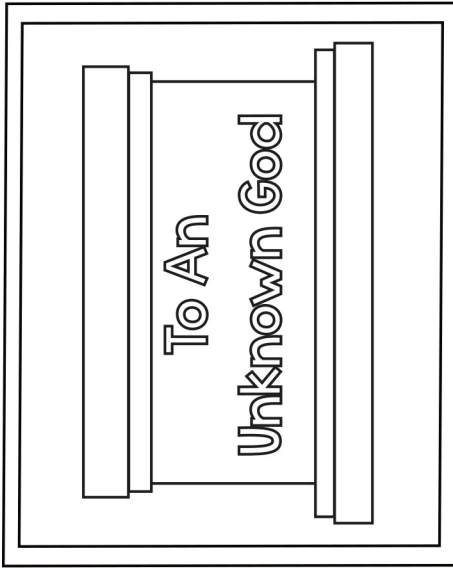

A Stone Altar

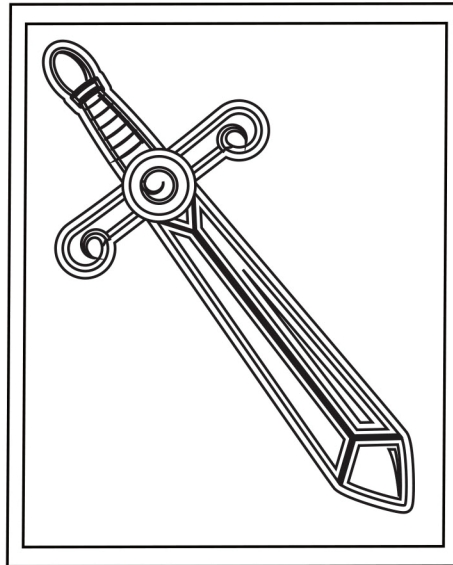

A Sword

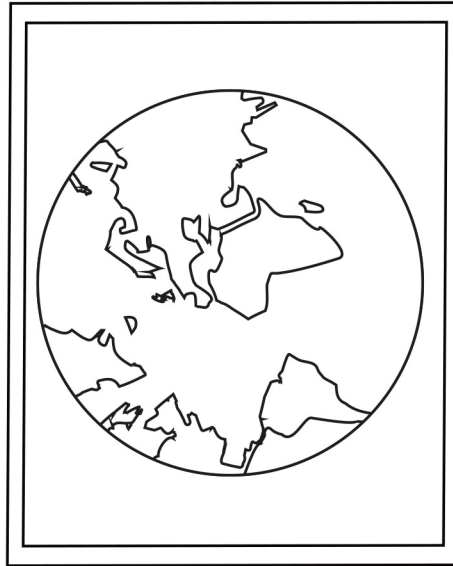

The World

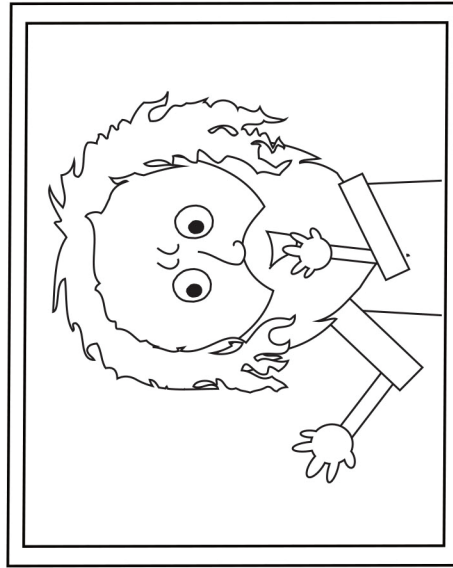

Laughing People

Answer: The temple; the stone; the world and the laughing people belong in the story. The camera and the sword do not.

Deep Down Detective Devotion: Unit 3, Bible Truth 1, Lesson 3



Big Question 3: What Is the Gospel?

Answer: It's Salvation through Faith in Jesus Christ...God made us and we should obey Him!

Bible Truth 1 Meaning

Who made the world and everything in it? God did! And when God created the world, He made it perfect. Everything He made was good. There was no sin in it. It was all just exactly as He planned. God isn't just our Creator. He is our King. He rules over everything He made. He takes care of us and keeps the world going. He gives us good laws to live by, and consequences if we disobey Him. God rules over the world in perfect wisdom and goodness. He always knows what is best for us. We should worship, love, and obey Him.

How do I know this is true? The Bible tells me so!

"Make a joyful noise to the LORD, all the earth! Serve the LORD with gladness! Come into his presence with singing! Know that the LORD, he is God! It is he who made us, and we are his; we are his people, and the sheep of his pasture. Enter his gates with thanksgiving, and his courts with praise!" --- Psalm 100:1-6, ESV

Some Questions for You

Our six case clues were: a camera; a temple; a stone altar; a sword; the world; and, laughing people.

1. Which four belong in our story?

The temple; stone altar; the world; and, laughing people.

2. What did the people of Athens need to confess to the LORD? Did any do this?

The people of Athens needed to confess that they had worshipped fake gods, not the LORD, the one, true God. They needed to trust in Jesus as their Savior.

3. Which of the people of Athens did confess their sins and trust in Jesus as their Savior? *Dionysius, Damaris and others did this.*

4. What do we need to confess to God? *That we, too, have chosen to disobey Him.*

5. What does God offer to do with our sins when we turn away from disobeying Him and trust in Jesus as our Savior? *He promises to forgive our sins and make us His people.*

Let's Pray!

- A** God, we praise You for being the good Creator and King of the world.
- C** We confess that many times we rebel against You and Your good ways. We choose to live life our own way, instead. We need a Savior!
- T** Thank You for being our good Creator and King. Thank You for making everything in the world for Your good purposes. Thank You for being so merciful to us! Thank You for offering us salvation through Jesus, when we repent of our sins and trust Jesus as our Savior.
- S** God, work in our hearts. Help us to turn away from rebelling against You. Help us to trust in Jesus as our Savior. Help us to joyfully obey You, our good and great King. In Jesus' name we pray. Amen.

Let's Praise God Right Now!

Big Q & A 3 Hymn: And Can It Be from *Deep Down Detectives ESV Songs 3, track 17*

Refrain

Amazing love, how can it be?

That thou, my God, should die for me?

Amazing love, how can it be?

That thou, my God, should die for me?

Words: Charles Wesley Music: Thomas Campbell

Big Question 3 Praise Song: I Have Decided to Follow Jesus from *Deep Down Detectives ESV Songs 3, track 18*

I have decided to follow Jesus,

I have decided to follow Jesus,

I have decided to follow Jesus,

No turning back, no turning back.

Go to the *Deep Down Detectives Parent Resources for Unit 3* to get the Bible story and many more resources and songs for this unit at praisefactory.org

CAN YOU GUESS BIBLE TRUTH 2:

What's the Gospel?

It's Salvation through Faith in Jesus Christ...

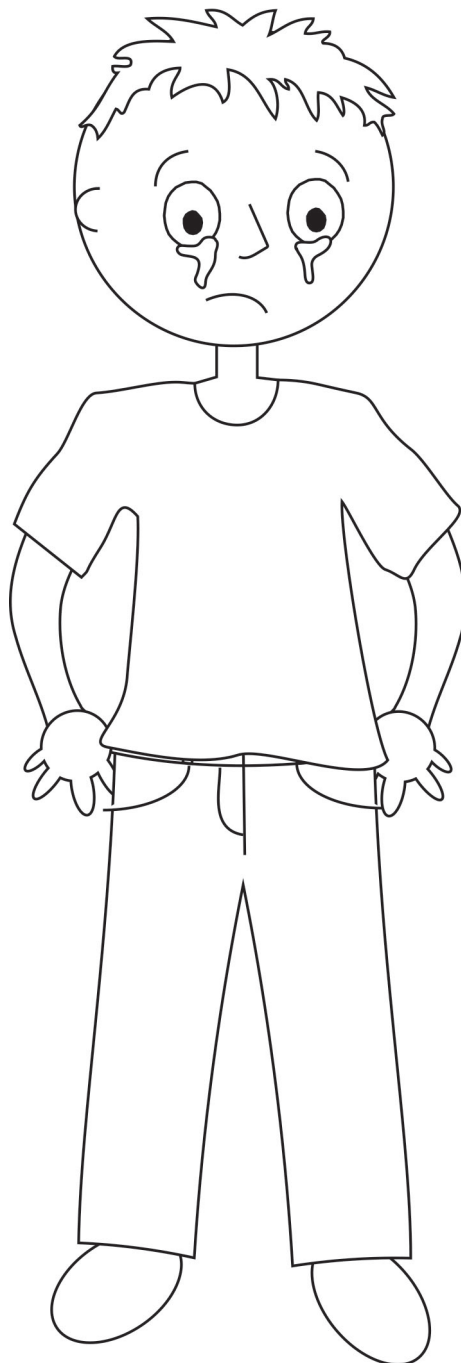

We have all disobeyed God and deserve His

----- !

HINT: "What we deserve when we do something wrong on purpose."

It's a sad word that rhymes with "compliment."

Deep Down Detective Devotion: Unit 3, Bible Truth 2, Lesson 1



Big Question 3: What is the Gospel?

Answer: It's Salvation through Faith in Jesus Christ... We Have All Disobeyed God and Deserve His Punishment!

Bible Truth 2 Meaning

God is our good Creator. He made us with a spirit, so we can know and love Him. He is our good King. He gave us good laws that show us how to love Him and love each other. The most wonderful life we can have is knowing and loving God. We were made to know Him and to live as He wants us to live. But instead of choosing God and His wonderful way of life, we have all chosen to disobey Him and His good laws. We have chosen to live life our own, selfish way, instead. This is what the Bible calls "sin". Because God is good, He hates sin, and He will punish it. And oh, how terrible is God's punishment for sin! It is to live apart from Him and everything good forever! Every single one of us deserve this punishment for our sins. But God isn't only good; He's merciful, too. Merciful means treating us better than we deserve, and that's just exactly how God offers to treat us. Yes, our sins must be punished, but God has chosen to take that punishment on Himself. That's why He sent Jesus, His own dear Son, to earth. Jesus came to take the punishment we deserved for our sins when He suffered and died on the cross. God promises to forgive all who turn away from their sins and trust in Jesus as their Savior. That can even include you and me! Isn't God amazing? How great is God's love for us!

How do I know this is true? The Bible tells me so!

"Surely there is not a righteous man on earth who does good and never sins... See, this alone I found, that God made man upright, but they have sought out many schemes." --- Ecclesiastes 7:20,29, ESV

Some Questions for You

1. Who is our good Creator? *God is.*
2. Who has chosen to disobey God and His good laws? *We all have.*
3. What do we deserve because we have disobeyed God? *We deserve His punishment--to be separated from Him and everything good forever.*
4. Who did God send to take the punishment for our sins in our place? *He sent Jesus.*
5. What do we need to do if we want to receive God's forgiveness for our sins? *We need to turn away from our sins and trust in Jesus as our Savior. God loves to forgive our sins and make us His people when we do.*

Let's Pray!

- A** God, we praise You for being the good God who hates sin.
- C** We confess that we have all rebelled against You and Your good ways. We have all chosen to live life our own way instead. We need a Savior!
- T** Thank You for not just being good, but for being merciful, too. Thank You for taking the punishment we deserve on Yourself that we might be saved. Thank You for offering us salvation through Jesus, when we repent of our sins and trust Jesus as our Savior.
- S** God, work in our hearts. Help us to turn away from living against You and Your good ways. Help us to trust in Jesus as our Savior. Help us to love You and know You. Help us to obey Your good laws. In Jesus' name we pray, Amen.

Let's Sing about What We're Learning!

Big Q & A 3 Song from *Deep Down Detectives ESV Songs 3, track 12*
(sung to the tune of "Oh, My Darlin' Clementine")

What's the gospel?
What's the gospel?
Can you tell me what it is?
It's salvation through faith in Jesus,
That's what the gospel is. (repeat)

Big Question 3 Action Rhyme Song from *Deep Down Detectives ESV Songs 3, track 13*

Refrain:

What is the gospel?
G-O-S-P-E-L?
What is the gospel?
Can anybody tell me?
What is the gospel?
Yes, I know what it is!
Salvation through faith in Christ,
That's what the gospel is.

"G" is for God,
our good King and Creator,
O, we should obey Him,
but instead we're disobeyers,
So S, we need a Savior
to save us from our sins,
That Savior is Jesus,
who "P" took the punishment.

Yes, Jesus died upon the cross,
the perfect sacrifice,
Then on Day Three, He rose again
To prove He'd won the fight,

And now "E" everyone who repents
and believes in Him,
He gives "E-L" eternal life: forever life with Him. *Refrain*

Go to the *Deep Down Detectives Parent Resources for Unit 3* to get the Bible story and many more resources and songs for this unit at praisefactory.org
DDD BQ 3 BT 2 L1 Coloring Sheet/Take Home pg2

**“Surely there is not a righteous man on earth
who does good and never sins...”**



**See, this alone I found, that God made man upright,
but they have sought out many schemes.”**

Ecclesiastes 7:20,29, ESV

Deep Down Detective Devotion: Unit 3, Bible Truth 2, Lesson 2



Big Question 3: What is the Gospel?

Answer: It's Salvation through Faith in Jesus Christ... We have all disobeyed God and deserve His punishment!

How do I know this is true? The Bible tells me so:

"Surely there is not a righteous man on earth who does good and never sins... See, this alone I found, that God made man upright, but they have sought out many schemes." --- Ecclesiastes 7:20,29, ESV

Learn a Little: "There is not a righteous man on earth who does good and never sins."

Meaning:

In the beginning, God created the heavens and the earth. He created it all good. Oh, how wonderful was the love that those first people had for God! Oh, how wonderful it was to know Him and to obey Him! The big Bible word for loving God and living His good way is "righteous."

But that's not the way things are now. Sadly, we all have chosen to disobey God. We want to do things our own way, not God's good way. We make sneaky schemes and plan how we can get what we want or do what we want, instead of what God wants. Our hearts are not full of love for God or for others as they should be.

No one is righteous anymore. No one, that is, except Jesus, God's Son. God sent Jesus live a perfect, righteous life and give it as the payment for our sins. We can have Jesus' righteousness and become one of God's people, when we turn away from our sins and trust in Jesus as our Savior. God loves to help us do this. Ask Him!

Some Questions for You

1. What was the world like in the beginning when God first created it? *It was good--all good.*
2. What did the first people (Adam and Eve) enjoy in the beginning? *They enjoyed knowing, loving and obeying God perfectly. They enjoyed being righteous.*
3. What is the big Bible word for loving God and living His good way? *Righteous.*
4. Who have all people chosen to disobey? *God and His good ways.*
5. Who do we want to please instead of God? *Ourselves.*
6. No one is righteous anymore, except for one person. Who is that? *Jesus.*
7. What was special about the life Jesus lived? *It was perfect. He never, ever disobeyed God.*
8. What did Jesus use His perfect life to do? *Jesus gave it up as the perfect payment for our sins. He wanted to save us so we could become God's people.*
9. How can we be forgiven our sins and become one of God's people? *By turning away from our sins and trusting in Jesus as our Savior.*

Let's Pray!

- A** God, we praise You for being the good God who hates sin.
- C** We confess that we have all rebelled against You and Your good ways. We have all chosen to live life our own way instead. We need a Savior!
- T** Thank You for not just being good, but for being merciful, too. Thank You for taking the punishment we deserve on Yourself that we might be saved. Thank You for offering us salvation through Jesus, when we repent of our sins and trust Jesus as our Savior.
- S** God, work in our hearts. Help us to turn away from living against You and Your good ways. Help us to trust in Jesus as our Savior. Help us to love You and know You. Help us to obey Your good laws. In Jesus' name we pray, Amen.

Let's Sing Our Bible Verse!

There Is Not a Righteous Man: Ecclesiastes 7:20,29 from *Deep Down Detectives* ESV Songs 3, track 22

There is not a righteous man on earth,
Who does good and never sins.
See, this alone I found, that God made man upright,
But they have sought,
Sought out many schemes.
Ecclesiastes Seven: twenty and twenty-nine.

Go to the Deep Down Detectives Parent Resources for Unit 3 to get the Bible story and many more resources and songs for this unit at praisefactory.org

Which four of these clues belong in our story? Which two do not? Put an X in the boxes of the four that belong.

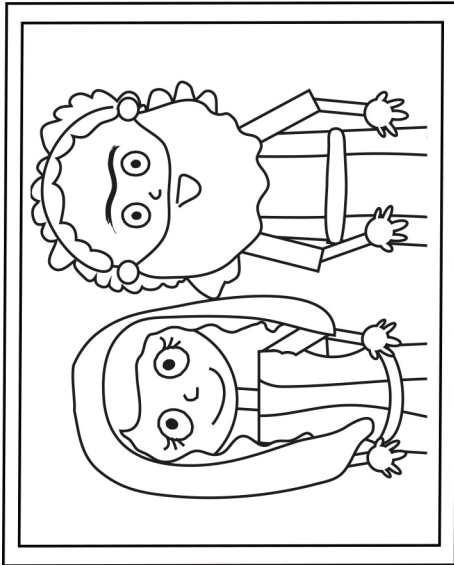

Jews

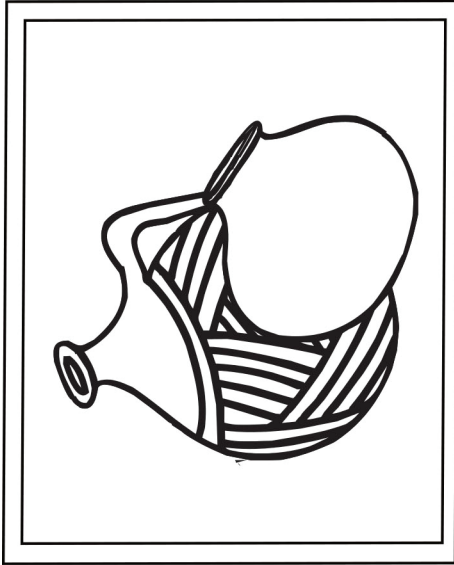

A Jar

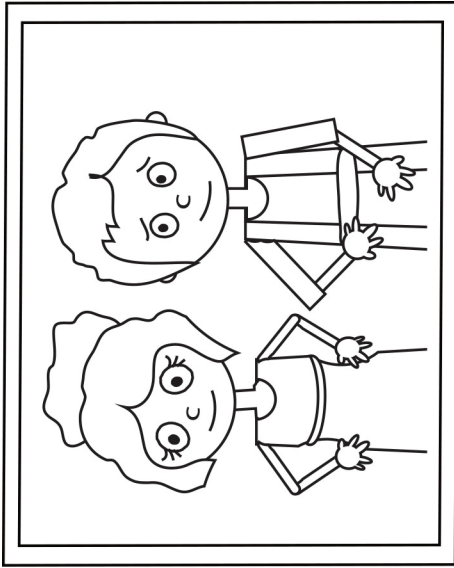

Gentiles

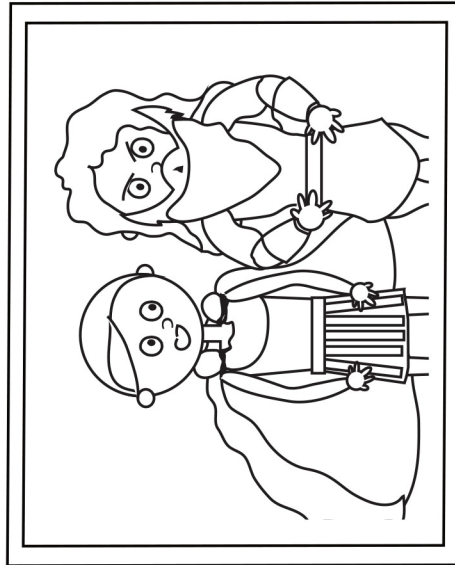

Fake Gods

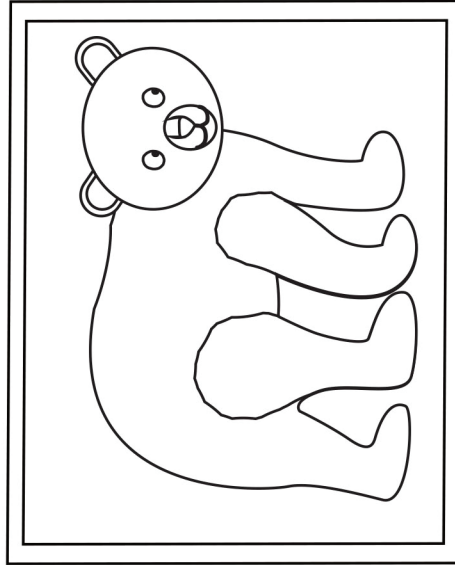

A Bear

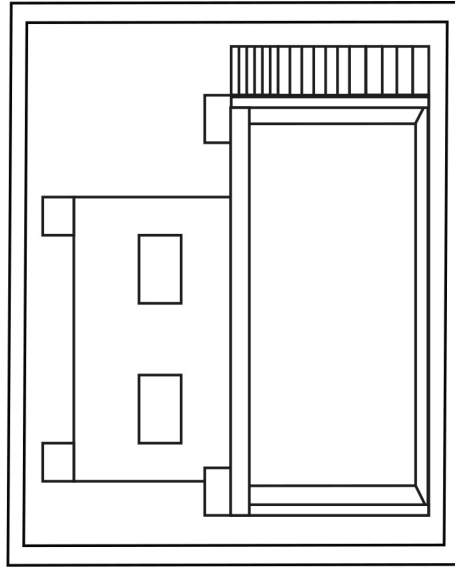

A House

Answer: The Jews; the Gentiles; the fake gods; and, the house belong. The jar and the bear do not.

Deep Down Detective Devotion: Unit 3, Bible Truth 2, Lesson 3

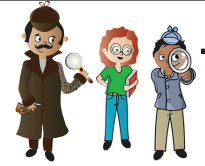

Big Question 3: What is the Gospel?

Answer: It's Salvation through Faith in Jesus Christ... We have all disobeyed God and deserve His punishment!

Bible Truth 2 Meaning

God is our good Creator. He made us with a spirit, so we can know and love Him. He is our good King. He gave us good laws that show us how to love Him and love each other. The most wonderful life we can have is knowing and loving God. We were made to know Him and to live as He wants us to live. But instead of choosing God and His wonderful way of life, we have all chosen to disobey Him and His good laws. We have chosen to live life our own, selfish way, instead. This is what the Bible calls "sin". Because God is good, He hates sin, and He will punish it. And oh, how terrible is God's punishment for sin! It is to live apart from Him and everything good forever! Every single one of us deserve this punishment for our sins. But God isn't only good; He's merciful, too. Merciful means treating us better than we deserve, and that's just exactly how God offers to treat us. Yes, our sins must be punished, but God has chosen to take that punishment on Himself. That's why He sent Jesus, His own dear Son, to earth. Jesus came to take the punishment we deserved for our sins when He suffered and died on the cross. God promises to forgive all who turn away from their sins and trust in Jesus as their Savior. That can even include you and me! Isn't God amazing? How great is God's love for us!

How do I know this is true? The Bible tells me so!

"Surely there is not a righteous man on earth who does good and never sins... See, this alone I found, that God made man upright, but they have sought out many schemes." --- Ecclesiastes 7:20,29, ESV

Some Questions for You

Our six case clues were: Jews; a jar; Gentiles; fake gods; a bear; and a house.

1. Which four belong in our story? *The Jews; Gentiles; fake gods; and the house.*

2. Who thanked God for saving them through Jesus?

Paul and the believers in Rome all thanked God for saving them through Jesus.

3, What is the big Bible word for loving God and living His good way? *Righteous.*

4. What was special about the life Jesus lived? *It was perfect. He never, ever disobeyed God. He was righteous.*

5. What did Jesus use His perfect life to do? *Jesus gave it up as the perfect payment for our sins.*

6. How can we be forgiven our sins and become one of God's people? *By turning away from our sins and trusting in Jesus as our Savior.*

Let's Pray!

- A** God, we praise You for being the good God who hates sin.
- C** We confess that we have all rebelled against You and Your good ways. We have all chosen to live life our own way instead. We need a Savior!
- T** Thank You for not just being good, but for being merciful, too. Thank You for taking the punishment we deserve on Yourself that we might be saved. Thank You for offering us salvation through Jesus, when we repent of our sins and trust Jesus as our Savior.
- S** God, work in our hearts. Help us to turn away from living against You and Your good ways. Help us to trust in Jesus as our Savior. Help us to love You and know You. Help us to obey Your good laws. In Jesus' name we pray, Amen.

Let's Praise God Right Now!

Big Q & A 3 Hymn: And Can It Be *from Deep Down Detectives ESV Songs 3, track 17*

Refrain

Amazing love, how can it be?

That thou, my God, should die for me?

Amazing love, how can it be?

That thou, my God, should die for me?

Words: Charles Wesley Music: Thomas Campbell

Big Question 3 Praise Song: I Have Decided to Follow Jesus *from Deep Down Detectives ESV Songs 3, track 18*

I have decided to follow Jesus,

I have decided to follow Jesus,

I have decided to follow Jesus,

No turning back, no turning back.

Go to the *Deep Down Detectives Parent Resources for Unit 3* to get the Bible story and many more resources and songs for this unit at praisefactory.org

DDD BQ 3 BT 2 L3 Coloring Sheet/Take Home pg2

CAN YOU GUESS BIBLE TRUTH 3:

What's the Gospel?

It's Salvation through Faith
in Jesus Christ...

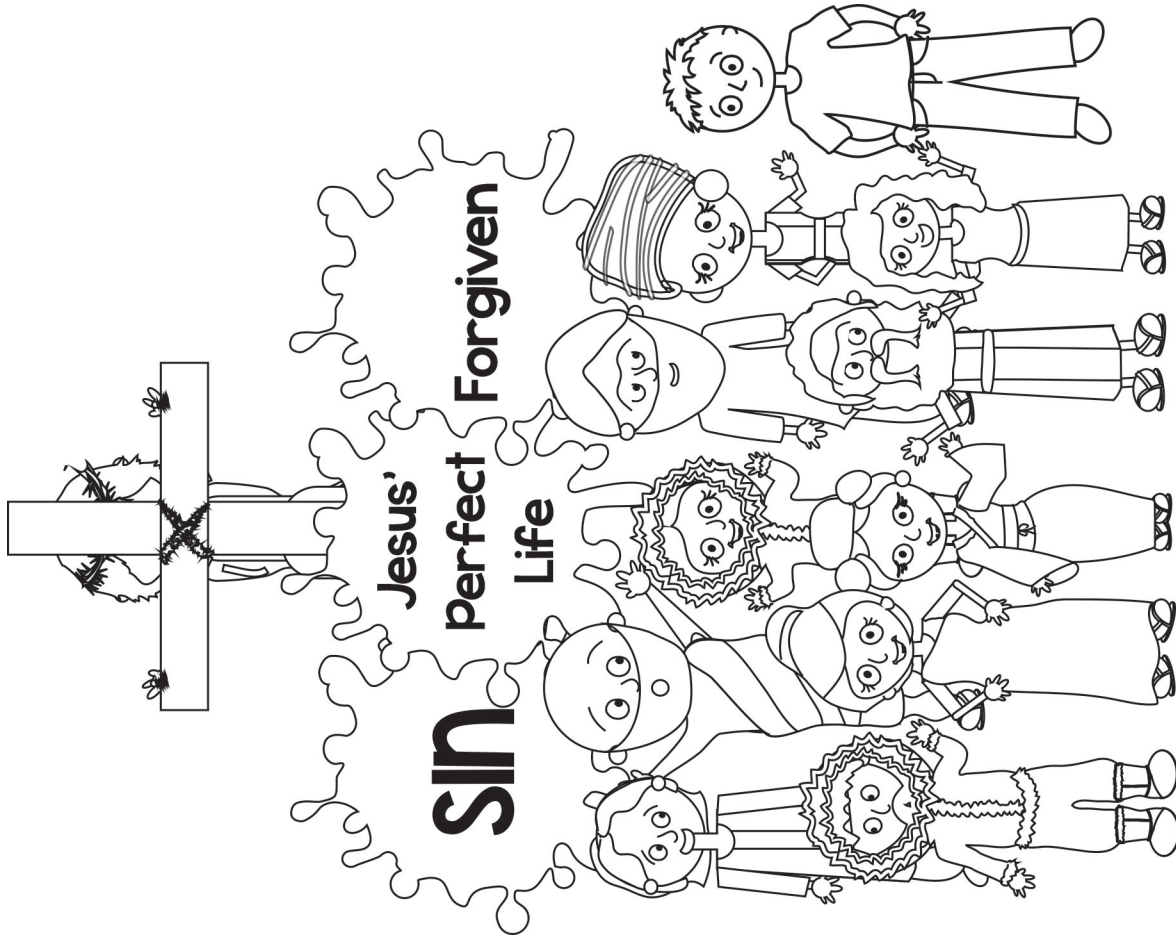

God sent ----- to pay for the sins of God's people!

HINT: What's the name of God's Son?

Deep Down Detective Devotion: Unit 3, Bible Truth 3, Lesson 1



Big Question 3 : What Is the Gospel?

Answer: It's Salvation through Faith in Jesus Christ... God sent Jesus to pay for the sins of God's people!

Bible Truth 3 Meaning

What a mess we have made in God's good world! God is our good Maker and King, yet we have all chosen to disobey Him. Because God is good, He hates sin and He is right to punish our sins. We certainly deserve it! The punishment for sins is death--being separated from God and all His goodness forever. How sad!

But God is not only good; He is also very merciful. He treats us better than we deserve. That's why God, Himself, made a way for us to be forgiven our sins and to become His people. God sent His own, dear Son, Jesus, to live the perfect life of love and obedience that we should live, but never do. On the cross, Jesus offered His perfect life to God as the full payment for sins, for all who turn away from their sins and trust in Him as their Savior. Jesus suffered and died in our place. Then on the third day, Jesus rose up from the dead, showing that He had really beaten sin and death! Jesus can be our Savior, too, when we turn away from our sins and trust in Him as our Savior.

How do I know this is true? The Bible tells me so!

"He was pierced for our transgressions, he was crushed for our iniquities; the punishment that brought us peace was upon him, and by his wounds we are healed. We all, like sheep, have gone astray, each of us has turned to his own way; and the LORD has laid on him the iniquity of us all."--- Isaiah 53:5-6, ESV

Some Questions for You

1. Who is our good Maker and King? *God is.*
2. Who has chosen to disobey God? *We all have.*
3. What does God hate, because He is good? *He hates sin.*
4. What is God right to do to with our sin, because He hates it (and it is bad)? *He is right to punish our sin.*
5. What is God's punishment for sins? *It is death--being separated from God and all His goodness forever.*
6. Who did God send because He is not just good, but merciful, too? *The Savior, Jesus.*
7. What did Jesus do on the cross to save us? *He gave His perfect life as the full payment for sin.*
8. How can Jesus be our Savior? *When we turn away from our sins and trust in Him as our Savior.*

Let's Pray!

- A** God, we praise You for being the good Creator and King of the world.
- C** God, we confess rebelling against You and Your good ways. Too many times we choose to live life our own way instead of Yours. We need a Savior!
- T** Thank You for being our good Creator and King. Thank You for making everything in the world for Your good purposes. Thank You for being so merciful to us! Thank You for offering us salvation through Jesus, when we repent of our sins and trust Jesus as our Savior.
- S** God, work in our hearts. Help us to turn away from disobeying You. Help us to trust in Jesus as our Savior. Help us to obey Your good ways and bring You glory. In Jesus' name we pray. Amen.

Let's Sing about What We're Learning!

Big Q & A 3 Song from Deep Down Detectives ESV Songs 3, track 12

(sung to the tune of "Oh, My Darlin' Clementine")

What's the gospel?
What's the gospel?
Can you tell me what it is?
It's salvation through faith in Jesus,
That's what the gospel is. (repeat)

Big Question 3 Action Rhyme Song from Deep Down Detectives ESV Songs 3, track 13

Refrain:

What is the gospel? G-O-S-P-E-L?	"G" is for God, our good King and Creator, O, we should obey Him, but instead we're disobeyers,	Yes, Jesus died upon the cross, the perfect sacrifice, Then on Day Three, He rose again To prove He'd won the fight,
What is the gospel? Can anybody tell me? What is the gospel? Yes, I know what it is! Salvation through faith in Christ, That's what the gospel is.	So S, we need a Savior to save us from our sins, That Savior is Jesus, who "P" took the punishment.	And now "E" everyone who repents and believes in Him, He gives "E-L" eternal life: forever life with Him. <i>Refrain</i>

Go to the Deep Down Detectives Parent Resources for Unit 3 to get the Bible story and many more resources and songs for this unit at praisefactory.org

DDD BQ 3 BT 3 L3 Coloring Sheet/Take Home pg2

**“He was pierced for our transgressions,
he was crushed for our iniquities;
the punishment that brought us peace was upon him,
and by his wounds we are healed. us all.”**

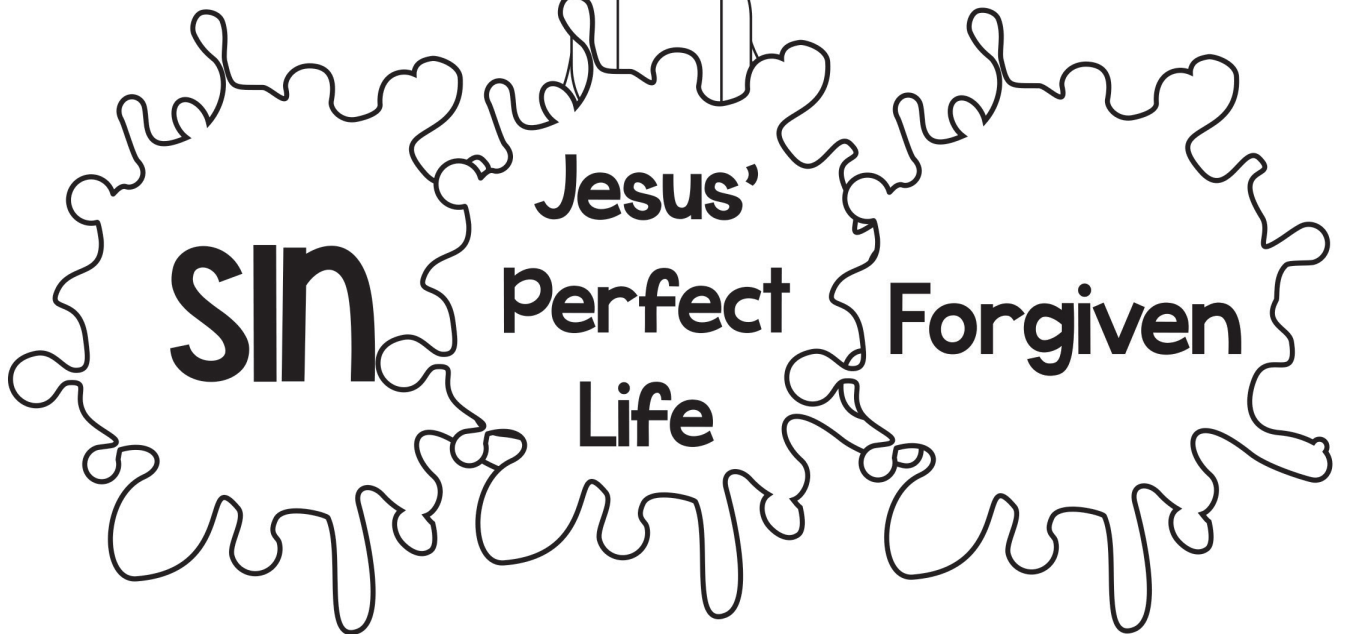
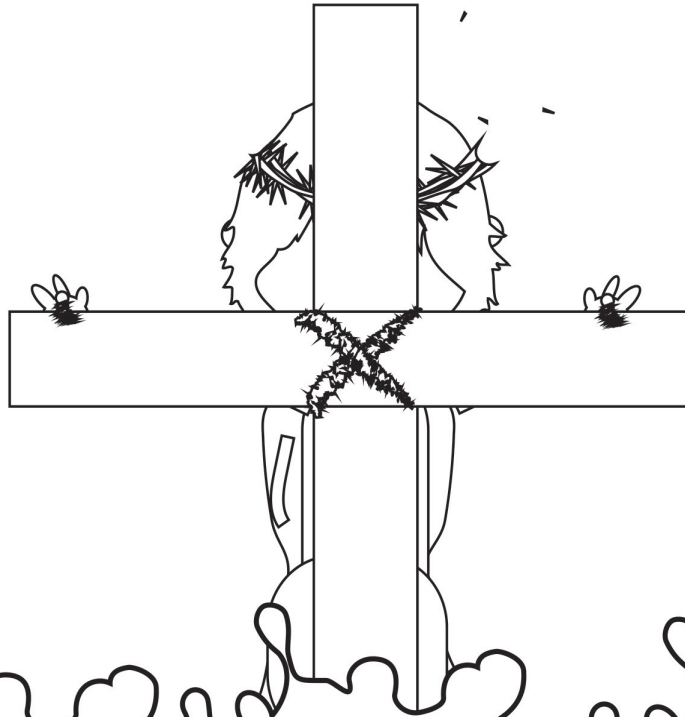

**We all, like sheep, have gone astray,
each of us has turned to his own way;
and the LORD has laid on him the iniquity of us all.”**

Isaiah 53:5-6, ESV

Deep Down Detective Devotion: Unit 3, Bible Truth 3, Lesson 2



Big Question 3 : What Is the Gospel?

Answer: It's Salvation through Faith in Jesus Christ... God sent Jesus to pay for the sins of God's people!

How do I know this is true? The Bible tells me so!

"He was pierced for our transgressions, he was crushed for our iniquities; the punishment that brought us peace was upon him, and by his wounds we are healed. We all, like sheep, have gone astray, each of us has turned to his own way; and the LORD has laid on him the iniquity of us all."--- Isaiah 53:5-6, ESV

Learn a Little: "The punishment that brought us peace was upon him."

Meaning

God is our good King and Creator and we should love and obey Him. But the sad news is that we all choose to disobey Him...and we all deserve His punishment.

Yes, we deserve His punishment, but God has loved us so much that He sent His Son, Jesus, to take the punishment that we deserve instead. Jesus lived a perfect life and chose to give it up to pay for our sins. On the cross, He suffered and died. He was pierced with nails in His hands and feet. He was pierced in His side with a sword. He took all of the punishment that we deserve from God for our sins so that we could be forgiven. Jesus made the way for us to have peace with God by suffering in our place.

Who did Jesus do this for? It is God's free gift to all who put their trust in Jesus as their Savior and choose to live for Him. This gift can be for you, too! Ask God to help you. He loves to answer this prayer!

Some Questions for You

1. Who has chosen to disobey God, our good King and Creator? *We all have.*
2. Who did God send to take the punishment for our sins? *His Son, Jesus.*
3. Where did Jesus take the punishment for our sins? *On the cross as He suffered and died.*
4. Who did Jesus suffer and die for? *For all who turn away from their sins and trust in Him as their Savior. It is God's free gift to all who do. It can be His gift to us, too!*

Let's Pray!

- A** God, we praise You for being the good Creator and King of the world.
- C** God, we confess rebelling against You and Your good ways. Too many times we choose to live life our own way instead of Yours. We need a Savior!
- T** Thank You for being our good Creator and King. Thank You for making everything in the world for Your good purposes. Thank You for being so merciful to us! Thank You for offering us salvation through Jesus, when we repent of our sins and trust Jesus as our Savior.
- S** God, work in our hearts. Help us to turn away from disobeying You. Help us to trust in Jesus as our Savior. Help us to obey Your good ways and bring You glory. In Jesus' name we pray. Amen.

Let's Sing Our Bible Verse!

He Was Pierced *from Deep Down Detectives ESV Songs 3 , track 24*

He was pierced, He was pierced,
He was pierced because of our transgressions,
He was crushed, He was crushed,
He was crushed because of our iniquities.

Punishment for our peace was on Him, on Him,
and by His wounds, we are healed, we are healed.

He was pierced, He was pierced,
He was pierced because of our transgressions,
He was crushed, He was crushed,
He was crushed because of our iniquities.
Isaiah Fifty-three, verse five.

Go to the Deep Down Detectives Parent Resources for Unit 3 to get the Bible story and many more resources and songs for this unit at praisefactory.org

Which four of these clues belong in our story? Which two do not? Put an X in the boxes of the four that belong.

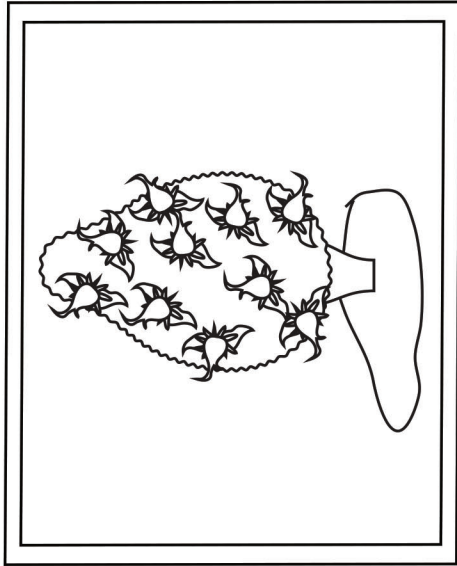

A Tree

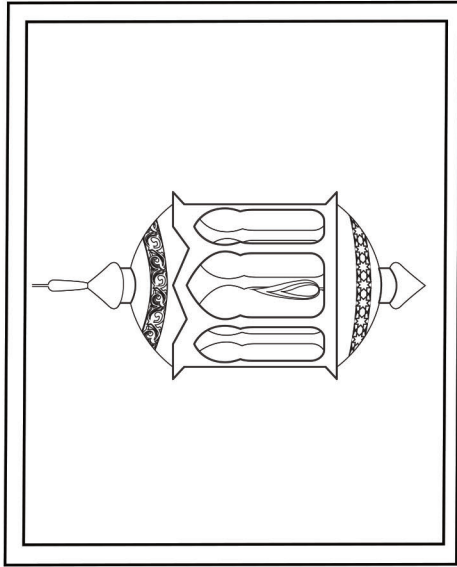

A Lamp

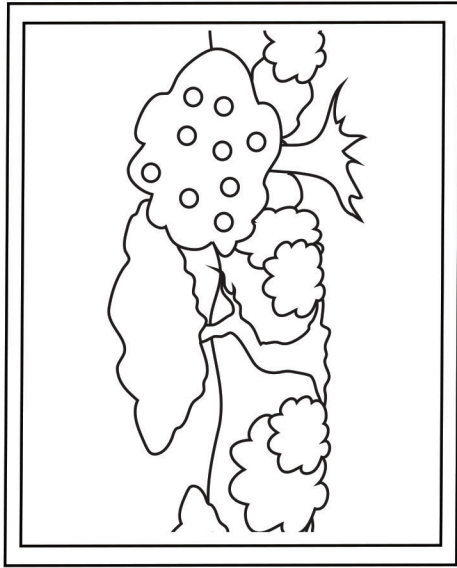

A Garden

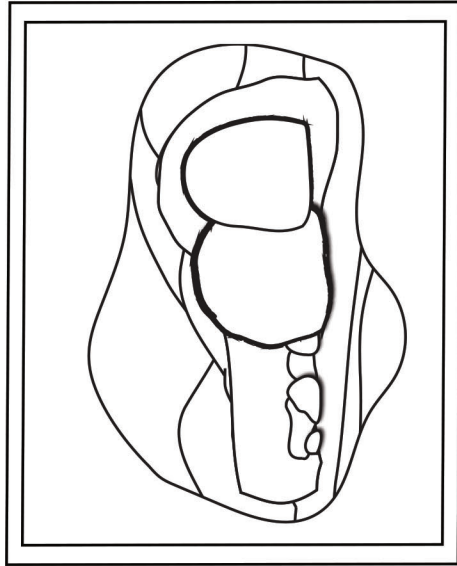

A Cave-grave

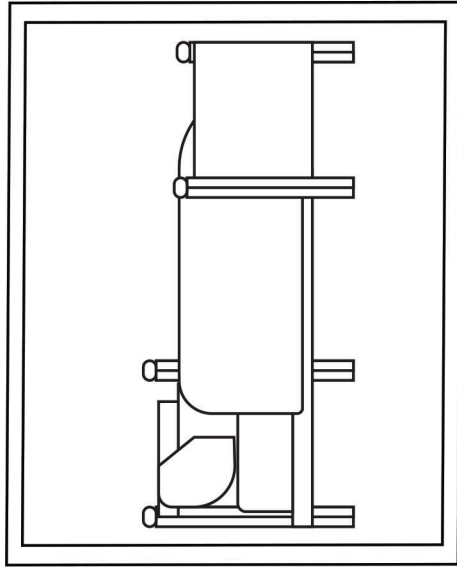

A Bed

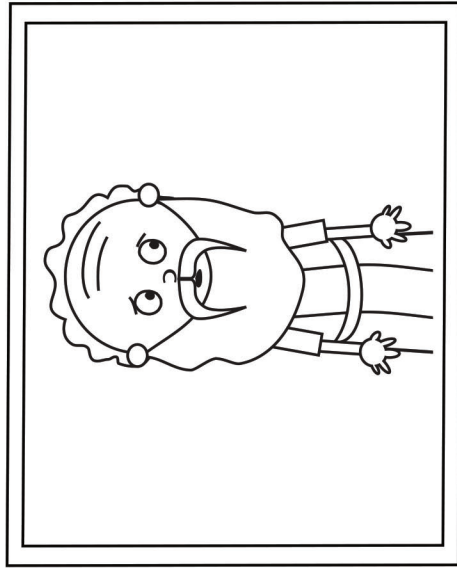

A Man Named Abraham

Answer: The tree; the garden; the cave-grave; and the man named Abraham belong. The lamp and the bed do not.

Deep Down Detective Devotion: Unit 3, Bible Truth 3, Lesson 3



Big Question 3 : What Is the Gospel?

Answer: It's Salvation through Faith in Jesus Christ... God sent Jesus to pay for the sins of God's people!

Bible Truth 3 Meaning

What a mess we have made in God's good world! God is our good Maker and King, yet we have all chosen to disobey Him. Because God is good, He hates sin and He is right to punish our sins. We certainly deserve it! The punishment for sins is death--being separated from God and all His goodness forever. How sad! But God is not only good; He is also very merciful. He treats us better than we deserve. That's why God, Himself, made a way for us to be forgiven our sins and to become His people. God sent His own, dear Son, Jesus, to live the perfect life of love and obedience that we should live, but never do. On the cross, Jesus offered His perfect life to God as the full payment for sins, for all who turn away from their sins and trust in Him as their Savior. Jesus suffered and died in our place. Then on the third day, Jesus rose up from the dead, showing that He had really beaten sin and death! Jesus can be our Savior, too, when we turn away from our sins and trust in Him as our Savior.

How do I know this is true? The Bible tells me so!

"He was pierced for our transgressions, he was crushed for our iniquities; the punishment that brought us peace was upon him, and by his wounds we are healed. We all, like sheep, have gone astray, each of us has turned to his own way; and the LORD has laid on him the iniquity of us all."--- Isaiah 53:5-6, ESV

Some Questions for You

Our six case clues were: a tree; a lamp; a garden; a cave-grave; a bed; and, a man named Abraham.

1. Which four belong in our story?

The tree, the garden, the cave-grave, and Abraham.

2. Which one did the Savior use to prove He had won? What do we thank Him for beating?

The cave-grave. On the third day Jesus rose from the dead, showing that He had beat sin and death for all who turn away from their sins and trust in Him as their Savior.

3. What did Adam and Eve lose when they disobeyed God? *They lost the perfect world they lived in. And, they lost the wonderful life they had with God.*

4. What did God promise to send Adam and Eve one day? *A Savior to save them from their sins.*

5. What did God use Abraham's family to do? *To be the family through whom the Savior would come. He would bless the whole world through this Savior.*

6. Who did God send at just the right time? *The Savior, Jesus.*

7. What did Jesus do with His perfect life to save us? *He gave it up to God as the full payment for sins as He suffered and died on the cross.*

8. How can Jesus be our Savior? *When we turn away from our sins and trust in Jesus as our Savior.*

Let's Pray!

A God, we praise You for being the good Creator and King of the world.

C God, we confess rebelling against You and Your good ways. Too many times we choose to live life our own way instead of Yours. We need a Savior!

T Thank You for being our good Creator and King. Thank You for making everything in the world for Your good purposes. Thank You for being so merciful to us! Thank You for offering us salvation through Jesus, when we repent of our sins and trust Jesus as our Savior.

S God, work in our hearts. Help us to turn away from disobeying You. Help us to trust in Jesus as our Savior. Help us to obey Your good ways and bring You glory. In Jesus' name we pray. Amen.

Let's Praise God Right Now!

Big Q & A 3 Hymn: And Can It Be

from Deep Down Detectives ESV Songs 3, track 17

Refrain

Amazing love, how can it be?

That thou, my God, should die for me?

Amazing love, how can it be?

That thou, my God, should die for me?

Words: Charles Wesley Music: Thomas Campbell

Big Question 3 Praise Song: I Have Decided to Follow Jesus

from Deep Down Detectives ESV Songs 3, track 18

I have decided to follow Jesus,

I have decided to follow Jesus,

I have decided to follow Jesus,

No turning back, no turning back.

Go to the *Deep Down Detectives Parent Resources for Unit 3* to get the Bible story and many more resources and songs for this unit at praisefactory.org

DDD BQ 3 BT 3 L3 Coloring Sheet/Take Home pg2

CAN YOU GUESS BIBLE TRUTH 4:
What's the Gospel?
It's Salvation through Faith
in Jesus Christ...

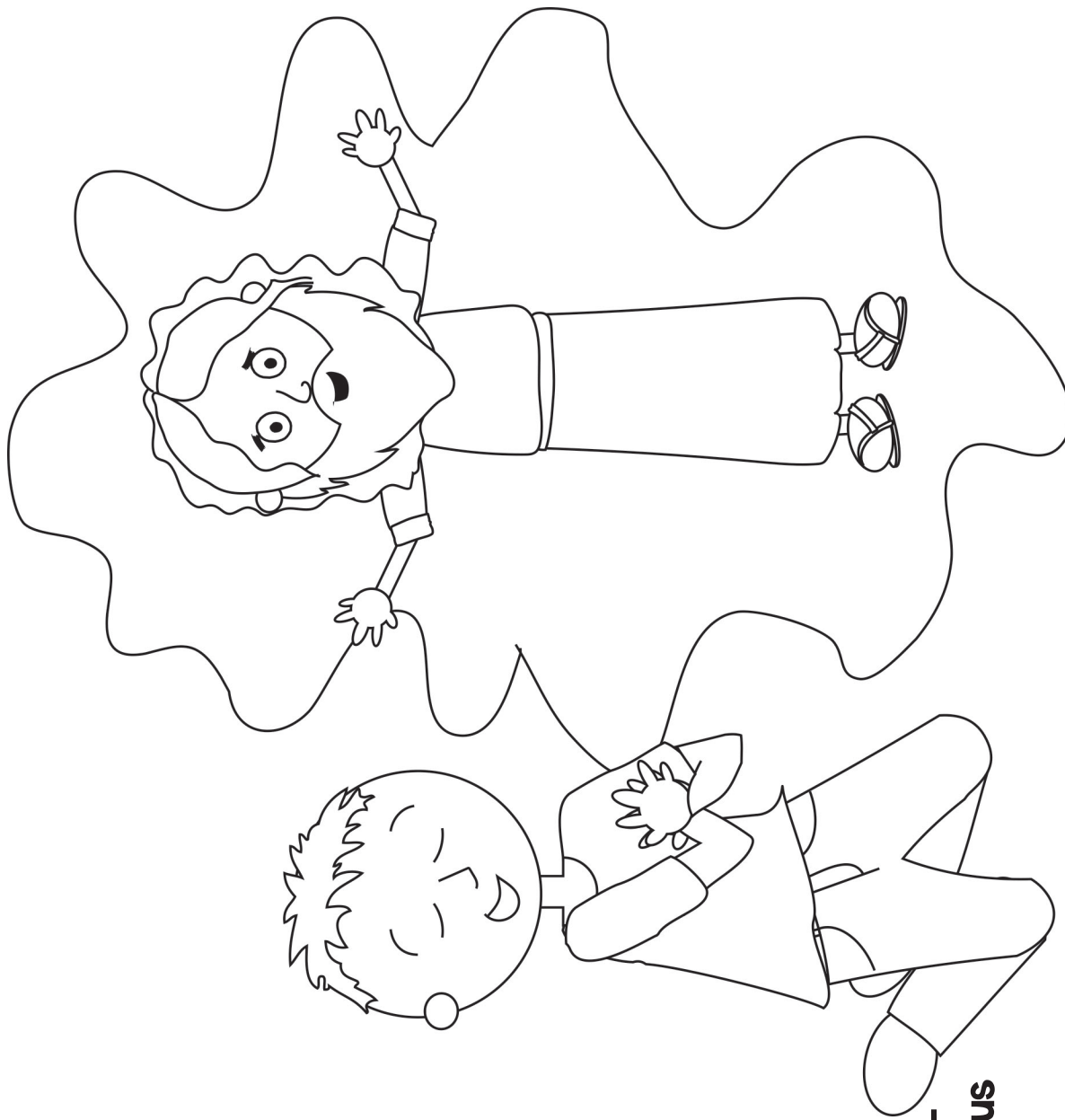

God saves all who

of their sins and trust in Jesus
as their Savior!

HINT: What's the Bible word for turning away from
disobeying God? It rhymes with "cement."

Deep Down Detective Devotion: Unit 3, Bible Truth 4, Lesson 1



Big Question 3 : What Is the Gospel?

Answer: It's Salvation through Faith in Jesus Christ...

God Saves All Who Repent of Their Sins and Trust in Jesus as Their Savior!

Bible Truth 4 Meaning

God is our good Creator and King. He made us to know Him, love Him and obey His good laws. But sadly, we all have chosen to disobey God and His good laws. We deserve His punishment for our sins. We have all turned away from Him. But God has made a way for us to be forgiven our sins and to become His people. In His great love and mercy, God sent His Son, Jesus, to be our Savior. Jesus lived a perfect life. He never disobeyed God. He offered up His life as the full payment for sin when He suffered and died on the cross. On the third day, He rose from the dead. Jesus had done it! He had beaten sin and death for God's people!

How can we become one of God's people? Who can receive God's gift of forgiveness? All who repent of their sins and trust in Jesus as their Savior. Repent means to stop living a life full of disobeying God and to start living to please God, instead. God can help us repent and believe. Ask Him! How wonderful it is to be one of God's people! To have special closeness with God by His Holy Spirit living in your heart now. And one day, to go live with God forever. That will be best of all!

How do I know this is true? The Bible tells me so!

"The time is fulfilled, and the kingdom of God is at hand; repent and believe in the gospel." --- Mark 1:15, ESV

Some Questions for You

1. Who is our good Creator and King? *Why do we deserve His punishment? God is our good Creator and King. We deserve His punishment because we have all chosen to disobey Him.*
2. What did God do so that we could be forgiven our sins, instead of punished for them? *He sent His Son, Jesus to be our Savior. Jesus suffered and died on the cross for our sins in our place.*
3. How can Jesus be our Savior? What do we need to do? *We need to repent of our sins and trust in Him as our Savior.*
4. What does it mean to repent of our sins? *To stop living a life of disobeying God and to start living to please God, instead.*
5. Who can help us repent and believe? *God can! Ask Him!*

Let's Pray!

- A** God, we praise You for being so full of love and mercy! You call us to repent and believe in Jesus that we might be saved.
- C** We confess that we often disobey You and Your good ways. We choose to live life our own way, not Yours. We need a Savior!
- T** Thank You, God, for offering us salvation through Jesus, when we repent of our sins and trust in Jesus as our Savior.
- S** God, work in our hearts. Help us to trust in Jesus as our Savior. Help us to joyfully obey You. You know what is best for us and what brings You glory. In Jesus' name we pray. Amen.

Let's Sing about What We're Learning!

Big Q & A 3 Song from Deep Down Detectives ESV Songs 3, track 12

(sung to the tune of "Oh, My Darlin' Clementine")

What's the gospel?
What's the gospel?
Can you tell me what it is?
It's salvation through faith in Jesus,
That's what the gospel is. (repeat)

Big Question 3 Action Rhyme Song from Deep Down Detectives ESV Songs 3, track 13

Refrain:

What is the gospel? G-O-S-P-E-L?	"G" is for God, our good King and Creator, O, we should obey Him, but instead we're disobeyers,	Yes, Jesus died upon the cross, the perfect sacrifice, Then on Day Three, He rose again To prove He'd won the fight,
What is the gospel? Can anybody tell me? What is the gospel? Yes, I know what it is! Salvation through faith in Christ, That's what the gospel is.	So S, we need a Savior to save us from our sins, That Savior is Jesus, who "P" took the punishment.	And now "E" everyone who repents and believes in Him, He gives "E-L" eternal life: forever life with Him. <i>Refrain</i>

Go to the Deep Down Detectives Parent Resources for Unit 3 to get the Bible story and many more resources and songs for this unit at praisefactory.org

DDD BQ 3 BT4 L1 Coloring Sheet/Take Home pg2

“The time is fulfilled, and the kingdom of God is at hand; repent and believe in the gospel.” --Mark 1:15, ESV



Deep Down Detective Devotion: Unit 3, Bible Truth 4, Lesson 2



Big Question 3 : What Is the Gospel?

Answer: It's Salvation through Faith in Jesus Christ...

God Saves All Who Repent of Their Sins and Trust in Jesus as Their Savior!

How do I know this is true? The Bible tells me so!

"The time is fulfilled, and the kingdom of God is at hand; repent and believe in the gospel." --- Mark 1:15, ESV

Learn a Little: "Repent and believe in the gospel."

Meaning

For years and years, God had promised to send a Savior to save us from our sins. For years and years, people waited and watched...and they watched and waited. At last, Jesus came! He taught the people about God and did amazing things. He showed them that He was God's Son, the Savior God had promised.

But what did people have to do, if they were to be forgiven by God for their sins? Jesus told them: "Repent and believe in the gospel--the good news that Jesus was God's Son, the Savior, sent to save them. We can be forgiven, too, when we repent (that is, turning away disobeying God and turning to live for God, instead) and believe that Jesus is God's Son, the Savior. God loves to help us do this. Ask Him!

Some Questions for You

1. What is God's kingdom? *God's people, living with God, as He wants them to live.*
2. What is the gospel? *It's the good news about the Savior, Jesus.*
3. Who did God promise to send at just the right time? *The Savior, Jesus.*
4. What did Jesus do when He came? *He told people about God and did amazing things. He showed them that He was the Savior. He suffered and died for our sins. He rose to life in victory.*
5. What did Jesus tell people to do, if they wanted to become God's people? *Repent of their sins and believe that He is the Savior.*
6. How does "repent" mean? *To turn away from disobeying God and live to please Him, instead.*
7. Who can help us repent and believe? *We can ask God to help us to turn away from our sins and trust in Jesus as our Savior. He loves to answer these prayers!*

Let's Pray!

- A** God, we praise You for being so full of love and mercy! You call us to repent and believe in Jesus that we might be saved.
- C** We confess that we often disobey You and Your good ways. We choose to live life our own way, not Yours. We need a Savior!
- T** Thank You, God, for offering us salvation through Jesus, when we repent of our sins and trust in Jesus as our Savior.
- S** God, work in our hearts. Help us to trust in Jesus as our Savior. Help us to joyfully obey You. You know what is best for us and what brings You glory. In Jesus' name we pray. Amen.

Let's Sing Our Bible Verse!

The Time Is Fulfilled from *Deep Down Detectives* ESV Songs 3, track 26

The time is fulfilled,
The time is fulfilled,
And the kingdom of God is at hand.
The time is fulfilled,
The time is fulfilled,
And the kingdom of God is at hand.

Repent and believe,
Repent and believe in the gospel,
Repent and believe,
Repent and believe in the gospel,
Repent and believe. (repeat)
Mark Chapter One, verse fifteen.

DDD BQ 3 BT4 L2 Coloring Sheet/Take Home pg2

Go to the *Deep Down Detectives* Parent Resources for Unit 3 to get the Bible story and many more resources and songs for this unit at praisefactory.org

Which four of these clues belong in our story? Which two do not? Put an X in the boxes of the four that belong.

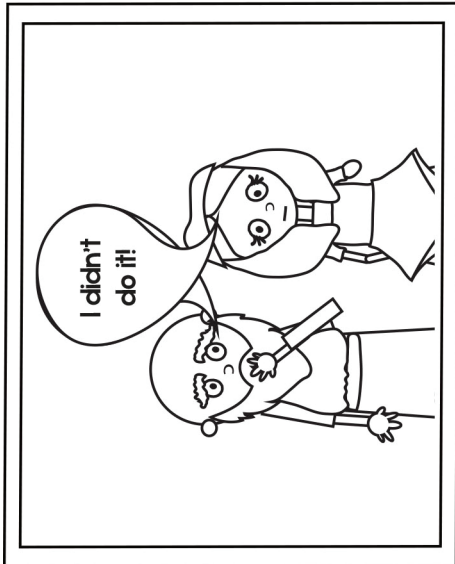

A Liar

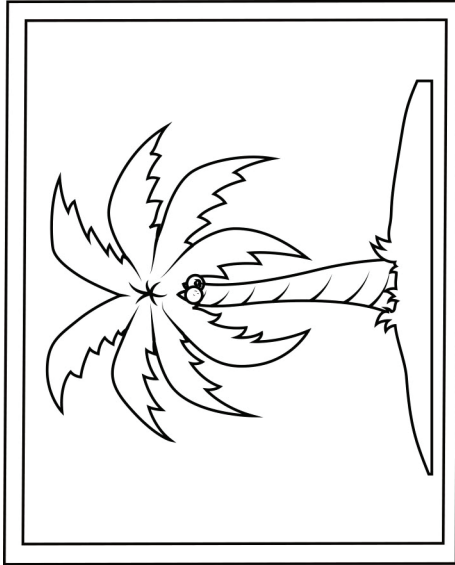

A Palm Tree

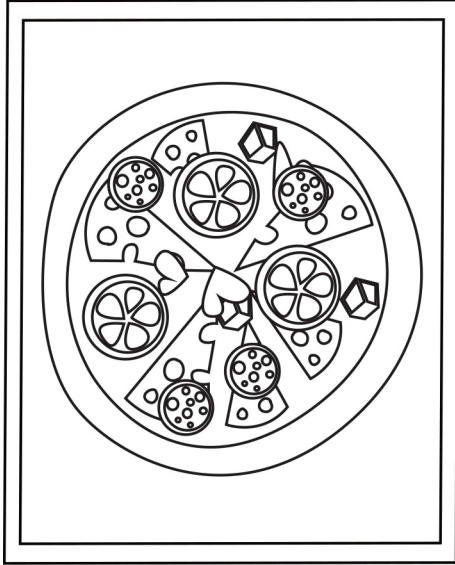

A Pizza

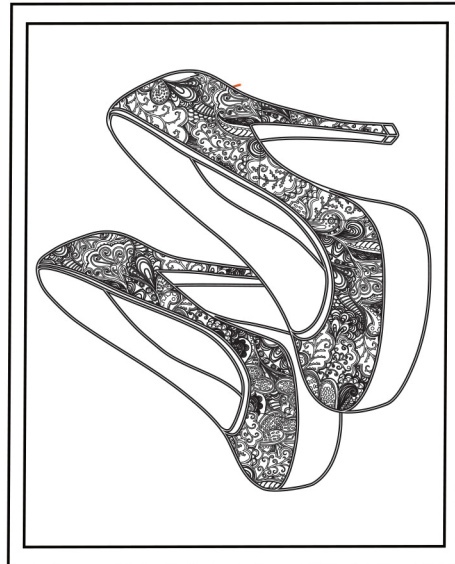

A Pair of Shoes

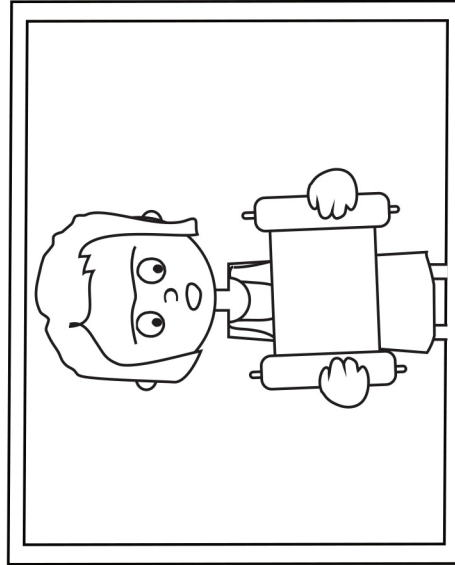

A Man Named Titus

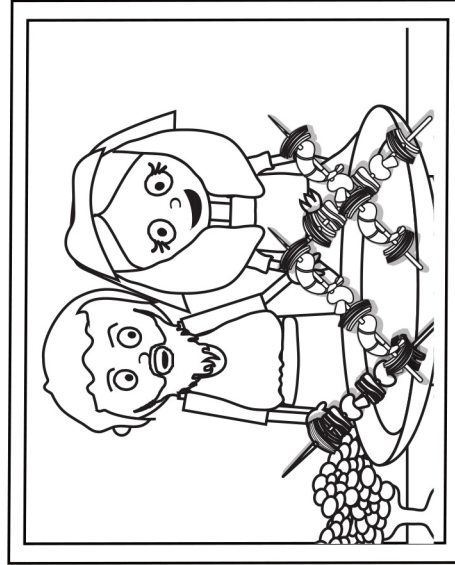

A Lazy, Over-eater

Answer: The liar; the palm tree; Titus; and, the lazy, over-eater belong in the story. The pizza and shoes do not.

Deep Down Detective Devotion: Unit 3, Bible Truth 4, Lesson 3



Big Question 3 : What Is the Gospel?

Answer: It's Salvation through Faith in Jesus Christ...

God Saves All Who Repent of Their Sins and Trust in Jesus as Their Savior!

Bible Truth 4 Meaning

God gave every person a heart to know and love Him. He made all sorts of wonderful things in the world around them to see what He is like. But when people saw Jesus and all He did and said, they were seeing what God is like more than ever before. Why? Because Jesus IS God! When we hear the stories of Jesus in the Bible, we can know more of what God is like, too!

How do I know this is true? The Bible tells me so!

"The time is fulfilled, and the kingdom of God is at hand; repent and believe in the gospel." --- Mark 1:15, ESV

Some Questions for You

Our six case clues were: a liar; a palm tree; a pizza; a pair of shoes; a man named Titus; and, a lazy, over-eater.

1. Which four belong in our story? *The liar; the palm tree; Titus; and, the lazy, over-eater.*

2. What made Crete so cruddy? *The people were sinners who chose to live their own way instead of God's good way. They were especially known for being liars, cheats, and lazy over-eaters.*

3. What did Paul and Titus come to tell them? *The good news of Jesus that they might be saved.*

4. What two things did Paul tell them they needed to do, if they were to be saved? *Repent of their sins and believe in Jesus as their Savior.*

5. How does "repent" mean? *To turn away from disobeying God and live to please Him, instead.*

6. Why would it be hard for the people of Crete to repent of their sins? *They would have to stop living the way they had been living and start living a completely different way.*

7. Who helped the people of Crete repent and believe? *God did. His Holy Spirit worked in their hearts as they listened to Paul preach.*

8. Who stay to help the new believers in Crete? *Titus did.*

9. How did Paul encourage the new believers when he heard they were struggling? He wrote them a letter and urged them to keep on believing in God and keep on repenting. He told them God would help them.

Let's Pray!

- A** God, we praise You for being so full of love and mercy! You call us to repent and believe in Jesus that we might be saved.
- C** We confess that we often disobey You and Your good ways. We choose to live life our own way, not Yours. We need a Savior!
- T** Thank You, God, for offering us salvation through Jesus, when we repent of our sins and trust in Jesus as our Savior.
- S** God, work in our hearts. Help us to trust in Jesus as our Savior. Help us to joyfully obey You. You know what is best for us and what brings You glory. In Jesus' name we pray. Amen.

Let's Praise God Right Now!

Big Q & A 3 Hymn: And Can It Be

from *Deep Down Detectives ESV Songs 3, track 17*

Refrain

Amazing love, how can it be?

That thou, my God, should die for me?

Amazing love, how can it be?

That thou, my God, should die for me?

Words: Charles Wesley Music: Thomas Campbell

Big Question 3 Praise Song: I Have Decided to Follow Jesus

from *Deep Down Detectives ESV Songs 3, track 18*

I have decided to follow Jesus,

I have decided to follow Jesus,

I have decided to follow Jesus,

No turning back, no turning back.