

DEEP DOWN DETECTIVES



Unit 13

Simple Story Scenes, ESV

The God Who Sustains



Curriculum for preschool and elementary age children,
training tools, music and other resources
are available for download or to order at:
www.praisefactory.org

© 2023 Praise Factory Media all rights reserved. May be reproduced by licensed user for classroom purposes only.

This and many other resources are available online at www.praisefactory.org

Scripture quotations marked (NIV) are taken from the Holy Bible, New International Version®, NIV®, Copyright © 1973, 1978, 1984 by Biblica, Inc.™ Used by permission of Zondervan. All rights reserved worldwide.www.zondervan.com

Scripture quotations marked (ESV) are from The Holy Bible, English Standard Version® (ESV®), copyright © 2001 by Crossway, a publishing ministry of Good News Publishers. Used by permission. All rights reserved.

Scripture quotations marked HCSB are taken from the Holman Christian Standard Bible®, Copyright © 1999, 2000, 2002, 2003, 2009 by Holman Bible Publishers. Used by permission. Holman Christian Standard Bible®, Holman CSB®, and HCSB® are federally registered trademarks of Holman Bible Publishers.

Table of Contents

About the Deep Down Detectives Visual Aids	5
Unit 13: The God Who Sustains	
Why Do God’s People Keep Believing in Him? It Is God’s Sustaining Grace...	
Bible Truth 1: God Alone Sustains His People	9
Bible Truth 1 Overview	11
Story Scenes	13
Bible Truth 2: God the Father Promises to Help His People	67
Bible Truth 2 Overview	69
Story Scenes	71
Bible Truth 3: Jesus Provides God’s People with Everything They Need to Live for God	133
Bible Truth 3 Overview	135
Story Scenes	137
Bible Truth 4: The Holy Spirit Works in His People	197
Bible Truth 4 Overview	199
Story Scenes	201
Bible Truth 5: The Word of God Grows God’s People	245
Bible Truth 5 Overview	247
Story Scenes	249
Bible Truth 6: God Uses His People to Strengthen and Comfort Each Other	313
Bible Truth 6 Overview	315
Story Scenes	317
Take-Home Sheets	359
Bible Truth 1	361
Bible Truth 2	367
Bible Truth 3	373
Bible Truth 4	379
Bible Truth 5	385
Bible Truth 6	391

About the Deep Down Detectives Visual Aids

How Are They Used?



The Deep Down Detectives Visual Aids book is a companion resource to be used alongside the Deep Down Detectives Core Curriculum book for each unit. These colorful pictures are used in presenting the key concepts; telling the Bible stories; and, in playing the Bible Story Review games.

What Do They Include?



There are four, different resources included in this book:

1. Key Concept Visual Aids-- colorful signs of the Big Question and Answer, the Bible Truth, the Bible verse, and the Listening Assignments to use with the 3 lessons for each Bible Truth.

2. The Story Scenes. Notice that each scene is numbered and that there is a brief summary of the story that corresponds to the picture. You can actually just tell the story in a simple way by using only the text at the bottom of each Story Scene.

3. Take-Home Sheets for each Bible Truth.

4. Directions for making the Deep Down Detectives "Bible" Folder and the **back/front images** to paste in place when making it. (Larger back/front images are found online with the curriculum.)

Directions for how to make a homemade flannelgraph storyboard and sturdy Story Scene pictures are found in the back of this book.

Ready, Set, Rip It Out!

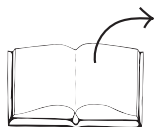

This book is meant to be ripped up and made into your visual aids. The key concept signs can be cut out and laminated or slipped into sheet protectors. The Story Scenes can be put in sheet protectors or laminated, too.

Store It!



Deep Down Detectives is a curriculum that can be used over and over. Store your visual aids and storyboard pictures after using them and they will serve you for many years. We store ours in manilla envelopes and then put them (along with all the rest of the curriculum) in magazine files, labelled by Bible Truth. If you have multiple classes using the curriculum, store each set of resources in separate manilla envelopes. This will make prep much simpler, second time around.

Replacement Story Scene Pictures



You can always purchase this book again or simply go online and print out any scenes that go missing.

Other Options

You can also choose to tell the story in a more traditional flannelgraph way by using your own flannelgraph figures or by purchasing/free downloading the Storyboard Pictures (large and small format size available). This is more complex and requires more preparation, but some love it. And, it does allow for kids to interact more by helping to place pictures up on the board as you tell the story.

Deep Down Detectives Curriculum Resources

There are five companion resources for each of the sixteen units of Deep Down Detectives. Use whichever resources are useful to your setting. Deep Down Detectives resources are available as free, digital downloads at praisefactory.org, or for purchase as hard copies through amazon.com.

Make sure to check out the “Bits and Pieces” section of the Deep Down Detectives curriculum online. It has all of the resources separated out making it easy for you simply to pick, choose and print out whatever you want.

Deep Down Detectives Core Curriculum Book, ESV/NIV for each unit

The Deep Down Detectives Core Curriculum book contains the curriculum introduction, the lesson plans, stories, music, activities and take home sheets for each of the units.

Deep Down Detectives Visual Aids with Simple Story Scenes, ESV/NIV for each unit

This resource provides large, colorful signs of the key concepts used in the unit, PLUS, easy-to-use, colorful scenes that you hold up in sequence as you tell the story. The story text for each scene is printed on the bottom of each scene.

Deep Down Detectives Simple Story Scenes, ESV/NIV for each volume

This resource includes only 2-page overview for Bible Truth, the story scenes, and take home sheets. This is a great, basic resource for use at home and in many classroom teaching situations.

Deep Down Detectives Small Format Visual Aids, ESV/NIV (Small Format Storyboard Pictures) for each volume

This resource provides large, colorful signs of the key concepts used in the unit, PLUS, colorful storyboard (flannelgraph) pictures to cut out and use as you tell each story. These storyboard pictures are for use with storyboards at least 24" x 36" in size.

Deep Down Detectives Large Format Visual Aids, ESV/NIV (Large Format Storyboard Pictures) for each volume

This resource provides large, colorful signs of the key concepts used in the unit. It also provides colorful storyboard (flannelgraph) pictures to cut out and use as you tell each story. These storyboard pictures are for use with storyboards 36" x 48" in size.

All of these materials may be photocopied for non-commercial church, classroom or school use by licensed users.

Other Resources in the Praise Factory Family of Curriculum

Deep Down Detectives is the second in a family of three, inter-related curriculums:

- Hide 'n' Seek Kids (focus group: ages 2-4; adaptable range: ages 2-pre-K 5's)
- Deep Down Detectives (focus group: ages 4--6's; adaptable range: ages 3-2nd grade)
- PFI: (focus group: grades K-5th grade; adaptable range: pre-K 5's-6th grade)

Each curriculum teaches the same biblical themes, but are presented in greater depth as the children grow and develop. Together, the curriculums work like an expanding spiral of truth that returns to reinforce the same truths with each curriculum, yet leading the children to deeper understanding with each step up.

Learn more about these curriculums as well as other resources and ideas for reaching children with the gospel at: www.praisefactory.org.

Unit 13: The God Who Sustains

UNIT OVERVIEW

All people enjoy many good things and suffer many bad or sad things in this world. Enjoying good things or going through bad things make some people turn away from God. They love the good things too much or get mad at God for the bad things that happen.

But that's not what happens with God's people. They have put their trust in Jesus. They want to love God most of all, even more than the good things they enjoy. They trust God and His good plans, even as they go through bad or sad things.

What makes the difference? It's God and His sustaining grace! That is, His gifts of strength to help us keep on believing in Him and living for Him. God will always give His people what they need! He wants them to depend on Him and He loves for them to ask for His help. He will never fail them. God will help you like this, too, if you turn away from your sins and put your trust in Jesus.

In this unit we will learn six ways God sustains His people.

UNIT BIBLE VERSE: Psalm 55:22, ESV

"Cast your burden on the LORD, and he will sustain you; he will never permit the righteous to be moved."

BIG QUESTION UNDER INVESTIGATION: Why Do God's People Keep Believing in Him?

ANSWER: It Is God's Sustaining Grace!

OPTIONAL Big Question 13 INTRODUCTION LESSON (Use Hide 'n' Seek Kids Unit 13 Material)

Story: The Case of the People Who Wouldn't Stop *Acts 17, 1 & 2 Thessalonians*

Bible Verse: Psalm 55:22, ESV

BIBLE TRUTH 1: God Alone Sustains His People (3 Lessons Available)

Story: The Case of the Impossible, Big, Bad, Scary News *Genesis 37:12-36; 39-50; Exodus 1-15*

Bible Verse: Jude 1:24-25, ESV

BIBLE TRUTH 2: God, the Father, Promises to Help His People (3 Lessons Available)

Story: The Case of the Really Bad Remember-ers

Exodus 5-15, 19-20, 24; Numbers 13-14; Joshua 1-5

Bible Verse: Psalm 54:4, 7, ESV

BIBLE TRUTH 3: Jesus Provides God's People with Everything They Need to Live for God

(3 Lessons Available)

The Case of the Man in the Middle *Leviticus 6, 16; Matthew 27; Hebrews 1-5, 9, 10, 18*

Bible Verse: Hebrews 4:15-16, ESV

BIBLE TRUTH 4: The Holy Spirit Works Inside of God's People (3 Lessons Available)

Story: The Case of the Foolish Forgetters *Galatians*

Bible Verse: 2 Corinthians 1:21-22, ESV

BIBLE TRUTH 5: The Word of God Feeds God's People (3 Lessons Available)

Story: The Case of the Confused Christians *Colossians*

Bible Verse: Romans 15:4, ESV

BIBLE TRUTH 6: God Uses His People to Strengthen and Comfort Each Other (3 Lessons Available)

Story: The Case of the Prayed-for Prisoner *Philippians*

Bible Verse: 2 Corinthians 1:3-4, 10-11, ESV

Deep Down Detectives ESV Songs 13 Track Numbers

This is a listing of all songs mentioned in the unit curriculum. You may or may not choose to use all of the songs. They are listed in easy-reference order--NOT in the order used in the curriculum. You may choose to simply burn a CD/load them onto an mp3 device in this order. Or, you may want to do what we do: choose the songs we want to use and create a play list of them in that order. Then, we burn a CD/upload the play list onto an mp3 device. A teacher only has to click forward to the next song, instead of hunting for the right track. The track number have been included as part of the title of each song, teachers will still have a reference to the track number listed in the curriculum (same as those listed below), even if you change the order on your customized play list.

SONGS USED EVERY UNIT OF THE CURRICULUM

- 1 The Classroom Song v.1
- 2 The Classroom Song v.2
- 3 The Classroom Song v.3
- 4 The Classroom Song v.4
- 5 Deep Down Detectives Theme Song
- 6 The Classroom Rules Song
- 7 Let's Pray Song
- 8 The Big Question Box Song
- 9 The Bible Chant Song
- 10 ACTS Prayer Song (Short Version)
- 11 ACTS Prayer Song (Full Version)

listen to or download songs for free at [https://praisefactory.org: Deep Down Detectives Music page](https://praisefactory.org:Deep Down Detectives Music page)

Why the Extra Songs?

Deep Down Detectives is a curriculum used by a wide age-span of kids. Sometimes one of the other songs is a better fit for your kids. Or, you may simply want to teach them more songs on the same Bible Truth. Use as many or as few as you want.

UNIT 13: THE GOD WHO SUSTAINS

- 12 Big Q & A 13 Song
- 13 Big Question 13 Song: Why Do God's People Keep Believing in Him?
- 14 Big Question 13 Bible Verse Song: Cast Your Burden on the LORD Psalm 55:22, ESV
- 15 Extra Big Question 13 Bible Verse Song: Cast Your Burden Psalm 55:22, ESV
- 16 Extra Big Question 13 Bible Verse Song: The LORD Your God Is with You Zephaniah 3:17, NIV 1984
- 17 Big Question 13 Hymn: Jesus Paid It All, v.1
- 18 Big Question 13 Praise Song: I Will Sing of the Mercies

Why Do God's People Keep Believing in Him? It is God's Sustaining Grace...

Bible Truth 1: God Alone Sustains His People

- 19 Bible Verse: To Him Who Is Able Jude 1:24-25, ESV
- 20 Extra Bible Verse: To Him, to Him Jude 1:24-25, ESV
- 21 Extra Bible Verse: Jude Doxology Jude 1:24-25, NIV1984

Bible Truth 2: God, the Father, Promises to Help His People

- 22 Bible Verse: Behold, God is My Helper: Psalm 54:4,7, ESV
- 23 Extra Bible Verse: Even to Your Old Age Isaiah 46:4,9,11, ESV
- 24 Extra Bible Verse: Though the Earth Give Way Psalm 46:1,2, ESV

Bible Truth 3: Jesus Provides God's People with Everything They Need

- 25 Bible Verse: Let Us with Confidence Hebrews 4:16, ESV
- 26 Extra Bible Verse: Let Us Then Draw Near Hebrews 4:16, ESV

Bible Truth 4: The Holy Spirit Works Inside of God's People

- 27 Bible Verse: It Is God Who Establishes Us with You 2 Corinthians 1:21-22, ESV
- 28 Extra Bible Verse: And It Is God 2 Corinthians 1:21-22, ESV
- 29 Extra Bible Verse: The Fruit of the Spirit Galatians 5:22,25, ESV
- 30 Extra Bible Verse: The Fruit Galatians 5:22,25, ESV
- 31 Extra Bible Verse: I Will Ask the Father John 14:16-17, ESV
- 32 Extra Bible Verse: I Will Give You a New Heart Ezekiel 36:26, ESV
- 33 Extra Bible Verse: You Shall Be Clean Ezekiel 36:25-27, ESV

Bible Truth 5: The Word of God Feeds God's People

- 34 Bible Verse: For Whatever Was Written Romans 15:4, ESV
- 35 Extra Bible Verse: He Humbled You Deuteronomy 8:3, ESV
- 36 Extra Bible Verse: Take Up the Whole Armor Ephesians 6:13,16-18, ESV

Bible Truth 6: God Uses His People to Strengthen and Comfort Each Other

- 37 Bible Verse: Blessed Be the God and Father 2 Corinthians 1:3-4, ESV
- 38 Extra Bible Verse: Praise be to the God and Father 2 Corinthians 1:3-4,10-13, NIV 1984
- 39 Extra Bible Verse: Help Us 2 Corinthians 1:13, ESV (other version)
- 40 Extra Bible Verse: Let Us Hold Fast the Confession Hebrews 10:23-25, ESV
- 41 Extra Bible Verse: Encourage One Another 1 Thessalonians 5:11-15, ESV
- 42 Extra Bible Verse: Build One Another Up 1 Thessalonians 5:11-15, ESV

DEEP DOWN DETECTIVES



Simple Story Scenes

Unit 13,

Bible Truth 1

Using Simple Story Scenes as a Curriculum

Introduce the Key Concept and Bible Verse

Simple Story Scenes give you the basics for the core of your lesson. You can use the overview sheet to introduce and explain the key concept and Bible verse.

Give the Case Assignment

Give the children a Detective Dan listening assignment. Two are provided. You can add a third using the ideas on the bonus, third take-home sheet, if desired. Each listening assignment, let's you teach the story with a different learning emphasis.

Show & Tell the Story

Hold up the pictures and tell the story from the story scenes. Alternatively, you can find in the and Pieces section for this unit at praisefactory.org, these same listening assignments and story scenes, gospel and ACTS prayer modified for view on a screen. Simply download them or open them online and show through your own monitor (tablet, big screen, whatever).

Solve the Case

Repeat Detective Dan's listening assignment question and discuss the answer.

Share the Gospel

Share the gospel tie-in with the kids.

Close in ACTS Prayer

Pray the ACTS prayer with the kids. If using the curriculum with older children, give them a chance to think up their own ACTS tie-ins to the story, using the one provided as cues/ideas for you.

Review Time

Give out the take-home sheet (there are three: two that correlates to the two Detective Dan assignments in the Story Scenes, and a bonus third one.) As the children are coloring, use the take-home sheet discussion questions or your own questions to further review and apply the key concepts, Bible verse, and story truths to the children.

Looking for more?

Online, in the Bits and Pieces section for this unit, you will find review games, crafts, storyboard flannelgraph figures, and audio and sheet music for all of the songs. There are also full lesson plans that offer more of a script and take this curriculum's possibilities to much more depth. Don't forget to tell the parents about the Parents Resources section where they can read through the Story scenes and download take homes with their kids.

Unit 13: The God Who Sustains

Unit Big Question (and Answer): Why Do God's People Keep Believing in Him? It Is God's Sustaining Grace!

Unit Bible Verse: "Cast your burden on the LORD, and he will sustain you; he will never permit the righteous to be moved." --Psalm 55:22, ESV

Bible Truth 1 Concept: It Is God's Sustaining Grace... God Alone Sustains His People

God is the Creator of all things, but He is also the Sustainer of all things. That means He's the one who alone keeps everything working according to His perfect purposes. That includes the stars and the planets, the rocks and the plants, the birds, the fish, the animals, and people. Absolutely everything!

God created people with something special inside their bodies: a spirit to know and love Him. We depend upon Him to sustain both our bodies and our spirits. He's the one who works in our heart to turn us away from our sins and trust in Jesus as our Savior. This is how we become God's people. He's the one who gives His people new hearts filled with the Holy Spirit so that they love Him and live for Him. He helps them to keep fighting sin inside their hearts and to faithfully endure the sufferings they face.

Without God's sustaining power, God's people know they would never be able to know God or keep on following Him. They depend upon Him to sustain their love and obedience to Him all the days of their lives. They are so grateful that they don't have to depend upon themselves but have His unfailing promise to help them do this. We can become God's people when we turn away from our sins and trust in Jesus as our Savior.

Bible Truth 1 Bible Verse: Jude 1:24-25, ESV

"Now to him who is able to keep you from stumbling and to present you blameless before the presence of his glory with great joy, to the only God, our Savior, through Jesus Christ our Lord, be glory, majesty, dominion, and authority, before all time and now and forever. Amen."

Learn a Little "Now to [God] who is able to keep you and to present you blameless be glory forever. Amen."

Meaning

We stumble when we trip over a rock or our shoelaces. We have to catch ourselves before we fall down and get hurt. This is how our bodies stumble. But did you know we can stumble inside our heart, too? Our heart stumbles when we are tempted to stop trusting in God or obeying His Word. The sin in our heart makes it easy to stumble.

God's people don't want to stumble in their hearts. They don't want sin to keep them from loving God and living for Him. They know they can't keep themselves from stumbling, but they know that God can. He promises to help them. He promises that all their sins are forgiven through Jesus. He promises to keep on sustaining their love for Him their whole lives. They know that because of God's promise to sustain them, that one day they will come into their His presence and praise His name forever. God was the one who took away their sins. He was the one who helped them every day of their lives! And they will go on praising Him and thanking Him forever. We can become God's people when we turn away from our sins and trust in Jesus as our Savior.

Bible Truth 1 ACTS Prayer

- A** God, we praise You for being the Sustainer of all things. You keep everything going according to Your perfect plans.
- C** We confess that many times we doubt that You really will sustain us through hard times. We act like You won't be faithful to us. We need a Savior!
- T** God, thank You for Your promises to always sustain Your people, so that they will keep loving and obeying You all their lives.
- S** God, please sustain us. Work in our hearts. Help us to turn away from our sins and trust in Jesus as our Savior. Help us to know You. Give us what we need each day to love You and live for You. In Jesus' name we pray, Amen.

Bible Truth 1 Story**The Case of the Impossible, Big, Bad, Scary News**

Genesis 37:12-36; 39-50; Exodus 1-15

Songs Used in Bible Truth 1

Big Q & A 13 Song

Big Question 13 Song: Why Do God's People Keep Believing in Him?

Big Question 13 Bible Verse Song: Cast Your Burden on the LORD Psalm 55:22, ESV

Extra Big Question 13 Bible Verse Song: Cast Your Burden Psalm 55:22, ESV (other version)

Extra Big Question 13 Bible Verse Song: The LORD Your God Is with You Zephaniah 3:17, NIV 1984

Big Question 13 Hymn: Jesus Paid It All, v.1

Big Question 13 Praise Song: I Will Sing of the Mercies

Bible Truth 1 Bible Verse: To Him Who Is Able Jude 1:24-25, ESV

Bible Truth 1 Extra Bible Verse: To Him, to Him Jude 1:24-25, ESV

Bible Truth 1 Extra Bible Verse: Jude Doxology Jude 1:24-25, NIV1984

listen to or download songs for free at <https://praisefactory.org>: Deep Down Detectives Music page

“The Case of the Impossible, Big, Bad, Scary News” Genesis 37:12-36; 39-50; Exodus 1-15



Detective Dan's Listening Assignment #1

1. What was the impossible, big, bad, SCARY news?
2. Who turned this bad news into amazing, good news each time?

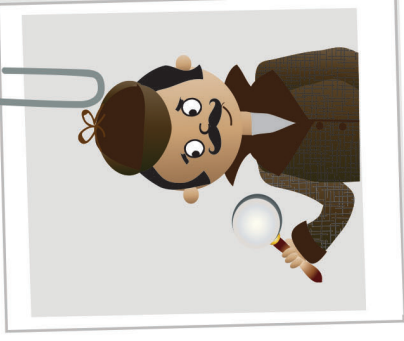

Detective Dan's Listening Assignment #2

Jude 1:24, 25, ESV

“Now to [God] who is able to keep you and to present you blameless be glory forever. Amen.”

1. Who helped the people of Israel when they stumbled in their faith, fearing Pharaoh and his soldiers?
2. How did He help them?

(more listening and discussion questions are included in the curriculum at praisefactory.org)

I. Badd news, badd news! There was badd news in Canaan for Jacob's family! No rain fell from the sky. The rivers dried up. Their animals and crops were dying.

If they didn't find food and water soon, they would die, too. What could they do? Where could they go? They needed help. Big help!



I. Bad news, bad news! There was bad news in Canaan for Jacob's family! No rain fell from the sky. The rivers dried up. Their animals and crops were dying. If they didn't find food and water soon, they would die, too. What could they do? Where could they go? They needed help. Big help!

2. This may have been impossible, big, bad, SCARY news, but Jacob's family didn't need to be afraid. They might not see any way out, but that didn't matter. The LORD was their God. He had made them His people. And if there's one thing the LORD promises to do for His people, it's to take care of them.

He will always save and sustain them. He will take care of their needs and grow their trust in Him. He will help them keep on believing in Him and living for Him. And He didn't even need anyone's help to do it.

The LORD can even take impossible, big, bad, SCARY news and make it into amazing, good news, and sure enough, that's just what He was about to do!



2. This may have been impossible, big, bad, SCARY news, but Jacob's family didn't need to be afraid. They might not see any way out, but that didn't matter. The LORD was their God. He had made them His people. And if there's one thing the LORD promises to do for His people, it's to take care of them. He will always save and sustain them. He will take care of their needs and grow their trust in Him. He will help them keep on believing in Him and living for Him. And He didn't even need anyone's help to do it. The LORD can even take impossible, big, bad, SCARY news and make it into amazing, good news, and sure enough, that's just what He was about to do!

3. Good news! Good news! There was food in nearby Egypt! And WHO had been put in charge of giving out the food? Joseph, one of Jacob's sons!

God had planned for Joseph to be in Egypt ahead of time, so everything would be ready for Jacob's family when the food and water ran out in Canaan.



3. Good news! Good news! There was food in nearby Egypt! And WHO had been put in charge of giving out the food? Joseph, one of Jacob's sons! God had planned for Joseph to be in Egypt ahead of time, so everything would be ready for Jacob's family when the food and water ran out in Canaan.

4. So, Jacob gathered up his family, packed his things, and went to live in Egypt.

Joseph picked a beautiful place near the River Nile for Jacob's family to live. Pharaoh, the king of Egypt, himself, welcomed Jacob to his land and made sure Jacob and his family had everything they needed.



4. So, Jacob gathered up his family, packed his things, and went to live in Egypt. Joseph picked a beautiful place near the River Nile for Jacob's family to live. Pharaoh, the king of Egypt, himself, welcomed Jacob to his land and made sure Jacob and his family had everything they needed.

5. Jacob praised God for taking care of them. How good it was to be with Joseph again! How good it was to have plenty of food and water! How good it was to have a beautiful place to live!

God had taken their impossible, bad news and turned it into amazing, good news. He always sustains His people. He gave them faith for their hearts and food for their bodies. God, alone, had provided.



5. Jacob praised God for taking care of them. How good it was to be with Joseph again! How good it was to have plenty of food and water! How good it was to have a beautiful place to live! God had taken their impossible, bad news and turned it into amazing, good news. He always sustains His people. He gave them faith for their hearts and food for their bodies. God, alone, had provided.

6. Life was happy in Egypt for quite some time. Instead of going home to Canaan when the drought was over, Jacob's family decided to stay in Egypt.

Many years passed. Jacob's family grew and grew. They had come from Canaan as just a little family.

Now, there were hundreds and thousands of them! No one called them Jacob's "family" anymore. Now, they were called a "people": the people of Israel. (Israel was a special name God gave Jacob).



6. Life was happy in Egypt for quite some time. Instead of going home to Canaan when the drought was over, Jacob's family decided to stay in Egypt. Many years passed. Jacob's family grew and grew. They had come from Canaan as just a little family. Now, there were hundreds and thousands of them! No one called them Jacob's "family" anymore. Now, they were called a "people": the people of Israel. (Israel was a special name God gave Jacob).

7. The people of Egypt saw how big Jacob's family had grown and they were worried.

Joseph and Jacob were long gone and forgotten. So was the pharaoh who was good to his family.

A new Pharaoh was king now. He had big plans to make big buildings. It would take a lot of people to build them, and he knew just who to use –the people of Israel.

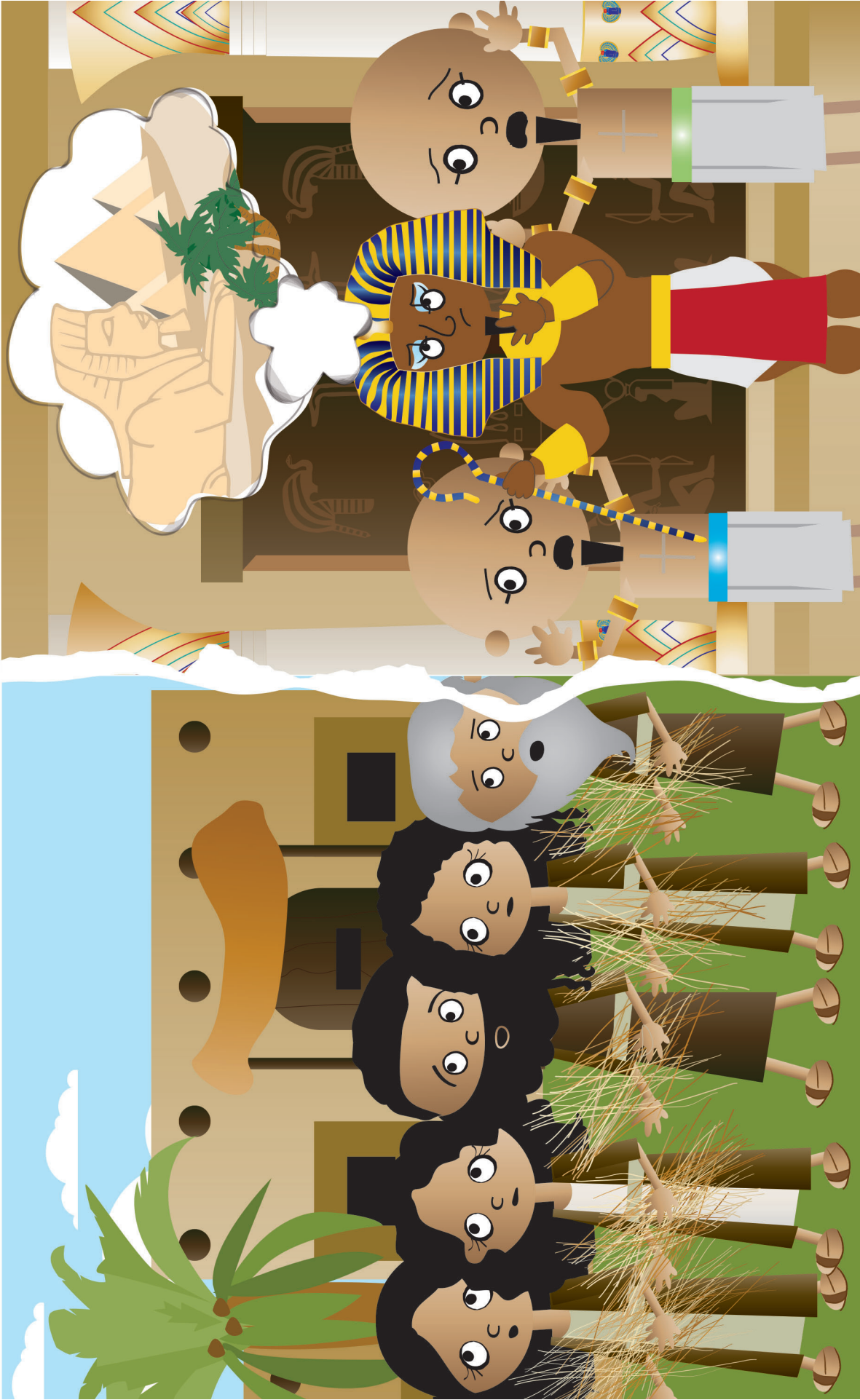

7. The people of Egypt saw how big Jacob's family had grown and they were worried. Joseph and Jacob were long gone and forgotten. So was the Pharaoh who was good to his family. A new Pharaoh was king now. He had big plans to make big buildings. It would take a lot of people to build them, and he knew just who to use –the people of Israel.

8. Badd news, badd news! The new king didn't ASK the people of Israel to help build his new buildings. He MADE them do it!

He took over their lives. He said he owned them and could make them do whatever he wanted them to do. He FORCED them to build his buildings. He made them work so hard and without any pay at all. He treated them so badly! Life in Egypt wasn't good for the people of Israel anymore.

Oh, how they wanted to go home to Canaan, but how could they? The king would never let them go. This was badd news! Impossible, big, badd, SCARY news!

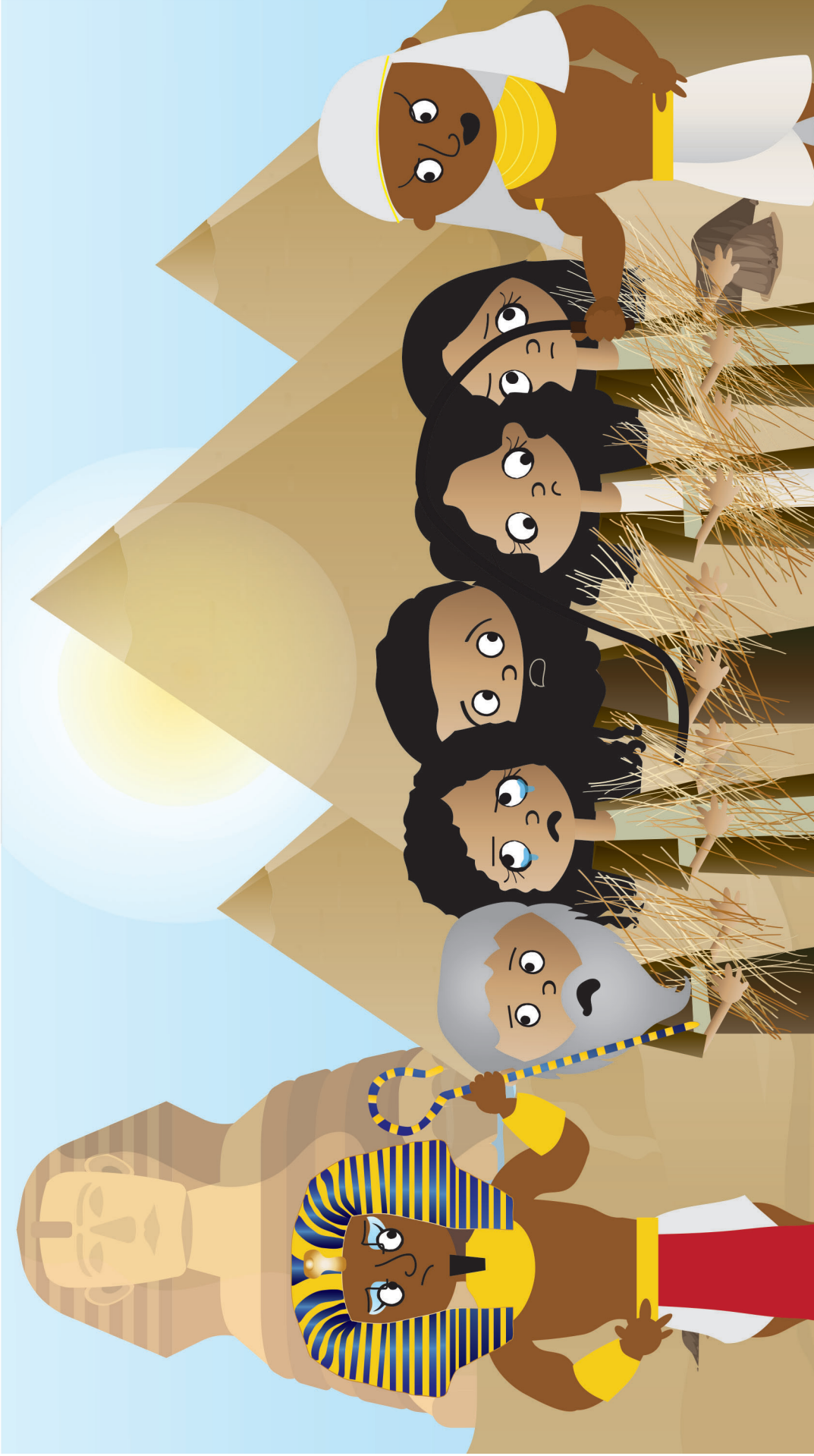

8. Bad news, bad news! The new king didn't ASK the people of Israel to help build his new buildings. He MADE them do it! He took over their lives. He said he owned them and could make them do whatever he wanted them to do. He FORCED them to build his buildings. He made them work so hard and without any pay at all. He treated them so badly! Life in Egypt wasn't good for the people of Israel anymore. Oh, how they wanted to go home to Canaan, but how could they? The king would never let them go. This was bad news! Impossible, big, bad, SCARY news!

q. But the people of Israel didn't need to be afraid. They might not see any way out, but that didn't matter. The LORD was their God. He had made them His people. And if there's one thing the LORD promises to do for His people, it's to take care of them.

He will always save and sustain them. He will take care of their needs and grow their trust in Him. He will help them keep on believing in Him and living for Him. And He didn't even need anyone's help to do it.

The LORD can even take impossible, big, bad, SCARY news and make it into amazing, good news, and sure enough, that's just what He was about to do!



9. But the people of Israel didn't need to be afraid. They might not see any way out, but that didn't matter. The LORD was their God. He had made them His people. And if there's one thing the LORD promises to do for His people, it's to take care of them. He will always save and sustain them. He will take care of their needs and grow their trust in Him. He will help them keep on believing in Him and living for Him. And He didn't even need anyone's help to do it. The LORD can even take impossible, big, bad, SCARY news and make it into amazing, good news, and sure enough, that's just what He was about to do!

10. Good news! Good news! The LORD sent Moses and Aaron to speak to Pharaoh.

“The LORD says, ‘Let my people go!’ they demanded. What would the king do? Would he let the people of Israel go free?

“No, the people can’t go,” the king said, at first. But the LORD wasn’t finished.



10. Good news! Good news! The LORD sent Moses and Aaron to speak to Pharaoh. “The LORD says, ‘Let My people go!’ they demanded. What would the king do? Would he let the people of Israel go free? “No, the people can’t go,” the king said, at first. But the LORD wasn’t finished.

II. The LORD sent frogs and gnats and hail and sicknesses and many other sadnesses upon the king and his people.

And then, he changed his mind.

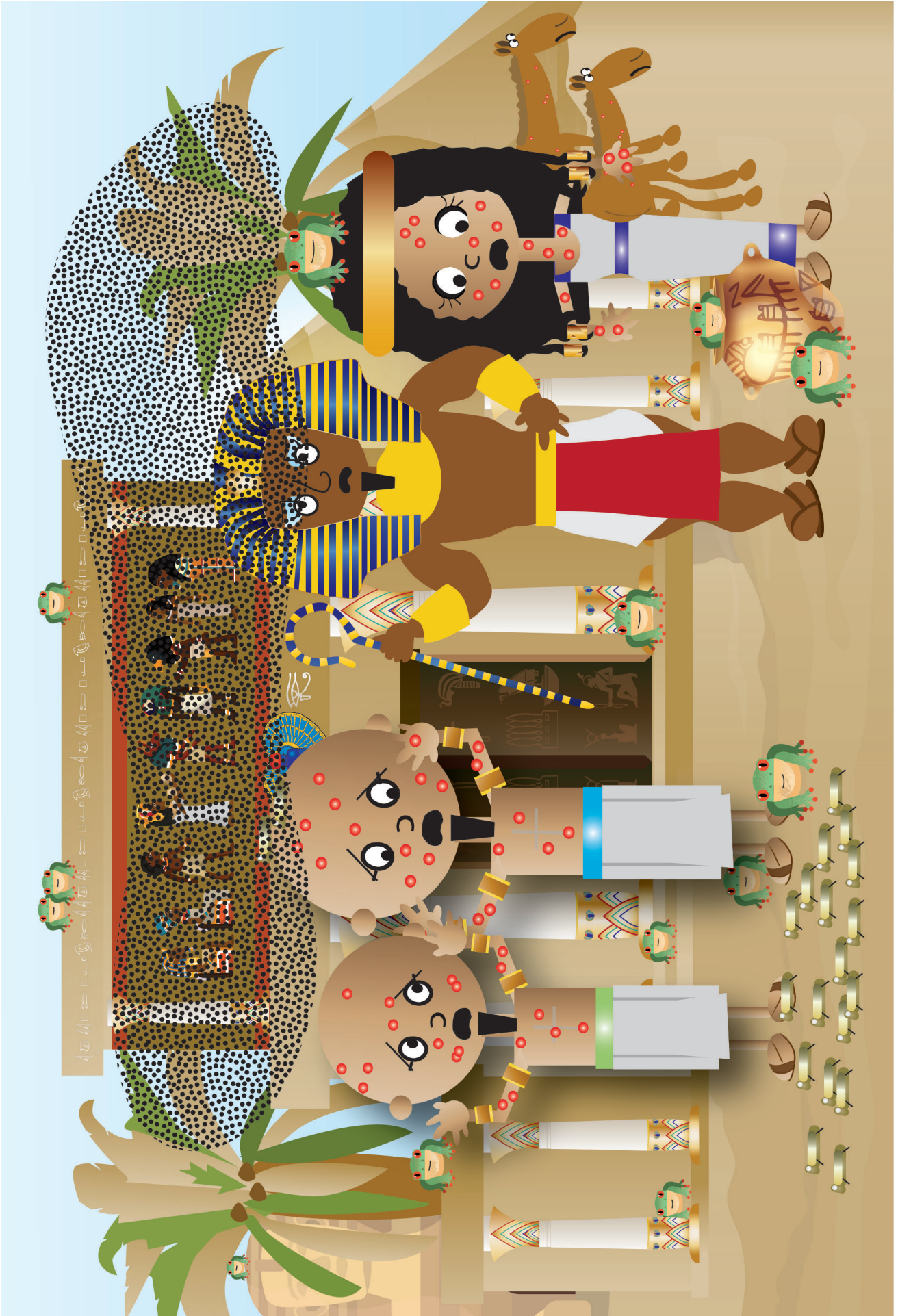

II. The LORD sent frogs and gnats and hail and sicknesses and many other sadnesses upon the king and his people. And then, he changed his mind.

12. “Go away! Leave us alone,” Pharaoh ordered. “The people of Israel are free to go. Make your God stop sending sadnesses upon us!” he told Moses.

“Hooray, hooray! Praise the LORD!” Moses and the people shouted. They packed their things, gathered their families, and marched out of Egypt.



12. "Go away! Leave us alone," Pharaoh ordered. "The people of Israel are free to go. Make your God stop sending sadnesses upon us!" he told Moses. "Hooray, hooray! Praise the LORD!" Moses and the people shouted. They packed their things, gathered their families, and marched out of Egypt.

**13. Across the desert, Moses led the people, “Tromp, tromp, tromp.”
They camped along the shores of the Red Sea.**

How good it was to be free! How good it was to be going home!

**The LORD had taken their impossible, big, bad, SCARY news and
made it into amazing, good news. He always sustains His people. He,
alone!**



13. Across the desert, Moses led the people, “Tromp, tromp, tromp.” They camped along the shores of the Red Sea. How good it was to be free! How good it was to be going home! The LORD had taken their impossible, big, bad, SCARY news and made it into amazing, good news. He always sustains His people. He, alone!

14. But what was that noise in the middle of the night?

It was the sound of hundreds of rolling wheels, hundreds of horses neighing, and hundreds of soldiers shouting.

Oh, no! It was Pharaoh's army!

The king had changed his mind. He wanted his slaves back. He ordered an army of soldiers on chariots to capture them and bring them back to Egypt!



14. But what was that noise in the middle of the night? It was the sound of hundreds of rolling wheels, hundreds of horses neighing, and hundreds of soldiers shouting. Oh, no! It was Pharaoh's army! The king had changed his mind. He wanted his slaves back. He ordered an army of soldiers on chariots to capture them and bring them back to Egypt!

15. Bad news bad news! The word spread through the camp. “The pharaoh’s soldiers are coming!

“Oh no! Where could they go? How could they escape?”

The Red Sea was on one side and the soldiers were on the other. They were stuck!



15. Bad news bad news! The word spread through the camp. "The Pharaoh's soldiers are coming! "Oh no! Where could they go? How could they escape? The Red Sea was on one side and the soldiers were on the other. They were stuck!

16. But the people of Israel didn't need to be afraid! They might not see any way out, but that didn't matter. The LORD was their God. He had made them His people.

And if there's one thing the LORD promises to do for His people, it's to take care of them. He will always save and sustain them. He will take care of their needs and grow their trust in Him.

He will help them keep on believing in Him and living for Him. And He didn't even need anyone's help to do it. The LORD can even take impossible, big, bad, SCARY news and make it into amazing, good news, and sure enough, that's just what He was about to do!



16. But the people of Israel didn't need to be afraid! They might not see any way out, but that didn't matter. The LORD was their God. He had made them His people. And if there's one thing the LORD promises to do for His people, it's to take care of them. He will always save and sustain them. He will take care of their needs and grow their trust in Him. He will help them keep on believing in Him and living for Him. And He didn't even need anyone's help to do it. The LORD can even take impossible, big, bad, SCARY news and make it into amazing, good news, and sure enough, that's just what He was about to do!

**17. “Don’t be afraid. Stand firm and you will see the LORD rescue you,”
Moses told the people. “The LORD will fight for you; you need only to
be still and watch.”**



17. "Don't be afraid. Stand firm and you will see the LORD rescue you," Moses told the people. "The LORD will fight for you; you need only to be still and watch."

18. Then, at the LORD's command, Moses raised up his shepherd's staff and stretched it out towards the Red Sea.

“Whoosh,” the LORD sent a strong, east wind. It blew and blew and blew on the water of the Red Sea. And as it blew, something amazing happened.

Can you guess what it was?



18. Then, at the LORD's command, Moses raised up his shepherd's staff and stretched it out towards the Red Sea. "Whoosh," the LORD sent a strong, east wind. It blew and blew and blew on the water of the Red Sea. And as it blew, something amazing happened. Can you guess what it was?

19. Good news! Good news! The people watched the wind split apart the waters of the sea, making two, huge, watery walls.

Taller and taller the walls grew, and in between them, the seabed dried up into a sandy path. The LORD had made a way of escape for His people, and they took it.

How amazing it must have been to cross through the Red Sea between those big walls of water!

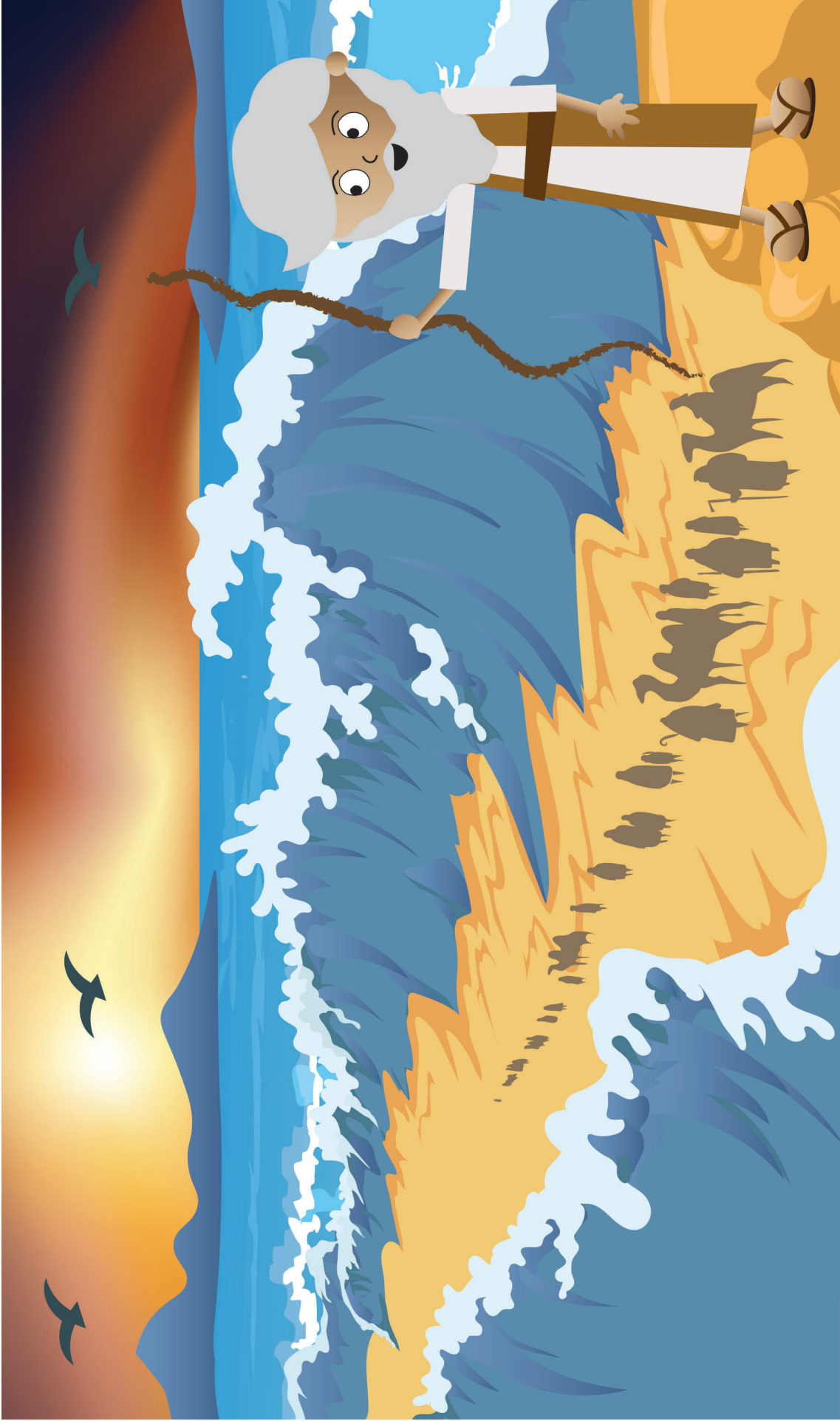

19. Good news! Good news! The people watched the wind split apart the waters of the sea, making two, huge, watery walls. Taller and taller the walls grew, and in between them, the seabed dried up into a sandy path. The LORD had made a way of escape for His people, and they took it. How amazing it must have been to cross through the Red Sea between those big walls of water!

20. Pharaoh's soldiers saw what the LORD had done. They watched the people of Israel escape through the middle of the sea on dry land.

What would they do now? Would they fear the mighty God who had done this amazing thing and stop chasing His people? Or, would they reject Him and keep going after them?



20. Pharaoh's soldiers saw what the LORD had done. They watched the people of Israel escape through the middle of the sea on dry land. What would they do now? Would they fear the mighty God who had done this amazing thing and stop chasing His people? Or, would they reject Him and keep going after them?

21. The soldiers did NOT fear the LORD; and they most certainly DID follow!

Across the sandy beach and onto the dry path between those great, watery walls, those soldiers rode their chariots. But it was no use! The LORD had made that path for His people, not for their enemies.

As the sun rose in the east, and the last of God's people had crossed safely to the far side of the sea, the LORD ordered the waves back in place. Pharaoh's soldiers on their chariots were all swept away.



21. The soldiers did **NOT** fear the LORD; and they most certainly **DID** follow! Across the sandy beach and onto the dry path between those great, watery walls, those soldiers rode their chariots. But it was no use! The LORD had made that path for His people, **not** for their enemies. As the sun rose in the east, and the last of God's people had crossed safely to the far side of the sea, the LORD ordered the waves back in place. Pharaoh's soldiers on their chariots were all swept away.

22. On the banks of the Red Sea that morning, Moses and Miriam and all the people of Israel sang their praises to the LORD: “I will sing to the LORD! He is my strength and my Savior. He is my God and I will praise him! He has gotten rid of our enemies. He swept them away in the sea. His love for His people will never fail. He rules over everything forever and ever.”

And they were right! The LORD was the one, true God. He would always be with His people and always help them. He would take care of their needs. They could always trust Him.

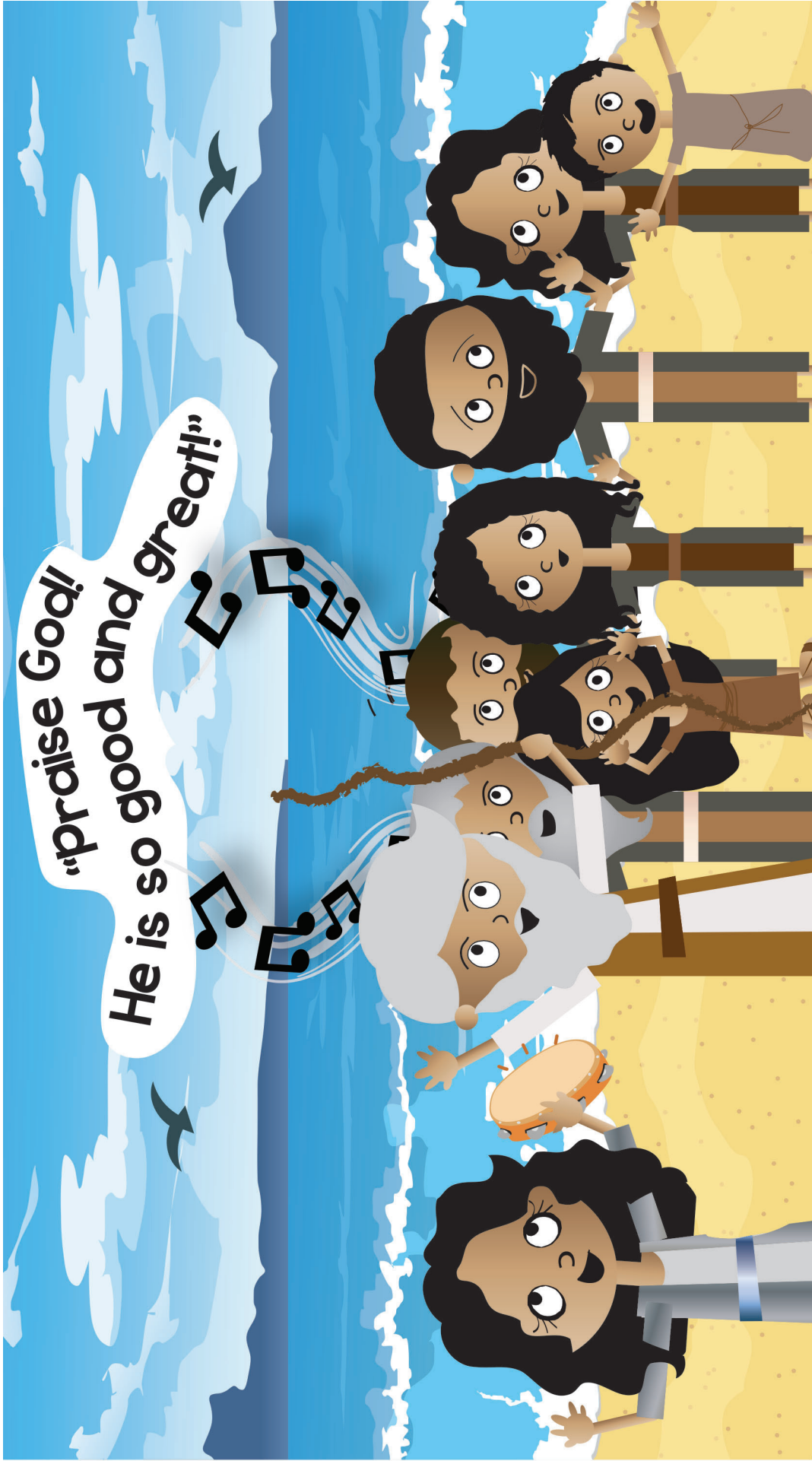

22. On the banks of the Red Sea that morning, Moses and Miriam and all the people of Israel sang their praises to the LORD: "I will sing to the LORD! He is my strength and my Savior. He is my God and I will praise him! He has gotten rid of our enemies. He swept them away in the sea. His love for His people will never fail. He rules over everything forever and ever." And they were right! The LORD was the one, true God. He would always be with His people and always help them. He would take care of their needs. They could always trust Him.

23. It would be many more years before the people of Israel were to make it all the way back home to Canaan. They were to face many more “bad news” days.

But no matter what the impossible, big, bad, SCARY news was, can you guess what the LORD always did for His people?

The LORD always took care of them and gave them amazing, good news. He always saved them and sustained them. He took care of their needs and grew their trust in Him. He helped them keep on believing in Him and living for Him. And He didn't even need anyone's help to do it!

Yes, the LORD always sustained them and got them all the way home! The LORD, and the LORD alone.

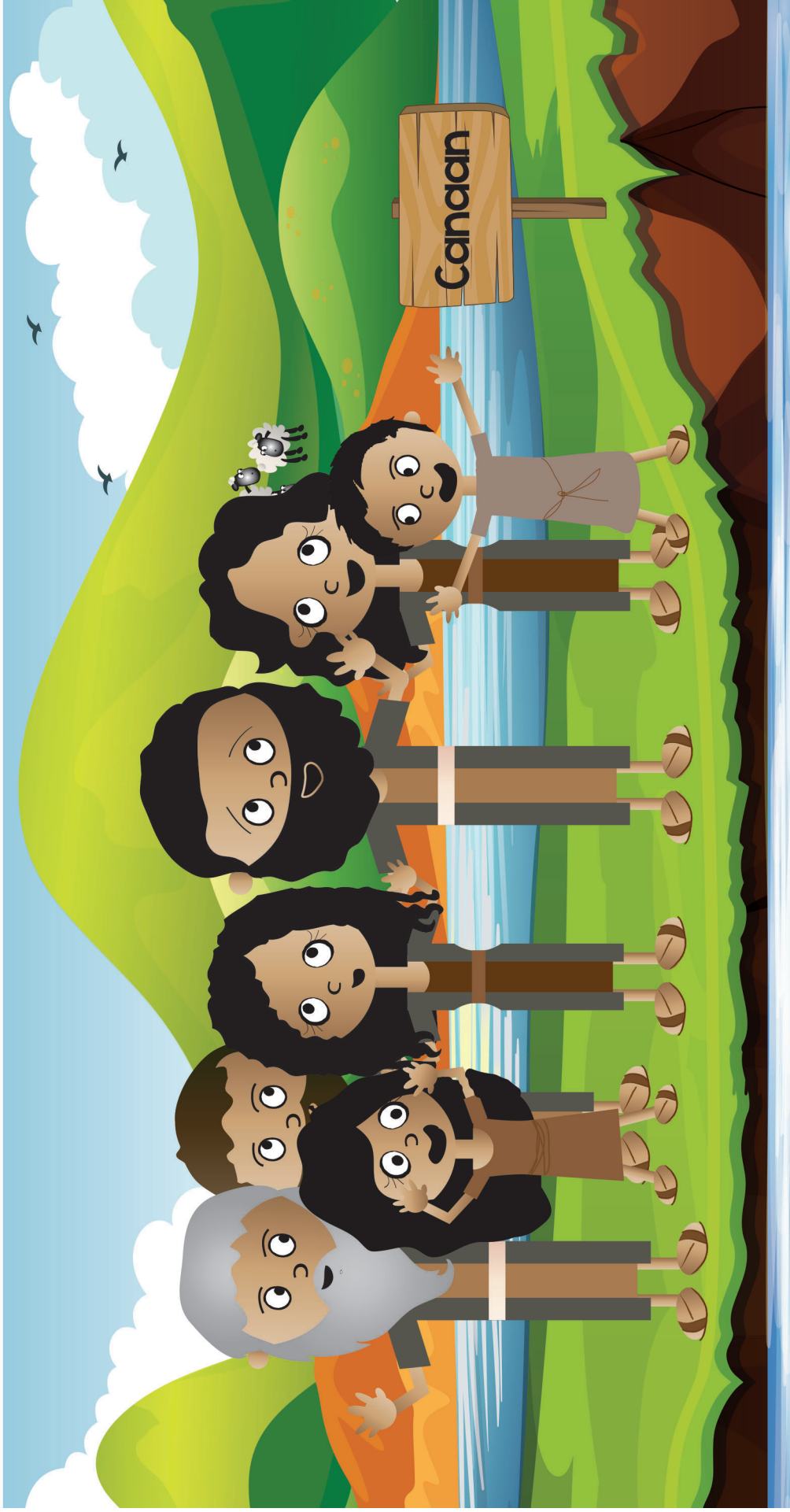

23. It would be many more years before the people of Israel were to make it all the way back home to Canaan. They were to face many more “bad news” days. But no matter what the impossible, big, bad, SCARY news was, can you guess what the LORD always did for His people? The LORD always took care of them and gave them amazing, good news. He always saved them and sustained them. He took care of their needs and grew their trust in Him. He helped them keep on believing in Him and living for Him. And He didn’t even need anyone’s help to do it! Yes, the LORD always sustained them and got them all the way home! The LORD, and the LORD alone.

DDD 13.1 Simple Story Scenes

SOLVED

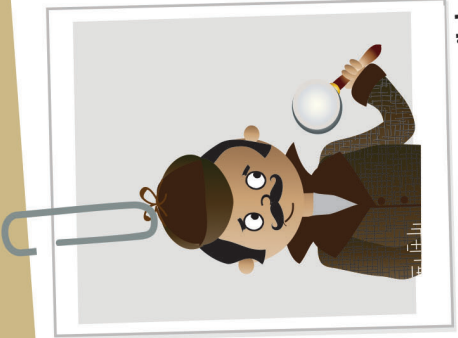

Detective Dan's Listening Assignment #1

1. What was the impossible, big, bad, SCARY news? Jacob and the people of Israel faced many problems that were too big for them: no food to eat because there was no rain; then, no way to get free from the mighty Pharaoh and his soldiers.
2. Who turned this bad news into amazing, good news each time? The LORD did! He always helped His people and took care of their needs. They could always trust in Him.

For You and Me:
There may be times in our lives when we get impossible, big, bad, SCARY news. There may be times when there seems to be no way out of trouble. But with the LORD, there is always a way out. He always is at work, helping His people. He always will give them what they need. He will always help them to keep on loving Him and living for Him. We can be God's people, too, when we turn away from our sins and trust in Jesus as our Savior. Then, we can know that the LORD will always sustain us. He will always give us what we need. He will always help us to keep on loving Him and living for Him. Thank You, God! Help us to trust in You today!

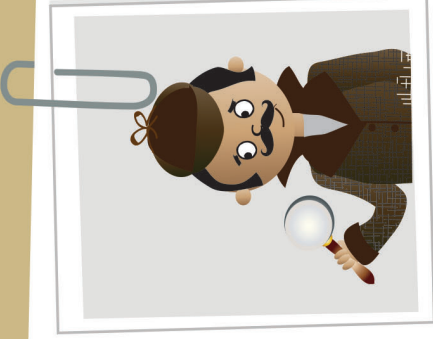

Detective Dan's Listening Assignment #2

Jude 1:24, 25, ESV

“Now to [God] who is able to keep you and to present you blameless be glory forever. Amen.”

1. Who helped the people of Israel when they stumbled in their faith, fearing Pharaoh and his soldiers? The LORD did!
2. How did He help them? He took care of their needs and rescued them. He gave them faith to trust Him and obey Him, even though they were afraid.

For You and Me:
There may be times in our lives when we get impossible, big, bad, SCARY news. There may be times when there seems to be no way out of trouble. But with the LORD, there is always a way out. He always is at work, helping His people. He always will give them what they need. He will always help them to keep on loving Him and living for Him. We can be God's people, too, when we turn away from our sins and trust in Jesus as our Savior. Then, we can know that the LORD will always sustain us. He will always give us what we need. He will always help us to keep on loving Him and living for Him. Thank You, God! Help us to trust in You today!

DDD 13.1 Simple Story Scenes

Why Do God's People Keep Believing in Him?
It Is God's Sustaining Grace...
God Alone Sustains His People!

The Gospel



Oh, how we need God to help us to keep believing in Him! We are all sinners who have chosen to disobey God. The beautiful heart that God put inside of us to know and love Him is broken.

That's why God sent His Son, Jesus. Jesus lived a perfect life, then He offered it up as the full payment for the sins of God's people when He died on the cross. Jesus didn't stay dead! On Day Three, He rose from the dead in victory. He had really beaten sin and death for God's people.

Now, all who turn away from their sins and trust in Jesus as their Savior can be God's people. God forgives their sins and puts His Holy Spirit in their hearts.

He gives them new hearts that know Him and want to love Him. This is how we can become God's people, too. And the wonderful news is that all who do become God's people will always be God's people! He will keep on helping them to love Him and live for Him the rest of their lives.

Thank You, LORD!



DDD 13.1 Simple Story Scenes

A Prayer

A God, we praise You for being the Sustainer of all things. You keep everything going according to Your perfect plans.

C We confess that many times we doubt that You really will sustain us through hard times. We act like You won't be faithful to us. We need a Savior!

T God, thank You for Your promises to always sustain Your people, so that they will keep loving and obeying You all their lives.

S God, please sustain us. Work in our hearts. Help us to turn away from our sins and trust in Jesus as our Savior. Help us to know You. Each day, give us what we need to love You and live for You.

In Jesus' name we pray. Amen.



DDD 13.1 Simple Story Scenes

DEEP DOWN DETECTIVES



Simple Story Scenes

Unit 13,

Bible Truth 2

Using Simple Story Scenes as a Curriculum

Introduce the Key Concept and Bible Verse

Simple Story Scenes give you the basics for the core of your lesson. You can use the overview sheet to introduce and explain the key concept and Bible verse.

Give the Case Assignment

Give the children a Detective Dan listening assignment. Two are provided. You can add a third using the ideas on the bonus, third take-home sheet, if desired. Each listening assignment, let's you teach the story with a different learning emphasis.

Show & Tell the Story

Hold up the pictures and tell the story from the story scenes. Alternatively, you can find in the and Pieces section for this unit at praisefactory.org, these same listening assignments and story scenes, gospel and ACTS prayer modified for view on a screen. Simply download them or open them online and show through your own monitor (tablet, big screen, whatever).

Solve the Case

Repeat Detective Dan's listening assignment question and discuss the answer.

Share the Gospel

Share the gospel tie-in with the kids.

Close in ACTS Prayer

Pray the ACTS prayer with the kids. If using the curriculum with older children, give them a chance to think up their own ACTS tie-ins to the story, using the one provided as cues/ideas for you.

Review Time

Give out the take-home sheet (there are three: two that correlates to the two Detective Dan assignments in the Story Scenes, and a bonus third one.) As the children are coloring, use the take-home sheet discussion questions or your own questions to further review and apply the key concepts, Bible verse, and story truths to the children.

Looking for more?

Online, in the Bits and Pieces section for this unit, you will find review games, crafts, storyboard flannelgraph figures, and audio and sheet music for all of the songs. There are also full lesson plans that offer more of a script and take this curriculum's possibilities to much more depth. Don't forget to tell the parents about the Parents Resources section where they can read through the Story scenes and download take homes with their kids.

Unit 13: The God Who Sustains

Unit Big Question (and Answer): Why Do God's People Keep Believing in Him? It Is God's Sustaining Grace!

Unit Bible Verse: "Cast your burden on the LORD, and he will sustain you; he will never permit the righteous to be moved." --Psalm 55:22

Bible Truth 2 Concept: It Is God's Sustaining Grace... God, the Father, Promises to Help His People

God is a good Father to His people --to all who turn from their sins and trust in Jesus as their Savior. He knows that they can't love Him or live for Him by themselves. He knows they need His help, and He promises to give it to them.

He promises to take care of all their needs. He promises to comfort them when they are scared. He promises to help them fight against sin in their lives and rescue them in times of trouble. He promises to make everything in their lives work for their good and His glory. He sent Jesus to take the punishment for their sins on the cross to break the strong hold that sin and death had on them. He promises to send the Holy Spirit to work in their hearts. There is nothing that God's people need that their Heavenly Father will not provide. He will help them do everything He wants them to do, every day of their lives. We can become God's people when we turn away from our sins and trust in Jesus as our Savior.

Bible Truth 2 Bible Verse: Psalm 54:4,6-7, ESV

"Behold, God is my helper; the Lord is the upholder of my life...I will give thanks to your name, O Lord, for it is good. For he has delivered me from every trouble, and my eye has looked in triumph on my enemies."

Learn a Little "The Lord is the upholder of my life."

Meaning

God promises to help His people. He promises to uphold their life, so that they keep on loving Him and living for Him. God has a good plan for each one of His people. He may call them to do some things that are very hard, but He will deliver them out of all their troubles. He promises to give them the strength they need to go through them. He promises to use every trouble for their good. And at just the right time, He will bring their troubles to an end. God's people know they can depend on Him to help them whenever they need help, and to go on helping them for the rest of their lives. He is their sustainer! We can become God's people, too, when we turn away from our sins and trust in Jesus as our Savior.

Bible Truth 2 ACTS Prayer

- A** God, we praise You for being faithful to help Your people live for You.
- C** We confess that many times we choose not to trust Your promises to help us. We would rather do things our own way or just depend on ourselves. We need a Savior!
- T** God, thank You for sending Jesus to break the power of sin and death. Thank You for Your promises to always help Your people.
- S** Please work in our hearts. Help us to turn away from our sins and trust in Jesus as our Savior. Help us to ask You for help and depend upon You. Help us to love You and live for You every day of our lives.

In Jesus' name we pray, Amen.

Bible Truth 2 Story

The Case of the Really Bad Remember-ers

Exodus 5-15, 19-20, 24; Numbers 13-14; Joshua 1-5

Songs Used in Bible Truth 2

Big Q & A 13 Song

Big Question 13 Song: Why Do God's People Keep Believing in Him?

Big Question 13 Bible Verse Song: Cast Your Burden on the LORD Psalm 55:22, ESV

Extra Big Question 13 Bible Verse Song: Cast Your Burden Psalm 55:22, ESV (other version)

Extra Big Question 13 Bible Verse Song: The LORD Your God Is with You Zephaniah 3:17, NIV 1984

Big Question 13 Hymn: Jesus Paid It All, v.1

Big Question 13 Praise Song: I Will Sing of the Mercies

Bible Truth 2 Bible Verse Song: Behold, God is My Helper Psalm 54:4,7, ESV

Bible Truth 2 Extra Bible Verse Song: Even to Your Old Age Isaiah 46:4,9,11, ESV

Bible Truth 2 Extra Bible Verse Song: Though the Earth Give Way Psalm 46:1,2, ESV

listen to or download songs for free at <https://praisefactory.org>: Deep Down Detectives Music page

“The Case of the Really Bad Remember-ers” Exodus 5-15, 19-20, 24; Numbers 13-14; Joshua 1-5

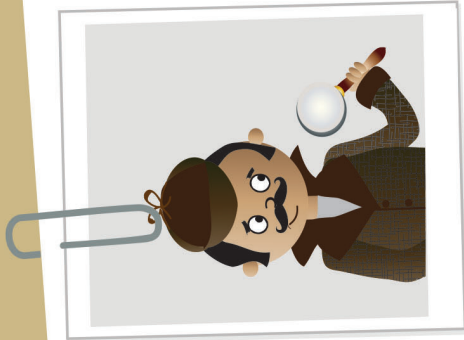

Detective Dan's Listening Assignment #1

1. Who were the really bad remember-ers? What did they refuse to remember about God?
2. What happened when they remembered God's promises?

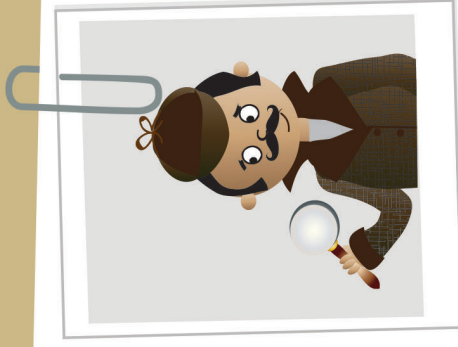

Detective Dan's Listening Assignment #2

Psalms 54:4, 6-7, ESV

“Behold, God is my helper; the Lord is the upholder of my life...I will give thanks to your name, O Lord, for it is good. For he has delivered me from every trouble, and my eye has looked in triumph on my enemies.”

1. What troubles did the people of Israel face?
2. What did the LORD promise to do for them in their troubles?

(more listening and discussion questions are included in the curriculum at praisefactory.org)

I. "It's time to go into Canaan, the land the LORD promised you!" Moses told the people of Israel.

This was the moment they had been waiting for! The LORD had rescued them from their enemies in Egypt. He had given them His laws and made them His people at Mt. Sinai. And now, He had led them to Kadesh Barnea, an oasis right next to Canaan.

"Canaan is filled with good things for you. Go in and take it, just as the LORD told you to," Moses told the people. "Don't be afraid. Don't be discouraged. The LORD is with you!" Moses urged them.



1. "It's time to go into Canaan, the land the LORD promised you!" Moses told the people of Israel. This was the moment they had been waiting for! The LORD had rescued them from their enemies in Egypt. He had given them His laws and made them His people at Mt. Sinai. And now, He had led them to Kadesh Barnea, an oasis right next to Canaan. "Canaan is filled with good things for you. Go in and take it, just as the LORD told you to," Moses told the people. "Don't be afraid. Don't be discouraged. The LORD is with you!" Moses urged them.

2. But the people weren't so sure. Maybe the LORD knew Canaan, but they didn't. Maybe there were some very good places to live and some very good food to eat in this land the LORD promised them. Perhaps it did flow with milk and honey (a nickname for a land filled with the best things).

But, there might be some very big enemies living there, too. Maybe enemies as big and bad as the armies of Egypt.

Hmmmm... "Let's send some men ahead of us to check out the land. Let them spy it out, then come back and report what they find," they said to Moses.



2. But the people weren't so sure. Maybe the LORD knew Canaan, but they didn't. Maybe there were some very good places to live and some very good food to eat in this land the LORD promised them. Perhaps it did flow with milk and honey (a nickname for a land filled with the best things). But, there might be some very big enemies living there, too. Maybe enemies as big and bad as the armies of Egypt. Hmmmm... "Let's send some men ahead of us to check out the land. Let them spy it out, then come back and report what they find," they said to Moses.

3. Did the people of Israel REALLY need to send out spies? Did they REALLY need to know if there were enemies and how big they were?

No, they didn't! The LORD was with them. No enemy would ever be too powerful for Him. It was His plan for them to have this land and no one can ever stop His plans.

The LORD would give them all the help they needed, no matter what enemy they faced. All they had to do was think back and remember.

THE LORD

3. Did the people of Israel REALLY need to send out spies? Did they REALLY need to know if there were enemies and how big they were? No, they didn't! The LORD was with them. No enemy would ever be too powerful for Him. It was His plan for them to have this land and no one can ever stop His plans. The LORD would give them all the help they needed, no matter what enemy they faced. All they had to do was think back and remember.

4. They had been helpless to free themselves from Pharaoh, but the LORD had helped them with His mighty power. He sent gnats, frogs, and other sadnesses...and they were free!

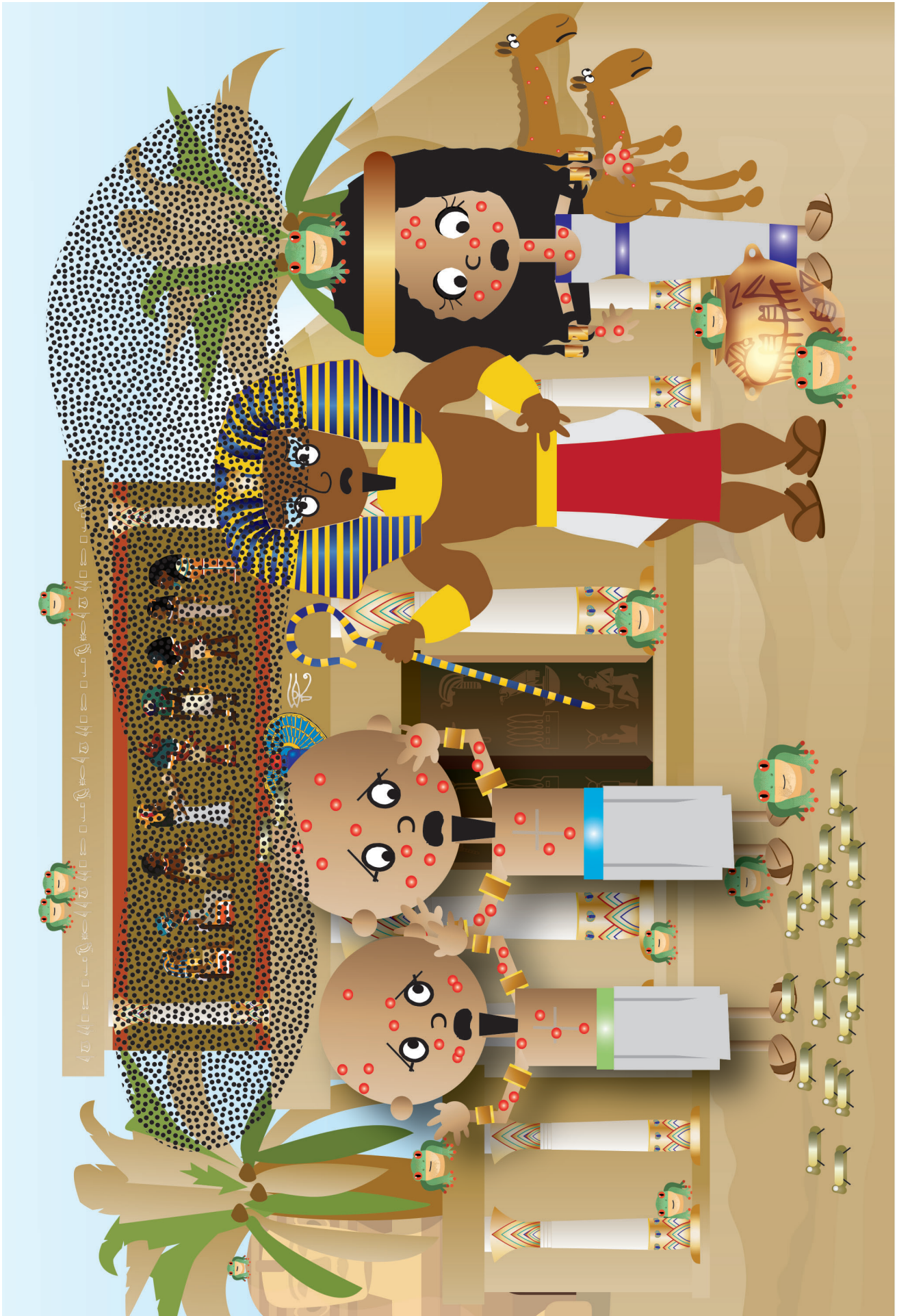

4. They had been helpless to free themselves from Pharaoh, but the LORD had helped them with His mighty power. He sent gnats, frogs, and other sadnesses...and they were free!

5. They had been helpless against Pharaoh's chariots, trapped by the Red Sea. But the LORD had helped them with His mighty power. He had parted the Red Sea and made a way for them to escape.

He washed away Pharaoh's men. Remember! Remember! The LORD would always help them.

He would always rescue them. He would always take care of them. But the people weren't remembering as they should, so the LORD allowed them to send out spies.



5. They had been helpless against Pharaoh's chariots, trapped by the Red Sea. But the LORD had helped them with His mighty power. He had parted the Red Sea and made a way for them to escape. He washed away Pharaoh's men. Remember! Remember! The LORD would always help them. He would always rescue them. He would always take care of them. But the people weren't remembering as they should, so the LORD allowed them to send out spies.

6. Twelve men were chosen: Joshua, Caleb, and ten other leaders to spy out the land for the people.

“Go through the Negev mountains, then into the grassy, hill country,” Moses ordered the men.

“Look at the people. Are there lots of them? Are they weak or strong? Do they live in tents or cities surrounded by strong walls? See what the land is like. Does it have trees? Is it good for farming?” Moses told them.

“Be brave and bring us back some fruit,” he said.



6. Twelve men were chosen: Joshua, Caleb, and ten other leaders to spy out the land for the people. "Go through the Negev mountains, then into the grassy, hill country," Moses ordered the men. "Look at the people. Are there lots of them? Are they weak or strong? Do they live in tents or cities surrounded by strong walls? See what the land is like. Does it have trees? Is it good for farming?" Moses told them. "Be brave and bring us back some fruit," he said.

7. So, sneaky, sneak, sneak went the twelve men into the Promised Land of Canaan.

First, they went through the tall, dry, Negev mountains. No one lived there and no food would grow there either. Would ALL the land God promised them be like this?



7. So, sneaky, sneak, sneak went the twelve men into the Promised Land of Canaan. First, they went through the tall, dry, Negev mountains. No one lived there and no food would grow there either. Would ALL the land God promised them be like this?

8. No, it wasn't! At last, the spies came to the grassy, hill country. Now this was MUCH better!

What beautiful views from the hills! What good farming in the valleys! Lots of fish and fresh water in the lakes and rivers. Lots of trees with red, juicy pomegranate and delicious, sweet figs, too. Yum!

And the grapes. Oh, how good were the grapes! The men cut off a huge branch covered in them and slung it over a pole to carry back to Moses and the people. It took two of them to carry just that one branch it was so big! Oh, yes! The land the LORD was giving them very good!



8. No, it wasn't! At last, the spies came to the grassy, hill country. Now this was **MUCH** better! What beautiful views from the hills! What good farming in the valleys! Lots of fish and fresh water in the lakes and rivers. Lots of trees with red, juicy pomegranate and delicious, sweet figs, too. Yum! And the grapes. Oh, how good were the grapes! The men cut off a huge branch covered in them and slung it over a pole to carry back to Moses and the people. It took two of them to carry just that one branch it was so big! Oh, yes! The land the LORD was giving them very good!

9. But, there wasn't just plenty of food in this Promised Land. There were plenty of people, too!

And not just any kind of people! These were fierce, giant people who lived in strong, tall cities and worshipped bad, fake gods. They wouldn't welcome the people of Israel to Canaan.

They would fight hard to keep their beautiful land, and they certainly seemed strong enough to beat the people of Israel and keep them out!

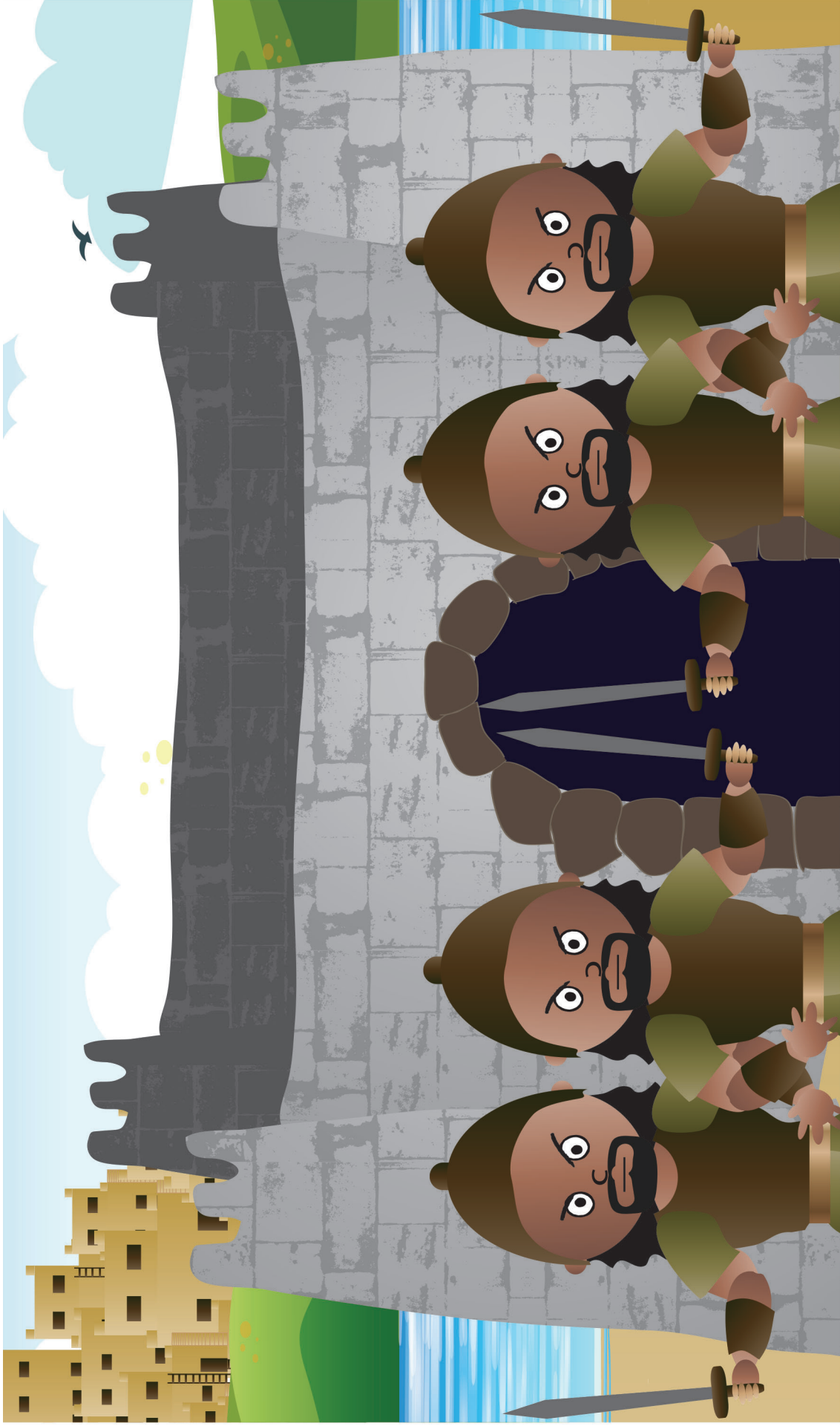

q. But, there wasn't just plenty of food in this Promised Land. There were plenty of people, too! And not just any kind of people! These were fierce, giant people who lived in strong, tall cities and worshipped bad, fake gods. They wouldn't welcome the people of Israel to Canaan. They would fight hard to keep their beautiful land, and they certainly seemed strong enough to beat the people of Israel and keep them out!

10. With fruit in hand, Joshua, Caleb, and the other, ten men started back to Kadesh Barnea.

Back through the hill country, back through the Negev mountains they went, sneak, sneak, sneaking and walk, walk, walking. Back to Moses and the people.

And as their legs were busy sneaking and walking, their minds must have been busy thinking about what to tell the people when they got back to camp.

Big fruit; big enemies; big cities. Would the people be in big trouble if they went into the Promised Land; or, could they trust in big help from the LORD?



10. With fruit in hand, Joshua, Caleb, and the other, ten men started back to Kadesh Barnea. Back through the hill country, back through the Negev mountains they went, sneak, sneak, sneaking and walk, walk, walking. Back to Moses and the people. And as their legs were busy sneaking and walking, their minds must have been busy thinking about what to tell the people when they got back to camp. Big fruit; big enemies; big cities. Would the people be in big trouble if they went into the Promised Land; or, could they trust in big help from the LORD?

11. How excited the people were when at last the twelve men returned!

“Look at that fruit! Those delicious pomegranates and figs! That huge branch of juicy grapes!” the people exclaimed.

They eagerly gathered around the twelve spies to hear more about the wonderful land of Canaan.



II. How excited the people were when at last the twelve men returned! "Look at that fruit! Those delicious pomegranates and figs! That huge branch of juicy grapes!" the people exclaimed. They eagerly gathered around the twelve spies to hear more about the wonderful land of Canaan.

12. Ten of the spies (all except Joshua and Caleb) stood up and gave their report.

“The land is beautiful and good, just as the LORD said,” they told the people, “But, the land is full of fierce giants who live in great cities with strong walls.

We can’t do it. We are helpless to fight them and take the land,” they exclaimed. “We shouldn’t even try. If we do, we will all die, we and our children!”



12. Ten of the spies (all except Joshua and Caleb) stood up and gave their report. "The land is beautiful and good, just as the LORD said," they told the people, "But, the land is full of fierce giants who live in great cities with strong walls. We can't do it. We are helpless to fight them and take the land," they exclaimed. "We shouldn't even try. If we do, we will all die, we and our children!"

13. How sad! These ten leaders had refused to remember the LORD or trust that He would keep His promise to help them.

Now, it was the people's turn. What would they do with the spies' report? Would they remember the LORD and trust in His promise to help them; or, would they choose to forget Him, just as these ten leaders had?

I'm sad to say that the people also chose to forget the LORD.

"WAAAAA!" the people wailed when they heard what the ten spies said. They cried and cried all the rest of the day and all night long.



13. How sad! These ten leaders had refused to remember the LORD or trust that He would keep His promise to help them. Now, it was the people's turn. What would they do with the spies' report? Would they remember the LORD and trust in His promise to help them; or, would they choose to forget Him, just as these ten leaders had? I'm sad to say that the people also chose to forget the LORD. "WAAAAA!" the people wailed when they heard what the ten spies said. They cried and cried all the rest of the day and all night long.

14. But, by the morning, the people's tears had dried, and their cries had stopped. Their "WAAAAAA!" changed to "GRRRRR!"

They were FURIOUS at the LORD and Moses and Aaron.

"Why did you bring us out here to be killed by these enemies?" they grumbled. "Let's get a new leader and go back to Egypt! We were better off there!" they said.

This was terrible! Moses and Aaron bowed down and prayed to the LORD for the people. They deserved the LORD's punishment for doubting His goodness and His help. Moses and Aaron begged for His mercy.



14. But, by the morning, the people's tears had dried, and their cries had stopped. Their "WAAAAA!" changed to "GRRRRR!" They were FURIOUS at the LORD and Moses and Aaron. "Why did you bring us out here to be killed by these enemies?" they grumbled. "Let's get a new leader and go back to Egypt! We were better off there!" they said. This was terrible! Moses and Aaron bowed down and prayed to the LORD for the people. They deserved the LORD's punishment for doubting His goodness and His help. Moses and Aaron begged for His mercy.

15. Then, Joshua and Caleb, the last of the twelve spies, stood up with something very different to say.

“The land we spied out is so very good. Don’t rebel against the LORD! Don’t fear the people of the land! They are nothing. The LORD is with us. He’s able to help us and give it to us,” they exclaimed.

These two leaders remembered the LORD. They trusted in His promise to help them. Would their report help the people remember and trust, too?



15. Then, Joshua and Caleb, the last of the twelve spies, stood up with something very different to say. “The land we spied out is so very good. Don’t rebel against the LORD! Don’t fear the people of the land! They are nothing. The LORD is with us. He’s able to help us and give it to us,” they exclaimed. These two leaders remembered the LORD. They trusted in His promise to help them. Would their report help the people remember and trust, too?

16. It did NOT! The people STILL refused to remember the LORD. They STILL refused to go into the beautiful Promised Land.

**They even picked up stones to throw at Moses and Aaron! Grrr!
They were so angry!**



16. It did NOT! The people STILL refused to remember the LORD. They STILL refused to go into the beautiful Promised Land. They even picked up stones to throw at Moses and Aaron! Grrrr! They were so angry!

17. Then suddenly, the bright, shiny glory of the LORD appeared. Everyone stopped in amazement. Their God was the living God! They had forgotten who He was yet again.

You see, this wasn't the first time the people had forgotten the LORD since He had rescued them from Egypt. This wasn't even the second, third, or fourth time. It was the TENTH time, and the LORD's patience had run out.

"How long will the people not believe in Me? When will they remember all the amazing things I've done for them and trust Me to help them?" the LORD said to Moses.



17. Then suddenly, the bright, shiny glory of the LORD appeared. Everyone stopped in amazement. Their God was the living God! They had forgotten who He was yet again. You see, this wasn't the first time the people had forgotten the LORD since He had rescued them from Egypt. This wasn't even the second, third, or fourth time. It was the TENTH time, and the LORD's patience had run out. "How long will the people not believe in Me? When will they remember all the amazing things I've done for them and trust Me to help them?" the LORD said to Moses.

18. “Because you didn’t believe that I would take care of you and defeat your enemies, you will NOT get to go into the Promised Land. You will wander out here in the dry desert for forty years until you grow old and die.

Instead, I will take your children to live in the beautiful land when they grow up,” the LORD told them.

How sad the people were! They hadn’t remembered the LORD. They hadn’t trusted He would help them. And now, they would never get to live in the good land He had promised them.

40 YEARS

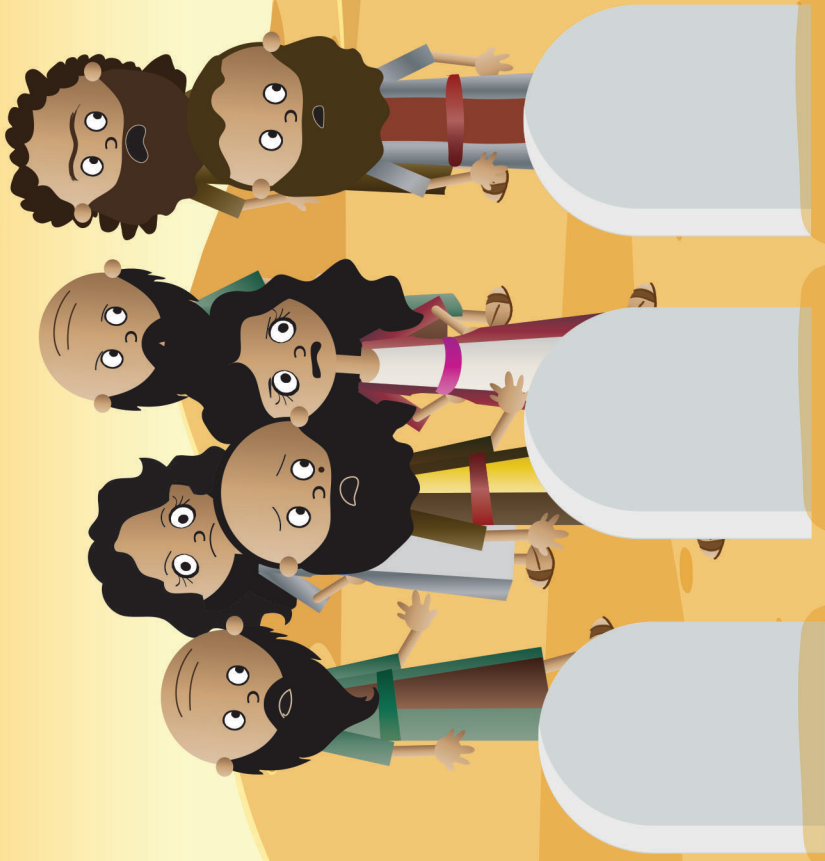

18. "Because you didn't believe that I would take care of you and defeat your enemies, you will NOT get to go into the Promised Land. You will wander out here in the dry desert for forty years until you grow old and die. Instead, I will take your children to live in the beautiful land when they grow up," the LORD told them. How sad the people were! They hadn't remembered the LORD. They hadn't trusted He would help them. And now, they would never get to live in the good land He had promised them.

19. The people, the spies, Aaron, and Moses headed out into the wilderness, leaving Canaan behind.

For the next forty years, they wandered just within reach of the Promised Land but never went in. And as the years passed, the adults grew old and died.

At last, only Joshua and Caleb, the two faithful spies, remained.



19. The people, the spies, Aaron, and Moses headed out into the wilderness, leaving Canaan behind. For the next forty years, they wandered just within reach of the Promised Land but never went in. And as the years passed, the adults grew old and died. At last, only Joshua and Caleb, the two faithful spies, remained.

20. But, the children grew up and became adults; and, the LORD made Joshua their new leader.

Now, it was time to go into the Promised Land.



20. But, the children grew up and became adults; and, the LORD made Joshua their new leader. Now, it was time to go into the Promised Land.

21. Once more, the people of Israel camped right outside of Canaan, this time by the Jordan River.

Once more, spies were sent to spy out the land. And once more, they came back with news of good fruit and powerful enemies living in strong, walled cities.

There was STILL no way for the people of Israel to beat these enemies on their own.



21. Once more, the people of Israel camped right outside of Canaan, this time by the Jordan River. Once more, spies were sent to spy out the land. And once more, they came back with news of good fruit and powerful enemies living in strong, walled cities. There was STILL no way for the people of Israel to beat these enemies on their own.

22. But that was not ALL the two spies had seen.

“The people are mighty and their cities are strong, but they have heard of the LORD and are scared,” they reported. “The LORD has surely given us this land!”



22. But that was not ALL the two spies had seen. “The people are mighty and their cities are strong, but they have heard of the LORD and are scared,” they reported. “The LORD has surely given us this land!”

23. The LORD encouraged the people, too. “I will go before you and fight your enemies,” the LORD promised Joshua and the people.

“Many years earlier, I parted the Red Sea to help you escape Pharaoh’s armies. Now, I will part the rushing, roaring waters of the Jordan River for you. I will dry up the riverbed so you can cross to the Promised Land on dry land,” He said.

“Be strong and courageous as you lead the people!” the LORD urged Joshua. “I will be with you wherever you go!” He promised.



23. The LORD encouraged the people, too. "I will go before you and fight your enemies," the LORD promised Joshua and the people. "Many years earlier, I parted the Red Sea to help you escape Pharaoh's armies. Now, I will part the rushing, roaring waters of the Jordan River for you. I will dry up the riverbed so you can cross to the Promised Land on dry land," He said. "Be strong and courageous as you lead the people!" the LORD urged Joshua. "I will be with you wherever you go!" He promised.

24. What would the people do this time? Would they remember all the LORD had done for them? Would they trust His promises to help them?

This time, the people did NOT fear! This time they DID remember, and they DID trust!

THE LORD



24. What would the people do this time? Would they remember all the LORD had done for them? Would they trust His promises to help them? This time, the people did NOT fear! This time they DID remember, and they DID trust!

25. The priests carrying the golden Ark of God's Presence, led the people toward the rushing waters of the Jordan River. If the LORD did not stop the waters, they would surely drown.

But as the first priest put out his foot to step into the swirling water, the LORD did just what He promised. He held back the river as the priests with the Ark, then all the people of Israel crossed into the promised Land for the first time!

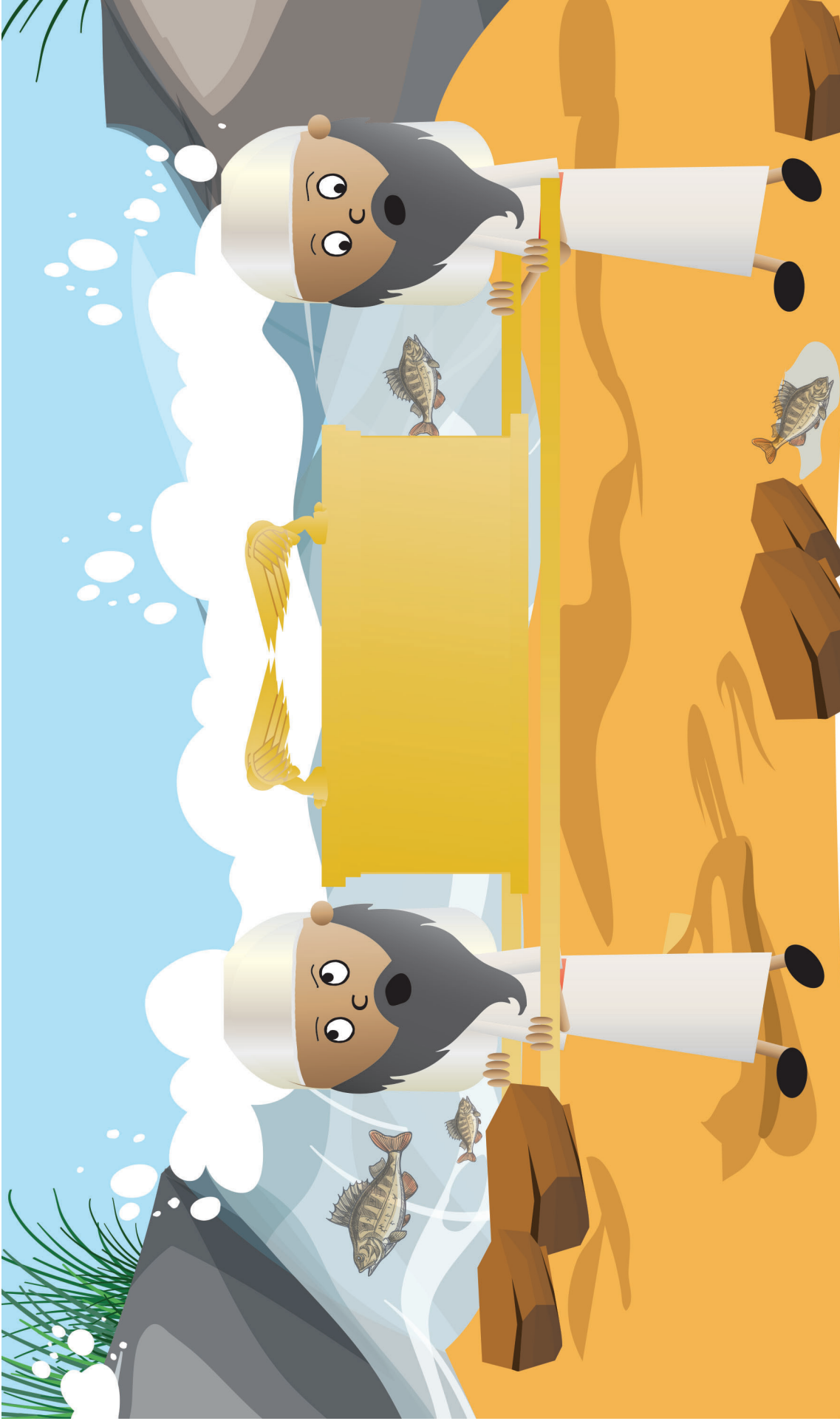

25. The priests carrying the golden Ark of God's Presence, led the people toward the rushing waters of the Jordan River. If the LORD did not stop the waters, they would surely drown. But as the first priest put out his foot to step into the swirling water, the LORD did just what He promised. He held back the river as the priests with the Ark, then all the people of Israel crossed into the Promised Land for the first time!

26. When everyone had crossed safely, the LORD told Joshua, "Choose men to pick up twelve, large stones from the Jordan River. Place them together next to the riverbank."

"These Remembering Stones will help you remember this day I brought you into Canaan on dry ground. They will help everyone in the world remember that I am the one, true, mighty God and I should be worshipped and obeyed," the LORD said.

The people obeyed. They set up the Remembering Stones and they worshipped the LORD that day.

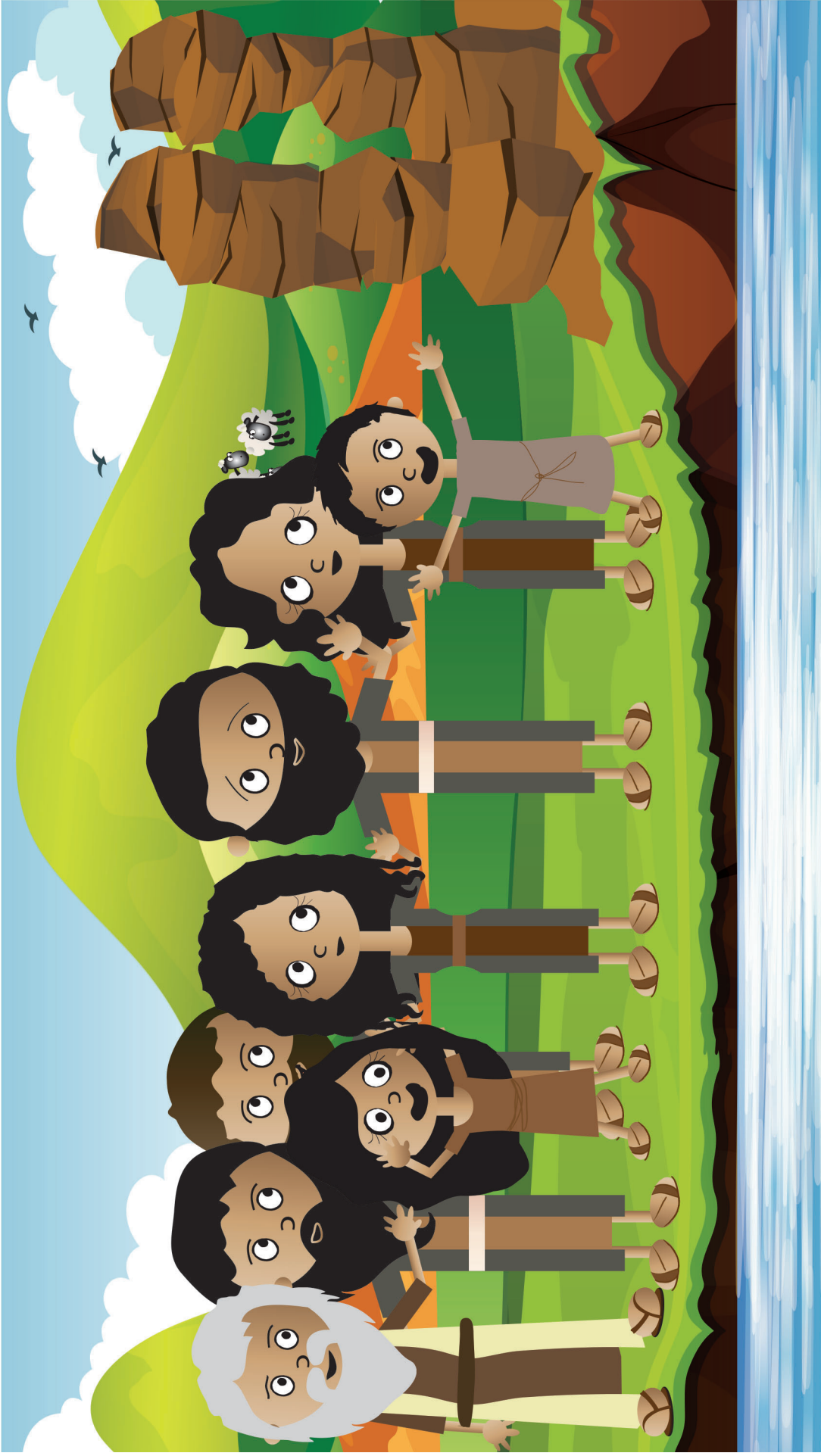

26. When everyone had crossed safely, the LORD told Joshua, "Choose men to pick up twelve, large stones from the Jordan River. Place them together next to the riverbank. These Remembering Stones will help you remember this day I brought you into Canaan on dry ground. They will help everyone in the world remember that I am the one, true, mighty God and I should be worshipped and obeyed," the LORD said. The people obeyed. They set up the Remembering Stones and they worshipped the LORD that day.

27. News spread to the enemies of what the LORD had done, and they were filled with even more fear.

They might be tall like fierce giants. Their cities might be strong and have tall walls, but who could stand against the one, true, mighty God?

The people of Israel praised the LORD. Already He was going before them. Maybe they DID have a country full of fierce, giant enemies to face, but they knew they would not have to face them alone.

They would remember the LORD and trust in Him. Surely, He would help them all the days of their lives, until every enemy was defeated, and the beautiful, Promised Land was all theirs. And the LORD did just that, just as He promised.



27. News spread to the enemies of what the LORD had done, and they were filled with even more fear. They might be tall like fierce giants. Their cities might be strong and have tall walls, but who could stand against the one, true, mighty God? The people of Israel praised the LORD. Already He was going before them. Maybe they DID have a country full of fierce, giant enemies to face, but they knew they would not have to face them alone. They would remember the LORD and trust in Him. Surely, He would help them all the days of their lives, until every enemy was defeated, and the beautiful, Promised Land was all theirs. And the LORD did just that, just as He promised.

DDD 13.2 Simple Story Scenes

SOLVED



Detective Dan's Listening Assignment #1

1. Who were the really bad remember-ers? What did they refuse to remember about God? The people of Israel were the bad remember-ers. They chose not to remember the LORD's promises to take care of them or all the ways the LORD had rescued them from their strong enemies already. They refused to trust that the LORD could really defeat the people in Canaan and give them the land as their home.

2. What happened when they remembered God's promises? They had the courage to go into Canaan. And when they did, the LORD helped them defeat their enemies and made the land their own.

For You and Me:
Like the people of Israel, the LORD wants us to remember who He is and what He is able to do. He wants us to turn to Him and trust Him to take care of us, no matter what we face in life. And what's the most important thing He's done that He wants us to remember? That He sent Jesus to save us from our sins. When we turn away from our sins and trust in Jesus as our Savior, God will make us His people. As His people, we can know that God will always sustain us. He will help us to love Him and live for Him, for the rest of our lives.

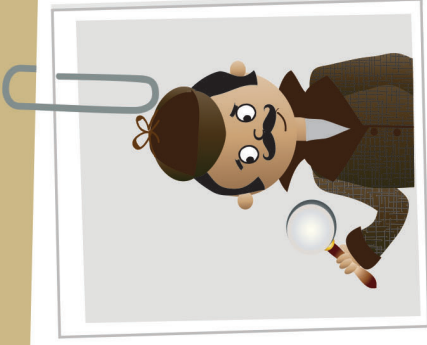

Detective Dan's Listening Assignment #2

Psalms 54:4, 6-7, ESV

"Behold, God is my helper; the Lord is the upholder of my life...I will give thanks to your name, O Lord, for it is good. For he has delivered me from every trouble, and my eye has looked in triumph on my enemies."

1. What troubles did the people of Israel face? They faced fierce enemies who lived in strong cities in the land the LORD promised them. These enemies were too strong for them and would kill them, if they fought them on their own.

2. What did the LORD promise to do for them in their troubles? The LORD promised to always be with them. He would help them beat their enemies. He would help them win the land He promised them. He would even go before them.

For You and Me:

Like the people of Israel, God holds out His promises to us. Promises to forgive our sins and make us His people. Promises to help us to live for Him, all the days of our lives. How can these promises from God become promises for us? When we turn away from our sins and trust in Jesus as our Savior. Ask God to help you. He loves to answer this prayer!

DDD 13.2 Simple Story Scenes

**Why Do God's People Keep Believing in Him?
It Is God's Sustaining Grace...
God, the Father, Promises to Help His People!**

The Gospel



The Bible is full of God's promises to help His people. But the greatest way that God has helped His people was sending His Son, Jesus, to save them from their sins.

How God, the Father, loved His Son! Yet, He send Him to suffer and die on the cross for the sins of God's people. This was the only way to save them. On the third day, Jesus rose from the dead. He had really beaten sin and death for them!

Now, we can become God's people, too, when we turn away from our sins and trust in Jesus as our Savior. He can save us and send His Holy Spirit to work in our hearts. He can help us love God and live for Him our whole lives. Ask Him to help you. He loves to answer this prayer!

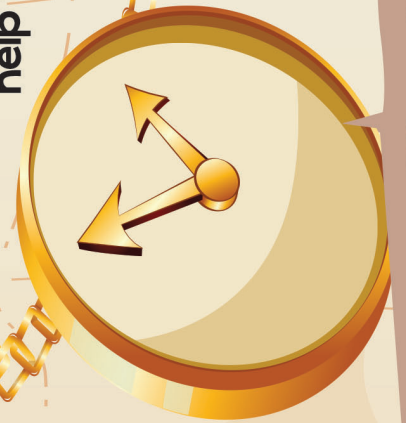

DDD 13.2 Simple Story Scenes

A Prayer

A God, we praise You for being faithful to help Your people live for You.

C We confess that many times we choose not to trust Your promises to help us. We would rather do things our own way or just depend on ourselves. We need a Savior!

T God, thank You for sending Jesus to break the power of sin and death. Thank You for Your promises to always help Your people.

S Please work in our hearts. Help us to turn away from our sins and trust in Jesus as our Savior. Help us to ask You for help and depend upon You. Help us to love You and live for You every day of our lives.

In Jesus' name we pray. Amen.



DDD 13.2 Simple Story Scenes

DEEP DOWN DETECTIVES



Simple Story Scenes

Unit 13,

Bible Truth 3

Using Simple Story Scenes as a Curriculum

Introduce the Key Concept and Bible Verse

Simple Story Scenes give you the basics for the core of your lesson. You can use the overview sheet to introduce and explain the key concept and Bible verse.

Give the Case Assignment

Give the children a Detective Dan listening assignment. Two are provided. You can add a third using the ideas on the bonus, third take-home sheet, if desired. Each listening assignment, let's you teach the story with a different learning emphasis.

Show & Tell the Story

Hold up the pictures and tell the story from the story scenes. Alternatively, you can find in the and Pieces section for this unit at praisefactory.org, these same listening assignments and story scenes, gospel and ACTS prayer modified for view on a screen. Simply download them or open them online and show through your own monitor (tablet, big screen, whatever).

Solve the Case

Repeat Detective Dan's listening assignment question and discuss the answer.

Share the Gospel

Share the gospel tie-in with the kids.

Close in ACTS Prayer

Pray the ACTS prayer with the kids. If using the curriculum with older children, give them a chance to think up their own ACTS tie-ins to the story, using the one provided as cues/ideas for you.

Review Time

Give out the take-home sheet (there are three: two that correlates to the two Detective Dan assignments in the Story Scenes, and a bonus third one.) As the children are coloring, use the take-home sheet discussion questions or your own questions to further review and apply the key concepts, Bible verse, and story truths to the children.

Looking for more?

Online, in the Bits and Pieces section for this unit, you will find review games, crafts, storyboard flannelgraph figures, and audio and sheet music for all of the songs. There are also full lesson plans that offer more of a script and take this curriculum's possibilities to much more depth. Don't forget to tell the parents about the Parents Resources section where they can read through the Story scenes and download take homes with their kids.

Unit 13: The God Who Sustains

Unit Big Question (and Answer): Why Do God's People Keep Believing in Him? It Is God's Sustaining Grace!
Unit Bible Verse: "Cast your burden on the LORD, and he will sustain you; he will never permit the righteous to be moved." --Psalm 55:22

Bible Truth 3 Concept: It Is God's Sustaining Grace... Jesus Provides God's People with Everything They Need to Live for God

God wants His people to love Him and live for Him. He wants them to love Him with all their heart, mind, and strength. He wants them to love others as themselves. He wants them to be holy, like He is holy.

God's people want to love God and live for Him. They know that they bring glory to God when they do, and they want to bring Him glory that more than anything else. But God's people are sinners with sinful hearts. They are often afraid, weak, and tempted to disobey God. How can they ever live the lives God wants them to live?

Jesus is how! God not only saved His people through Jesus, but He also promises to give them everything they need to live the lives He wants them to live through Jesus. The Bible tells us that right now in heaven, Jesus is always praying for God's people that they would glorify God and fulfill God's plans for their lives. Jesus' prayers for God's people are always answered with a yes! Jesus will always give them everything they need for life and godliness. It is His promise. What a wonderful Savior Jesus is! We can become God's people and receive all that we need to love and serve God, too, when we turn away from our sins and trust in Jesus as our Savior.

Bible Truth 3 Bible Verse: Hebrews 4:15-16, ESV

"For we do not have a high priest who is unable to sympathize with our weaknesses, but one who in every respect has been tempted as we are, yet without sin. Let us then with confidence draw near to the throne of grace, that we may receive mercy and find grace to help in time of need."

Learn a Little "Let us with confidence draw near to the throne of grace, that we may find help in time of need."

Meaning

Jesus reigns in heaven as the king over all creation and as the high priest for God's people. What does Jesus do for God's people as their high priest? He listens to their prayers and understands how hard it can be to say "no" to disobeying God. He prays for them, and He promises to give them everything they need to live for God and do all He wants them to do.

God's people know they can always pray and ask Jesus to help them. They know He loves to help them in their weakness. He loves to give them the strength they need to love God and live for Him. That's why they go boldly and confidently to Jesus with their prayers. He will always help them! We can be God's people, too, when we turn away from our sins and trust in Jesus as our Savior.

Bible Truth 3 ACTS Prayer

- A** Jesus, we praise You for being the Son of God, the Giver of all the grace God's people need to live God's way.
- C** We confess that many times we don't want to do what You want us to do, or we feel too weak to do it. We forget that if we are God's people (those who turn away from their sins and trust in Jesus), we can depend on Jesus to always give us the grace we need to live God's way. We need You to be our Savior!
- T** Thank You, Jesus, for always giving Your people the grace they need to live God's way. Thank You for promising to be praying for all who trust in You, even now, as You rule in heaven.
- S** Work in our hearts that we would turn from our sins and trust in You, Jesus, as our own Savior. Help us to love one another, and to love God and live for Him, every day of our lives.
In Jesus' name we pray, Amen.

Bible Truth 3 Story**The Case of the Man in the Middle**

Leviticus 6,16; Matthew 27; Hebrews 1-5,9,10,18

Songs Used in Bible Truth 3

Big Q & A 13 Song

Big Question 13 Song: Why Do God's People Keep Believing in Him?

Big Question 13 Bible Verse Song: Cast Your Burden on the LORD Psalm 55:22, ESV

Extra Big Question 13 Bible Verse Song: Cast Your Burden Psalm 55:22, ESV (other version)

Extra Big Question 13 Bible Verse Song: The LORD Your God Is with You Zephaniah 3:17, NIV 1984

Big Question 13 Hymn: Jesus Paid It All, v.1

Big Question 13 Praise Song: I Will Sing of the Mercies

Bible Truth 3 Bible Verse: Let Us with Confidence Hebrews 4:16, ESV

Bible Truth 3 Extra Bible Verse: Let Us Then Draw Near Hebrews 4:16, ESV

listen to or download songs for free at <https://praisefactory.org>: Deep Down Detectives Music page

“The Case of the Man in the Middle” Leviticus 6:16; Matthew 27; Hebrews

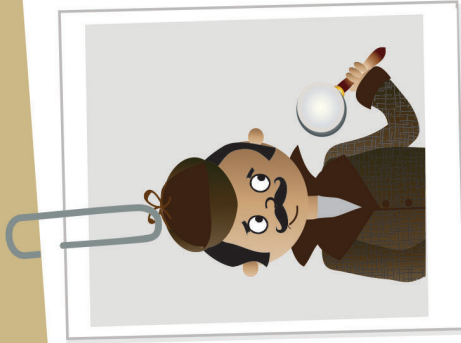

Detective Dan's Listening Assignment #1

1. What one Man stood in the middle between God and people, so they could become God's people? What worship gift did He offer up to God to make this happen?
2. What is that Man doing even now for God's people?



Detective Dan's Listening Assignment #2

Hebrews 4:16, ESV

“Let us with confidence draw near to the throne of grace, that we may find help in time of need.”

1. Who is the great high priest who offered the final worship gift for God's people?
2. What is He doing for God's people now?

(more listening and discussion questions are included in the curriculum at praisefactory.org)

I. Do you know what a holiday is? It's a day when people stop their work and get together to celebrate something special.

What holidays can you think of? New Year's Day or 4th of July? Christmas or Easter?



1. Do you know what a holiday is? It's a day when people stop their work and get together to celebrate something special. What holidays can you think of? New Year's Day or 4th of July? Christmas or Easter?

2. Well, God's people in the Bible celebrated holidays, too. Perhaps you have heard of some of them.

There was the Passover, when they celebrated how the LORD rescued His people from being slaves in Egypt.



2. Well, God's people in the Bible celebrated holidays, too. Perhaps you have heard of some of them. There was the Passover, when they celebrated how the LORD rescued His people from being slaves in Egypt.

3. There was the Feast of the Tabernacles, when they celebrated God taking care of His people as they crossed the dry wilderness and brought them to live in the Promised Land.

These holidays were days to look back and celebrate what good things God had done for them. There was so much to celebrate! God had been so good to them!



3. There was the Feast of the Tabernacles, when they celebrated God taking care of His people as they crossed the dry, wilderness and brought them to live in the Promised Land. These holidays were days to look back and celebrate what good things God had done for them. There was so much to celebrate! God had been so good to them!

4. But, the Day of Atonement was the most important holiday that God's people celebrated.

“Atonement” is a big, Bible word that means “paying for sins so we can be God's people.” Without atonement, the people could not stay God's people.

And that made the Day of Atonement the most important day of the whole year.

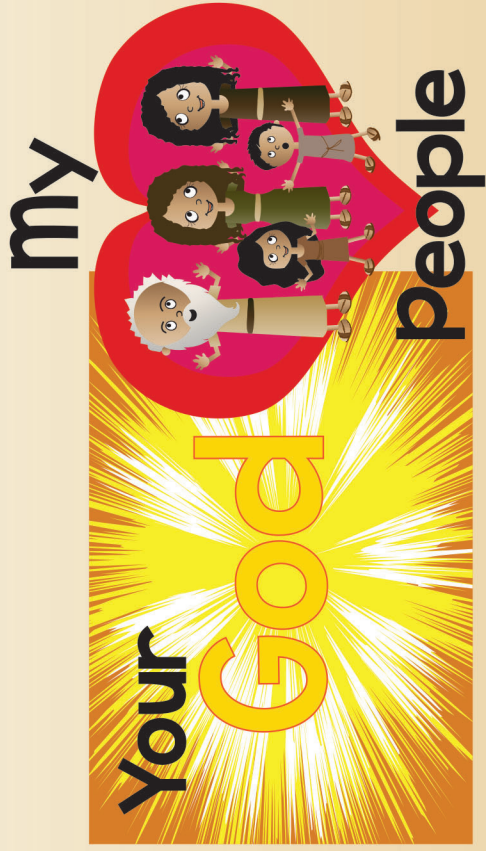

DAY OF ATONEMENT

4. But, the Day of Atonement was the most important holiday that God's people celebrated. "Atonement" is a big, Bible word that means "paying for sins so we can be God's people." Without atonement, the people could not stay God's people. And that made the Day of Atonement the most important day of the whole year.

5. You see, God is all good. He is holy. But God's people, long ago, were sinners, just like you and me. They had all disobeyed God. They had all broken their friendship with Him.

None of them deserved to be God's people. Do you know what they deserved instead? They deserved to be forgotten by God, not loved, or helped by Him. They deserved His punishment.

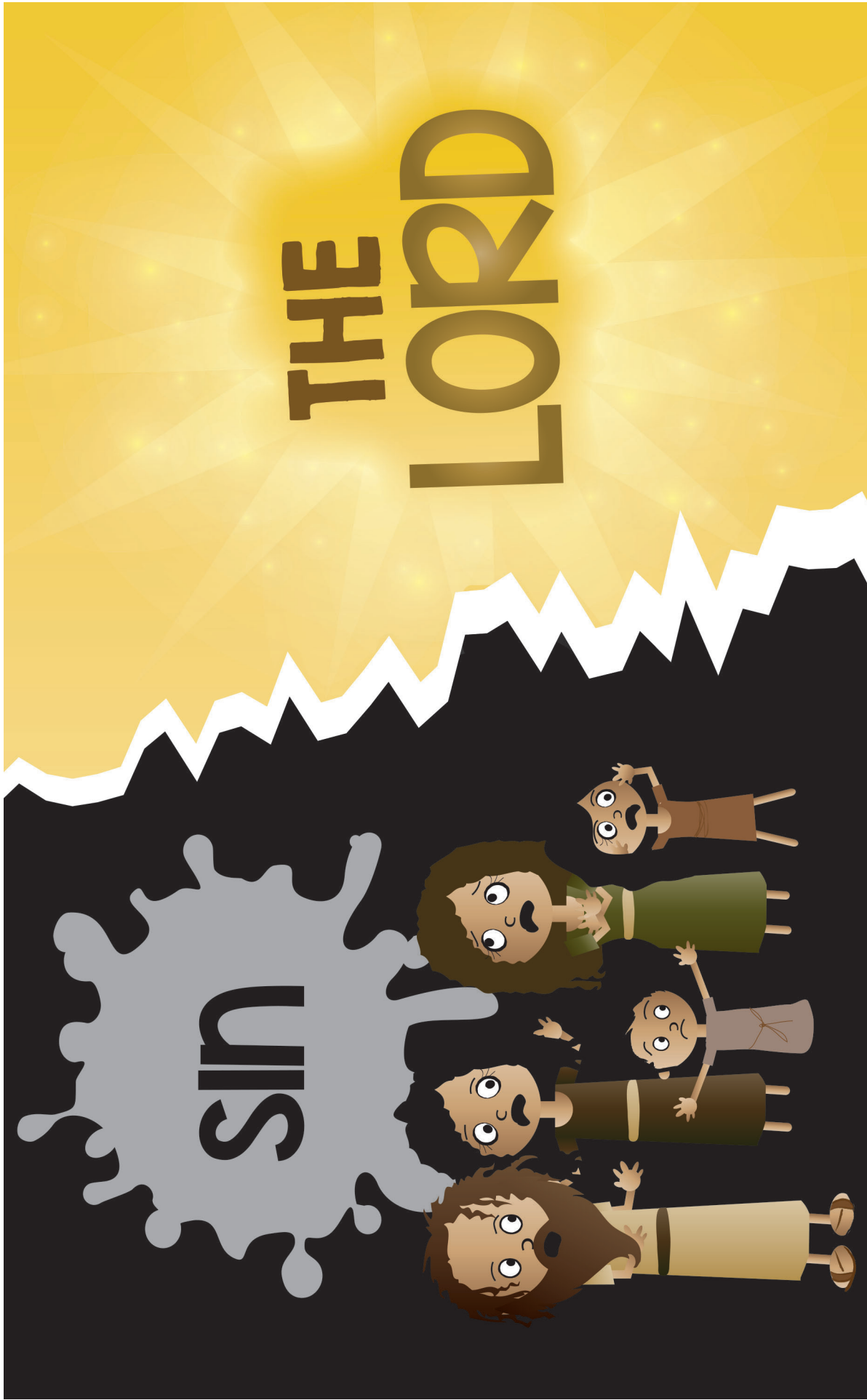

5. You see, God is all good. He is holy. But God's people, long ago, were sinners, just like you and me. They had all disobeyed God. They had all broken their friendship with Him. None of them deserved to be God's people. Do you know what they deserved instead? They deserved to be forgotten by God, not loved, or helped by Him. They deserved His punishment.

6. How could such people become God's people? Only through atonement. Only a special worship gift given to God could pay for their sins and allow them to be His people.

And this wasn't even a worship gift the people could take to God, themselves! They had to have a special PERSON to take it for them to a special MEETING PLACE, in a very special WAY.

The special meeting place was called the Tabernacle. It was the place of God's special presence here on earth. And the special person was called the High Priest.

This was the only way they could stay near God as His people.

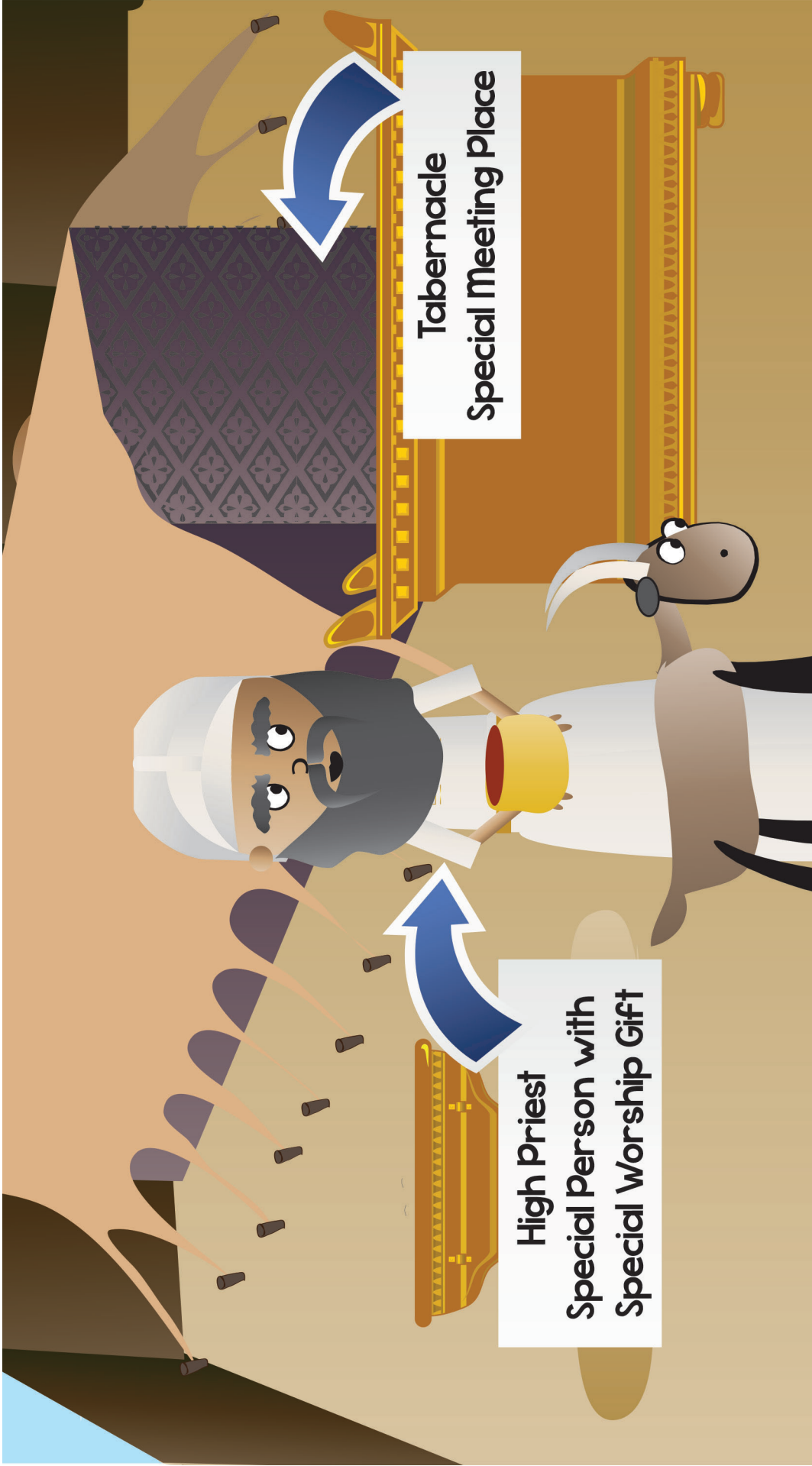

6. How could such people become God's people? Only through atonement. Only a special worship gift given to God could pay for their sins and allow them to be His people. And this wasn't even a worship gift the people could take to God, themselves! They had to have a special PERSON to take it for them to a special MEETING PLACE, in a very special WAY. The special meeting place was called the Tabernacle. It was the place of God's special presence here on earth. And the special person was called the High Priest. This was the only way they could stay near God as His people.

7. Here's the special way the high priest had to present the worship gift.

The high priest had to prepare himself very carefully. God was holy. He was not. He must do everything just right if he were to meet with God and his worship gift be accepted.

First, he washed himself from top to bottom. Scrub, scrub, scrub! Then, he went inside the Tabernacle and put on his special Atonement Day clothes, clothes that he only wore this one day of the year.

He had a special, white shirt, robe, and pants. Around his waist, he wrapped a special, white belt; and, on his head, he put a special, white hat. These clothes were so special that they were always kept in the Tabernacle.



7. Here's the special way the high priest had to present the worship gift. The high priest had to prepare himself very carefully. God was holy. He was not. He must do everything just right if he were to meet with God and his worship gift be accepted. First, he washed himself from top to bottom. Scrub, scrub, scrub! Then, he went inside the Tabernacle and put on his special Atonement Day clothes, clothes that he only wore this one day of the year. He had a special, white shirt, robe, and pants. Around his waist, he wrapped a special, white belt; and, on his head, he put a special, white hat. These clothes were so special that they were always kept in the Tabernacle.

8. After the high priest had washed and dressed like this, it was time for him to intercede (pray) for the people.

The people gathered outside the Tabernacle and watched as the high priest went in and out of the Tabernacle two times. Each time, he prepared a special worship gift and took it to present to the LORD.



8. After the high priest had washed and dressed like this, it was time for him to intercede (pray) for the people. The people gathered outside the Tabernacle and watched as the high priest went in and out of the Tabernacle two times. Each time, he prepared a special worship gift and took it to present to the LORD.

9. The first gift was for the high priest's own sin. He took it into the Tabernacle and went behind the beautiful curtain covered in cherubim at the back.

This tiny room was called the Most Holy Place. In it was the Ark of the Covenant, a golden box with two, cherubim angels bending over its cover.

Inside the Ark were the Ten Commandments, the 10 Big, Laws God had given through Moses for His people to obey. The Most Holy Place was where God promised to receive the high priest's worship gifts and hear him intercede for (pray) the people.



9. The first gift was for the high priest's own sin. He took it into the Tabernacle and went behind the beautiful curtain covered in cherubim at the back. This tiny room was called the Most Holy Place. Inside the Ark were the Ten Commandments, the 10 Big Laws God had given through Moses for His people to obey. The Most Holy Place was where God promised to receive the high priest's worship gifts and hear him intercede for (pray) the people.

10. Standing in front of the Ark was like standing before God in heaven.

The high priest sprinkled some of the worship gift onto the Ark, then prayed, “Forgive me, LORD, so I can come before You and pray for the people,” as he offered his worship gift.



10. Standing in front of the Ark was like standing before God in heaven. The high priest sprinkled some of the worship gift onto the Ark, then prayed, "Forgive me, LORD, so I can come before You and pray for the people," as he offered his worship gift.

II. Next, the high priest went back out and prepared the worship gift for the people. Then, once more, he went into the Most Holy Place and sprinkled some of this worship gift onto the Ark.

This time, he prayed for the people. “Forgive Your people’s sins. Be near us. Keep us close to You, so we can be Your people another year. LORD, help Your people,” he prayed, as he offered the worship gift for them.



II. Next, the high priest went back out and prepared the worship gift for the people. Then, once more, he went into the Most Holy Place and sprinkled some of this worship gift onto the Ark. This time, he prayed for the people. “Forgive Your people’s sins. Be near us. Keep us close to You, so we can be Your people another year. LORD, help Your people,” he prayed,” he offered the worship gift for them.

12. When he finished offering these gifts, the high priest took off his white clothes and put his regular, high priest clothes back on.

Then, he went outside the Tabernacle and the people watched as he offered two more worship gifts upon the big, fiery, bronze altar that stood near the Tabernacle.

These were burnt offerings, one for the high priest and one for the people. Once more, he prayed for the LORD to receive these offerings and keep them as His people.



12. When he finished offering these gifts, the high priest took off his white clothes and put his regular, high priest clothes back on. Then, he went outside the Tabernacle and the people watched as he offered two more worship gifts upon the big, fiery, bronze altar that stood near the Tabernacle. These were burnt offerings, one for the high priest and one for the people. Once more, he prayed for the LORD to receive these offerings and keep them as His people.

13. And then it was all done, at least until the next year. The LORD had accepted the worship gifts. He had made the way for His sinful people to stay near Him as His dearly-loved people for another year.

How grateful the people were for this plan that the LORD had set up! How they needed that high priest, that man in the middle! He was the only way they could stay near the LORD as His people!



13. And then it was all done, at least until the next year. The LORD had accepted the worship gifts. He had made the way for His sinful people to stay near Him as His dearly-loved people for another year. How grateful the people were for this plan that the LORD had set up! How they needed that high priest, that man in the middle! He was the only way they could stay near the LORD as His people!

14. For hundreds of years, God's people saw one high priest after another come and go into that Most Holy Place. Each offered the special gifts. Each prayed the special prayers asking God to be near His people, to provide for them, and to forgive their sins for another year.

Why did those high priests have to go back, year after year? Why couldn't they just go in once and make one, big worship gift for the people for all time? Well, it was because there was something wrong with every single one of those high priests and every single one of the worship gifts they offered. They weren't good enough to forgive the sins of God's people!



14. For hundreds of years, God's people saw one high priest after another come and go into that Most Holy Place. Each offered the special gifts. Each prayed the special prayers asking God to be near His people, to provide for them, and to forgive their sins for another year. Why did those high priests have to go back, year after year? Why couldn't they just go in once and make one, big worship gift for the people for all time? Well, it was because there was something wrong with every single one of those high priests and every single one of the worship gifts they offered. They weren't good enough to forgive the sins of God's people!

15. You see, all those men may have scrubbed their skin until it was shiny clean. They all may have worn special, white clothes. And, they all may have gone into the Most Holy Place on the right day, in just the right way.

But the problem was that underneath it all, every one of those high priests had something bad in their hearts, just like everyone else. Do you know what it was?

It was sin!



15. You see, all those men may have scrubbed their skin until it was shiny clean. They all may have worn special, white clothes. And, they all may have gone into the Most Holy Place on the right day, in just the right way. But the problem was that underneath it all, every one of those high priests had something bad in their hearts, just like everyone else. Do you know what it was? It was sin!

16. By God's law, only a PERFECT high priest, with NO SIN, bringing a PERFECT worship gift would be good enough for God to forgive sins. Only this kind of high priest could truly intercede for the people and have God answer his prayers for the people.

That's why all these high priests and their worship gifts were just tie-overs until the perfect, REAL high priest with the perfect, FINAL worship gift came. THIS high priest would put an end to the worship gifts forever. He would pray for God's people and His prayers would last forever.

But WHERE would the people ever find a perfect high priest with a perfect worship gift? Was there no hope for God's people?

**PERFECT
HIGH
PRIEST**

**PERFECT
WORSHIP GIFT
FOR SIN**



16. By God's law, only a PERFECT high priest, with NO SIN, bringing a PERFECT worship gift would be good enough for God to forgive sins. Only this kind of high priest could truly intercede for the people and have God answer his prayers for the people. That's why all these high priests and their worship gifts were just tie-overs until the perfect, REAL high priest with the perfect, FINAL worship gift came. THIS high priest would put an end to the worship gifts forever. He would pray for God's people and His prayers would last forever. But WHERE would the people ever find a perfect high priest with a perfect worship gift? Was there no hope for God's people?

17. Yes, there was hope! There would never be a perfect high priest or a perfect worship gift among the people, but God would send them one from heaven: His perfect Son, Jesus!



17. Yes, there was hope! There would never be a perfect high priest or a perfect worship gift among the people, but God would send them one from heaven: His perfect Son, Jesus!

18. Yes, Jesus came from heaven to be born a baby. He was God's Son, but now he was a human, too, the son of Mary.



18. Yes, Jesus came from heaven to be born a baby. He was God's Son, but now he was a human, too, the son of Mary.

19. Jesus didn't stay a baby. He grew up, up, up to be a man. And with every day of His life, Jesus always loved God and kept all of God's laws.



19. Jesus didn't stay a baby. He grew up, up, up to be a man. And with every day of His life, Jesus always loved God and kept all of God's laws.

20. Jesus was perfect! And because He was perfect, He could be the perfect high priest God planned Him to be.

Here, at last, was the One who could be the final Middle Man. He could present a worship gift for the sins of God's people that would last forever.

But where would Jesus get the needed worship gift? It had to be just as perfect as He was. There was only One who could be that perfect, worship gift. It was Jesus, Himself. Yes, Jesus would be not just the perfect high priest, but the perfect worship gift for sin, too.

Perfect Law Keeper to Be the Perfect Payment for Sins



20. Jesus was perfect! And because He was perfect, He could be the perfect high priest God planned Him to be. Here, at last, was the One who could be the final Middle Man. He could present a worship gift for the sins of God's people that would last forever. But where would Jesus get the needed worship gift? It had to be just as perfect as He was. There was only One who could be that perfect, worship gift. It was Jesus, Himself. Yes, Jesus would be not just the perfect high priest, but the perfect worship gift for sin, too.

21. And that's just what Jesus did, though it was so very hard. Jesus went to the cross to suffer and die. He gave His own life as the perfect worship gift, the perfect payment, for the sins of God's people, once and for all time!



2! And that's just what Jesus did, though it was so very hard. Jesus went to the cross to suffer and die. He gave His own life as the perfect worship gift, the perfect payment, for the sins of God's people, once and for all time!

22. And, while the other high priests took their worship gifts into the Tabernacle, behind the cherubim curtain, to sprinkle on the Ark of God's presence here on earth, Jesus took His worship to a very different place.

When Jesus died, He went up to heaven and stood before the real cherubim and God, His Father. And there, Jesus presented His very life as the one, final, perfect worship gift for all of God's people.

And do you think God accepted it? He certainly did! Now, God's people will always be near to God as His dearly-loved people.



22. And, while the other high priests took their worship gifts into the Tabernacle, behind the cherubim curtain, to sprinkle on the Ark of God's presence here on earth, Jesus took His worship to a very different place. When Jesus died, He went up to heaven and stood before the real cherubim and God, His Father. And there, Jesus presented His very life as the one, final, perfect worship gift for all of God's people. And do you think God accepted it? He certainly did! Now, God's people will always be near to God as His dearly-loved people.

23. Rippppp! That beautiful curtain in front of the Most Holy Place split in two when Jesus died. The true high priest had come and made atonement. God and His people could be together now.

“It is finished!”



23. Rippppp! That beautiful curtain in front of the Most Holy Place split in two when Jesus died. The true high priest had come and made atonement. God and His people could be together now.

24. And on the third day, Jesus proved it, when He rose from dead. God had accepted Jesus' perfect worship gift. He had beaten sin and death for God's people.



24. And on the third day, Jesus proved it, when He rose from dead. God had accepted Jesus' perfect worship gift. He had beaten sin and death for God's people.

25. Then, Jesus rose up to heaven to rule.

He's there, even now. And He STILL continues to be the Man in the Middle, the great high priest, for all of God's people.

All day, all night, all the time, not just once a year, Jesus is interceding (praying) for them. And guess what God's answer to all of Jesus' prayers for them is?



25. Then, Jesus rose up to heaven to rule. He's there, even now. And He **STILL** continues to be the Man in the Middle, the great high priest, for all of God's people. All day, all night, all the time, not just once a year, Jesus is interceding (praying) for them. And guess what God's answer to all of Jesus' prayers for them is?

26. It's always "Yes and Amen!"

Yes, your sins are forgiven, FOREVER! Yes, everything you need to live for God will be given, FOREVER! Yes, you will always be close to God and He will be close to you!

Jesus makes sure that God's people keep on believing in and living for God their whole lives. He gives them everything they need to live for God! What a wonderful high priest God's people have in Jesus!

Thank You, God, for sending Your Son to be the Man in the Middle that we need!



26. It's always "Yes and Amen!" Yes, your sins are forgiven, FOREVER! Yes, everything you need to live for God will be given, FOREVER! Yes, you will always be close to God and He will be close to you! Jesus makes sure that God's people keep on believing in and living for God their whole lives. He gives them everything they need to live for God! What a wonderful high priest God's people have in Jesus! Thank You, God, for sending Your Son to be the Man in the Middle that we need!

DDD 13.3 Simple Story Scenes

"The Case of the Man in the Middle" Leviticus 6,16; Matthew 27; Hebrews

SOLVED



Detective Dan's Listening Assignment #1

1. What one Man stood in the middle between God and people, so they could become God's people? What worship gift did He offer up to God to make this happen? Jesus was the man in the middle. Jesus was the final, high priest who offered up His own perfect life as the worship gift to pay for the sins of God's people.

2. What is that Man doing even now for God's people? He is ruling in heaven. He is carrying out His Father's good plans. He is listening to the prayers of God's people and praying for them. He is making sure they have everything they need for life and godliness.

For You and Me:
God's people long ago needed Jesus, the perfect High priest, to pay for their sins and bring them to God, once and for all time. We need Jesus to do this for us, too. He is happy to, when we turn away from our sins and trust in Him as our Savior. Ask Him to help you! He loves to answer this prayer!



Detective Dan's Listening Assignment #2

Hebrews 4:16, ESV

"Let us with confidence draw near to the throne of grace, that we may find help in time of need."

1. Who is the great high priest who offered the final worship gift for God's people? Jesus is.

2. What is He doing for God's people now? He is ruling in heaven. He is carrying out His Father's good plans. He is listening to the prayers of God's people and is praying for them. He is making sure they have everything they need for life and godliness.

For You and Me:

God's people long ago needed Jesus, the perfect High priest, to pay for their sins and bring them to God, once and for all time. We need Jesus to do this for us, too. He is happy to, when we turn away from our sins and trust in Him as our Savior. And, if you do, you, too, can know that He is ever praying for you. He will help you keep on believing in God and living for Him.

DDD 13.3 Simple Story Scenes

**Why Do God's People Keep Believing in Him?
It Is God's Sustaining Grace...
Jesus Provides God's People with Everything
They Need to Live for God!**

The Gospel



We need Jesus to provide us with everything we need to live for God. Why? Because we have all chosen to turn away from God. We can never please God or love Him or live for Him by ourselves. And that's why God, in His great mercy, sent His Son, Jesus.

Jesus lived a perfect life, then He gave His life to be the full payment for the sins of God's people, when He suffered and died on the cross. Then, on Day Three, Jesus rose from the dead in victory. Now, Jesus is in heaven, where He rules over everything and where He is still helping God's people. He is always listening to their prayers and praying for them. Jesus is making sure God's people have everything they need to love God and live for Him.

These can be God's gifts to us, too, when we turn away from our sins and trust in Jesus as our Savior. This is how we become God's people. How good God has been to us by sending Jesus!

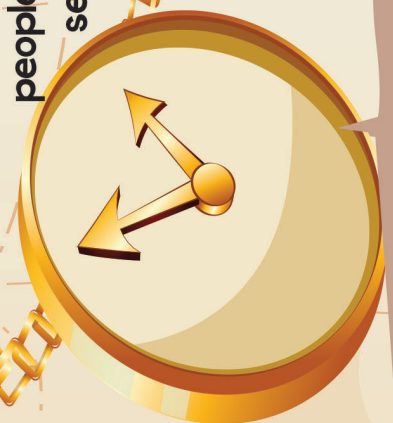

DDD 13.3 Simple Story Scenes

A Prayer

A Jesus, we praise You for being the Son of God, the Giver of all the grace God's people need to live God's way.

C We confess that many times we don't want to do what You want us to do, or we feel too weak to do it. We forget that if we are God's people (those who turn away from their sins and trust in Jesus), we can depend on Jesus to always give us the grace we need to live God's way. We need You to be our Savior!

T Thank You, Jesus, for always giving Your people the grace they need to live God's way. Thank You for promising to be praying for all who trust in You, even now, as You rule in heaven.

S Work in our hearts that we would turn from our sins and trust in You, Jesus, as our own Savior. Help us to love one another, and to love God and live for Him, every day of our lives.

In Jesus' name we pray. Amen.



DDD 13.3 Simple Story Scenes

DEEP DOWN DETECTIVES



Simple Story Scenes

Unit 13,

Bible Truth 4

Using Simple Story Scenes as a Curriculum

Introduce the Key Concept and Bible Verse

Simple Story Scenes give you the basics for the core of your lesson. You can use the overview sheet to introduce and explain the key concept and Bible verse.

Give the Case Assignment

Give the children a Detective Dan listening assignment. Two are provided. You can add a third using the ideas on the bonus, third take-home sheet, if desired. Each listening assignment, let's you teach the story with a different learning emphasis.

Show & Tell the Story

Hold up the pictures and tell the story from the story scenes. Alternatively, you can find in the and Pieces section for this unit at praisefactory.org, these same listening assignments and story scenes, gospel and ACTS prayer modified for view on a screen. Simply download them or open them online and show through your own monitor (tablet, big screen, whatever).

Solve the Case

Repeat Detective Dan's listening assignment question and discuss the answer.

Share the Gospel

Share the gospel tie-in with the kids.

Close in ACTS Prayer

Pray the ACTS prayer with the kids. If using the curriculum with older children, give them a chance to think up their own ACTS tie-ins to the story, using the one provided as cues/ideas for you.

Review Time

Give out the take-home sheet (there are three: two that correlates to the two Detective Dan assignments in the Story Scenes, and a bonus third one.) As the children are coloring, use the take-home sheet discussion questions or your own questions to further review and apply the key concepts, Bible verse, and story truths to the children.

Looking for more?

Online, in the Bits and Pieces section for this unit, you will find review games, crafts, storyboard flannelgraph figures, and audio and sheet music for all of the songs. There are also full lesson plans that offer more of a script and take this curriculum's possibilities to much more depth. Don't forget to tell the parents about the Parents Resources section where they can read through the Story scenes and download take homes with their kids.

Unit 13: The God Who Sustains

Unit Big Question (and Answer): Why Do God's People Keep Believing in Him? It Is God's Sustaining Grace!

Unit Bible Verse: "Cast your burden on the LORD, and he will sustain you; he will never permit the righteous to be moved." --Psalm 55:22

Bible Truth 4 Concept: It Is God's Sustaining Grace... The Holy Spirit Works Inside of God's People!

God created all people with a special heart, deep inside of them. It's different from the heart in your body that pumps blood and you feel beating. This special heart is invisible, but it's the part of you that lives forever and can know God. In the Bible, this special heart is also called our spirit.

The sad news is that the beautiful, special heart that God gave us is broken with sin. Yes, we have all chosen to turn away from God and disobey Him. We deserve His punishment, not His friendship.

But there's good news, too! God's Holy Spirit can work in our heart and change it. He does this when we listen to God's Word and when we pray. He can help us see our sins, turn away from them, and trust in Jesus as our Savior. This is how we become God's people. And when we do, He makes our heart clean and new, able to know God and want to love and serve Him.

And that's just the beginning of what the Holy Spirit does inside us when we become God's people. He goes on working in our hearts, making the most amazing changes. He helps us know God and want to live for Him more and more. He gives us wisdom to understand God's Word and boldness to tell others about Him. He helps us turn away from anger, jealousy, hatred, and pride. He grows love, peace, patience, kindness, joy, goodness, and self-control in their place. What a wonderful gift the Holy Spirit is! God's people would never be able to keep on loving God and living for Him, if the Holy Spirit didn't live inside them. The Holy Spirit can come and live in our hearts, too, when we turn away from our sins and trust in Jesus as our Savior.

Bible Truth 4 Bible Verse: 2 Corinthians 1:21-22, ESV

"And it is God who establishes us with you in Christ, and has anointed us, and who has also put his seal on us and given us his Spirit in our hearts as a guarantee."

Learn a Little "God establishes us in Christ, and has given us his spirit in our hearts."

Meaning

God's people keep on believing in God because God, Himself, establishes them. That means He makes sure they keep on standing firm in their trust in Him. Jesus is the Christ. He's the special one sent by God to save sinners and make them God's people forever. It's because of Jesus that God's people stand firm in their faith. Jesus bought them with His blood. He paid for them and owns them. They will always stand firm in the faith because no one can ever take them away from Him. They will be God's dearly-loved people forever. And as His people, forgiven through Jesus, God gives them another, most wonderful gift: He puts His Holy Spirit in their hearts.

The Holy Spirit reminds them that they are God's dearly loved people. He helps them remember the truths of God's Word and believe them. He helps them be strong and brave in Jesus. He reminds them that they belong to God and one day will go to live with Him forever.

God's people never have to go through anything alone. God's Holy Spirit is always with them, living inside of them. And He will go on living inside them their whole lives. We can become God's people, too, when we turn away from our sins and trust in Jesus as our Savior.

Bible Truth 4 ACTS Prayer

Holy Spirit, we praise You for the way You can powerfully work in our hearts, changing us from the inside out.

God, we confess that many times we are proud, jealous, envious, and hateful. We need Jesus to save us. We need Your Holy Spirit to replace with humility and love. We need a Savior!

Thank You, Holy Spirit, for being stronger than any of our sins. Thank You for being able to work powerfully in our hearts and truly change us.

Holy Spirit, work in our hearts, help us to turn away from our sins and trust in Jesus as our Savior. Fill our heart with Your good ways. Make us joyful, peaceful, kind, patience, self-controlled, joyful, loving, and good. Give us wisdom and make us bold and strong to do God's will. In Jesus' name we pray, Amen.

Bible Truth 4 Story**The Case of the Foolish Forgetters**

Galatians

Songs Used in Bible Truth 4

Big Q & A 13 Song

Big Question 13 Song: Why Do God's People Keep Believing in Him?

Big Question 13 Bible Verse Song: Cast Your Burden on the LORD Psalm 55:22, ESV

Extra Big Question 13 Bible Verse Song: Cast Your Burden Psalm 55:22, ESV (other version)

Extra Big Question 13 Bible Verse Song: The LORD Your God Is with You Zephaniah 3:17, NIV 1984

Big Question 13 Hymn: Jesus Paid It All, v.1

Big Question 13 Praise Song: I Will Sing of the Mercies

Bible Truth 4 Bible Verse: It Is God Who Establishes Us with You 2 Corinthians 1:21-22, ESV

Bible Truth 4 Extra Bible Verse: And It Is God 2 Corinthians 1:21-22, ESV

Bible Truth 4 Extra Bible Verse: The Fruit of the Spirit Galatians 5:22,25, ESV

Bible Truth 4 Extra Bible Verse: The Fruit Galatians 5:22,25, ESV

Bible Truth 4 Extra Bible Verse: I Will Ask the Father John 14:16-17, ESV

Bible Truth 4 Extra Bible Verse: I Will Give You a New Heart Ezekiel 36:26, ESV

Bible Truth 4 Extra Bible Verse: You Shall Be Clean Ezekiel 36:25-27, ESV

listen to or download songs for free at <https://praisefactory.org>: Deep Down Detectives Music page

“The Case of the Foolish Forgetters” The Book of Galatians



Detective Dan's Listening Assignment #1

Foolish means doing something without thinking it through well, and something bad happens.

1. Who was foolish? What were they doing without thinking it through well?
2. What did they forget?



Detective Dan's Listening Assignment #2

2 Corinthians 1:21-22, ESV

“And it is God who establishes us with you in Christ, and has anointed us, and who has also put his seal on us and given us his Spirit in our hearts as a guarantee.”

1. Who did the Galatians forget to depend on to help them live for God?
2. Who did they need to have live in their hearts and help them live for God?

(more listening and discussion questions are included in the curriculum at praisefactory.org)

I. “Good news! Come hear my good news!” Paul announced, as Silas and he travelled through the land of Galatia.

They went up tall mountains and down low valleys; through thick forests and alongside winding rivers. And everywhere they went, Paul told the people the good news of salvation through faith in God’s Son.

Can you remember the name of God’s Son? It’s Jesus! Yes, everywhere Paul went, he told people how they could become God’s people through Jesus.



1. "Good news! Come hear my good news!" Paul announced, as Silas and he travelled through the land of Galatia. They went up tall mountains and down low valleys; through thick forests and alongside winding rivers. And everywhere they went, Paul told the people the good news of salvation through faith in God's Son. Can you remember the name of God's Son? It's Jesus! Yes, everywhere Paul went, he told people how they could become God's people through Jesus.

2. Some of the people Paul talked to were Jews.

They had grown up knowing about the LORD. They knew God's Word and had been taught His laws. Each week, they gathered together to praise God and learn more about Him.



2. Some of the people Paul talked to were Jews. They had grown up knowing about the LORD. They knew God's Word and had been taught His laws. Each week, they gathered together to praise God and learn more about Him.

3. The Jews tried to keep all of God's laws, but couldn't.

Why? Because they had sin in their hearts, just like we do. They were law-breakers, not perfect law-keepers.

Oh, how could they ever please God if they couldn't keep His laws?

God's Laws



3. The Jews tried to keep all of God's laws, but couldn't. Why? Because they had sin in their hearts, just like we do. They were law-breakers, not perfect law-keepers. Oh, how could they ever please God if they couldn't keep His laws?

4. Paul opened the Bible, God's Word, and told them how.

"I've got good news for you! You can't keep God's laws perfectly, but Jesus could!" Paul said. "Jesus is God's Son, the Messiah, sent to save us from our sins, just as God promised.

"Jesus obeyed God's laws perfectly. He offered up His life as the perfect sacrifice for the sins of God's people when He suffered and died on the cross."

"On the third day, Jesus rose from the dead, proving He had really fulfilled all of God's laws and beaten sin and death for God's people," Paul told them.

Jesus Kept God's Laws Perfectly



Jesus Beat Sin & Death for God's People



4. Paul opened the Bible, God's Word, and told them how. "I've got good news for you! You can't keep God's laws perfectly, but Jesus could!" Paul said. "Jesus is God's Son, the Messiah, sent to save us from our sins, just as God promised. Jesus obeyed God's laws perfectly. He offered up His life as the perfect sacrifice for the sins of God's people when He suffered and died on the cross. On the third day, Jesus rose from the dead, proving He had really fulfilled all of God's laws and beaten sin and death for God's people," Paul told them.

5. “Turn away from trying to please God on your own. Repent of your sins and trust in Jesus as your Savior. This is how you can be God’s people.”

“Stop trying to deserve to be God’s people with your own law-keeping! No one is good enough to do that,” Paul urged them.

Hmmmm... This was very, VERY different from anything these Jews had heard before. Could Jesus really be the Messiah? Could He really be the one God promised to save them from their sins? Had He really fulfilled all of God’s laws in their place?

This was a lot to think about. Would they believe this good news Paul preached this day?



5. "Turn away from trying to please God on your own. Repent of your sins and trust in Jesus as your Savior. This is how you can be God's people. Stop trying to deserve to be God's people with your own law-keeping! No one is good enough to do that," Paul urged them. Hmmm... This was very, VERY different from anything these Jews had heard before. Could Jesus really be the Messiah? Could He really be the one God promised to save them from their sins? Had He really fulfilled all of God's laws in their place? This was a lot to think about. Would they believe this good news Paul preached this day?

6. The Holy Spirit worked in the hearts of many Jews that day.

He helped them turn away from their sins and trust in Jesus as their Savior. He filled their hearts with joy and gave them power to live a new life for God.

How happy they were that Jesus had saved them! How much better it was to have the Holy Spirit working inside them, helping them know God and live for Him! How glad they were to be free from trying to please God just by keeping His laws and never being able to do it! Yay!



6. The Holy Spirit worked in the hearts of many Jews that day. He helped them turn away from their sins and trust in Jesus as their Savior. He filled their hearts with joy and gave them power to live a new life for God. How happy they were that Jesus had saved them! How much better it was to have the Holy Spirit working inside them, helping them know God and live for Him! How glad they were to be free from trying to please God just by keeping His laws and never being able to do it! Yay!

7. But Paul's good news wasn't just for the Jews in Galatia. It was for the Gentiles who lived there, too.

The Gentiles didn't know God's Word or His laws. They had grown up worshipping fake gods, like Hermes and Zeus. They gave their worship gifts to these fake gods and honored them with wild, worship parties and other bad things.

How far from the LORD these Gentiles were! Oh, how would they ever please Him, the one, true God, if they kept worshipping these fake gods and doing these bad things?



7. But Paul's good news wasn't just for the Jews in Galatia. It was for the Gentiles who lived there, too. The Gentiles didn't know God's Word or His laws. They had grown up worshipping fake gods, like Hermes and Zeus. They gave their worship gifts to these fake gods and honored them with wild, worship parties and other bad things. How far from the LORD these Gentiles were! Oh, how would they ever please Him, the one, true God, if they kept worshipping these fake gods and doing these bad things?

8. It was only through Jesus!



8. It was only through Jesus!

9. So, Paul told the good news of Jesus to all the Gentiles who would listen.

“Your gods are fake gods. I’ve come to tell you about the LORD, one, true God!” Paul told them. “HE is the One who created this whole world. He created you. He’s the One who gives you food to eat and all the other things that you enjoy,” Paul explained.

“And now, He’s sent His Son, Jesus, to save you from your sins and give you eternal life. Come, know the living God! Turn away from your fake gods and your sins! Put your trust in Jesus and be saved!” Paul exclaimed.

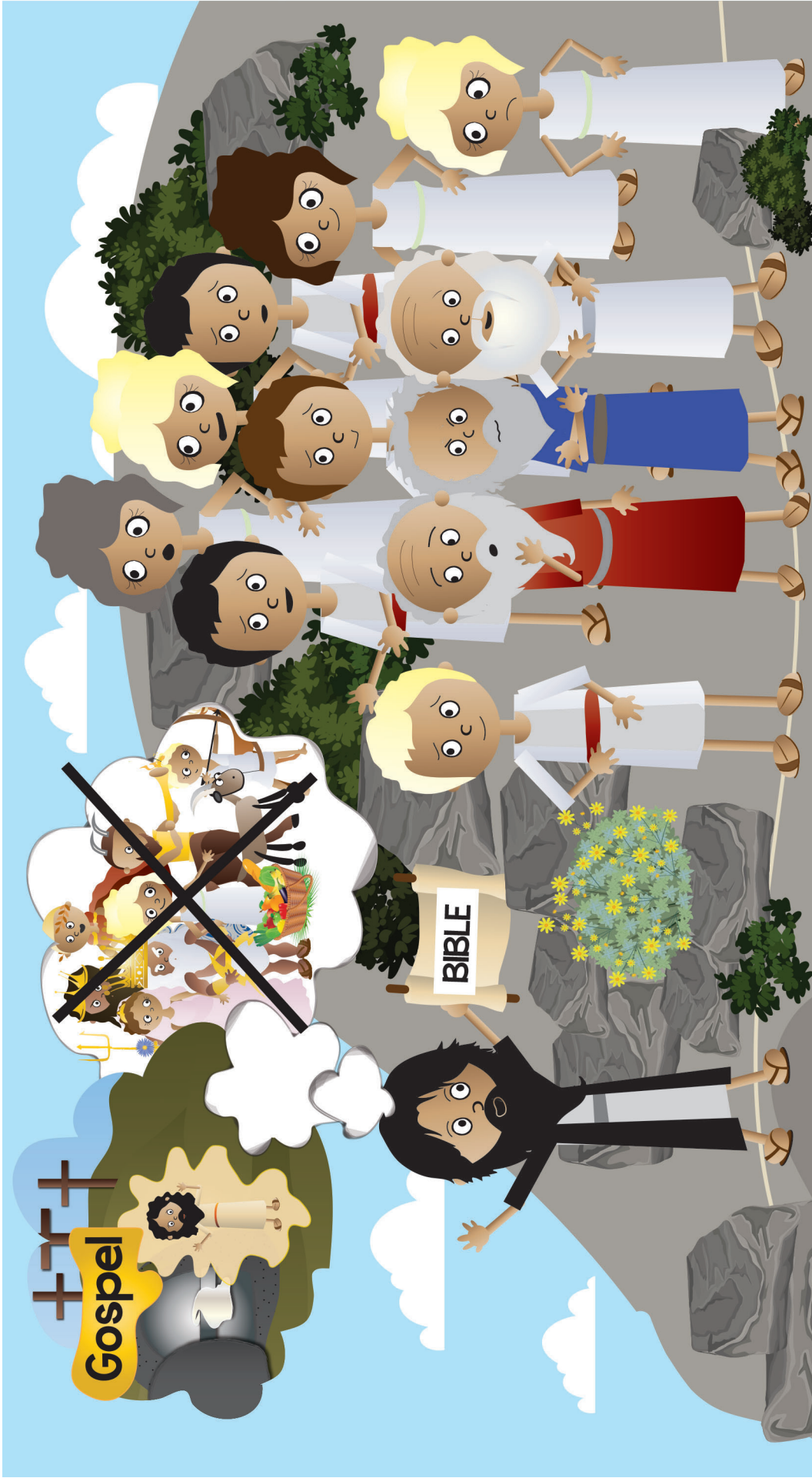

9. So, Paul told the good news of Jesus to all the Gentiles who would listen. “Your gods are fake gods. I’ve come to tell you about the LORD, one, true God!” Paul told them. “HE is the One who created this whole world. He created you. He’s the One who gives you food to eat and all the other things that you enjoy,” Paul explained. “And now, He’s sent His Son, Jesus, to save you from your sins and give you eternal life. Come, know the living God! Turn away from your fake gods and your sins! Put your trust in Jesus and be saved!” Paul exclaimed.

10. Hmmmm... This was very, VERY different from anything these Gentiles had heard before.

Could the LORD be the one, true God? Could Jesus really be His Son, sent to save them? Could they really be forgiven their sins and have eternal life with God?

This was a lot to think about. Would they believe this good news Paul preached this day?

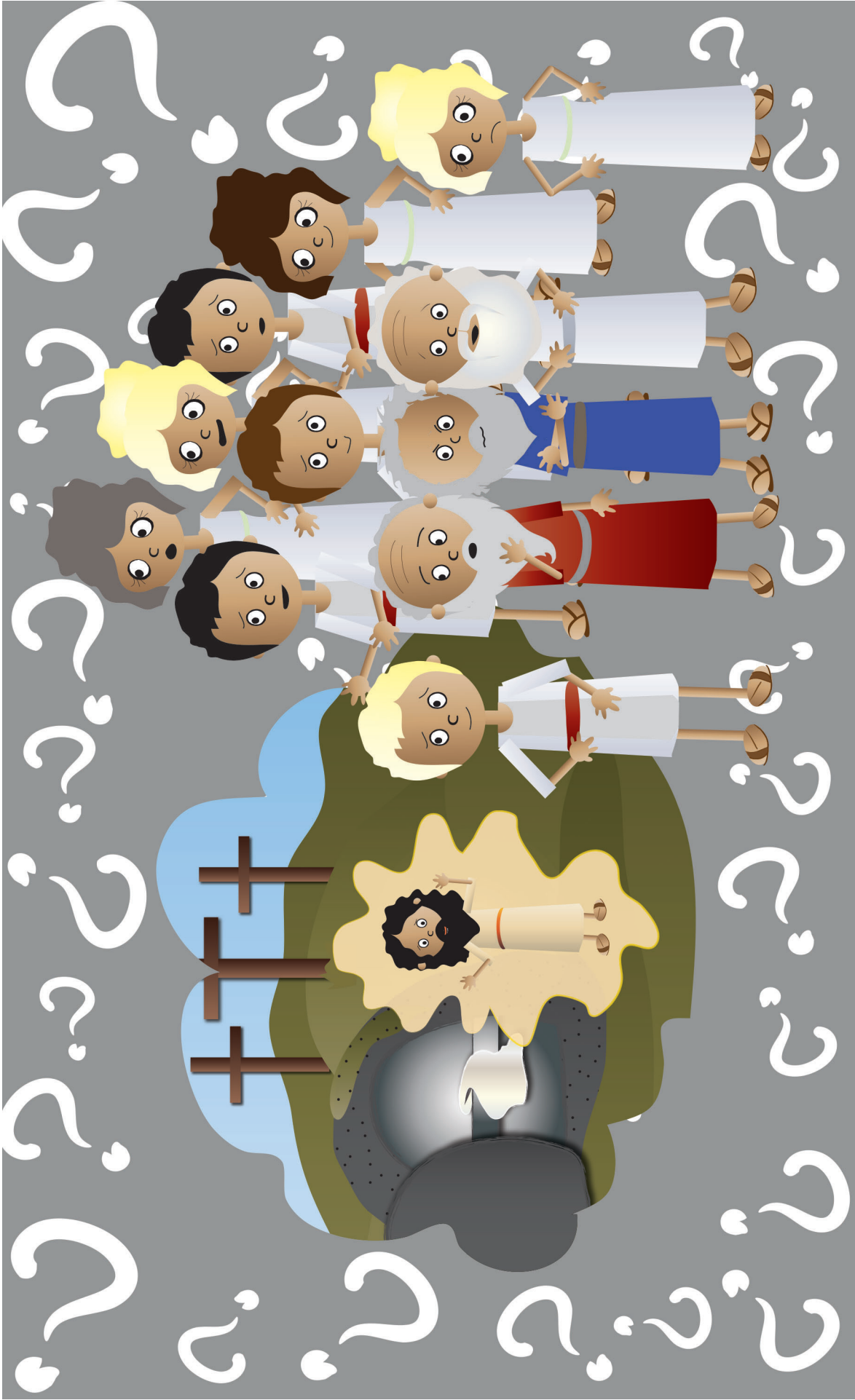

10. Hmmmm... This was very, **VERY** different from anything these Gentiles had heard before. Could the **LORD** be the one, true God? Could Jesus really be His Son, sent to save them? Could they really be forgiven their sins and have eternal life with God? This was a lot to think about. Would they believe this good news Paul preached this day?

II. Yes, they would! The Holy Spirit worked in the hearts of many Gentiles that day.

He helped them turn away from their sins and trust in Jesus as their Savior. He filled their hearts with joy and gave them power to live a new life for God, just He had in the Jewish believers.

How happy these Gentiles were that Jesus had saved them! How much better it was to have the Holy Spirit working inside them, helping them know God and live for Him! How glad they were to be free from worshipping fake gods and trying to find happiness in their old, hopeless way of living. Yay!



II. Yes, they would! The Holy Spirit worked in the hearts of many Gentiles that day. He helped them turn away from their sins and trust in Jesus as their Savior. He filled their hearts with joy and gave them power to live a new life for God, just He had in the Jewish believers. How happy these Gentiles were that Jesus had saved them! How much better it was to have the Holy Spirit working inside them, helping them know God and live for Him! How glad they were to be free from worshipping fake gods and trying to find happiness in their old, hopeless way of living. Yay!

12. These new believers began to gather together to hear God's Word and encourage each other in the wonderful, good news they had come to believe.

Once they had been Jews and Gentiles. Now, they were believers in Jesus, brothers and sisters together in God's family. Soon there were little churches: in Lystra, Derbe, Iconium and other cities-- all over Galatia. How Paul happy was!



12. These new believers began to gather together to hear God's Word and encourage each other in the wonderful, good news they had come to believe. Once they had been Jews and Gentiles. Now, they were believers in Jesus, brothers and sisters together in God's family. Soon there were little churches: in Lystra, Derbe, Iconium and other cities-- all over Galatia. How Paul happy was!

13. Up mountain, down valley. Through forests, along winding rivers, went Paul with Silas again. They were leaving Galatia to tell other people, in other places, the good news of Jesus.

But even though Paul left the land of Galatia far behind, he never forgot the little churches of believers gathering together there. He prayed for them and longed to hear news about them. Oh, how he hoped they were doing well and growing in the Lord!



13. Up mountain, down valley. Through forests, along winding rivers, went Paul with Silas again. They were leaving Galatia to tell other people, in other places, the good news of Jesus. But even though Paul left the land of Galatia far behind, he never forgot the little churches of believers gathering together there. He prayed for them and longed to hear news about them. Oh, how he hoped they were doing well and growing in the Lord!

14. One day, the news Paul was waiting for came. Would it be good news or bad news?

I'm sorry to say that it was BAD news! Things had started out well in the little churches of Galatia, but they had not stayed that way.

Bad teachers had come in. "Paul has it wrong," they told the believers. "Gentiles have to trust in Jesus AND live by the Jews' old laws, if they are to be God's people," they taught.

The believers in the little churches were so confused. Some started believing these bad teachers and began to leave Paul and the good news of Jesus behind! Oh, no!



14. One day, the news Paul was waiting for came. Would it be good news or bad news? I'm sorry to say that it was BAD news! Things had started out well in the little churches of Galatia, but they had not stayed that way. Bad teachers had come in. "Paul has it wrong," they told the believers. "Gentiles have to trust in Jesus AND live by the Jews' old laws, if they are to be God's people," they taught. The believers in the little churches were so confused. Some started believing these bad teachers and began to leave Paul and the good news of Jesus behind! Oh, no!

15. Paul was worried and angry when he heard what was going on. Would everyone in Galatia forget the good news of Jesus? He wanted to protect the little churches from these bad teachers.

Something must be done, and Paul wasted no time in doing it. He sat down and wrote a letter to remind them of the truths he had taught them.

Paul gave the letter to a messenger, and said, "Quick, take this letter to the churches in Galatia!" Then, up mountains, down valleys. Through forests, along winding rivers, the messenger went to take Paul's letter to the Galatians.



15. Paul was worried and angry when he heard what was going on. Would everyone in Galatia forget the good news of Jesus? He wanted to protect the little churches from these bad teachers. Something must be done, and Paul wasted no time in doing it. He sat down and wrote a letter to remind them of the truths he had taught them. Paul gave the letter to a messenger, and said, "Quick, take this letter to the churches in Galatia!" Then, up mountains, down valleys. Through forests, along winding rivers, the messenger went to take Paul's letter to the Galatians.

16. The Galatian Christians gathered together to hear what Paul wrote.

“You foolish Galatians! Don’t listen to those bad teachers!” Paul told them. “Don’t go back to your old way of living! It didn’t make you happy. It didn’t make you right with God, or help you live for Him. No, the fruit of your old life was unhappiness and all kinds of sin!” Paul exclaimed.

“Only faith in Jesus can make you right with God. And, only the Holy Spirit living in your heart can help you know God and live for Him,” Paul reminded them.



16. The Galatian Christians gathered together to hear what Paul wrote. “You foolish Galatians! Don’t listen to those bad teachers!” Paul told them. “Don’t go back to your old way of living! It didn’t make you happy. It didn’t make you right with God, or help you live for Him. No, the fruit of your old life was unhappiness and all kinds of sin!” Paul exclaimed. “Only faith in Jesus can make you right with God. And, only the Holy Spirit living in your heart can help you know God and live for Him,” Paul reminded them.

17. “Go back to the real gospel! Keep trusting in Jesus,” Paul urged the believers.

“And keep in step with the Holy Spirit whom God has put in your hearts! He’s the One who changes you from the inside,” Paul explained.

“The fruit of the Holy Spirit is so different from the fruit of your old way of living. His fruit is love, joy, peace, patience, kindness, and self-control. There will never be a law against the good things that the Holy Spirit gives us! He helps us to keep on living for God.” Paul.



17. "Go back to the real gospel! Keep trusting in Jesus," Paul urged the believers. "And keep in step with the Holy Spirit whom God has put in your hearts! He's the One who changes you from the inside," Paul explained. "The fruit of the Holy Spirit is so different from the fruit of your old way of living. His fruit is love, joy, peace, patience, kindness, and self-control. There will never be a law against the good things that the Holy Spirit gives us! He helps us to keep on living for God." Paul.

18. Would the little churches forget the gospel and fall apart, or would God sustain them? Would the Holy Spirit use Paul's words to help these believers?

Paul learned the answer a few years later he travelled with Timothy and Silas back up the mountains, down the valleys, through the forests, and along the winding rivers to Galatia once more.

He rejoiced to find believers gathering together still. He preached God's Word to them, and the Holy Spirit strengthened their hearts! God had been faithful to sustain His people and He always will be!



18. Would the little churches forget the gospel and fall apart, or would God sustain them? Would the Holy Spirit use Paul's words to help these believers? Paul learned the answer a few years later he travelled with Timothy and Silas back up the mountains, down the valleys, through the forests, and along the winding rivers to Galatia once more. He rejoiced to find believers gathering together still. He preached God's Word to them, and the Holy Spirit strengthened their hearts! God had been faithful to sustain His people and He always will be!

DDD 13.4 Simple Story Scenes

“The Case of the Foolish Forgetters” The Book of Galatians

SOLVED



Detective Dan's Listening Assignment #1

Foolish means doing something without thinking it through well, and something bad happens.

1. Who was foolish? What were they doing without thinking it through well?
The new believers in the church in Galatia. They were obeying new, bad teachers who weren't teaching them the good news of Jesus.
2. What did they forget? They forgot that only by trusting in Jesus could they please God. They forgot that only by the Holy Spirit living in their hearts did they love God and live for Him.

For You and Me:
Like the people of Galatia, we need God's help if we are to live for Him. We can never do this on our own. But the good news is that we don't have to! God promises to forgive all who turn away from their sins and trust in Jesus as their Savior. He promises to give the Holy Spirit to them. He will live in their hearts and help them live for God. Ask God to help you do this! He loves to answer this prayer!



Detective Dan's Listening Assignment #2

2 Corinthians 1:21-22 ESV

“And it is God who establishes us with you in Christ, and has anointed us, and who has also put his seal on us and given us his Spirit in our hearts as a guarantee.”

1. Who did the Galatians forget to depend on to help them live for God?
They forgot to depend on God and the good gifts of salvation and life that He gives them through Jesus.
2. Who did they need to have live in their hearts and help them live for God?
The Holy Spirit.

For You and Me:

Like the people of Galatia, we need God's help if we are to live for Him. We can never do this on our own. But the good news is that we don't have to! God promises to forgive all who turn away from their sins and trust in Jesus as their Savior. He promises to give the Holy Spirit to them. He will live in their hearts and help them live for God. Ask God to help you do this! He loves to answer this prayer!

DDD 13.4 Simple Story Scenes

Why Do God's People Keep Believing in Him?
It Is God's Sustaining Grace!
The Holy Spirit Works Inside of God's People!

The Gospel

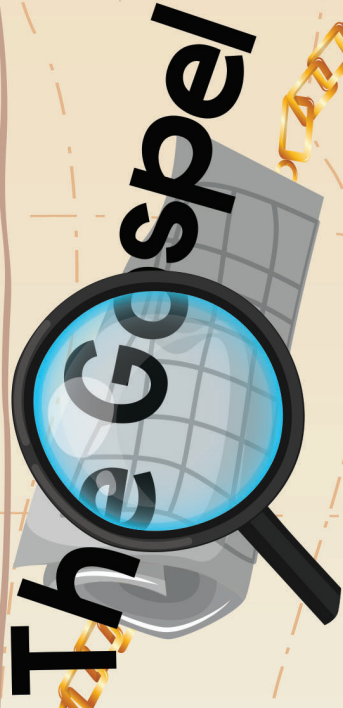

No matter how hard we try, we can never love God or live for Him on our own. We all have chosen to turn away from God and live our own way instead. We deserve God's punishment, not to be His people.

But in His mercy, God sent His Son, Jesus, to be our Savior. Jesus lived a perfect life. Then, on the cross, Jesus gave it as the full payment for the sins of God's people. On Day Three, Jesus rose from the dead. He had really beaten sin and death for them.

Now, all who turn away from their sins and trust in Jesus as their Savior can be God's people. Not only does God forgive their sins, but His Holy Spirit comes to live in their hearts. He helps them love God and live for Him more and more. We can become God's people, too. Ask God to help you! He loves to do this!



DDD 13.4 Simple Story Scenes

A Prayer

A Holy Spirit, we praise You for the way You can powerfully work in our hearts, changing us from the inside out.

C God, we confess that many times we are proud, jealous, envious, and hateful. We need Jesus to save us. We need Your Holy Spirit to replace with humility and love. We need a Savior!

T Thank You, Holy Spirit, for being stronger than any of our sins. Thank You for being able to work powerfully in our hearts and truly change us.

S Holy Spirit, work in our hearts, help us to turn away from our sins and trust in Jesus as our Savior. Fill our heart with Your good ways. Make us joyful, peaceful, kind, patience, self-controlled, joyful, loving, and good. Give us wisdom and make us bold and strong to do God's will.

In Jesus' name we pray. Amen.



DDD 13.4 Simple Story Scenes

DEEP DOWN DETECTIVES



Simple Story Scenes

Unit 13,

Bible Truth 5

Using Simple Story Scenes as a Curriculum

Introduce the Key Concept and Bible Verse

Simple Story Scenes give you the basics for the core of your lesson. You can use the overview sheet to introduce and explain the key concept and Bible verse.

Give the Case Assignment

Give the children a Detective Dan listening assignment. Two are provided. You can add a third using the ideas on the bonus, third take-home sheet, if desired. Each listening assignment, let's you teach the story with a different learning emphasis.

Show & Tell the Story

Hold up the pictures and tell the story from the story scenes. Alternatively, you can find in the and Pieces section for this unit at praisefactory.org, these same listening assignments and story scenes, gospel and ACTS prayer modified for view on a screen. Simply download them or open them online and show through your own monitor (tablet, big screen, whatever).

Solve the Case

Repeat Detective Dan's listening assignment question and discuss the answer.

Share the Gospel

Share the gospel tie-in with the kids.

Close in ACTS Prayer

Pray the ACTS prayer with the kids. If using the curriculum with older children, give them a chance to think up their own ACTS tie-ins to the story, using the one provided as cues/ideas for you.

Review Time

Give out the take-home sheet (there are three: two that correlates to the two Detective Dan assignments in the Story Scenes, and a bonus third one.) As the children are coloring, use the take-home sheet discussion questions or your own questions to further review and apply the key concepts, Bible verse, and story truths to the children.

Looking for more?

Online, in the Bits and Pieces section for this unit, you will find review games, crafts, storyboard flannelgraph figures, and audio and sheet music for all of the songs. There are also full lesson plans that offer more of a script and take this curriculum's possibilities to much more depth. Don't forget to tell the parents about the Parents Resources section where they can read through the Story scenes and download take homes with their kids.

Unit 13: The God Who Sustains

Unit Big Question (and Answer): Why Do God's People Keep Believing in Him? It Is God's Sustaining Grace!

Unit Bible Verse: "Cast your burden on the LORD, and he will sustain you; he will never permit the righteous to be moved." --Psalm 55:22

Bible Truth 5 Concept: It Is God's Sustaining Grace... The Word of God Feeds God's People!

When your body is hungry you feed it food. The food makes your body strong to do what you need it to do. But did you know that the spirit God put inside our bodies needs to be fed, too? Not hamburgers or hot dogs, but a spiritual kind of food.

What is this spiritual food? It's the Word of God, the Bible. When God's people read God's Word, the Holy Spirit uses it to feed their spirits. He uses it to help them know God better, to guide them in God's will, and to give them strength to do whatever God wants them to do.

And just like our bodies work best if we feed them each day, God's people know that it is best for their spirits if they read and think about God's Word every day. They know that God uses His Word to sustain them, even through the most difficult times. We can become God's people, too, when we turn away from our sins and trust in Jesus as our Savior. Then, God will use His Word to help us to keep on loving and living for Him, too.

Bible Truth 5 Bible Verse: Romans 15:4, ESV

"For whatever was written in former days was written for our instruction, that through endurance and through the encouragement of the Scriptures we might have hope."

Learn a Little "Through the encouragement of the Scriptures we have hope."

Meaning

God's Word, the Bible, was written long ago. God made sure everything was written down just right. He wanted His people to be able to trust every promise, and have hope that He would always take care of them and always be working for their good and His glory. He wanted them to read His Word and be instructed--that is, learn--how He wants them to love Him and live for Him.

God's Word may have been written long, long ago, but it still is just as true as ever. God still uses it to give God's people hope. He uses it to help them keep on loving Him and living for Him. He uses it to help them keep looking forward to the day when they will live with Him forever. Read God's Word! He can use it to help you to trust in Him and live for Him, too! He can give you hope!

Bible Truth 5 ACTS Prayer

- A** God, we praise You for being the Giver of Your Word, the Bible.
- C** We confess that many times we don't want to read Your Word or live by it. We need a Savior!
- T** Thank You for promising to use Your Word, the Bible, to strengthen Your people and help them to know You and love You better. Thank You for using it to help them keep on believing in You and living for You.
- S** God, use Your Word to help us to turn away from our sins and trust in Jesus as our Savior. Help us to know You and love You better as we read it. Send Your Holy Spirit to work in our hearts, helping us to understand Your Word and live it out. In Jesus' name we pray, Amen.

Bible Truth 5 Story**The Case of the Confused Christians***Colossians*

Songs Used in Bible Truth 5

Big Q & A 13 Song

Big Question 13 Song: Why Do God's People Keep Believing in Him?

Big Question 13 Bible Verse Song: Cast Your Burden on the LORD Psalm 55:22, ESV

*Extra Big Question 13 Bible Verse Song: Cast Your Burden Psalm 55:22, ESV (other version)**Extra Big Question 13 Bible Verse Song: The LORD Your God Is with You Zephaniah 3:17, NIV 1984*

Big Question 13 Hymn: Jesus Paid It All, v.1

Big Question 13 Praise Song: I Will Sing of the Mercies

Bible Truth 5 Bible Verse: For Whatever Was Written Romans 15:4, ESV

*Bible Truth 5 Extra Bible Verse: He Humbled You Deuteronomy 8:3, ESV**Bible Truth 5 Extra Bible Verse: Take Up the Whole Armor Ephesians 6:13,16-18, ESV*

listen to or download songs for free at <https://praisefactory.org>: Deep Down Detectives Music page

“The Case of the Confused Christians” Colossians



Detective Dan's Listening Assignment #1

1. Where were teachers teaching bad things to believers?
What were the believers confused about?
2. What book could help the believers know the truth?



Detective Dan's Listening Assignment #2

Romans 15:4, ESV

“For whatever was written in former days was written for our instruction, that through endurance and through the encouragement of the Scriptures we might have hope.”

1. What was bad about the teachers in Colossae?
2. What book could the believers read to help them know how to know how to live for God?

(more listening and discussion questions are included in the curriculum at praisefactory.org)

I. Epaphras packed his things, and away he went. Soon, he would be far from his hometown of Colossae.

Why was he leaving home? We don't know exactly. But, we DO know that when Epaphras came back, he was a changed man with a changed life.



I. Epaphras packed his things, and away he went. Soon, he would be far from his hometown of Colossae. Why was he leaving home? We don't know exactly. But, we DO know that when Epaphras came back, he was a changed man with a changed life.

2. Where did these changes happen? Most people think it was in Ephesus, one of the biggest, most beautiful, most important cities in the world back then.

Epaphras would have thought Ephesus was amazing!

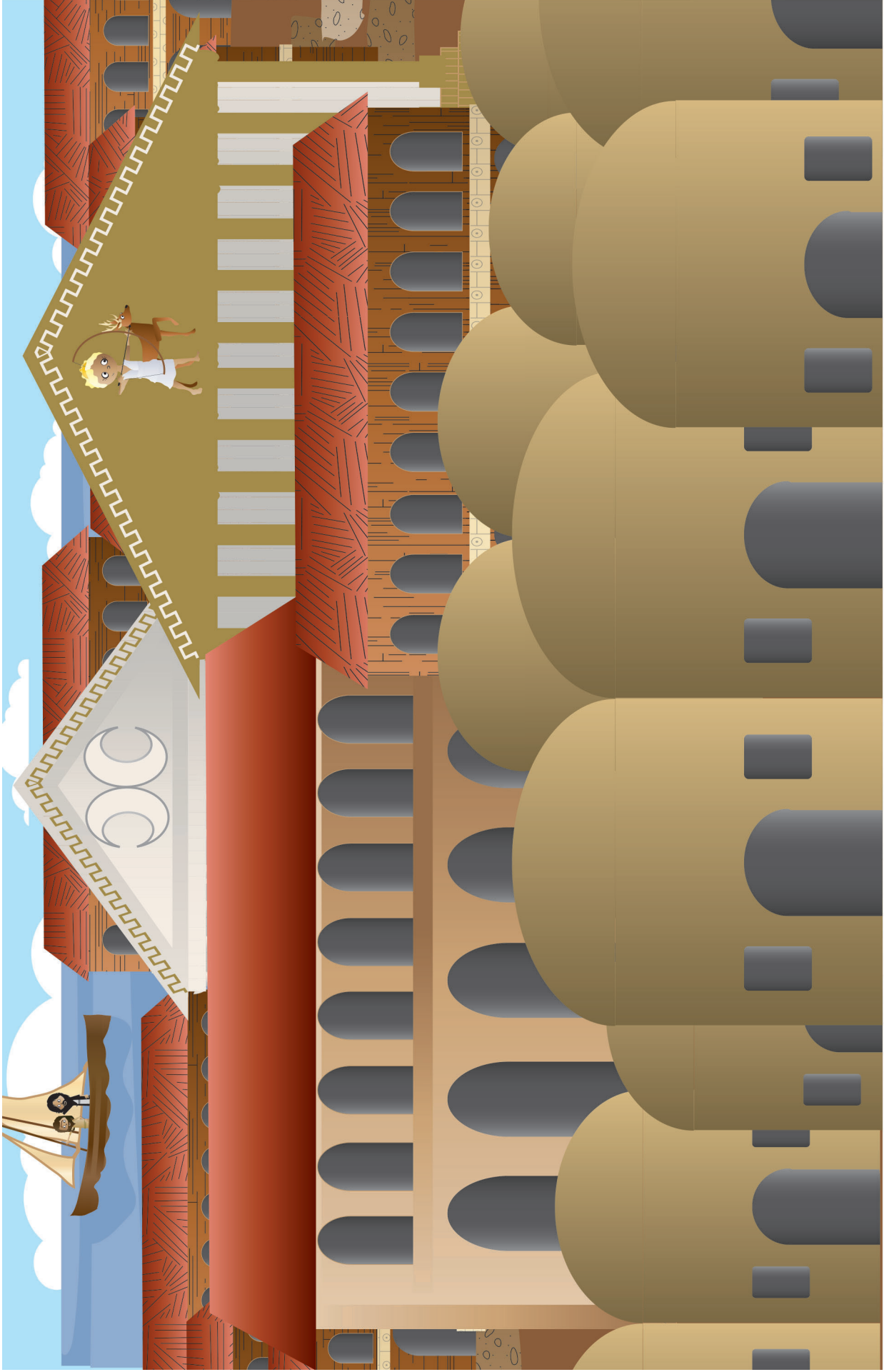

2. Where did these changes happen? Most people think it was in Ephesus, one of the biggest, most beautiful, most important cities in the world back then. Epaphras would have thought Ephesus was amazing!

3. What would Epaphras have seen in Ephesus? He could go to the harbor and see all the ships on the sparkling sea.

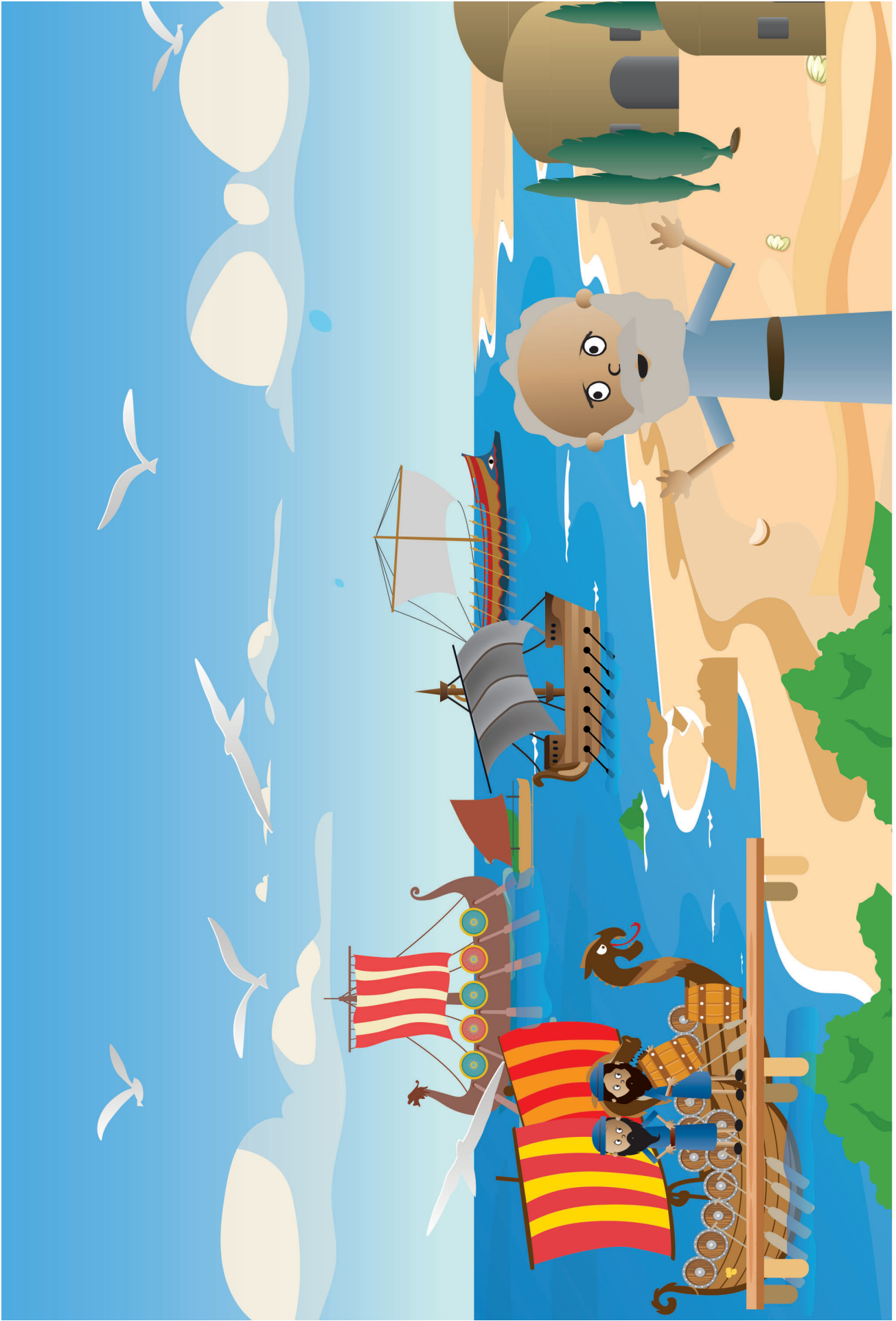

3. What would Epaphras have seen in Ephesus? He could go to the harbor and see all the ships on the sparkling sea.

4. He could walk among crowds of people at the huge marketplace, filled delicious food to eat.

He could “oohh and ahh” over the beautiful things for sale that sellers from around the world brought in by ship, by donkey, and camel.



4. He could walk among crowds of people at the huge marketplace, filled delicious food to eat. He could “oohh and ahh” over the beautiful things for sale that sellers from around the world brought in by ship, by donkey, and camel.

5. And most amazing of all, he could see the magnificent, golden worship place of Artemis, the great goddess of the Ephesians.

Her temple towered over the city and shone out like a glittering jewel. It was one of the most beautiful buildings in the world.

Big city! Good food! Rich things! Glorious worship place! What an exciting trip Epaphras was making! What could be better than this?



Artemis

5. And most amazing of all, he could see the magnificent, golden worship place of Artemis, the great goddess of the Ephesians. Her temple towered over the city and shone out like a glittering jewel. It was one of the most beautiful buildings in the world. Big city! Good food! Rich things! Glorious worship place! What an exciting trip Epaphras was making! What could be better than this?

6. Now, perhaps Epaphras couldn't think of finding anything better than these wonderful things in Ephesus, but there WAS something far better coming.

You see, someone ELSE was also on his way to Ephesus, just like Epaphras. And this someONE was bringing someTHING that Epaphras would want more than Ephesus' best-tasting food.. SOMETHING he would find worth more than any of the beautiful things for sale... SOMETHING even far more glorious than the glittery golden worship place of Artemis!

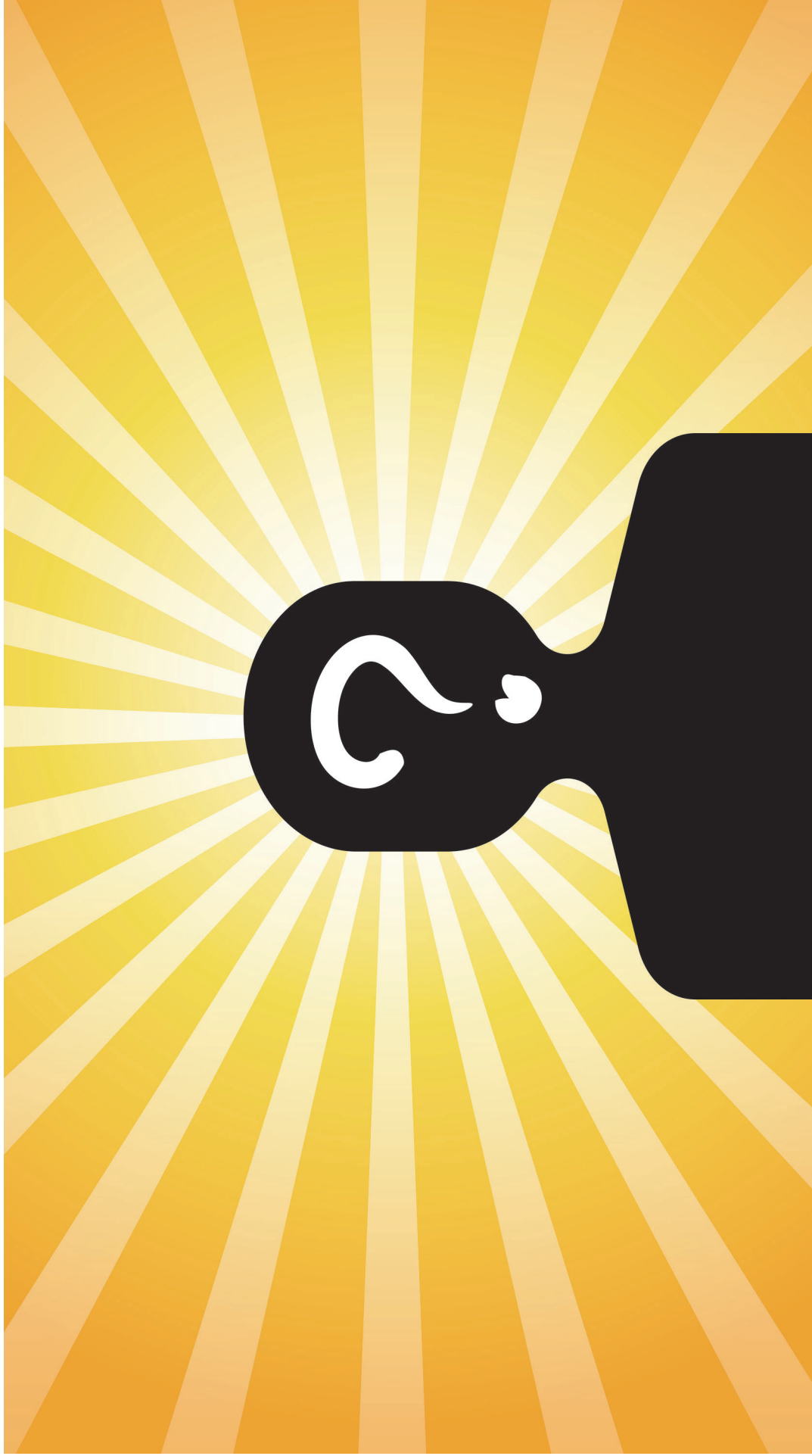

6. Now, perhaps Epaphras couldn't think of finding anything better than these wonderful things in Ephesus, but there WAS something far better coming. You see, someone ELSE was also on his way to Ephesus, just like Epaphras. And this someONE was bringing someTHING that Epaphras would want more than Ephesus' best-tasting food... SOMETHING he would find worth more than any of the beautiful things for sale... SOMETHING even far more glorious than the glittery golden worship place of Artemis!

7. Paul was the SOMEONE making his way to Ephesus. And the very special SOMETHING he was bringing with him was the Bible, God's Word.

Yes, God was about to use His Word and Paul to change Epaphras' life completely!



7. Paul was the **SOMEONE** making his way to Ephesus. And the very special **SOMETHING** he was bringing with him was the Bible, God's Word. Yes, God was about to use His Word and Paul to change Epaphras' life completely!

8. In the mornings, Paul joined the other buyers and sellers in the marketplace.

Some people sold cloth. Some sold food. Others sold little statues of the goddess Artemis. Paul made and sold tents.

Selling tents was how Paul made his living, but it was ALSO a great way to talk to people about God's Word and the Savior, Jesus. Some were only interested in Paul's tents, but others were interested in Paul's good news.



8. In the mornings, Paul joined the other buyers and sellers in the marketplace. Some people sold cloth. Some sold food. Others sold little statues of the goddess Artemis. Paul made and sold tents. Selling tents was how Paul made his living, but it was ALSO a great way to talk to people about God's Word and the Savior, Jesus. Some were only interested in Paul's tents, but others were interested in Paul's good news.

9. So, every afternoon, after lunch, while many Ephesians took naps, Paul preached from God's Word in a nearby schoolroom called the Hall of Tyrannus.

Epaphras, along with others, must have found his way into Paul's classes on one of these lazy afternoons.



9. So, every afternoon, after lunch, while many Ephesians took naps, Paul preached from God's Word in a nearby schoolroom called the Hall of Tyrannus. Epaphras, along with others, must have found his way into Paul's classes on one of these lazy afternoons.

10. “God promised in the His Word to send a Savior to save His people from their sins. That Savior is Jesus,” Paul taught the people who gathered.

“Jesus died on the cross, suffering for their sins in their place. He rose from the grave on the third day, proving He had really beaten sin and death for God’s people,” Paul told them.

“Turn away from your sins and trust in Jesus as your Savior, and you will be saved. This is how you can become God’s people!” Paul urged everyone.



10. "God promised in the His Word to send a Savior to save His people from their sins. That Savior is Jesus," Paul taught the people who gathered. "Jesus died on the cross, suffering for their sins in their place. He rose from the grave on the third day, proving He had really beaten sin and death for God's people," Paul told them. "Turn away from your sins and trust in Jesus as your Savior, and you will be saved. This is how you can become God's people!" Paul urged everyone.

II. As Epaphras listened, God's Holy Spirit worked powerfully in his heart.

Epaphras believed God's Word. He turned away from his sins and trusted in Jesus as his Savior. Epaphras' life was completely changed!



II. As Epaphras listened, God's Holy Spirit worked powerfully in his heart. Epaphras believed God's Word. He turned away from his sins and trusted in Jesus as his Savior. Epaphras' life was completely changed!

12. Epaphras didn't just listen to Paul preach God's Word once. He learned from him over and over again.

Epaphras wanted to learn everything he could from God's Word. He was learning for himself, AND for others, too: the people back home in Colossae!



12. Epaphras didn't just listen to Paul preach God's Word once. He learned from him over and over again. Epaphras wanted to learn everything he could from God's Word. He was learning for himself, AND for others, too: the people back home in Colossae!

13. There were two kinds of people in Colossae --Jews and Gentiles - and they all needed to hear what Epaphras was learning.

The Jews in Colossae had God's Word already, but they didn't understand God's promises that Jesus would be the Savior. They kept trying to please God by just keeping His laws.

That would never work! They could never save themselves! How these Jews needed to hear about God's free gift of salvation through Jesus!

God's Laws

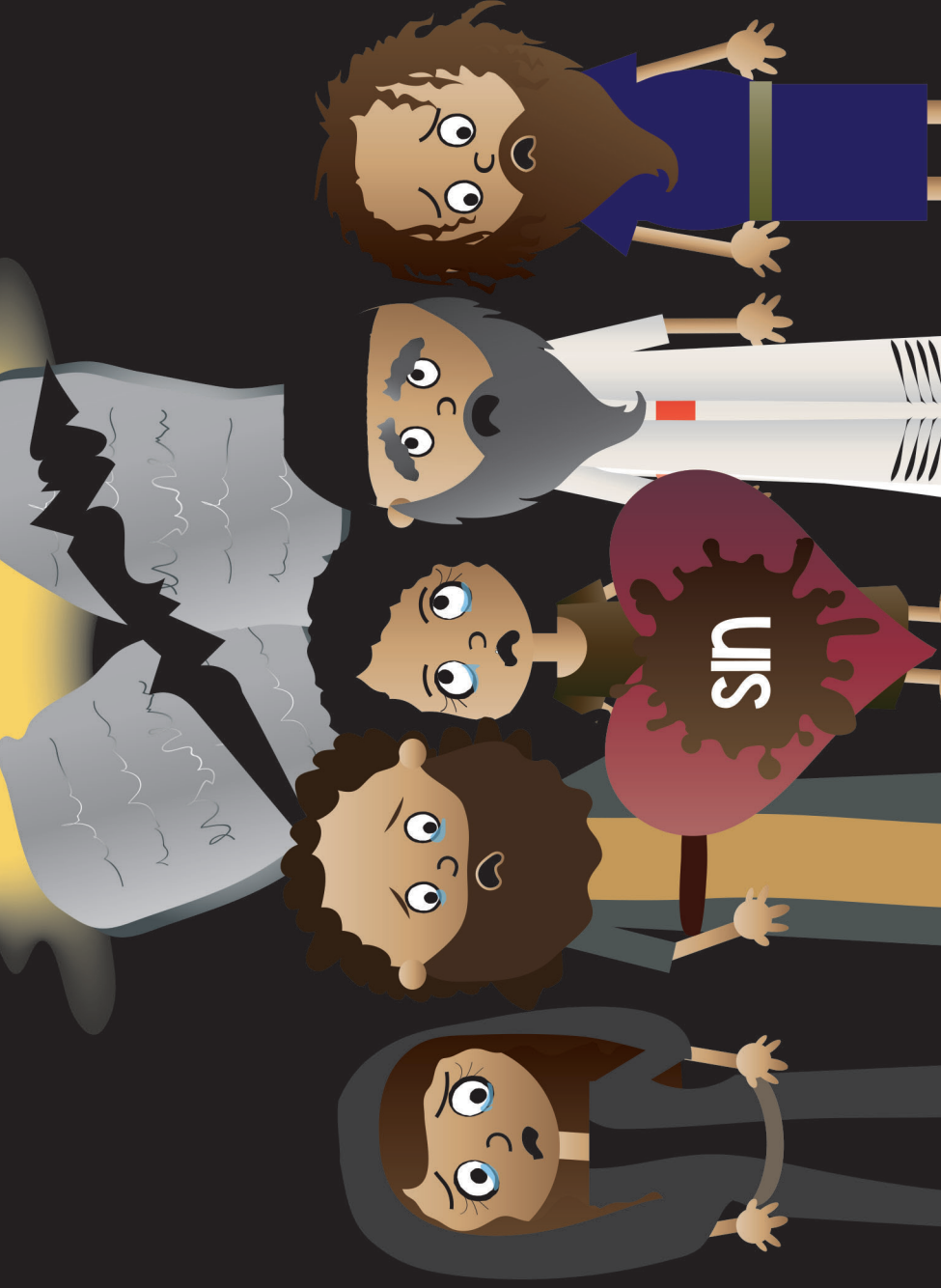

13. There were two kinds of people in Colossae -- Jews and Gentiles - and they all needed to hear what Epaphras was learning. The Jews in Colossae had God's Word already, but they didn't understand God's promises that Jesus would be the Savior. They kept trying to please God by just keeping His laws. That would never work! They could never save themselves! How these Jews needed to hear about God's free gift of salvation through Jesus!

14. The Gentiles in Colossae needed to hear what Epaphras was learning, too.

Epaphras was a Gentile like them. He knew all about the fake gods they worshipped and feared. He knew about the necklaces of stones the Gentiles believed had magical powers to protect them from bad things.

Oh, how these Gentiles needed to hear about the LORD, the one, true God. Oh, how they needed to hear about Jesus, God's mighty Son, who broke the power of sin and death! How Epaphras wanted to see them free of their fear and these fake gods!

Fake Gods



Magical Necklaces

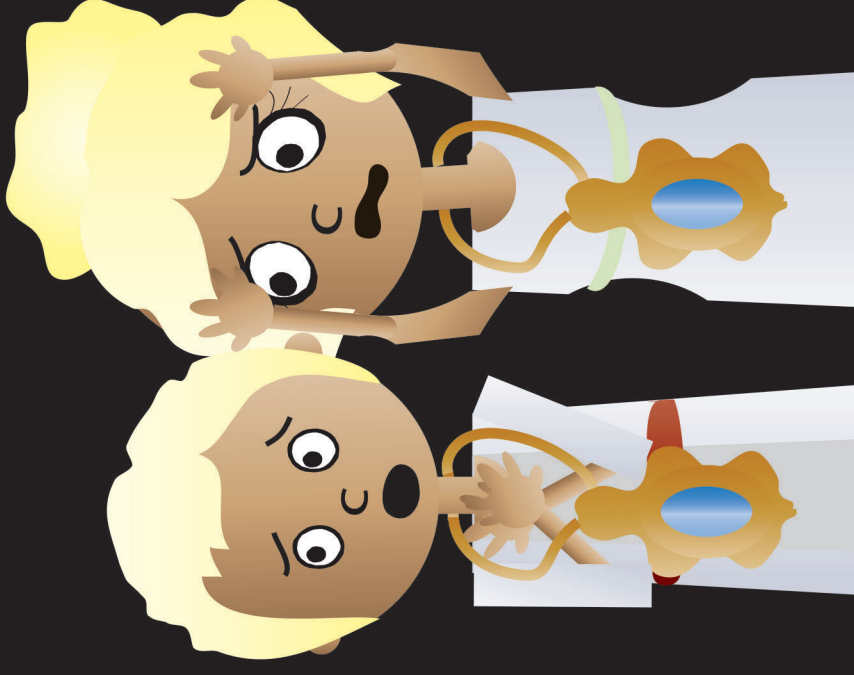

14. The Gentiles in Colossae needed to hear what Epaphras was learning, too. Epaphras was a Gentile like them. He knew all about the fake gods they worshipped and feared. He knew about the necklaces of stones the Gentiles believed had magical powers to protect them from bad things. Oh, how these Gentiles needed to hear about the LORD, the one, true God. Oh, how they needed to hear about Jesus, God's mighty Son, who broke the power of sin and death! How Epaphras wanted to see them free of their fear and these fake gods!

15. So, Epaphras said goodbye to Paul and headed back home with his exciting message. Away from the sea, back up through the mountains to Colossae, he went.

Epaphras spread his good news to all who would listen, both Jew and Gentile. "God promised in His Word to send a Savior to save His people from their sins. That Savior is Jesus," Epaphras told them.

"Jesus died on the cross, suffering for the sins of God's people, so they wouldn't have to."

"Then on the third day, Jesus rose up from the grave, showing that He had really beaten sin and death for God's people," Epaphras exclaimed.



15. So, Epaphras said goodbye to Paul and headed back home with his exciting message. Away from the sea, back up through the mountains to Colossae, he went. Epaphras spread his good news to all who would listen, both Jew and Gentile. “God promised in His Word to send a Savior to save His people from their sins. That Savior is Jesus,” Epaphras told them. “Jesus died on the cross, suffering for the sins of God’s people, so they wouldn’t have to. Then on the third day, Jesus rose up from the grave, showing that He had really beaten sin and death for God’s people,” Epaphras exclaimed.

16. “Turn away from your sins and trust in Jesus as your Savior, and you will be saved! This is how you can become God’s people!” Epaphras urged them all.

What would the Jews think? What would the Gentiles think? Would they believe Epaphras’ good news from God’s Word?



16. “Turn away from your sins and trust in Jesus as your Savior, and you will be saved! This is how you can become God’s people!” Epaphras urged them all. What would the Jews think? What would the Gentiles think? Would they believe Epaphras’ good news from God’s Word?

17. The Holy Spirit worked in many hearts as Epaphras preached from God's Word. He helped the Jews believe that Jesus was the Savior God had promised to send.

They stopped trusting in how well they could obey God's laws, and trusted in Jesus as their Savior.



17. The Holy Spirit worked in many hearts as Epaphras preached from God's Word. He helped the Jews believe that Jesus was the Savior God had promised to send. They stopped trusting in how well they could obey God's laws, and trusted in Jesus as their Savior.

18. The Holy Spirit worked in the hearts of the Gentiles, too.

They stopped worshipping their fake gods. They stopped trusting in their magical necklaces. They stopped fearing what bad things might happen to them.

They turned away from their sins and trusted in God's mighty Son, Jesus, as their Savior. How happy was Epaphras!



18. The Holy Spirit worked in the hearts of the Gentiles, too. They stopped worshipping their fake gods. They stopped trusting in their magical necklaces. They stopped fearing what bad things might happen to them. They turned away from their sins and trusted in God's mighty Son, Jesus, as their Savior. How happy was Epaphras!

19. Now, there were believers in Colossae. A whole, little church!

How Epaphras loved these new believers in Colossae! He spent long hours in prayer for them. And each week, as they gathered together, Epaphras taught them from the Bible.

Epaphras knew these believers needed to keep on learning God's Word if they were to keep on loving God and living for Him. He knew the Holy Spirit would use God's Word to help these new believers to fight sin and grow stronger in their faith, just like He was helping him.



19. Now, there were believers in Colossae. A whole, little church! How Epaphras loved these new believers in Colossae! He spent long hours in prayer for them. And each week, as they gathered together, Epaphras taught them from the Bible. Epaphras knew these believers needed to keep on learning God's Word if they were to keep on loving God and living for Him. He knew the Holy Spirit would use God's Word to help these new believers to fight sin and grow stronger in their faith, just like He was helping him.

20. And oh, how they needed all the help they could get!

Sometimes, the Jewish believers were tempted to go back to trusting in keeping God's laws again!

And sometimes, the Gentiles believers were tempted to go back to trusting in fake magical stones to keep them safe!

God's Laws



Magical Necklaces

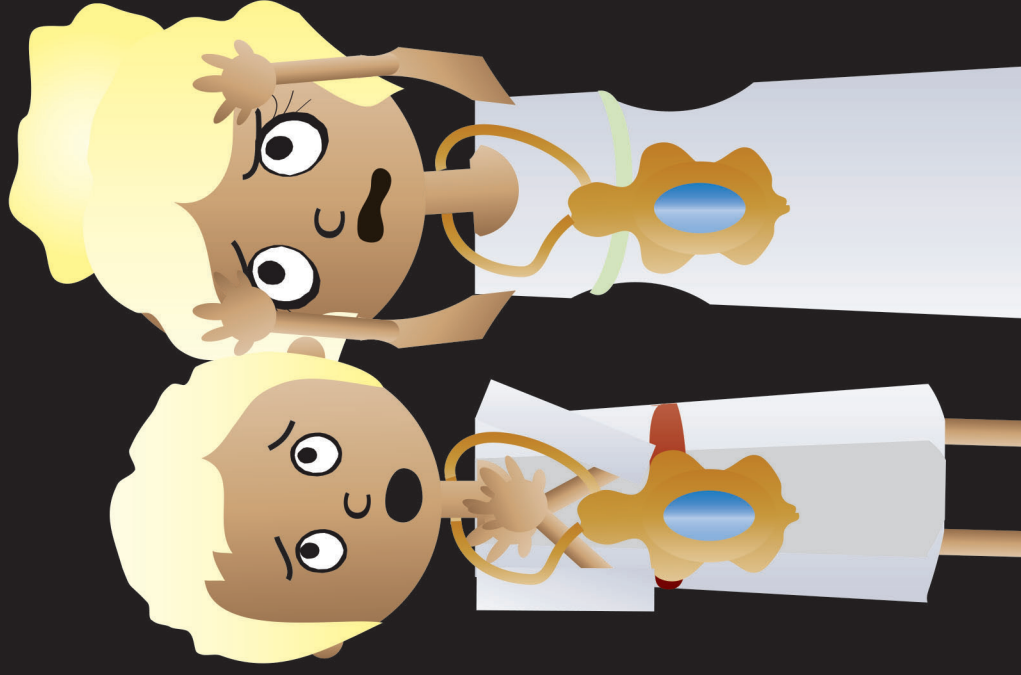

20. And oh, how they needed all the help they could get! Sometimes, the Jewish believers were tempted to go back to trusting in keeping God's laws again! And sometimes, the Gentiles believers were tempted to go back to trusting in fake magical stones to keep them safe!

21. Then, bad teachers came to the little church and made things much worse.

“Jesus isn’t enough,” they taught the believers. “You need to keep those old laws, too. ‘Don’t eat this food,’ ‘Don’t touch that bad thing!’ and other laws like that,” they insisted.

“Jesus isn’t enough to protect you from bad things, either. Put that magical stone back on your neck. Call on angels to help you,” they urged the believers.

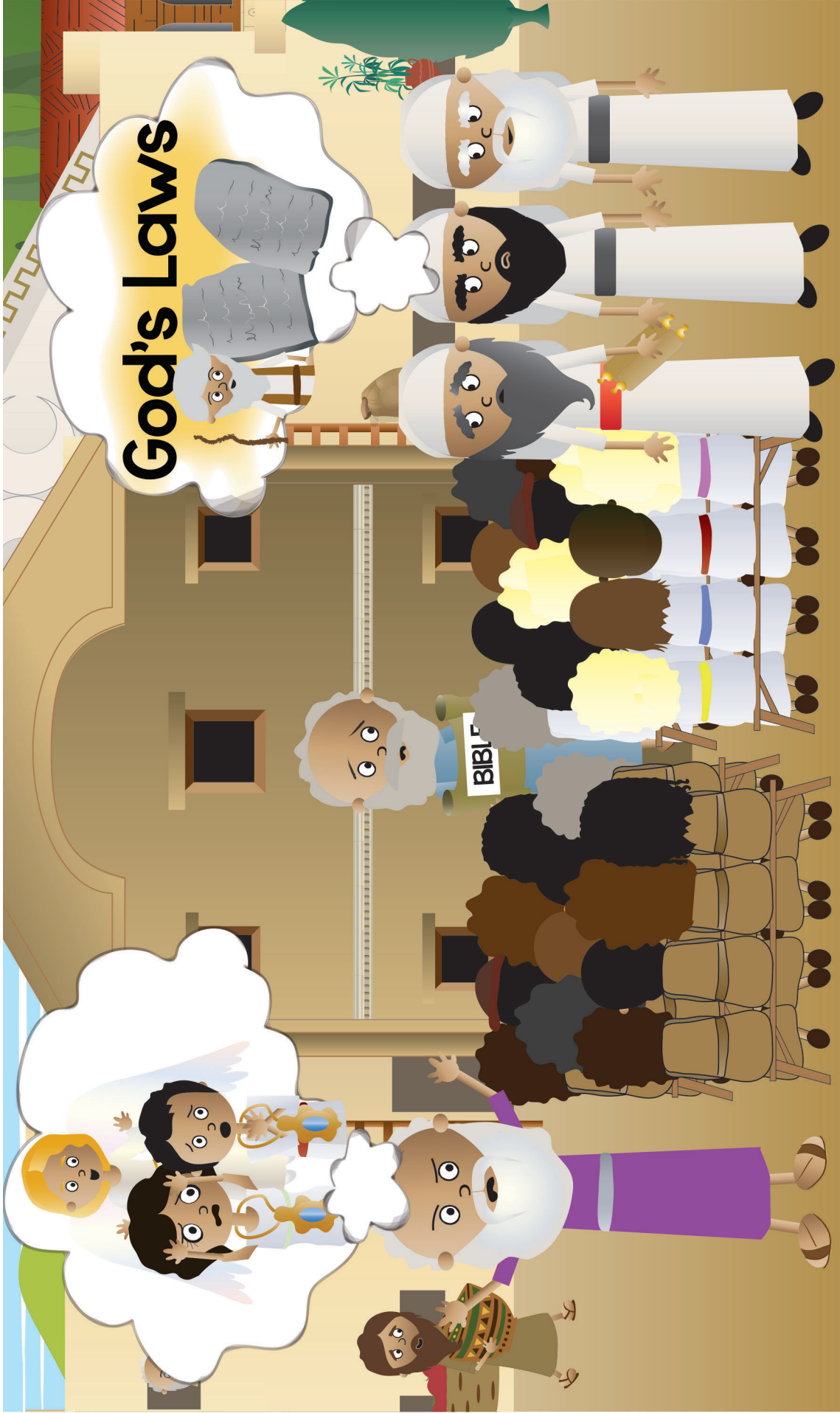

21. Then, bad teachers came to the little church and made things much worse. “Jesus isn’t enough,” they taught the believers. “You need to keep those old laws, too. ‘Don’t eat this food,’ ‘Don’t touch that bad thing!’ and other laws like that,” they insisted. “Jesus isn’t enough to protect you from bad things, either. Put that magical stone back on your neck. Call on angels to help you,” they urged the believers.

22. “No! No! No!” exclaimed Epaphras. “Jesus is enough!” he told them.

The believers were confused and so scared. Heeeelp!!! What should they do? Who could help them?

Epaphras knew! The same man who had taught him from God’s Word in the first place. Can you remember his name? It was Paul! Epaphras would get help from Paul. Maybe the believers would listen to this godly leader.

But uh, oh... Paul wasn’t in Ephesus anymore. He was over a thousand miles away in prison in Rome. Paul had gotten in trouble for telling people about Jesus and been thrown in jail as punishment.



22. "No! No! No!" exclaimed Epaphras. "Jesus IS enough!" he told them. The believers were confused and so scared. Heeeelp!!!! What should they do? Who could help them? Epaphras knew! The same man who had taught him from God's Word in the first place. Can you remember his name? It was Paul! Epaphras would get help from Paul. Maybe the believers would listen to this godly leader. But uh, oh.... Paul wasn't in Ephesus anymore. He was over a thousand miles away in prison in Rome. Paul had gotten in trouble for telling people about Jesus and been thrown in jail as punishment.

23. Now, a thousand miles away may not seem like a big deal to you, but it was back then. There were no phones, computers, cars, airplanes, or any other quick way to talk to someone who lived faraway like there is today.

No, if Epaphras wanted Paul's help, he would have to go to him to get it. It would take Epaphras weeks to get to Rome. What a long, hard trip!

But Epaphras loved the Lord, and he loved these new believers in Colossae. He would do whatever it took to help them. So, all the way to Rome, Epaphras went to find Paul.



23. Now, a thousand miles away may not seem like a big deal to you, but it was back then. There were no phones, computers, cars, airplanes, or any other quick way to talk to someone who lived faraway like there is today. No, if Epaphras wanted Paul's help, he would have to go to him to get it. It would take Epaphras weeks to get to Rome. What a long, hard trip! But Epaphras loved the Lord, and he loved these new believers in Colossae. He would do whatever it took to help them. So, all the way to Rome, Epaphras went to find Paul.

24. Epaphras found Paul in his little prison house in Rome, and he shared everything that had happened in Colossae.

There was so much good news: many Jews and Gentiles had become believers and were growing under the preaching of God's Word.

But there was bad news, too. Epaphras told Paul about the bad teachers who had come and were confusing the believers. What would happen to the little church in Colossae if these bad teachers kept on causing trouble? What could be done?



24. Epaphras found Paul in his little prison house in Rome, and he shared everything that had happened in Colossae. There was so much good news: many Jews and Gentiles had become believers and were growing under the preaching of God's Word. But there was bad news, too. Epaphras told Paul about the bad teachers who had come and were confusing the believers. What would happen to the little church in Colossae if these bad teachers kept on causing trouble? What could be done?

25. How helpful Paul was! He shared his wisdom with Epaphras, and he prayed for the church in Colossae. But best of all, Paul sat down and wrote a letter for Epaphras to take back to the believers in Colossae.

How happy Epaphras was to have Paul's letter! He hoped it would be just the encouragement the believers needed. Letter in hand, he headed home to Colossae.



25. How helpful Paul was! He shared his wisdom with Epaphras, and he prayed for the church in Colossae. But best of all, Paul sat down and wrote a letter for Epaphras to take back to the believers in Colossae. How happy Epaphras was to have Paul's letter! He hoped it would be just the encouragement the believers needed. Letter in hand, he headed home to Colossae.

26. When he got home, Epaphras gathered the believers together and read them Paul's words:

**“Dear Believers in Colossae,
I've not met you, but I've been praying for you!**

Epaphras told me how you heard the Word of truth about Jesus and believed. I'm praying that you will go on growing in the truths you've learned.

This is how God will help you know Him better and give you strength to keep on living for God, like He wants you to,” Paul wrote.



26. When he got home, Epaphras gathered the believers together and read them Paul's words: "Dear Believers in Colossae, I've not met you, but I've been praying for you! Epaphras told me how you heard the Word of truth about Jesus and believed. I'm praying that you will go on growing in the truths you've learned. This is how God will help you know Him better and give you strength to keep on living for God, like He wants you to," Paul wrote.

27. “You don’t need to go back to the old laws you used to keep. You don’t need wear magical stones to be safe! Jesus kept the God’s laws perfectly for you. He broke the power of sin and death when He died on the cross,” Paul told them.

“So, keep on remembering what you’ve learned about Jesus from God’s Word. Let it soak deep down in your hearts and minds.

Help each other remember these things by teaching them to each other and singing them in your worship songs. Keep on trusting in Jesus.

And in everything you do, do it all to honor Jesus, giving thanks to God. May God’s power be at work in you, Paul.”



27. “You don’t need to go back to the old laws you used to keep. You don’t need wear magical stones to be safe! Jesus kept the God’s laws perfectly for you. He broke the power of sin and death when He died on the cross,” Paul told them. “So, keep on remembering what you’ve learned about Jesus from God’s Word. Let it soak deep down in your hearts and minds. Help each other remember these things by teaching them to each other and singing them in your worship songs. Keep on trusting in Jesus. And in everything you do, do it all to honor Jesus, giving thanks to God. May God’s power be at work in you, Paul.”

28. Some of the believers in Colossae kept struggling with what the bad teachers said, but, many heard Paul's words and were helped.

They would depend on what God's Word told them about Jesus and everything else to give them what they needed to keep on loving God and living for Him.

And God would be faithful to help them! He always is!

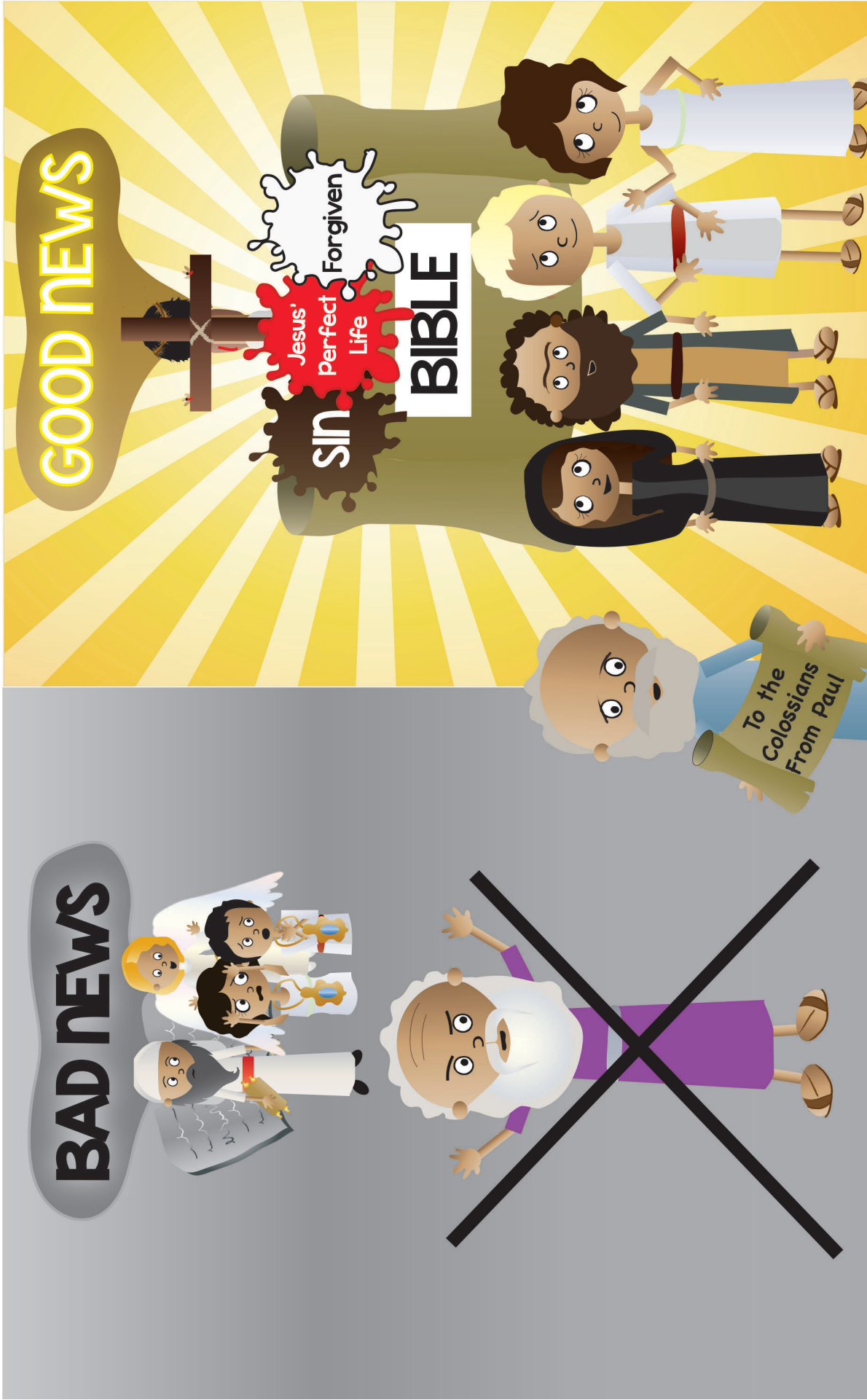

28. Some of the believers in Colossae kept struggling with what the bad teachers said, but, many heard Paul's words and were helped. They would depend on what God's Word told them about Jesus and everything else to give them what they needed to keep on loving God and living for Him. And God would be faithful to help them! He always is!

DDD 13.5 Simple Story Scenes

“The Case of the Confused Christians” Colossians

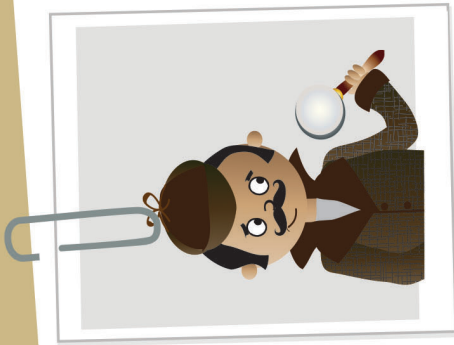

Detective Dan's Listening Assignment #1

1. Where were teachers teaching bad things to the believers? What were the believers confused about? Colossae. They were teaching the believers to go back to the old, bad ways of living, like keeping special rules and using magic stones.
2. What book could help the believers know the truth? God's Word, the Bible.

For You and Me:
Like the believers in Colossae, we can turn to God's Word, the Bible, to know what is true. There, we can read about Jesus. There, we can learn how to turn away from our sins and trust in Him as our Savior. And there, God can continue to teach us more of His truth and make us strong to live for Him.



Detective Dan's Listening Assignment #2

Romans 15:4, ESV

“For whatever was written in former days was written for our instruction, that through endurance and through the encouragement of the Scriptures we might have hope.”

1. What was bad about the teachers in Colossae? They were teaching the believers to go back to the old, bad ways of living, like keeping special rules and using magic stones.
2. What book could the believers read to help them know how to know how to live for God? God's Word, the Bible.

For You and Me:

Like the believers in Colossae, we can turn to God's Word, the Bible to know what is true. There, we can read about Jesus. There, we can learn how to turn away from our sins and trust in Him as our Savior. And there, God can continue to teach us more of His truth and make us strong to live for Him.

DDD 13.5 Simple Story Scenes

Why Do God's People Keep Believing in Him?
It Is God's Sustaining Grace...
The Word of God Feeds God's People!

The Gospel



There is so much to love about the Bible, God's Word! Through it, we can learn the truth about God and about ourselves. We learn that we have all chosen to disobey God and deserve His punishment. How sad!

But God's Word also tells us about God's mercy in sending Jesus, His Son, to be the Savior we need. It tells us that Jesus lived a perfect life; then on the cross, He gave it up to pay for the sins of God's people. On the third day, Jesus rose from the dead. He had really beaten sin and death for them!

Best of all, the Bible tells us that now, whoever turns away from their sins and trust in Jesus as their Savior can become God's people. Their sins are forgiven. They get to know God in their hearts, now. God will use His Word to help them know Him better and live for Him. Then, one day, they will go live with Him forever.

Ask God to help you
become one of
His people.
He loves to
help us!



DDD 13.5 Simple Story Scenes

A Prayer

A God, we praise You for being the Giver of Your Word, the Bible.

C We confess that many times we don't want to read Your Word or live by it. We need a Savior!

T Thank You for promising to use Your Word, the Bible, to strengthen Your people and help them to know You and love You better. Thank You for using it to help them keep on believing in You and living for You.

S God, use Your Word to help us to turn away from our sins and trust in Jesus as our Savior. Help us to know You and love You better as we read it. Send Your Holy Spirit to work in our hearts, helping us to understand Your Word and live it out.

In Jesus' name we pray, Amen.



DDD 13.5 Simple Story Scenes

DEEP DOWN DETECTIVES



Simple Story Scenes

Unit 13,

Bible Truth 6

Using Simple Story Scenes as a Curriculum

Introduce the Key Concept and Bible Verse

Simple Story Scenes give you the basics for the core of your lesson. You can use the overview sheet to introduce and explain the key concept and Bible verse.

Give the Case Assignment

Give the children a Detective Dan listening assignment. Two are provided. You can add a third using the ideas on the bonus, third take-home sheet, if desired. Each listening assignment, let's you teach the story with a different learning emphasis.

Show & Tell the Story

Hold up the pictures and tell the story from the story scenes. Alternatively, you can find in the and Pieces section for this unit at praisefactory.org, these same listening assignments and story scenes, gospel and ACTS prayer modified for view on a screen. Simply download them or open them online and show through your own monitor (tablet, big screen, whatever).

Solve the Case

Repeat Detective Dan's listening assignment question and discuss the answer.

Share the Gospel

Share the gospel tie-in with the kids.

Close in ACTS Prayer

Pray the ACTS prayer with the kids. If using the curriculum with older children, give them a chance to think up their own ACTS tie-ins to the story, using the one provided as cues/ideas for you.

Review Time

Give out the take-home sheet (there are three: two that correlates to the two Detective Dan assignments in the Story Scenes, and a bonus third one.) As the children are coloring, use the take-home sheet discussion questions or your own questions to further review and apply the key concepts, Bible verse, and story truths to the children.

Looking for more?

Online, in the Bits and Pieces section for this unit, you will find review games, crafts, storyboard flannelgraph figures, and audio and sheet music for all of the songs. There are also full lesson plans that offer more of a script and take this curriculum's possibilities to much more depth. Don't forget to tell the parents about the Parents Resources section where they can read through the Story scenes and download take homes with their kids.

Unit 13: The God Who Sustains

Unit Big Question (and Answer): Why Do God's People Keep Believing in Him? It Is God's Sustaining Grace!

Unit Bible Verse: "Cast your burden on the LORD, and he will sustain you; he will never permit the righteous to be moved." --Psalm 55:22

Bible Truth 6 Concept: It Is God's Sustaining Grace... God Uses His People to Strengthen and Comfort Each Other!

No matter who we are, we all go through times of need. Sometimes, we are learning something new, and we need help learning how to do it. Sometimes, we are going through something that is very sad or very hard, and we need comfort and strength. God loves to help His people all the time, especially in their times of need. He uses His Word, the Bible, to guide and comfort them. His Holy Spirit strengthens them inside their heart. But God also helps His people through their prayers and comfort for each other.

God's people comfort each other by reminding one another that God is always with them and how great and good He is. They read the Bible to each other and hold on to His wonderful promises to take care of them. They pray for each other, asking God to give them wisdom, strength, and joy; and, to rescue them from their troubles. They ask God to use their hard and sad times for their good and to bring glory to His name.

God loves to sustain His people through their comfort and prayers for one another. It is a wonderful display of His love both to His people and to others who watch how God's people love and care for one another. We, too, can become God's people when we turn from our sins and trust in Jesus as our Savior. Then, He can use us to comfort others in this special way, too.

Bible Truth 6 Bible Verse: 2 Corinthians 1:3-4,10-11, ESV

"Blessed be the God and Father of our Lord Jesus Christ, the Father of mercies and God of all comfort, who comforts us in all our affliction, so that we may be able to comfort those who are in any affliction, with the comfort with which we ourselves are comforted by God...On him we have set our hope that he will deliver us again. You also must help us by prayer, so that many will give thanks on our behalf for the blessing granted us through the prayers of many."

Learn a Little: "We comfort those in any affliction, with the comfort we are comforted by God."

Meaning

God loves His people so much! He is full of mercy and compassion. He cares about their sadnesses and troubles, and He comforts them. Many times, God uses His people to comfort each other. They listen to each other. They encourage each other and pray. They remind each other of God's promises. They help each other turn away from disobeying God. No wonder God's people praise Him for giving them each other! He uses them to show His love to each other and to keep on believing in Him their whole lives. We can become God's people when we turn away from our sins and trust in Jesus as our Savior.

Bible Truth 6 ACTS Prayer

- A** God, we praise You for being the Comforter and Strength of Your People. You help them comfort and strengthen each other.
- C** We confess that many times we forget to pray for others who are struggling with hard or sad times. Many times, we don't take time to comfort and strengthen others who are struggling. We need a Savior!
- T** Thank You, God, for the comfort God's people receive from You through how they help and pray for each other.
- S** Work in our hearts that we might turn away from our sins and trust in Jesus as our Savior. Help us to comfort others with Your Word and by praying for them. Use us to help others in their times of need. Help others to see Your love and kindness as we comfort and pray for each other. In Jesus' name we pray, Amen.

Bible Truth 6 Story**The Case of the Prayed-for Prisoner***Philippians***Songs Used in Bible Truth 6**

Big Q & A 13 Song

Big Question 13 Song: Why Do God's People Keep Believing in Him?

Big Question 13 Bible Verse Song: Christ Once Suffered for Sins 1 Peter 3:18, ESV

*Extra Big Question 13 Bible Verse Song: For Christ Suffered Once for Sin**Extra Big Question 13 Bible Verse Song: For God So Loved the World John 3:16, ESV*

Big Question 13 Hymn: To God Be the Glory, v.1

Big Question 13 Praise Song: Blessed Be the Name

Bible Truth 6 Bible Verse: Blessed Be the God and Father 2 Corinthians 1:3-4, ESV

*Bible Truth 6 Extra Bible Verse: Praise be to the God and Father 2 Corinthians 1:3-4,10-13, NIV 1984**Bible Truth 6 Extra Bible Verse: Help Us 2 Corinthians 1:13, ESV**Bible Truth 6 Extra Bible Verse: Let Us Hold Fast the Confession Hebrews 10:23-25**Bible Truth 6 Extra Bible Verse: Encourage One Another 1 Thessalonians 5:11-15, ESV**Bible Truth 6 Extra Bible Verse: Build One Another Up 1 Thessalonians 5:11-15, ESV*

listen to or download songs for free at <https://praisefactory.org>: Deep Down Detectives Music page

“The Case of the Prayed-for Prisoner” Philipians



Detective Dan's Listening Assignment #1

1. Who was the prisoner? Why was he in jail?
2. Who prayed for him?



Detective Dan's Listening Assignment #2

2 Corinthians 1:4, ESV

“We comfort those in any affliction, with the comfort we are comforted by God.”

1. Who did God use to comfort Paul?
2. What did they do that was comforting?

(more listening and discussion questions are included in the curriculum at praisefactory.org)

1. “Oh no! Paul is in prison again for telling people about Jesus!” the believers in Philippi exclaimed.

Prisoners weren’t taken care of very well. They depended on friends on the outside to give them what they needed. Paul might be cold or hungry. He could be sick or lonely. He could be discouraged and scared.

Who was there to help Paul, the believers in Philippi wondered.



1. "Oh no! Paul is in prison again for telling people about Jesus!" the believers in Philippi exclaimed. Prisoners weren't taken care of very well. They depended on friends on the outside to give them what they needed. Paul might be cold or hungry. He could be sick or lonely. He could be discouraged and scared. Who was there to help Paul, the believers in Philippi wondered.

2. God uses His people to help each other keep on living for Him and believing in Him. He uses them to comfort them and take care of their needs, too. These Philippians wanted to be part of God helping Paul.

“WE must help Paul!” the believers in Philippi decided.

But what could THEY do for him? How could THEY help him? They were in Philippi, and he was hundreds of miles away in Rome. How could God use THEM, to help PAUL, from so far away?

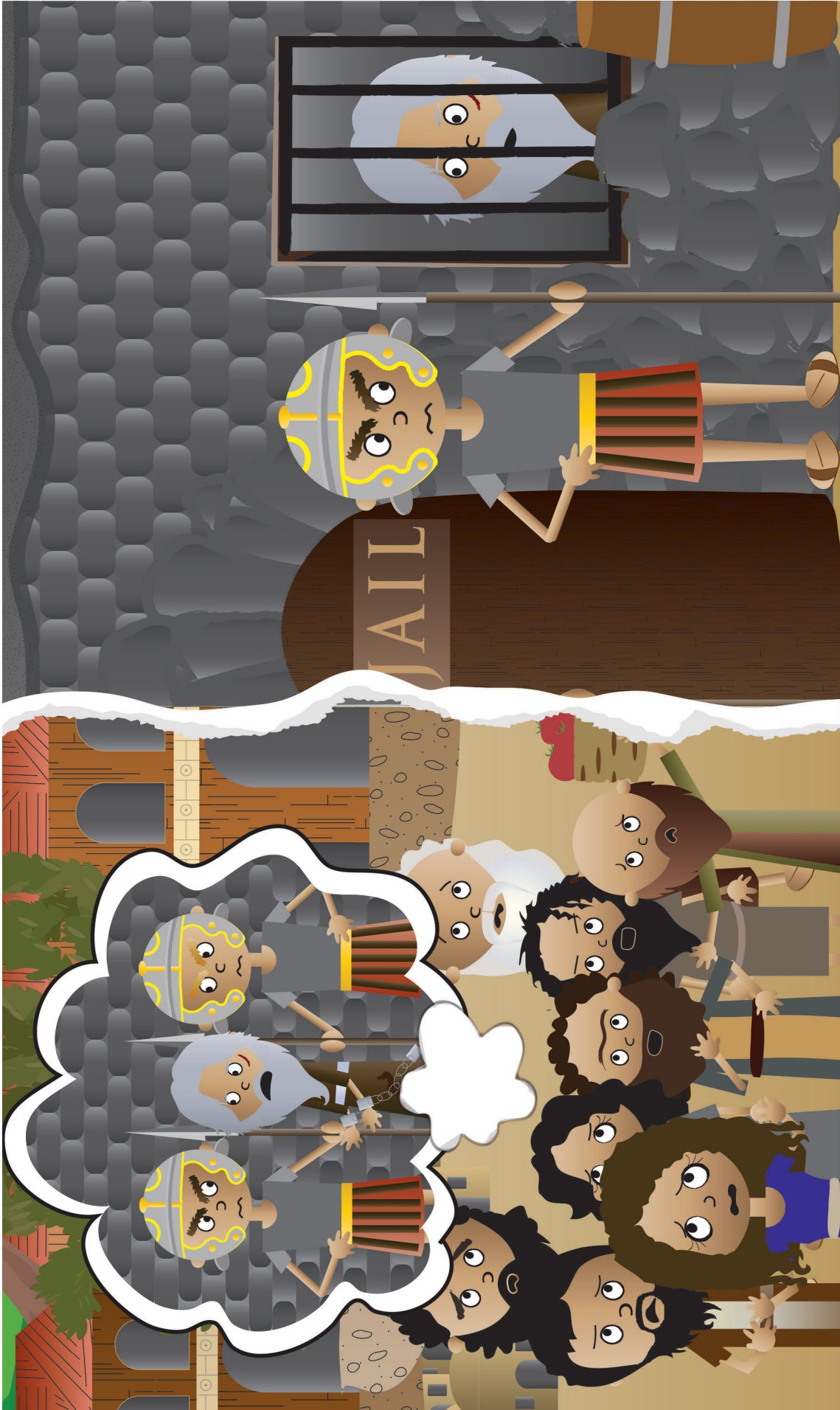

2. God uses His people to help each other keep on living for Him and believing in Him. He uses them to comfort them and take care of their needs, too. These Philippians wanted to be part of God helping Paul. "WE must help Paul!" the believers in Philippi decided. But what could THEY do for him? How could THEY help him? They were in Philippi, and he was hundreds of miles away in Rome. How could God use THEM, to help PAUL, from so far away?

3. The Philippians knew what they could do! They could pray for Paul. Perhaps they were far away from Paul, but God wasn't. He was with Paul all the time and He could do ANYTHING!

They could ask God to work in the heart of Nero, the Roman leader, that he would free Paul. They could ask God to keep Paul from getting sick. They could ask the Holy Spirit to comfort Paul with God's Word and help him stay strong in his faith. Yes, there was so much the Philippians could do for Paul simply by praying for him, right there in Philippi.

But there was something ELSE the Philippians could do for Paul. They could send a gift of money to him.



3. The Philippian knew what they could do! They could pray for Paul. Perhaps they were far away from Paul, but God wasn't. He was with Paul all the time and He could do ANYTHING! They could ask God to work in the heart of Nero, the Roman leader, that he would free Paul. They could ask God to keep Paul from getting sick. They could ask the Holy Spirit to comfort Paul with God's Word and help him stay strong in his faith. Yes, there was so much the Philippians could do for Paul simply by praying for him, right there in Philippi. But there was something ELSE the Philippians could do for Paul. They could send a gift of money to him.

4. The believers in Philippi weren't rich, but they loved Paul. He was the one who came to their city and shared the gospel with them.

Down by the river, Paul had told them the good news of Jesus for the first time. Many, like Lydia, heard and believed.



4. The believers in Philippi weren't rich, but they loved Paul. He was the one who came to their city and shared the gospel with them. Down by the river, Paul had told them the good news of Jesus for the first time. Many, like Lydia, heard and believed.

5. But Paul's good news made others very angry. They had soldiers arrest Paul and his friend, Silas. They hurt them and threw them into jail in chains.

Paul suffered like this, so the Philipians might hear about Jesus. He risked his life that God might save theirs!

Now it was their turn to do something for Paul, even if it was very hard.

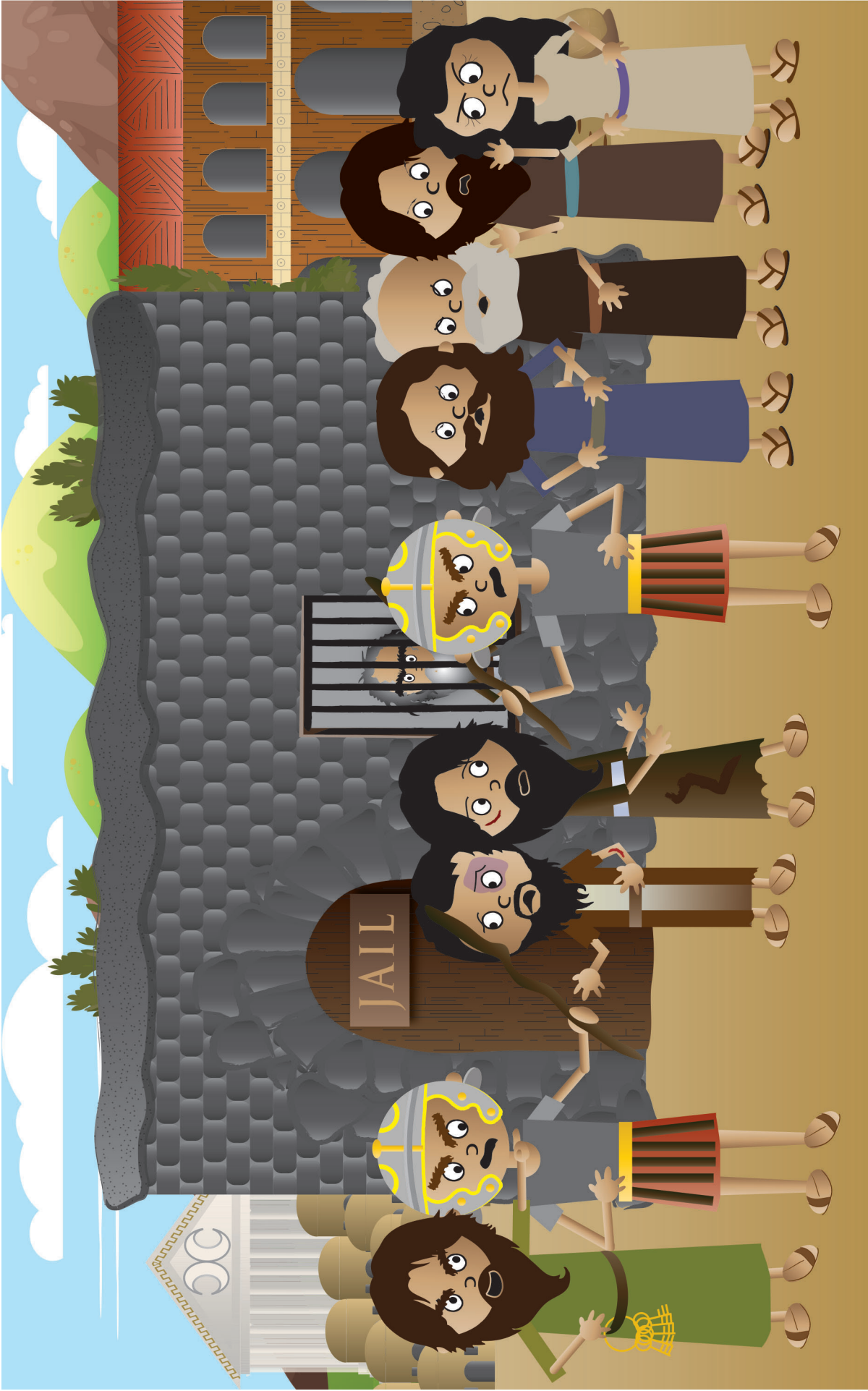

5. But Paul's good news made others very angry. They had soldiers arrest Paul and his friend, Silas. They hurt them and threw them into jail in chains. Paul suffered like this, so the Philipians might hear about Jesus. He risked his life that God might save theirs! Now it was their turn to do something for Paul, even if it was very hard.

6. So, the believers worked together to save money to send to Paul.

Many chose to do without things they needed. “No, thank you, just one loaf of bread. No, thank you, only three fish, today,” was heard around the marketplace, as some may have chosen to have a little less food on their tables, so they could give more to Paul.

“Sheep for sale, goats for sale,” others yelled out at the marketplace. These chose to sell some of their own things to get money to give Paul.

At last, enough money was collected.



6. So, the believers worked together to save money to send to Paul. Many chose to do without things they needed. "No, thank you, just one loaf of bread. No, thank you, only three fish, today," was heard around the marketplace, as some may have chosen to have a little less food on their tables, so they could give more to Paul. "Sheep for sale, goats for sale," others yelled out at the marketplace. These chose to sell some of their own things to get money to give Paul. At last, enough money was collected.

7. Now, there was another problem. Who would take the money all the way to Paul in Rome?

“I’ll take it,” a godly man named Epaphroditus offered. “I’ll take the money and stay and help Paul,” he said.

The Philippians prayed for Epaphroditus and sent him on his way with their gift.

Walk! Walk! Walk! Epaphroditus made the long trip from Philippi to Rome. There were no cars, trains, or planes back then. It would have taken weeks for Epaphroditus to get there, but he was happy to do it. Paul had done so much for them. Epaphroditus was eager to see Paul and help him.



7. Now, there was another problem. Who would take the money all the way to Paul in Rome? "I'll take it," a godly man named Epaphroditus offered. "I'll take the money and stay and help Paul," he said. The Philippians prayed for Epaphroditus and sent him on his way with their gift. Walk! Walk! Walk! Epaphroditus made the long trip from Philippi to Rome. There were no cars, trains, or planes back then. It would have taken weeks for Epaphroditus to get there, but he was happy to do it. Paul had done so much for them. Epaphroditus was eager to see Paul and help him.

8. At last, Epaphroditus made it to the big city of Rome.

Past the temples of the fake, Roman gods, through the busy marketplace, and down the winding streets, went Epaphroditus. Finally, he found the house where Paul was being held prisoner.

“Knock, knock, knock,” Epaphroditus knocked on the door of the little, prison house. “Creak,” the door opened. Epaphroditus looked in and what did he see?



8. At last, Epaphroditus made it to the big city of Rome. Past the temples of the fake, Roman gods, through the busy marketplace, and down the winding streets, went Epaphroditus. Finally, he found the house where Paul was being held prisoner. "Knock, knock, knock," Epaphroditus knocked on the door of the little, prison house. "Creak," the door opened. Epaphroditus looked in and what did he see?

9. There was Paul, chained to a soldier. He was an old man, now. His body was sick and hurting.

But even so, Paul was joyful. He was still living for God and telling people about Jesus. He had even shared the gospel with the soldiers who guarded him. Some were becoming Christians! What good news this was!



9. There was Paul, chained to a soldier. He was an old man, now. His body was sick and hurting. But even so, Paul was joyful. He was still living for God and telling people about Jesus. He had even shared the gospel with the soldiers who guarded him. Some were becoming Christians! What good news this was!

10. Epaphroditus stayed and cared for Paul a long time.

He used the Philippian's money gift to buy Paul food and the other things he needed. He shared with Paul about the Philippians and how they still cared for him and were praying for God to help him.

Oh, how wonderful it was to have a friend to comfort and care for him! Paul loved hearing how the believers in Philippi were doing.

The Lord strengthened him as he and Epaphroditus talked about the Lord and prayed together. What comfort God brought Paul through this one man! Paul was so happy!



10. Epaphroditus stayed and cared for Paul a long time. He used the Philippian's money gift to buy Paul food and the other things he needed. He shared with Paul about the Philippians and how they still cared for him and were praying for God to help him. Oh, how wonderful it was to have a friend to comfort and care for him! Paul loved hearing how the believers in Philippi were doing. The Lord strengthened him as he and Epaphroditus talked about the Lord and prayed together. What comfort God brought Paul through this one man! Paul was so happy!

II. At last, it was time for Epaphroditus to go.

Paul gave Epaphroditus something to take back to the believers in Philippi. He wanted to thank and encourage them. What could a poor, old man in jail give them that would do that? A letter! That's what!

So, Paul got out a piece of paper and started writing. When he finished, he rolled it up and gave it to Epaphroditus. Then, off went Epaphroditus, back home.

How sad Paul must have been to see him go. Yet, how happy Paul would be for the Philippians to read his letter!



II. At last, it was time for Epaphroditus to go. Paul gave Epaphroditus something to take back to the believers in Philippi. He wanted to thank and encourage them. What could a poor, old man in jail give them that would do that? A letter! That's what! So, Paul got out a piece of paper and started writing. When he finished, he rolled it up and gave it to Epaphroditus. Then, off went Epaphroditus, back home. How sad Paul must have been to see him go. Yet, how happy Paul would be for the Philippians to read his letter!

12. Walk, walk, walk. Week after week, Epaphroditus traveled. At last, he made it home to Philippi.

The believers gathered together and Epaphroditus read Paul's letter to them.

This is what Paul wrote:

“Dear Philippians,

I thank my God every time I remember you. In all my prayers for you, I pray with joy because of your partnership in the gospel from the first day until now,” Paul said.



12. Walk, walk, walk. Week after week, Epaphroditus traveled. At last, he made it home to Philippi. The believers gathered together and Epaphroditus read Paul's letter to them. This is what Paul wrote: "Dear Philippians, I thank my God every time I remember you. In all my prayers for you, I pray with joy because of your partnership in the gospel from the first day until now," Paul said.

13. "I want you to know that it's been good for the gospel for me to be in prison.

I've been able to tell many people about Jesus, including all the soldiers who stand guard over me. It makes me happy that so many people are hearing about Jesus," Paul told them.

"Even though life in prison is hard, I am full of joy. God is helping me by your prayers and by His Holy Spirit living in me. God will help me to keep on living for Him and telling others about Jesus," Paul wrote.



13. "I want you to know that it's been good for the gospel for me to be in prison. I've been able to tell many people about Jesus, including all the soldiers who stand guard over me. It makes me happy that so many people are hearing about Jesus," Paul told them. "Even though life in prison is hard, I am full of joy. God is helping me by your prayers and by His Holy Spirit living in me. God will help me to keep on living for Him and telling others about Jesus," Paul wrote.

14. “And one day, God will take me home to be with Him in heaven forever. That will be best of all.”

“Until then, I will be praying for you. I will pray that God strengthen you by His Holy Spirit, just as He is strengthening me. I will pray that He would give you joy; and, that you will keep on living for Him and telling others the good news of Jesus.

**“One day, I hope to be freed from prison and come visit you again”
May Jesus give you strength, Paul.”**



14. "And one day, God will take me home to be with Him in heaven forever. That will be best of all. Until then, I will be praying for you. I will pray that God strengthen you by His Holy Spirit, just as He is strengthening me. I will pray that He would give you joy; and, that you will keep on living for Him and telling others the good news of Jesus. One day, I hope to be freed from prison and come visit you again. May Jesus give you strength, Paul."

15. What happened to Paul after Epaphroditus left?

The Lord had promised that Paul would stand before Caesar Nero, the great, Roman king, himself. And so, he did! Nero heard Paul's case, and no doubt, Paul would have even tried to share the good news of Jesus with him, too.



15. What happened to Paul after Epaphroditus left? The Lord had promised that Paul would stand before Caesar Nero, the great, Roman king, himself. And so, he did! Nero heard Paul's case, and no doubt, Paul would have even tried to share the good news of Jesus with him, too.

16. And, while Nero did NOT become a Christian, he did free Paul from prison. The LORD had answered the Philippian's prayers! Paul was free to spread the good news of Jesus once more.

And, though Paul probably never got to see his dear friends in Philippi again, he would never forget them. God had used them to give him strength and comfort when he needed it the most.

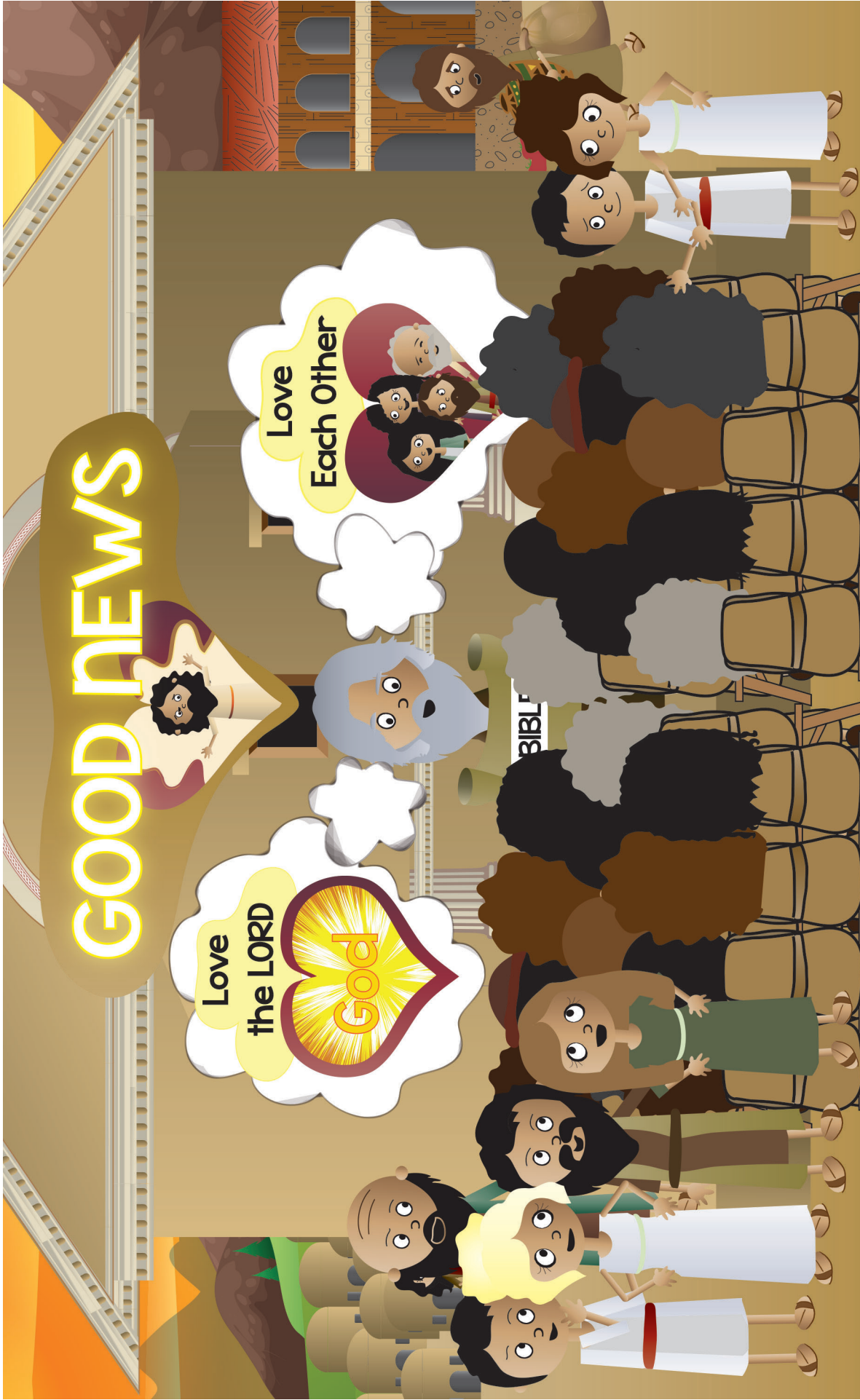

16. And, while Nero did NOT become a Christian, he did free Paul from prison. The LORD had answered the Philippian's prayers! Paul was free to spread the good news of Jesus once more. And, though Paul probably never got to see his dear friends in Philippi again, he would never forget them. God had used them to give him strength and comfort when he needed it the most.

17. But oh, how sweet would be the meeting of these dear friends in heaven, one day!

They had loved each other so well on earth, and now, they would get to go on loving each other forever and ever!

And that's what they are doing, even now!



17. But oh, how sweet would be the meeting of these dear friends in heaven, one day! They had loved each other so well on earth, and now, they would get to go on loving each other forever and ever! And that's what they are doing, even now!

DDD 13.6 Simple Story Scenes

“The Case of the Prayed-for Prisoner” Philippians

SOLVED

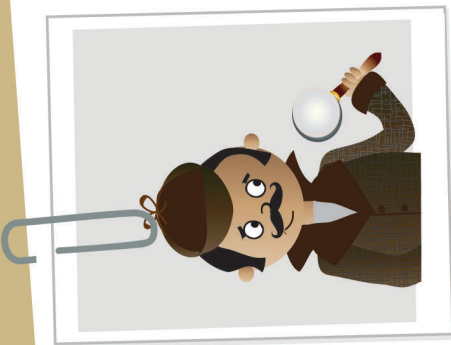

Detective Dan's Listening Assignment #1

1. Who was the prisoner? Why was he in jail? Paul was. He was in jail for telling others about Jesus.
2. Who prayed for him? The believers in the city of Philippi.

For You and Me:
Can you imagine going to jail for something you believe in? Paul did, because he knew the good news of Jesus was true, and that people needed to hear it if they were to be saved from their sins. Paul rejoiced to tell others about Jesus and watch them become God's people. We can become God's people, too, when we turn away from our sins and trust in Jesus as our Savior.

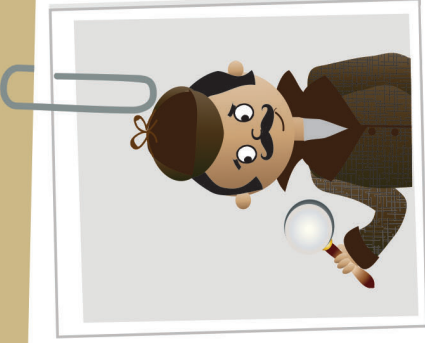

Detective Dan's Listening Assignment #2

2 Corinthians 1:4, ESV

“We comfort those in any affliction, with the comfort we are comforted by God.”

1. Who did God use to comfort Paul? The believers in Philippi.
2. What did they do that was comforting? They prayed for him, sent him money and Epaphroditus to help him.

For You and Me:

Paul was comforted by the help and prayers of the believers in Philippi. He was comforted by their love and by knowing that God was loving him, too, through them. We, too, can know the comfort of God and of God's people, when we turn away from our sins and trust in Jesus as our Savior. That's how we become God's people.

DDD 13.6 Simple Story Scenes

Why Do God's People Keep Believing in Him?
It Is God's Sustaining Grace...
God Uses His People to Strengthen and Comfort
Each Other!

The Gospel



God's people strengthen and comfort each other with the good news of the gospel. That, while we have all chosen to disobey God and deserve His punishment, He sent His Son, Jesus, to be our Savior. Jesus lived a perfect life. Then, on the cross, He gave it as the full payment for the sins of God's people. On Day Three, Jesus rose from the dead. He had really beaten sin and death for them.

God's people also remind each other that this God who saved them through the gospel will keep on giving them everything they need to live for Him. Oh, how comforting that is!

Now, all who turn away from their sins and trust in Jesus as their Savior can be God's people. This is how we can become God's people, too. Ask God to help you!



DDD 13.6 Simple Story Scenes

A Prayer

A God, we praise You for being the Comforter and Strength of Your People. You help them comfort and strengthen each other.

C We confess that many times we forget to pray for others who are struggling with hard or sad times. Many times, we don't take time to comfort and strengthen others who are struggling. We need a Savior!

T Thank You, God, for the comfort God's people receive from You through how they help and pray for each other.

S Work in our hearts that we might turn away from our sins and trust in Jesus as our Savior. Help us to comfort others with Your Word and by praying for them. Use us to help others in their times of need. Help others to see Your love and kindness as we comfort and pray for each other.

In Jesus' name we pray. Amen.



DDD 13.6 Simple Story Scenes

DEEP DOWN DETECTIVES



Take-Home Sheets

CAN YOU GUESS BIBLE TRUTH!:

**Why Do God's People
Keep Believing in Him?**

It Is God's Sustaining Grace...

**God -----
Sustains His People!":**

**HINT: This word means God only
sustains His people. It starts with
an "A" and it rhymes with "bone."**



Deep Down Detective Devotion: Unit 13, Bible Truth 1, Lesson 1



Big Question 13: Why Do God's People Keep Believing in Him?

Answer: It Is God's Sustaining Grace... God Alone Sustains His People!

Bible Truth 1 Meaning

God is the Creator of all things, but He is also the Sustainer of all things. That means He's the one who alone keeps everything working according to His perfect purposes. That includes the stars and the planets, the rocks and the plants, the birds, the fish, the animals, and people. Absolutely everything! God created people with something special inside their bodies: a spirit to know and love Him. We depend upon Him to sustain both our bodies and our spirits. He's the one who works in our heart to turn us away from our sins and trust in Jesus as our Savior. This is how we become God's people. He's the one who gives His people new hearts filled with the Holy Spirit so that they love Him and live for Him. He helps them to keep fighting sin inside their hearts and to faithfully endure the sufferings they face. Without God's sustaining power, God's people know they would never be able to know God or keep on following Him. They depend upon Him to sustain their love and obedience to Him all the days of their lives. They are so grateful that they don't have to depend upon themselves but have His unfailing promise to help them do this. We can become God's people when we turn away from our sins and trust in Jesus as our Savior.

How do I know this is true? The Bible tells me so!

"Now to him who is able to keep you from stumbling and to present you blameless before the presence of his glory with great joy, to the only God, our Savior, through Jesus Christ our Lord, be glory, majesty, dominion, and authority, before all time and now and forever. Amen." -- Jude 1:24-25, ESV

Some Questions for You

1. Who is the Creator and Sustainer of everything in our world? *God is.*
2. Who keeps everything working according to His perfect purposes? *God does.*
3. What did God create people with, so they could know and love Him? *A spirit.*
4. Who do we depend on to sustain our bodies—give us what we need to live? *God*
5. Who sustains our spirits, too? Who must we depend on to help us to work in our hearts and help us to turn away from our sins and trust in Jesus as our Savior? *God.*
6. Who does God give to His people to live inside of their hearts and help them to keep on loving God and living for Him? *His Holy Spirit.*
7. Who helps God's people to keep on fighting sin in their hearts and to keep on trusting in Him, even when it is very hard? *God does.*
8. How can we become one of God's people? *By turning away from our sins and trusting in Jesus as our Savior. Ask God to help you. He loves to answer this prayer!*

Let's Pray!

- A** God, we praise You for being the Sustainer of all things. You keep everything going according to Your perfect plans.
- C** We confess that many times we doubt that You really will sustain us through hard times. We act like You won't be faithful to us. We need a Savior!
- T** God, thank You for Your promises to always sustain Your people, so that they will keep loving and obeying You all their lives.
- S** God, please sustain us. Work in our hearts. Help us to turn away from our sins and trust in Jesus as our Savior. Help us to know You. Give us what we need each day to love You and live for You. In Jesus' name we pray, Amen.

Let's Sing about What We're Learning!

Big Q & A 13 Song from *Deep Down Detectives ESV Songs 13, track 12* (adapted version of "On Top of Old Smoky")

Why do God's people keep believing in God?
And why do God's people keep living for Him?
Because God sustains them, yes, God alone,
That's why God's people keep believing in God.

Go to the Deep Down Detectives Parent Resources for Unit 13 to get the Bible story and many more resources and songs for this unit at praisefactory.org

Big Question 13 Action Rhyme Song from *Deep Down Detectives ESV Songs 13, track 13*

Why Do God's People Keep Believing in Him?
Why do God's people keep believing in Him?
What keeps them going? Why do they persevere?
There's just one reason for their lasting faith,
It is grace, God's sustaining grace.

Refrain
That's why God's people say:
"I'm gonna keep on believing in God,
I'm gonna keep on living for Him,
Yes, I'm gonna keep on believing in God,
And It's all thanks to Him, thanks to Him.

God sustains His people in many ways,
His Spirit works inside them
As they read His Word and pray,
He gives them faith
to keep in trusting in Him,
To keep on living for Him
to the very end. *Refrain*

**"Now to him who is able to keep you from stumbling
and to present you blameless before the presence of his glory with great joy,
to the only God, our Savior, through Jesus Christ our Lord,
be glory, majesty, dominion, and authority, before all time and now and forever. Amen."**

-- Jude 1:24-25, ESV

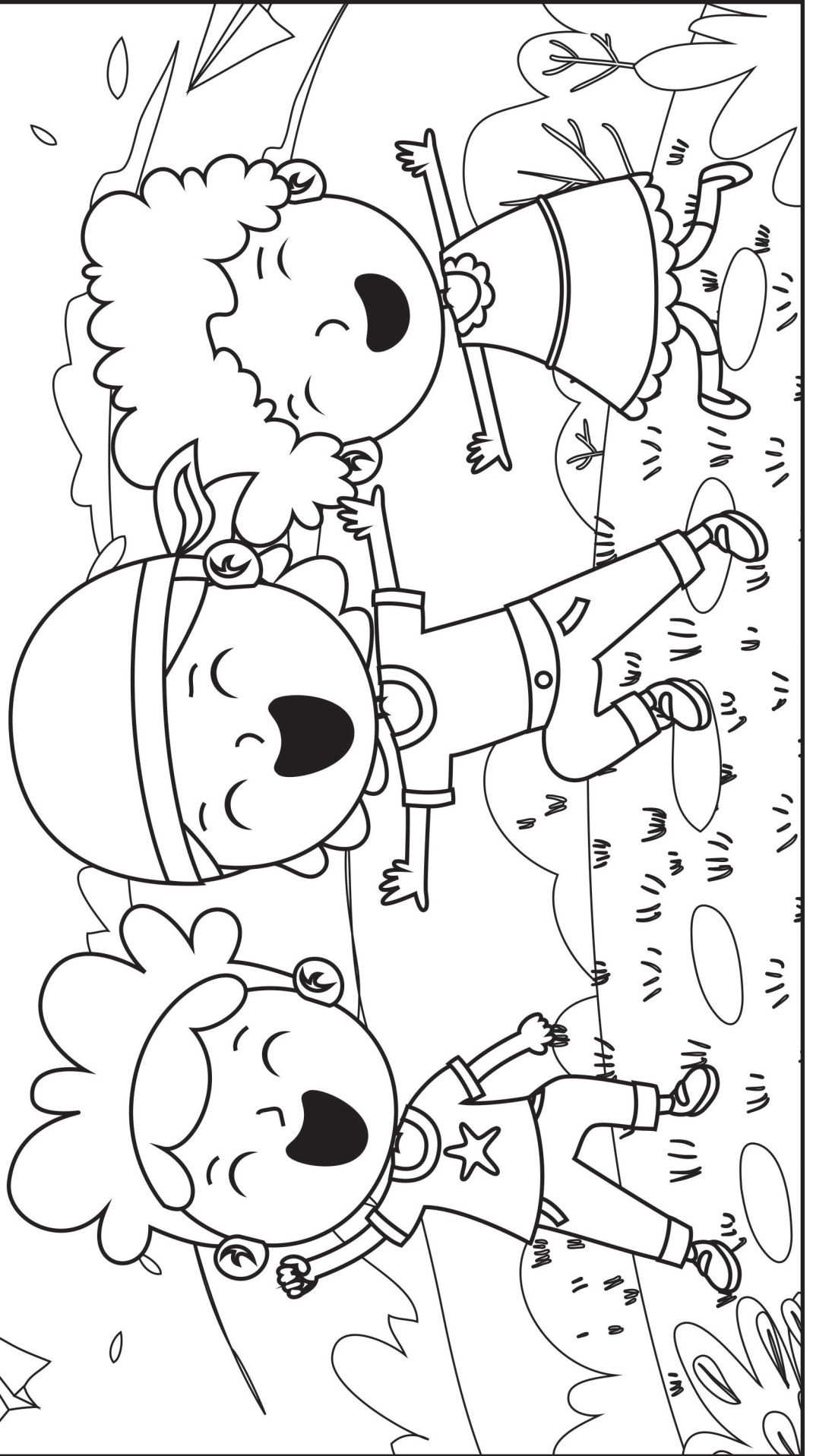

Deep Down Detective Devotion: Unit 13, Bible Truth 1, Lesson 2



Big Question 13: Why Do God's People Keep Believing in Him?

Answer: It Is God's Sustaining Grace... God Alone Sustains His People!

How do I know this is true? The Bible tells me so!

"Now to him who is able to keep you from stumbling and to present you blameless before the presence of his glory with great joy, to the only God, our Savior, through Jesus Christ our Lord, be glory, majesty, dominion, and authority, before all time and now and forever. Amen." -- Jude 1:24-25, ESV

Learn a Little: "Now to [God] who is able to keep you and to present you blameless be glory forever. Amen."

Meaning

We stumble when we trip over a rock or our shoelaces. We have to catch ourselves before we fall down and get hurt. This is how our bodies stumble. But did you know we can stumble inside our heart, too? Our heart stumbles when we are tempted to stop trusting in God or obeying His Word. The sin in our heart makes it easy to stumble.

God's people don't want to stumble in their hearts. They don't want sin to keep them from loving God and living for Him. They know they can't keep themselves from stumbling, but they know that God can. He promises to help them. He promises that all their sins are forgiven through Jesus. He promises to keep on sustaining their love for Him their whole lives. They know that because of God's promise to sustain them, that one day they will come into their His presence and praise His name forever. God was the one who took away their sins. He was the one who helped them every day of their lives! And they will go on praising Him and thanking Him forever. We can become God's people when we turn away from our sins and trust in Jesus as our Savior.

Some Questions for You

1. Who keeps God's people from "stumbling" in loving God and living for Him? *God does.*
2. Who did God send to save His people? *Jesus.*
3. Why will God's people stand before God blameless (that is, not deserving His punishment for their sins)? Who paid for their sins already? *Jesus paid for their sins when He suffered and died on the cross for them.*
4. How can we become God's people? *By turning away from our sins and trusting in Jesus as our Savior.*

Let's Pray!

- A** God, we praise You for being the Sustainer of all things. You keep everything going according to Your perfect plans.
- C** We confess that many times we doubt that You really will sustain us through hard times. We act like You won't be faithful to us. We need a Savior!
- T** God, thank You for Your promises to always sustain Your people, so that they will keep loving and obeying You all their lives.
- S** God, please sustain us. Work in our hearts. Help us to turn away from our sins and trust in Jesus as our Savior. Help us to know You. Give us what we need each day to love You and live for You. In Jesus' name we pray, Amen.

Let's Sing Our Bible Verse!

To Him Who Is Able: Jude 1:24-25 from *Deep Down Detectives ESV Songs 13, track 19*

To him who is able to keep you, (keep you)
To keep you from stumbling, (stumbling)
To present you blameless, (blameless)
Before the presence of his glory with great joy,
(with great joy)

To the only God, our Savior, (Savior)
Through Jesus Christ our Lord, (Lord)
Be glory, majesty, dominion,
And authority, before all time, now and forever.
Amen, Amen, Amen. (Amen)
Amen, Amen, Amen. (Amen)
Amen, Amen, Amen. (Amen)
Jude One, twenty-four and five.

Go to the *Deep Down Detectives Parent Resources for Unit 13* to get the Bible story and many more resources and songs for this unit at praisefactory.org

Which four of these clues belong in our story? Which two do not? Put an X in the boxes of the four that belong.

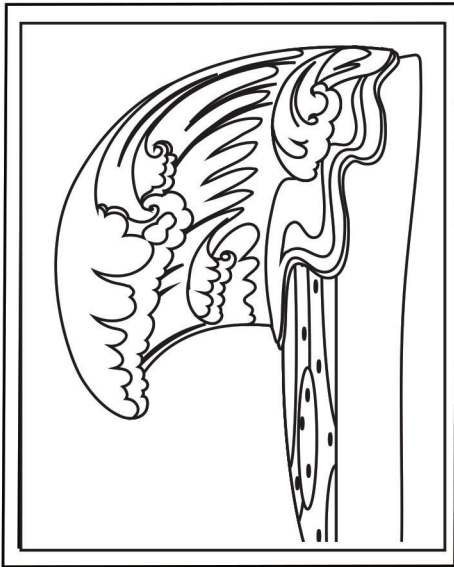

A Wall of Water

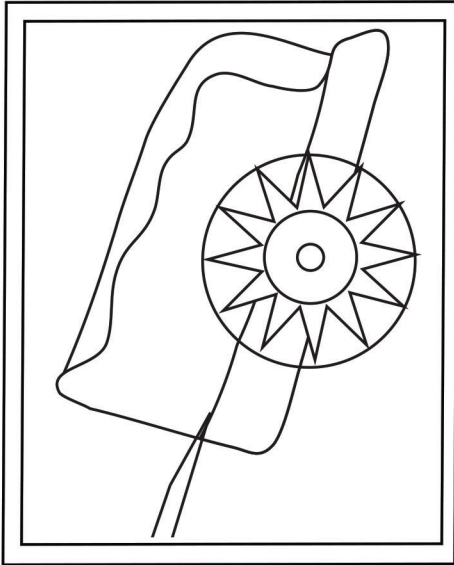

A Chariot

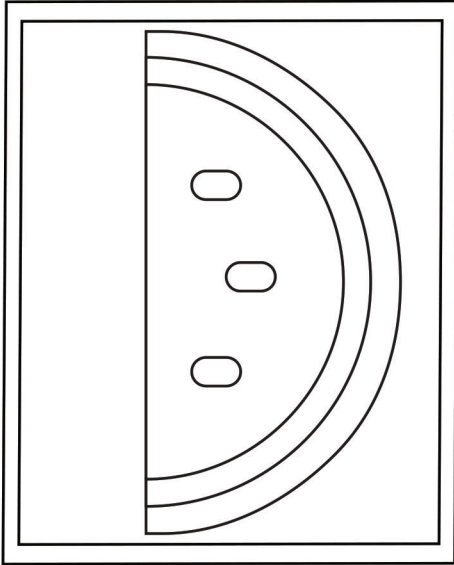

A Watermelon

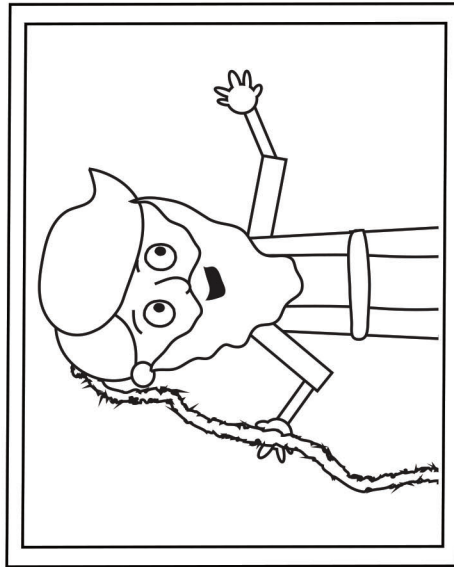

Moses

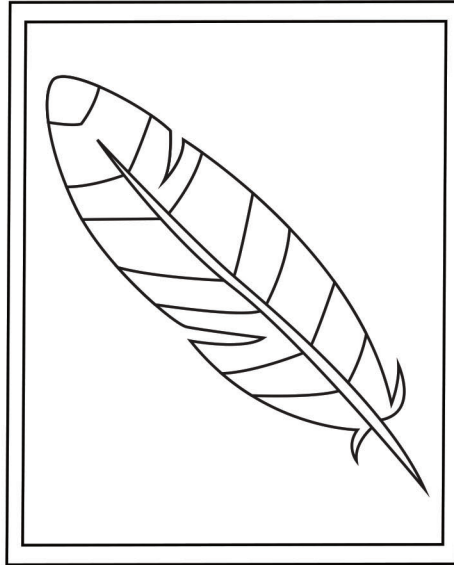

A Feather

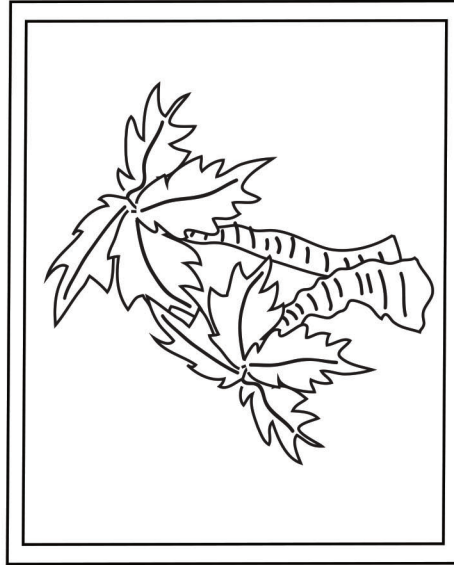

A Dead Plant

Answer: The wall of water, the chariot; Moses; and, the dead plants belong. The watermelon and the feather do not.

Deep Down Detective Devotion: Unit 13, Bible Truth 1, Lesson 3



Big Question 13: Why Do God's People Keep Believing in Him?

Answer: It Is God's Sustaining Grace... God Alone Sustains His People!

Bible Truth 1 Meaning

God is the Creator of all things, but He is also the Sustainer of all things. That means He's the one who alone keeps everything working according to His perfect purposes. That includes the stars and the planets, the rocks and the plants, the birds, the fish, the animals, and people. Absolutely everything! God created people with something special inside their bodies: a spirit to know and love Him. We depend upon Him to sustain both our bodies and our spirits. He's the one who works in our heart to turn us away from our sins and trust in Jesus as our Savior. This is how we become God's people. He's the one who gives His people new hearts filled with the Holy Spirit so that they love Him and live for Him. He helps them to keep fighting sin inside their hearts and to faithfully endure the sufferings they face. Without God's sustaining power, God's people know they would never be able to know God or keep on following Him. They depend upon Him to sustain their love and obedience to Him all the days of their lives. They are so grateful that they don't have to depend upon themselves but have His unfailing promise to help them do this. We can become God's people when we turn away from our sins and trust in Jesus as our Savior.

How do I know this is true? The Bible tells me so!

"Now to him who is able to keep you from stumbling and to present you blameless before the presence of his glory with great joy, to the only God, our Savior, through Jesus Christ our Lord, be glory, majesty, dominion, and authority, before all time and now and forever. Amen." -- Jude 1:24-25, ESV

Some Questions for You

1. What bad thing happened to Jacob's family when there was no rain? *Their crops died. The water dried up. They had no food.*
2. How did the LORD help Jacob's family get food? *He sent Jacob's son, Joseph, ahead of them to Egypt. Joseph was a very important worker for Pharaoh. He could give Jacob everything he needed.*
3. What happened to Jacob's family while they lived in Egypt? *It grew and grew into a whole people--the people of Israel.*
4. What did the new Pharaoh make Jacob's family do for him? *He made them his slaves. He forced them to build his big, new buildings.*
5. Who did the people of Israel need to rescue them from Pharaoh and their hard life in Egypt? *The LORD.*
6. Who did the LORD send to rescue the people of Israel? *Moses.*
7. What did the LORD do to free the people of Israel from Egypt? *He sent frogs, flies, and many other sadnesses upon Pharaoh and his people until at last Pharaoh let them go.*
8. Who did Pharaoh send after Moses and the people of Israel after they left Egypt? *His soldiers on chariots to bring the people back to be his slaves again.*
9. How did the LORD keep the people of Israel from being caught by Pharaoh's soldiers? *He parted the Red Sea so they could go through on dry land. He let the soldiers be swept away in the waters after they had passed through.*
9. What did the people of Israel sing to the LORD when He rescued them? *They praised Him for rescuing them. They praised Him for His unfailing love.*
10. The LORD promised to sustain the people of Israel long ago and He still promises to sustain His people today. How can we become His people? *By turning away from our sins and trusting in Jesus as our Savior.*

Let's Pray!

- A** God, we praise You for being the Sustainer of all things. You keep everything going according to Your perfect plans.
- C** We confess that many times we doubt that You really will sustain us through hard times. We act like You won't be faithful to us. We need a Savior!
- T** God, thank You for Your promises to always sustain Your people, so that they will keep loving and obeying You all their lives.
- S** God, please sustain us. Work in our hearts. Help us to turn away from our sins and trust in Jesus as our Savior. Help us to know You. Give us what we need each day to love You and live for You. In Jesus' name we pray, Amen.

Let's Praise God Right Now!

Big Q & A 13 Hymn: Jesus Paid It All

from *Deep Down Detectives ESV Songs 13, track 17*

Verse 1

I hear the Savior say,
"Thy strength indeed is small,
Child of weakness, watch and pray,
Find in Me thine all in all!"

Refrain

Jesus paid it all,
All to Him I owe;
Sin had left a crimson stain,
He washed it white as snow.

Words: Elvina M. Hall Music: John T. Grape

Big Question 13 Praise Song: I Will Sing of the Mercies

from *Deep Down Detectives ESV Songs 13, track 18*

I will sing of the mercies of the Lord forever,
I will sing, I will sing,
I will sing of the mercies of the Lord forever,
I will sing of the mercies of the Lord.
With my mouth will I make known
Thy faithfulness, Thy faithfulness,
With my mouth will I make known
Thy faithfulness to all generations.

Go to the *Deep Down Detectives Parent Resources for Unit 13* to get the Bible story and many more resources and songs for this unit at praisefactory.org

CAN YOU GUESS BIBLE TRUTH 2:
Why Do God's People Keep
Believing in Him?
It Is God's Sustaining Grace...

Please God,
HELP!

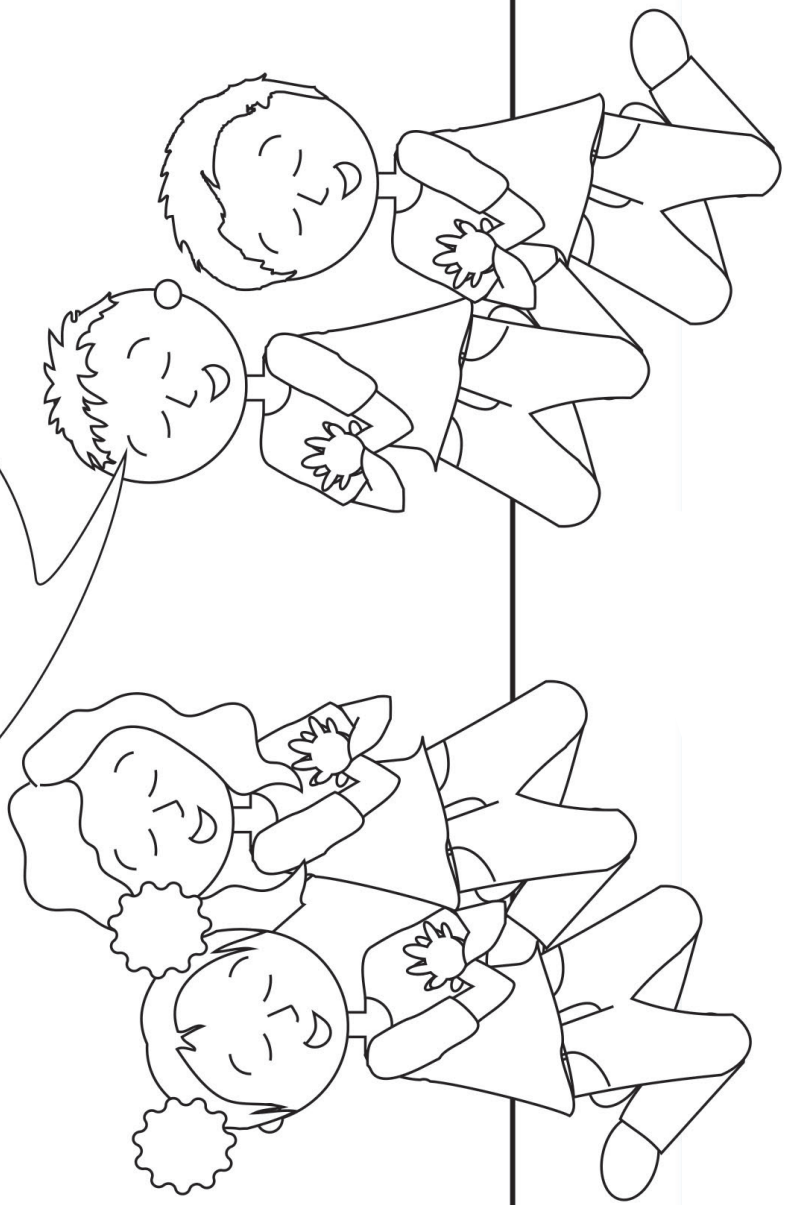

God, the _____, Promises to Help His People!

HINT: Another word for Dad. It starts with an "F" and it rhymes with "bother."

Deep Down Detective Devotion: Unit 13, Bible Truth 2, Lesson 1



Big Question 13: Why Do God's People Keep Believing in Him?

Answer: It Is God's Sustaining Grace... God, the Father, Promises to Help His People!

Bible Truth 2 Meaning

God is a good Father to His people --to all who turn from their sins and trust in Jesus as their Savior. He knows that they can't love Him or live for Him by themselves. He knows they need His help, and He promises to give it to them. He promises to take care of all their needs. He promises to comfort them when they are scared. He promises to help them fight against sin in their lives and rescue them in times of trouble. He promises to make everything in their lives work for their good and His glory. He sent Jesus to take the punishment for their sins on the cross to break the strong hold that sin and death had on them. He promises to send the Holy Spirit to work in their hearts. There is nothing that God's people need that their Heavenly Father will not provide. He will help them do everything He wants them to do, every day of their lives. We can become God's people when we turn away from our sins and trust in Jesus as our Savior.

How do I know this is true? The Bible tells me so!

"Behold, God is my helper; the Lord is the upholder of my life...I will give thanks to your name, O Lord, for it is good. For he has delivered me from every trouble, and my eye has looked in triumph on my enemies." --- Psalm 54:4,6-7, ESV

Some Questions for You

1. What kind of father is God to His people? *God is the best kind of father to His people. He always loves them and does what is best for them. He always cares for them.*
2. Who needs God's help to live for Him? *We all do!*
3. Who does God promise to help love Him and live for Him? *All who ask, but especially His people—all who turn away from their sins and trust in Jesus as their Savior.*
4. What kinds of things does God promise to do for His people? *Provide them with that they need; comfort them; help them fight against sin.*
5. How does God help His people? *He strengthens them by His Word; He saves them through Jesus; and, He lives inside of them by His Holy Spirit.*
6. What will God help His people do? *Everything He wants them to do.*

Let's Pray!

- A** God, we praise You for being faithful to help Your people live for You.
- C** We confess that many times we choose not to trust Your promises to help us. We would rather do things our own way or just depend on ourselves. We need a Savior!
- T** God, thank You for sending Jesus to break the power of sin and death. Thank You for Your promises to always help Your people.
- S** Please work in our hearts. Help us to turn away from our sins and trust in Jesus as our Savior. Help us to ask You for help and depend upon You. Help us to love You and live for You every day of our lives. In Jesus' name we pray, Amen.

Let's Sing about What We're Learning!

Big Q & A 13 Song from *Deep Down Detectives ESV Songs 13, track 12* (adapted version of "On Top of Old Smoky")

Why do God's people keep believing in God?
And why do God's people keep living for Him?
Because God sustains them, yes, God alone,
That's why God's people keep believing in God.

Big Question 13 Action Rhyme Song from *Deep Down Detectives ESV Songs 13, track 13*

Why Do God's People Keep Believing in Him?
Why do God's people keep believing in Him?
What keeps them going? Why do they persevere?
There's just one reason for their lasting faith,
It is grace, God's sustaining grace.

Refrain
That's why God's people say:
"I'm gonna keep on believing in God,
I'm gonna keep on living for Him,
Yes, I'm gonna keep on believing in God,
And It's all thanks to Him, thanks to Him.

God sustains His people in many ways,
His Spirit works inside them
As they read His Word and pray,
He gives them faith
to keep in trusting in Him,
To keep on living for Him
to the very end. *Refrain*

**"Behold, God is my helper; the Lord is the upholder of my life...
I will give thanks to your name, O Lord, for it is good.
For he has delivered me from every trouble,
and my eye has looked in triumph on my enemies." -- Psalm 54:4,6-7, ESV**

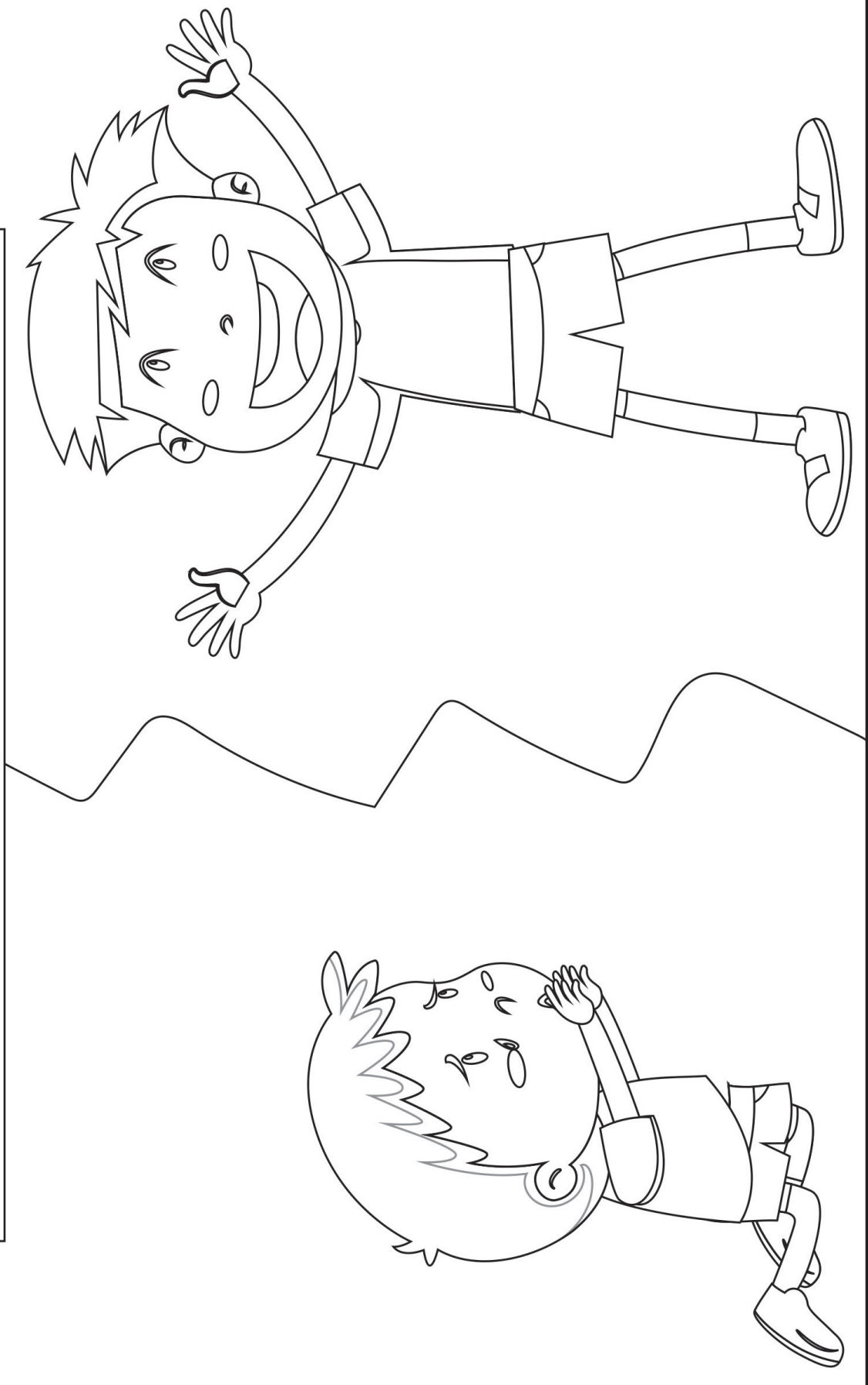

Deep Down Detective Devotion: Unit 13, Bible Truth 2, Lesson 2

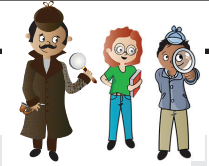

Big Question 13: Why Do God's People Keep Believing in Him?

Answer: It Is God's Sustaining Grace... God, the Father, Promises to Help His People!

How do I know this is true? The Bible tells me so!

"Behold, God is my helper; the Lord is the upholder of my life... I will give thanks to your name, O Lord, for it is good. For he has delivered me from every trouble, and my eye has looked in triumph on my enemies." --- Psalm 54:4,6-7, ESV

Learn a Little: "The Lord is the upholder of my life."

Meaning:

God promises to help His people. He promises to uphold their life, so that they keep on loving Him and living for Him. God has a good plan for each one of His people. He may call them to do some things that are very hard, but He will deliver them out of all their troubles. He promises to give them the strength they need to go through them. He promises to use every trouble for their good. And at just the right time, He will bring their troubles to an end. God's people know they can depend on Him to help them whenever they need help, and to go on helping them for the rest of their lives. He is their sustainer! We can become God's people, too, when we turn away from our sins and trust in Jesus as our Savior.

Some Questions for You

1. How does God sustain His people? *He helps them to keep on loving Him and living for Him. He provides for their needs.*
2. What is God's name? *The LORD.*
3. What is the LORD like? *He is good.*
4. What does God promise to deliver His people from? *Their troubles.*
5. How does God deliver His people from their troubles? *He gives them the strength they need to keep going through times of trouble; He uses them for their good; and, He takes away the troubles at just the right time. Best of all, one day they will go to live with Him and never have any troubles again!*
6. What kinds of enemies does God help His people triumph (win) over? *Anything that keeps them from loving Him and living for Him. Anything enemy that harms them and is against God's good plans for them, especially sin and death.*
7. How does God help His people triumph over these enemies? *He gives them the strength they need to stand against these enemies; He uses even these enemies for good in their lives; and, He takes away the enemies at just the right time. Best of all, one day they will go to live with Him and never have any enemies again!*
8. How can we become God's people and enjoy His promise to save us from our sins and help us keep on loving Him and living Him our whole lives? *By turning away from our sins and trusting in Jesus as our Savior.*

Let's Pray!

- A** God, we praise You for being faithful to help Your people live for You.
- C** We confess that many times we choose not to trust Your promises to help us. We would rather do things our own way or just depend on ourselves. We need a Savior!
- T** God, thank You for sending Jesus to break the power of sin and death. Thank You for Your promises to always help Your people.
- S** Please work in our hearts. Help us to turn away from our sins and trust in Jesus as our Savior. Help us to ask You for help and depend upon You. Help us to love You and live for You every day of our lives. In Jesus' name we pray, Amen.

Let's Sing Our Bible Verse!

Behold God Is My Helper: Psalm 54:4,7

from Deep Down Detectives ESV Songs 13, track 22

Behold, God is my helper; Behold, God is my helper;
The upholder of my life,
Behold, God is my helper; Behold, God is my helper.

Behold, God is my helper; Behold, God is my helper;
He's delivered me from every trouble,
Behold, God is my helper; Behold, God is my helper;

DDD BQ 13 BT2 L2 Coloring Sheet/Take Home pg2

Behold, God is my helper; Behold, God is my helper;
My eyes have looked in triumph on my enemies.
Behold, God is my helper; Behold, God is my helper;
Psalm Fifty-four, four and seven.

Go to the Deep Down Detectives Parent Resources for Unit 13 to get the Bible story and many more resources and songs for this unit at praisefactory.org

Which four of these clues belong in our story? Which two do not? Put an X in the boxes of the four that belong.

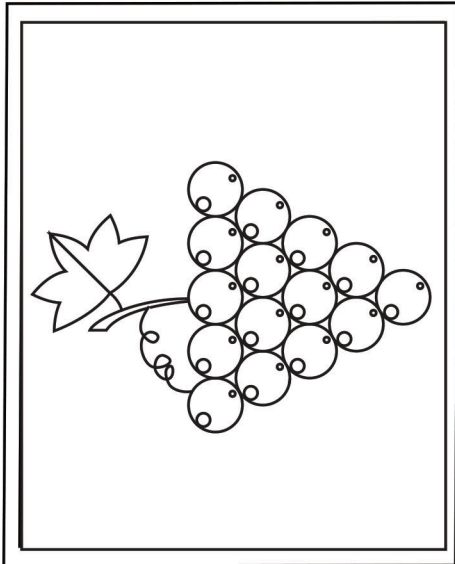

Some Grapes

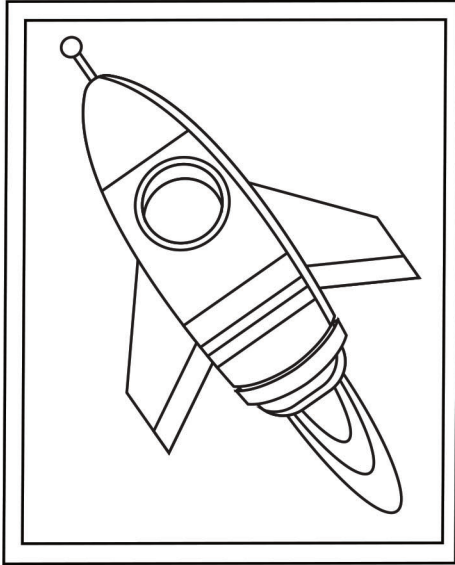

A Rocket

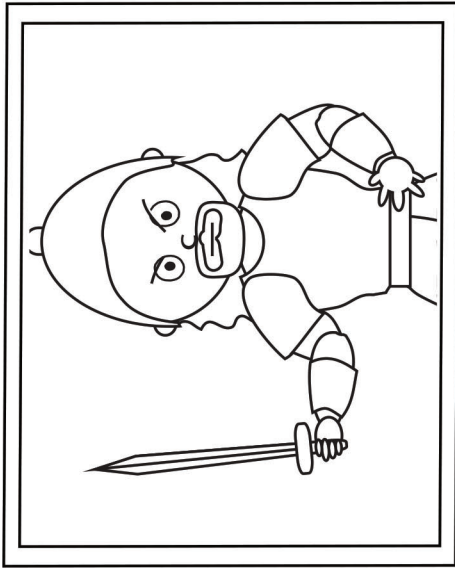

A Giant Enemy

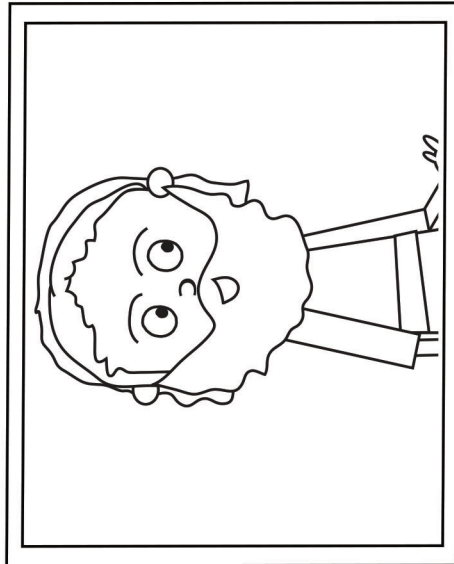

Joshua

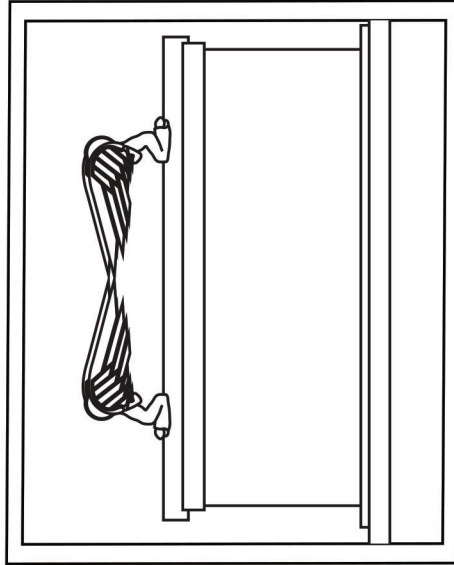

The Ark of the Covenant

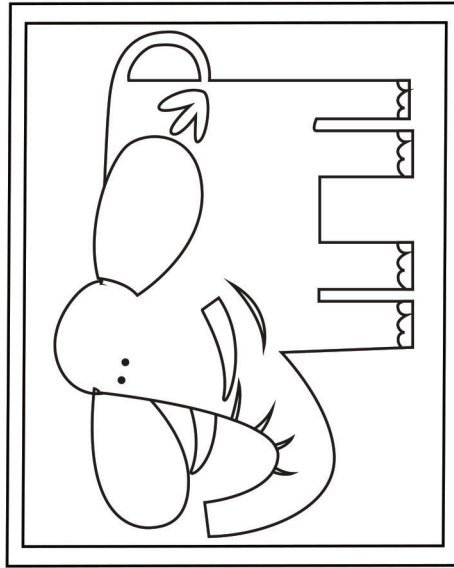

An Elephant

Answers: The grapes; the giant enemy; Joshua, and the Ark of the Covenant belong. The rocket and the elephant do not. DDD 13.2 L3 Coloring Sheet/Take Home

Deep Down Detective Devotion: Unit 13, Bible Truth 2, Lesson 3



Big Question 13: Why Do God's People Keep Believing in Him?

Answer: It Is God's Sustaining Grace... God, the Father, Promises to Help His People!

Bible Truth 2 Meaning

God is a good Father to His people --to all who turn from their sins and trust in Jesus as their Savior. He knows that they can't love Him or live for Him by themselves. He knows they need His help, and He promises to give it to them. He promises to take care of all their needs. He promises to comfort them when they are scared. He promises to help them fight against sin in their lives and rescue them in times of trouble. He promises to make everything in their lives work for their good and His glory. He sent Jesus to take the punishment for their sins on the cross to break the strong hold that sin and death had on them. He promises to send the Holy Spirit to work in their hearts. There is nothing that God's people need that their Heavenly Father will not provide. He will help them do everything He wants them to do, every day of their lives. We can become God's people when we turn away from our sins and trust in Jesus as our Savior.

How do I know this is true? The Bible tells me so!

"Behold, God is my helper; the Lord is the upholder of my life...I will give thanks to your name, O Lord, for it is good. For he has delivered me from every trouble, and my eye has looked in triumph on my enemies." --- Psalm 54:4,6-7, ESV

Some Questions for You

1. How did the LORD rescue the people of Israel from Pharaoh, the king of Egypt? *He sent frogs, gnats and many other sadnesses upon him and his people until he freed them at last.*
2. How did the LORD rescue the people of Israel when they were trapped by the Red Sea and Pharaoh's soldiers were after them? *He parted the Red Sea and let them cross to the other side on dry land.*
3. What good and scary things did the twelve spies find when they went to look over the land of Canaan? *Good: beautiful, big fruit; good land for farming. Scary: fierce, giant enemies who lived in big cities with strong, tall walls and worshipped bad, fake gods.*
4. What did the people think when they heard the ten spies tell about the enemies in the land? *They chose to forget the LORD. They did not trust He could help them beat their enemies. They cried, then they got very angry at the LORD, Moses and Aaron. They wanted to go back to Egypt.*
5. What two spies urged the people to trust in the LORD and take the land He promised them? *Caleb and Joshua.*
6. What punishment did the LORD give the people for not trusting in Him? *Forty years of walking in the desert. The parents would never get to go into the Promised Land, only their children would.*
7. What did the people choose to do when the LORD told them to cross the Jordan River and take the land? *They chose to remember and trust this time.*
8. Did the LORD keep His promise to help His people take the land? *Yes, He did! He was with them and helped them defeat their enemies until the land was all theirs.*
9. What has the LORD done to help us defeat our biggest enemy--sin and death? *He sent Jesus to die on the cross and pay for the sins of all who would ever turn away from their sins and trust in Jesus as their Savior. We can ask God to help us turn away from our sins and trust in Jesus as our Savior. He loves to answer this prayer!*

Let's Pray!

- A** God, we praise You for being faithful to help Your people live for You.
- C** We confess that many times we choose not to trust Your promises to help us. We would rather do things our own way or just depend on ourselves. We need a Savior!
- T** God, thank You for sending Jesus to break the power of sin and death. Thank You for Your promises to always help Your people.
- S** Please work in our hearts. Help us to turn away from our sins and trust in Jesus as our Savior. Help us to ask You for help and depend upon You. Help us to love You and live for You every day of our lives. In Jesus' name we pray, Amen.

Let's Praise God Right Now!

Big Q & A 13 Hymn: Jesus Paid It All

from Deep Down Detectives ESV Songs 13, track 17

Verse 1

I hear the Savior say,
"Thy strength indeed is small,
Child of weakness, watch and pray,
Find in Me thine all in all!"

Refrain

Jesus paid it all,
All to Him I owe;
Sin had left a crimson stain,
He washed it white as snow.

Words: Elvina M. Hall Music: John T. Grape

Go to the Deep Down Detectives Parent Resources for Unit 13 to get the Bible story and many more resources and songs for this unit at praisefactory.org

Big Question 13 Praise Song: I Will Sing of the Mercies

from Deep Down Detectives ESV Songs 13, track 18

I will sing of the mercies of the Lord forever,
I will sing, I will sing,
I will sing of the mercies of the Lord forever,
I will sing of the mercies of the Lord.
With my mouth will I make known
Thy faithfulness, Thy faithfulness,
With my mouth will I make known
Thy faithfulness to all generations.

CAN YOU GUESS BIBLE TRUTH 3:
Why Do God's People Keep
Believing in Him?
It Is God's Sustaining Grace...

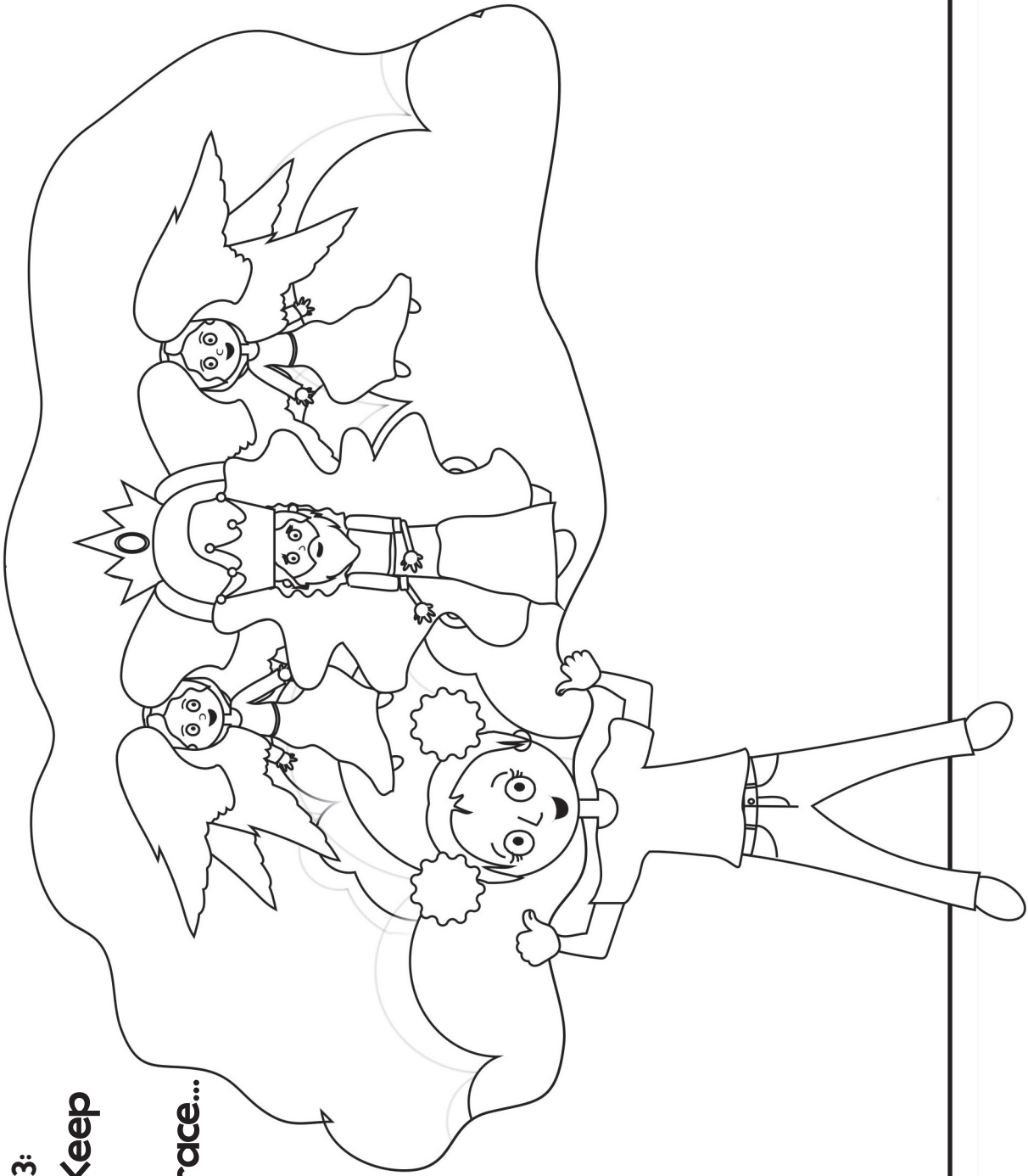

Jesus Provides God's People with Everything They Need to -----
for God!

Deep Down Detective Devotion: Unit 13, Bible Truth 3, Lesson 1



Big Question 13: Why Do God's People Keep Believing in Him?

Answer: It Is God's Sustaining Grace... Jesus Provides God's People with Everything They Need to Live for God!

Bible Truth 3 Meaning

God wants His people to love Him and live for Him. He wants them to love Him with all their heart, mind, and strength. He wants them to love others as themselves. He wants them to be holy, like He is holy. God's people want to love God and live for Him. They know that they bring glory to God when they do, and they want to bring Him glory that more than anything else. But God's people are sinners with sinful hearts. They are often afraid, weak, and tempted to disobey God. How can they ever live the lives God wants them to live? Jesus is how! God not only saved His people through Jesus, but He also promises to give them everything they need to live the lives He wants them to live through Jesus. The Bible tells us that right now in heaven, Jesus is always praying for God's people that they would glorify God and fulfill God's plans for their lives. Jesus' prayers for God's people are always answered with a yes! Jesus will always give them everything they need for life and godliness. It is His promise. What a wonderful Savior Jesus is! We can become God's people and receive all that we need to love and serve God, too, when we turn away from our sins and trust in Jesus as our Savior.

How do I know this is true? The Bible tells me so!

"For we do not have a high priest who is unable to sympathize with our weaknesses, but one who in every respect has been tempted as we are, yet without sin. Let us then with confidence draw near to the throne of grace, that we may receive mercy and find grace to help in time of need." -- Hebrews 4:15-16, ESV

Some Questions for You

1. Who does God want His people to love with all their heart, mind, and strength? *Himself!*
2. Who does God want His people to love as much as they love themselves? *Other people.*
3. Who does God want to be holy, like He is holy? *His people.*
4. Do God's people want to love Him and others, the way God wants them to do? *Yes, they do.*
5. What do God's people have in their hearts that keeps them from loving God and living the way He wants them to live? *Sin.*
6. Who helps God's people live the way God wants them to live? *God does.*
7. Who is praying for God's people in heaven, asking if they would glorify God and fulfill His plans for their lives? *Jesus is.*
8. Who will give God's people everything they need for life and godliness? *Jesus does.*
9. How can we become God's people and receive all that we need to love and live for God? *By turning from our sins and trusting in Jesus as our Savior.*

Let's Pray!

- A** Jesus, we praise You for being the Son of God, the Giver of all the grace God's people need to live God's way.
- C** We confess that many times we don't want to do what You want us to do, or we feel too weak to do it. We forget that if we are God's people (those who turn away from their sins and trust in Jesus), we can depend on Jesus to always give us the grace we need to live God's way. We need You to be our Savior!
- T** Thank You, Jesus, for always giving Your people the grace they need to live God's way. Thank You for promising to be praying for all who trust in You, even now, as You rule in heaven.
- S** Work in our hearts that we would turn from our sins and trust in You, Jesus, as our own Savior. Help us to love one another, and to love God and live for Him, every day of our lives. In Jesus' name we pray, Amen.

Let's Sing about What We're Learning!

Big Q & A 13 Song from *Deep Down Detectives ESV Songs 13, track 12* (adapted version of "On Top of Old Smoky")

Why do God's people keep believing in God?
And why do God's people keep living for Him?
Because God sustains them, yes, God alone,
That's why God's people keep believing in God.

Big Question 13 Action Rhyme Song from *Deep Down Detectives ESV Songs 13, track 13*

Why Do God's People Keep Believing in Him?
Why do God's people keep believing in Him?
What keeps them going? Why do they persevere?
There's just one reason for their lasting faith,
It is grace, God's sustaining grace.

Refrain

That's why God's people say:
"I'm gonna keep on believing in God,
I'm gonna keep on living for Him,
Yes, I'm gonna keep on believing in God,
And It's all thanks to Him, thanks to Him.

God sustains His people in many ways,
His Spirit works inside them
As they read His Word and pray,
He gives them faith
to keep in trusting in Him,
To keep on living for Him
to the very end. *Refrain*

**"For we do not have a high priest who is unable to sympathize with our weaknesses,
but one who in every respect has been tempted as we are, yet without sin.**

**Let us then with confidence draw near to the throne of grace,
that we may receive mercy and find grace to help in time of need."**

-- Hebrews 4:15-16, ESV

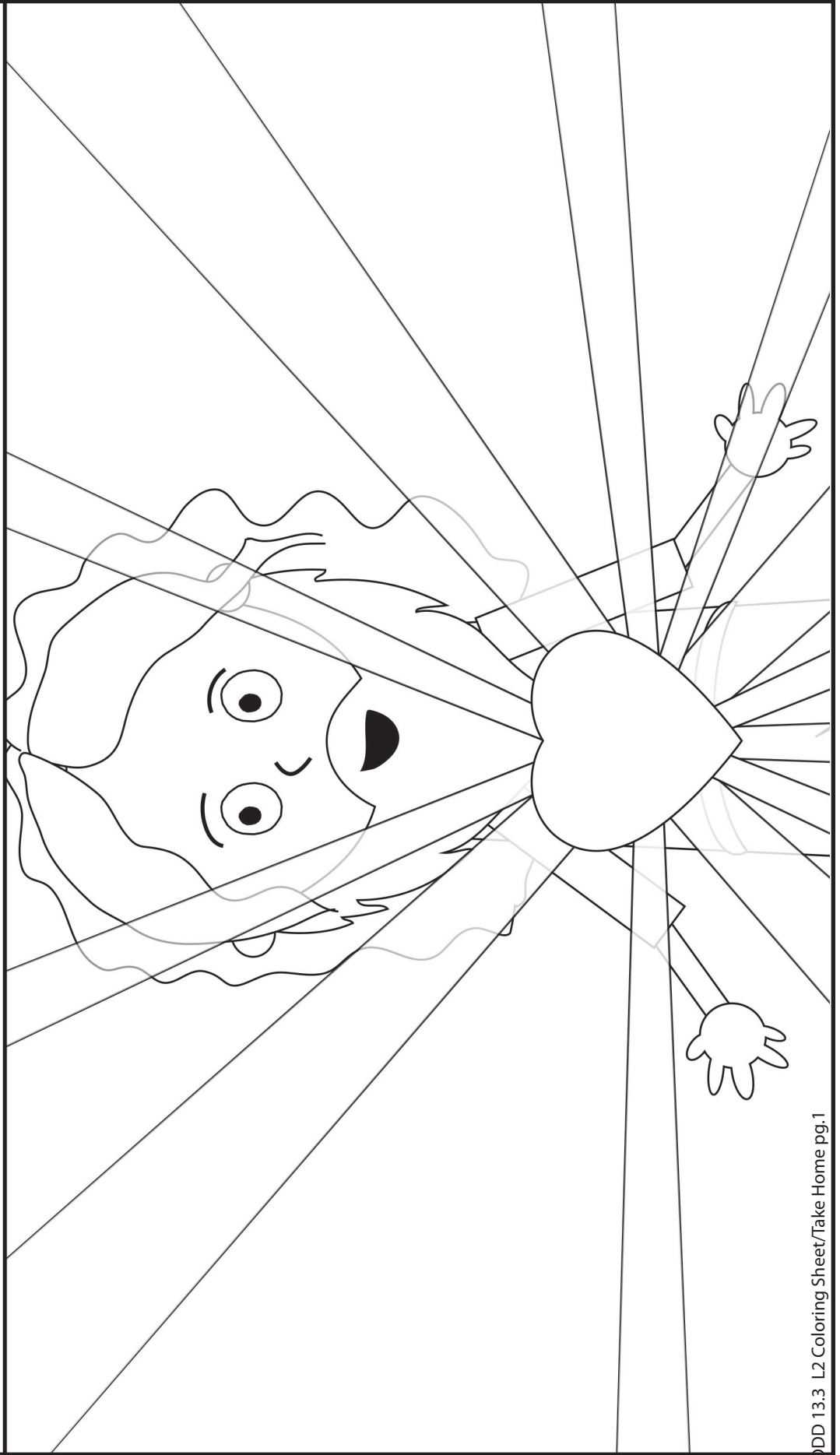

Deep Down Detective Devotion: Unit 13, Bible Truth 3, Lesson 2



Big Question 13: Why Do God's People Keep Believing in Him?

Answer: It Is God's Sustaining Grace... Jesus Provides God's People with Everything They Need to Live for God!

How do I know this is true? The Bible tells me so!

"For we do not have a high priest who is unable to sympathize with our weaknesses, but one who in every respect has been tempted as we are, yet without sin. Let us then with confidence draw near to the throne of grace, that we may receive mercy and find grace to help in time of need." -- Hebrews 4:15-16, ESV

Learn a Little: "Let us with confidence draw near to the throne of grace, that we may find help in time of need."

Meaning

Jesus reigns in heaven as the king over all creation and as the high priest for God's people. What does Jesus do for God's people as their high priest? He listens to their prayers and understands how hard it can be to say "no" to disobeying God. He prays for them, and He promises to give them everything they need to live for God and do all He wants them to do. God's people know they can always pray and ask Jesus to help them. They know He loves to help them in their weakness. He loves to give them the strength they need to love God and live for Him. That's why they go boldly and confidently to Jesus with their prayers. He will always help them! We can be God's people, too, when we turn away from our sins and trust in Jesus as our Savior.

Some Questions for You

1. Who rules in heaven as the high king over all of God's creation? *Jesus does.*
2. Who listens to the prayers of God's people and understands their weakness? *Jesus does.*
3. Who prays for God's people, Himself, as their great high priest? *Jesus does.*
4. Who do God's people know they can always ask for help if their time of need? *Jesus.*
5. What kind of help does Jesus promised to give God's people? *He will give them all of the strength they need to keep on loving God and living for Him. He will take care of their needs.*
6. How can we become God's people? *By turning from our sins and trusting in Jesus as our Savior.*

Let's Pray!

- A** Jesus, we praise You for being the Son of God, the Giver of all the grace God's people need to live God's way.
- C** We confess that many times we don't want to do what You want us to do, or we feel too weak to do it. We forget that if we are God's people (those who turn away from their sins and trust in Jesus), we can depend on Jesus to always give us the grace we need to live God's way. We need You to be our Savior!
- T** Thank You, Jesus, for always giving Your people the grace they need to live God's way. Thank You for promising to be praying for all who trust in You, even now, as You rule in heaven.
- S** Work in our hearts that we would turn from our sins and trust in You, Jesus, as our own Savior. Help us to love one another, and to love God God and live for Him, every day of our lives. In Jesus' name we pray, Amen.

Let's Sing Our Bible Verse!

Let Us with Confidence: Hebrews 4:16 _ from *Deep Down Detectives* ESV Songs 13, track 25

Let us then with confidence draw near,
With confidence draw near the throne of grace,
So that we may receive mercy and find grace,
In our time of need,
Hebrews Four, sixteen.

Which four of these clues belong in our story? Which two do not? Put an X in the boxes of the four that belong.

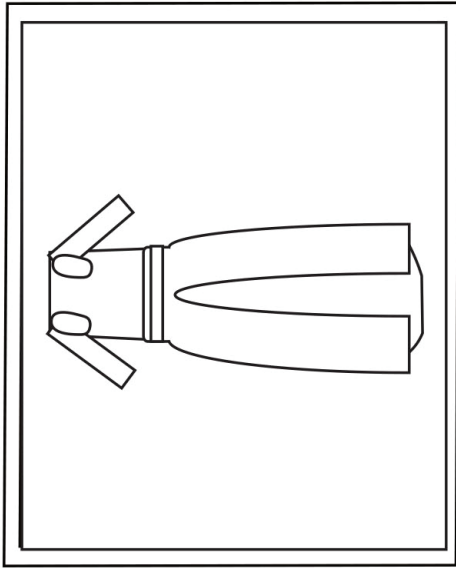

White Clothes

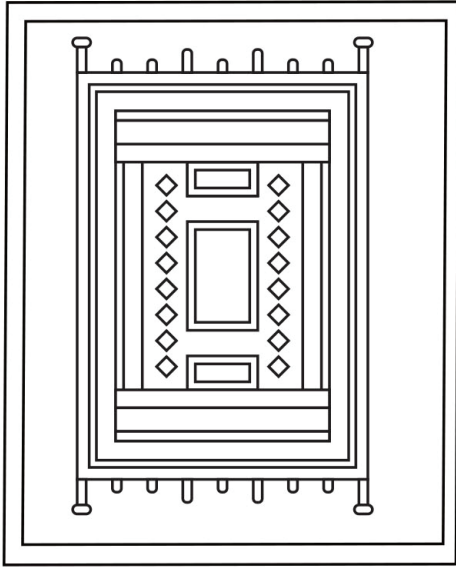

A Rug

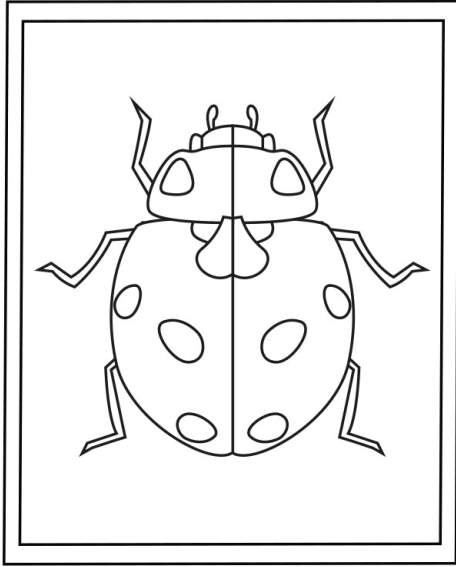

A Ladybug

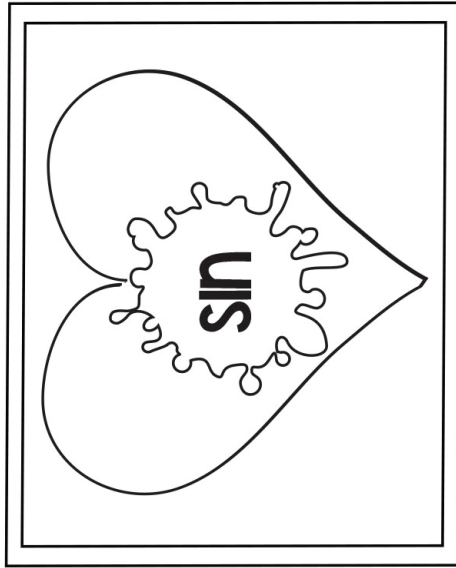

A Sinful Heart

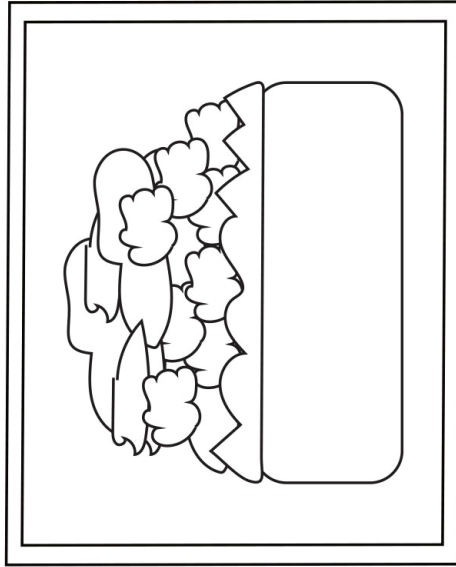

A Worship Gift

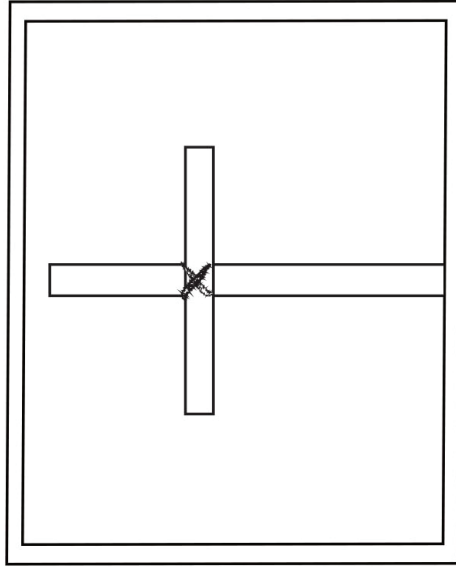

The Cross

Answer: The white clothes, the sinful heart, the worship gift and the cross belong. The rug and ladybug do not.

Deep Down Detective Devotion: Unit 13, Bible Truth 3, Lesson 3



Big Question 13: Why Do God's People Keep Believing in Him?

Answer: It Is God's Sustaining Grace... Jesus Provides God's People with Everything They Need to Live for God!

Bible Truth 3 Meaning

God wants His people to love Him and live for Him. He wants them to love Him with all their heart, mind, and strength. He wants them to love others as themselves. He wants them to be holy, like He is holy. God's people want to love God and live for Him. They know that they bring glory to God when they do, and they want to bring Him glory that more than anything else. But God's people are sinners with sinful hearts. They are often afraid, weak, and tempted to disobey God. How can they ever live the lives God wants them to live? Jesus is how! God not only saved His people through Jesus, but He also promises to give them everything they need to live the lives He wants them to live through Jesus. The Bible tells us that right now in heaven, Jesus is always praying for God's people that they would glorify God and fulfill God's plans for their lives. Jesus' prayers for God's people are always answered with a yes! Jesus will always give them everything they need for life and godliness. It is His promise. What a wonderful Savior Jesus is! We can become God's people and receive all that we need to love and serve God, too, when we turn away from our sins and trust in Jesus as our Savior.

How do I know this is true? The Bible tells me so!

"For we do not have a high priest who is unable to sympathize with our weaknesses, but one who in every respect has been tempted as we are, yet without sin. Let us then with confidence draw near to the throne of grace, that we may receive mercy and find grace to help in time of need." -- Hebrews 4:15-16, ESV

Some Questions for You

1. What was the most important holiday that God's people celebrated long ago? *The Day of Atonement.*
2. What does the big, Bible word "atonement" mean? *Paying for sins so we can be God's people.*
3. Who could be God's people without atonement—without their sins being paid for? Why? *No one. None of us. Because we are all sinners. We all deserve God's punishment, not to be His people.*
4. What was wrong with the high priests and all the special worship gifts they gave to God? *The high priests were sinners, themselves. And the special worship gifts were not the right kind to take away the sins of God's people. They could only keep the people close to God for another year.*
5. Who was the only high priest who was perfect? *Jesus was.*
6. What special worship gift did Jesus give to God that was enough to pay for the sins of God's people? *He took his own, perfect life to pay for their sins, when He suffered and died on the cross.*
7. How do we know that God accepted Jesus' worship gift? How do we know he really paid for the sins of God's people? *Because Jesus rose from the dead on the third day. This showed that He had been beaten sin and death for God's people.*
8. Where is Jesus now? What is He doing? *Jesus went up to heaven to rule. He is there now, still ruling, and still listening to God's people pray, and praying for them, Himself. He is still making sure they have everything they need to love God and live for Him.*
9. How can we become God's people? *By turning away from our sins and trusting in Jesus is our Savior.*

Let's Pray!

- A** Jesus, we praise You for being the Son of God, the Giver of all the grace God's people need to live God's way.
- C** We confess that many times we don't want to do what You want us to do, or we feel too weak to do it. We forget that if we are God's people (those who turn away from their sins and trust in Jesus), we can depend on Jesus to always give us the grace we need to live God's way. We need You to be our Savior!
- T** Thank You, Jesus, for always giving Your people the grace they need to live God's way. Thank You for promising to be praying for all who trust in You, even now, as You rule in heaven.
- S** Work in our hearts that we would turn from our sins and trust in You, Jesus, as our own Savior. Help us to love one another, and to love God God and live for Him, every day of our lives. In Jesus' name we pray, Amen.

Let's Praise God Right Now!

Go to the [Deep Down Detectives Parent Resources for Unit 13](http://www.praisefactory.org) to get the Bible story and many more resources and songs for this unit at [praisefactory.org](http://www.praisefactory.org)

Big Q & A 13 Hymn: Jesus Paid It All

from *Deep Down Detectives ESV Songs 13*, track 17

Verse 1

I hear the Savior say,
"Thy strength indeed is small,
Child of weakness, watch and pray,
Find in Me thine all in all!"

Refrain

Jesus paid it all,
All to Him I owe;
Sin had left a crimson stain,
He washed it white as snow.

Words: Elvina M. Hall Music: John T. Grape

DDD BQ 13 BT 3 L3 Coloring Sheet/Take Home pg2

Big Question 13 Praise Song: I Will Sing of the Mercies

from *Deep Down Detectives ESV Songs 13*, track 18

I will sing of the mercies of the Lord forever,
I will sing, I will sing,
I will sing of the mercies of the Lord forever,
I will sing of the mercies of the Lord.
With my mouth will I make known
Thy faithfulness, Thy faithfulness,
With my mouth will I make known
Thy faithfulness to all generations.

CAN YOU GUESS BIBLE TRUTH 4:
Why Do God's People Keep
Believing in Him?
It Is God's Sustaining Grace...

The Holy Spirit Works

of God's People!

HINT: This word is the opposite of "outside." It starts
with an "l" and it rhymes with "thin slide."

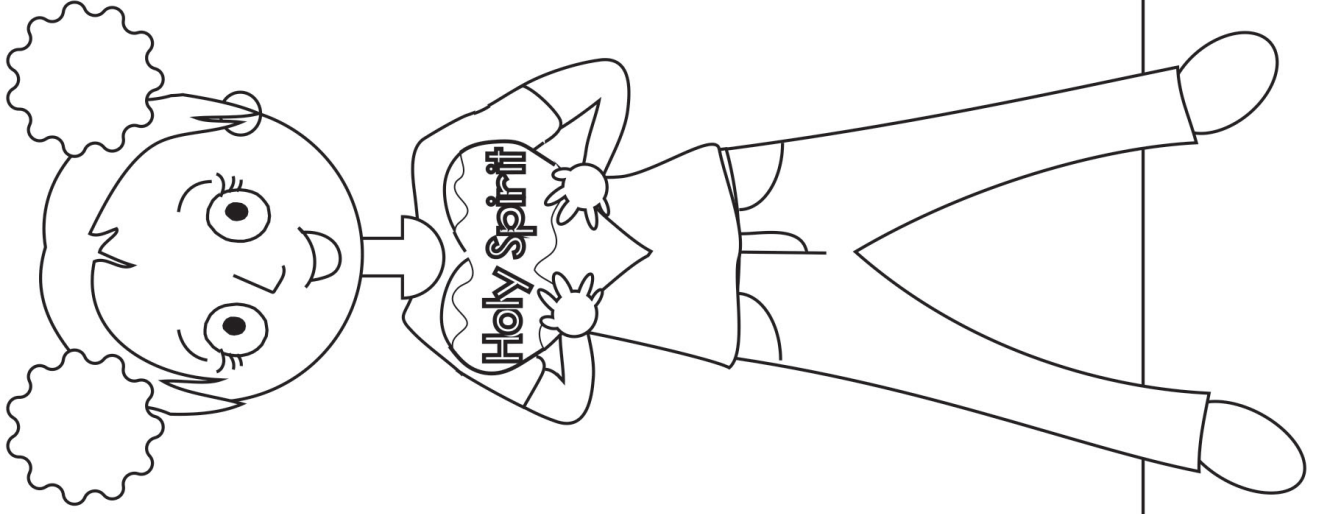

Deep Down Detective Devotion: Unit 13, Bible Truth 4, Lesson 1



Big Question 13 : Why Do God's People Keep Believing in Him?

Answer: It Is God's Sustaining Grace... The Holy Spirit Works Inside of God's People!

Bible Truth 4 Meaning

God created all people with a special heart, deep inside of them. It's different from the heart in your body that pumps blood and you feel beating. This special heart is invisible, but it's the part of you that lives forever and can know God. In the Bible, this special heart is also called our spirit. The sad news is that the beautiful, special heart that God gave us is broken with sin. Yes, we have all chosen to turn away from God and disobey Him. We deserve His punishment, not His friendship. But there's good news, too! God's Holy Spirit can work in our heart and change it. He does this when we listen to God's Word and when we pray. He can help us see our sins, turn away from them, and trust in Jesus as our Savior. This is how we become God's people. And when we do, He makes our heart clean and new, able to know God and want to love and serve Him. And that's just the beginning of what the Holy Spirit does inside us when we become God's people. He goes on working in our hearts, making the most amazing changes. He helps us know God and want to live for Him more and more. He gives us wisdom to understand God's Word and boldness to tell others about Him. He helps us turn away from anger, jealousy, hatred, and pride. He grows love, peace, patience, kindness, joy, goodness, and self-control in their place. What a wonderful gift the Holy Spirit is! God's people would never be able to keep on loving God and living for Him, if the Holy Spirit didn't live inside them. The Holy Spirit can come and live in our hearts, too, when we turn away from our sins and trust in Jesus as our Savior.

How do I know this is true? The Bible tells me so!

"And it is God who establishes us with you in Christ, and has anointed us, and who has also put his seal on us and given us his Spirit in our hearts as a guarantee." --2 Corinthians 1:21-22, ESV

Some Questions for You

1. What is the name of the special heart that God created all people with? *A spirit.*
2. What does this special heart do? *This special heart is the part of us that lives forever and can know God.*
3. What is in the special heart God gave us that caused it to be broken? *Sin.*
4. Who can work in our broken heart and change it? *God's Holy Spirit.*
5. How does the Holy Spirit working in our hearts and change it? *He works in our hearts when we listen to God's word and when we pray. He can help us see our sins, turn away from them, and trust in Jesus as our Savior.*
6. What kind of changes does the Holy Spirit make in our heart when we trust in Jesus as our Savior? *He makes our hearts clean and new, able to know God and wanting to know and serve Him.*
7. How else does the Holy Spirit go on working in the hearts of God's people? *He gives us wisdom to know God's word and boldness to tell others about them. He helps them to turn away from sin and fills them with love, peace, patience, and many other good things.*
8. How can we become God's people who have the Holy Spirit live inside of us? *When we turn away from our sins and trust in Jesus as our Savior.*

Let's Pray!

- A** Holy Spirit, we praise You for the way You can powerfully work in our hearts, changing us from the inside out.
- C** God, we confess that many times we are proud, jealous, envious, and hateful. We need Jesus to save us. We need Your Holy Spirit to replace with humility and love. We need a Savior!
- T** Thank You, Holy Spirit, for being stronger than any of our sins. Thank You for being able to work powerfully in our hearts and truly change us.
- S** Holy Spirit, work in our hearts, help us to turn away from our sins and trust in Jesus as our Savior. Fill our heart with Your good ways. Make us joyful, peaceful, kind, patience, self-controlled, joyful, loving, and good. Give us wisdom and make us bold and strong to do God's will. In Jesus' name we pray, Amen.

Let's Sing Our Bible Verse!

Go to the Deep Down Detectives Parent Resources for Unit 13 to get the Bible story and many more resources and songs for this unit at praisefactory.org

Big Q & A 13 Song from *Deep Down Detectives ESV Songs 13, track 12* (adapted version of "On Top of Old Smoky")

Why do God's people keep believing in God?
And why do God's people keep living for Him?
Because God sustains them, yes, God alone,
That's why God's people keep believing in God.

Big Question 13 Action Rhyme Song from *Deep Down Detectives ESV Songs 13, track 13*

Why Do God's People Keep Believing in Him?
Why do God's people keep believing in Him?
What keeps them going? Why do they persevere?
There's just one reason for their lasting faith,
It is grace, God's sustaining grace.

Refrain
That's why God's people say:
"I'm gonna keep on believing in God,
I'm gonna keep on living for Him,
Yes, I'm gonna keep on believing in God,
And It's all thanks to Him, thanks to Him.

God sustains His people in many ways,
His Spirit works inside them
As they read His Word and pray,
He gives them faith
to keep in trusting in Him,
To keep on living for Him
to the very end. *Refrain*

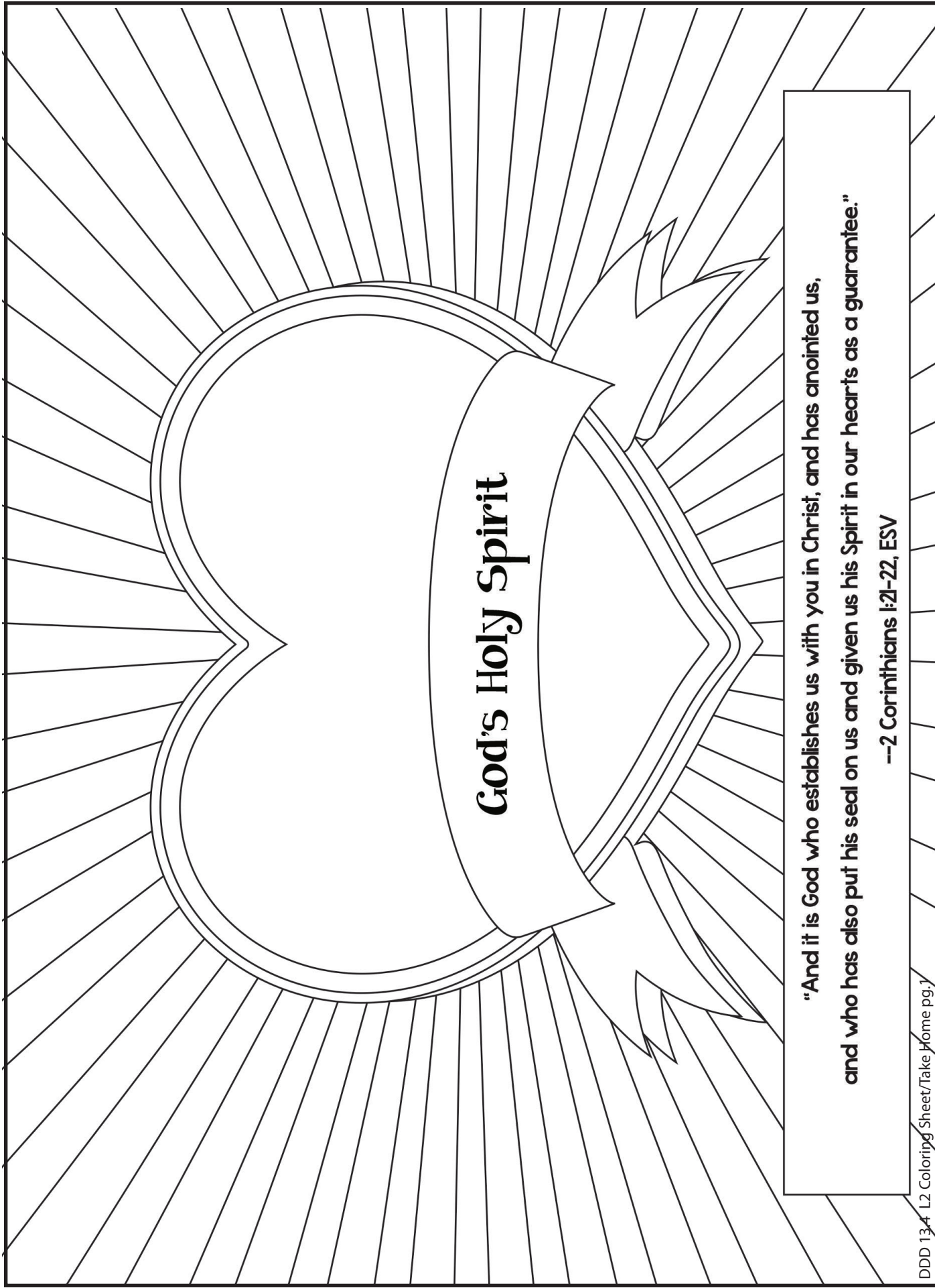

God's Holy Spirit

**"And it is God who establishes us with you in Christ, and has anointed us,
and who has also put his seal on us and given us his Spirit in our hearts as a guarantee."
--2 Corinthians 1:21-22, ESV**

Deep Down Detective Devotion: Unit 13, Bible Truth 4, Lesson 2



Big Question 13 : Why Do God's People Keep Believing in Him?

Answer: It Is God's Sustaining Grace... The Holy Spirit Works Inside of God's People!

How do I know this is true? The Bible tells me so!

"And it is God who establishes us with you in Christ, and has anointed us, and who has also put his seal on us and given us his Spirit in our hearts as a guarantee." --2 Corinthians 1:21-22, ESV

Learn a Little: "God establishes us in Christ, and has given us his Spirit in our hearts."

Meaning

God's people keep on believing in God because God, Himself, establishes them. That means He makes sure they keep on standing firm in their trust in Him. Jesus is the Christ. He's the special one sent by God to save sinners and make them God's people forever. It's because of Jesus that God's people stand firm in their faith. Jesus bought them with His blood. He paid for them and owns them. They will always stand firm in the faith because no one can ever take them away from Him. They will be God's dearly-loved people forever. And as His people, forgiven through Jesus, God gives them another, most wonderful gift: He puts His Holy Spirit in their hearts. The Holy Spirit reminds them that they are God's dearly loved people. He helps them remember the truths of God's Word and believe them. He helps them be strong and brave in Jesus. He reminds them that they belong to God and one day will go to live with Him forever. God's people never have to go through anything alone. God's Holy Spirit is always with them, living inside of them. And He will go on living inside them their whole lives. We can become God's people, too, when we turn away from our sins and trust in Jesus as our Savior.

Some Questions for You

1. What does Christ mean? Who is He? *Christ means special sent one from God. Jesus is the Christ, God's special Sent One who would be the Savior of God's people.*
2. What does establish mean? *To establish something means to make something happen so that it stays that way.*
3. Who did God send to make people like you and me His dearly-loved people and keep us this way forever? *Jesus, the Christ, the special Savior God sent to save us from our sins.*
4. Who do God's people belong to? Who owns them? *God does! How wonderful!*
5. Who does God send to live in the hearts of His people, helping them to keep on believing in Him, loving Him, and living for Him forever? *His Holy Spirit.*
6. How can we become God's people? How can we be His forever and enjoy His Holy Spirit living in our hearts? *By turning away from our sins and trusting in Jesus as our Savior.*

Let's Pray!

- A** Holy Spirit, we praise You for the way You can powerfully work in our hearts, changing us from the inside out.
- C** God, we confess that many times we are proud, jealous, envious, and hateful. We need Jesus to save us. We need Your Holy Spirit to replace with humility and love. We need a Savior!
- T** Thank You, Holy Spirit, for being stronger than any of our sins. Thank You for being able to work powerfully in our hearts and truly change us.
- S** Holy Spirit, work in our hearts, help us to turn away from our sins and trust in Jesus as our Savior. Fill our heart with Your good ways. Make us joyful, peaceful, kind, patience, self-controlled, joyful, loving, and good. Give us wisdom and make us bold and strong to do God's will. In Jesus' name we pray, Amen.

Let's Sing Our Bible Verse!

Go to the Deep Down Detectives Parent Resources for Unit 13 to get the Bible story and many more resources and songs for this unit at praisefactory.org

It Is God Who Establishes Us with You: 2 Corinthians 1:21-22, from Deep Down Detectives ESV Songs 13, track 27

It is God who establishes us with you in Christ,
It is God who establishes us with you in Christ,
Has anointed us, also put his seal on us,
And given us, given us,
His Spirit in our hearts. (Sing it again! Faster!)

It is God who establishes us with you in Christ,
It is God who establishes us with you in Christ,
Has anointed us, also put his seal on us,
And given us, given us,
His Spirit in our hearts.
Second Corinthians One, twenty-one and two.

Which four of these clues belong in our story? Which two do not? Put an X in the boxes of the four that belong.

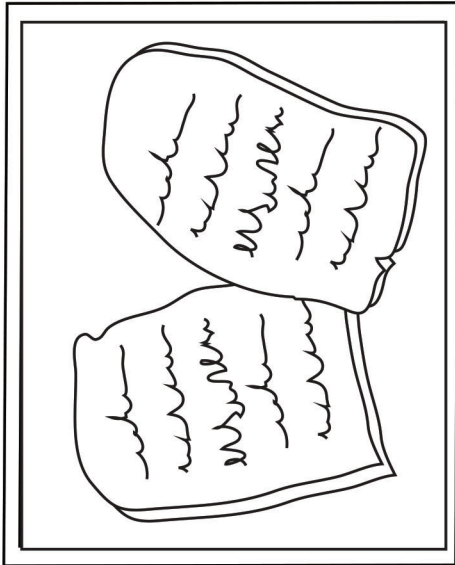

God's Word

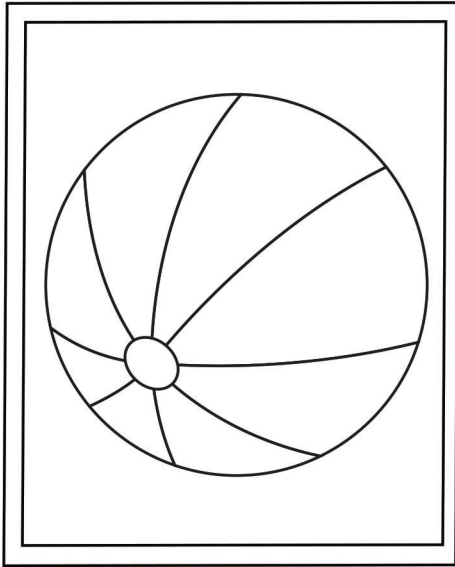

A Beach Ball

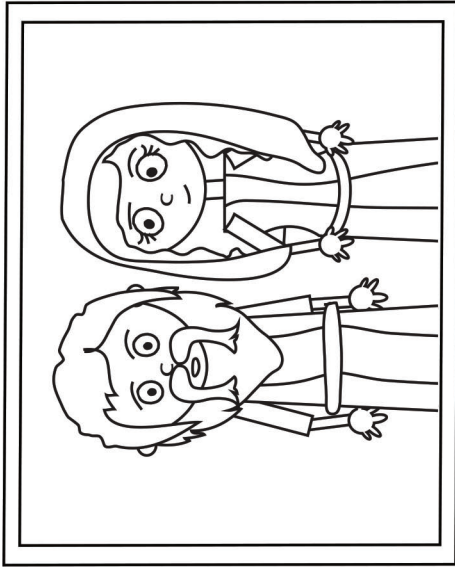

Jews

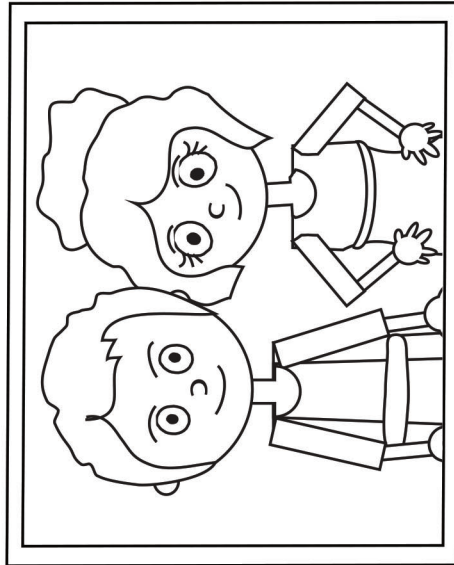

Gentiles

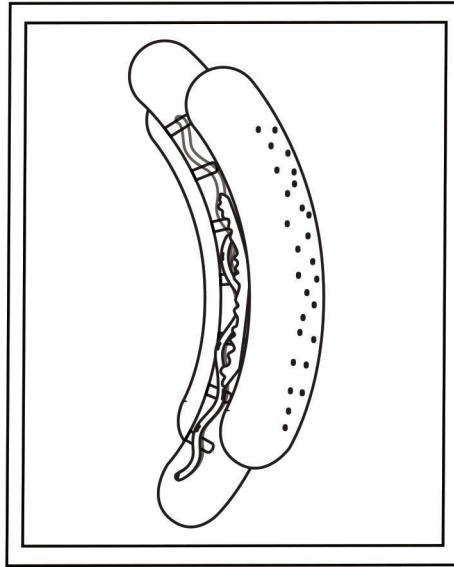

A Hot dog

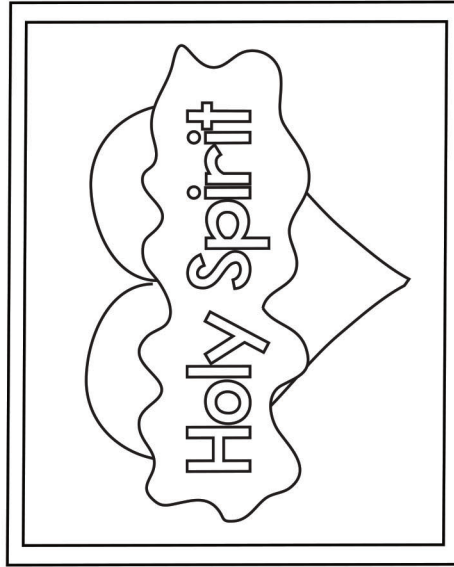

The Holy Spirit in a Heart

Deep Down Detective Devotion: Unit 13, Bible Truth 4, Lesson 3



Big Question 13 : Why Do God's People Keep Believing in Him?

Answer: It Is God's Sustaining Grace... The Holy Spirit Works Inside of God's People!

Bible Truth 4 Meaning

God created all people with a special heart, deep inside of them. It's different from the heart in your body that pumps blood and you feel beating. This special heart is invisible, but it's the part of you that lives forever and can know God. In the Bible, this special heart is also called our spirit. The sad news is that the beautiful, special heart that God gave us is broken with sin. Yes, we have all chosen to turn away from God and disobey Him. We deserve His punishment, not His friendship. But there's good news, too! God's Holy Spirit can work in our heart and change it. He does this when we listen to God's Word and when we pray. He can help us see our sins, turn away from them, and trust in Jesus as our Savior. This is how we become God's people. And when we do, He makes our heart clean and new, able to know God and want to love and serve Him. And that's just the beginning of what the Holy Spirit does inside us when we become God's people. He goes on working in our hearts, making the most amazing changes. He helps us know God and want to live for Him more and more. He gives us wisdom to understand God's Word and boldness to tell others about Him. He helps us turn away from anger, jealousy, hatred, and pride. He grows love, peace, patience, kindness, joy, goodness, and self-control in their place. What a wonderful gift the Holy Spirit is! God's people would never be able to keep on loving God and living for Him, if the Holy Spirit didn't live inside them. The Holy Spirit can come and live in our hearts, too, when we turn away from our sins and trust in Jesus as our Savior.

How do I know this is true? The Bible tells me so!

"And it is God who establishes us with you in Christ, and has anointed us, and who has also put his seal on us and given us his Spirit in our hearts as a guarantee." --2 Corinthians 1:21-22, ESV

Some Questions for You

1. Who were Jews and what did they grow up doing? *People who grew up hearing and obeying God's Word.*
2. What did the Jews tried to do to please God? *They tried to please Him by keeping all of His good laws.*
3. Could the Jews really please God by keeping all of his good laws? *No, they could not! None of them could keep God's laws perfectly, which is the only way we can please God by keeping His laws.*
4. *Who kept all of God's good laws perfectly? Who did the Jews need to put their trust in? Jesus kept God's laws perfectly. The Jews needed to put their trust in Him as their Savior.*
5. What is a Gentile? What did they grow up doing? *Gentiles were people who didn't grow up knowing God's Word or obeying his laws. They worshipped fake gods and did what pleased them.*
6. *Who came to live inside these Jews and Gentiles to help them love God and live for Him? God's Holy Spirit.*
7. What happened when the new believers who had been Gentiles and Jews started gathering together as a church? *They started to go back to their old ways of living. The Gentiles started doing some of the bad things they used to do when they worshipped fake gods. The Jews started to think everyone needed to live like a Jew. Everyone was forgetting the good news of Jesus that saved them.*
8. *What did Paul remind the Galatians to do? What did Paul remind the Galatians when he wrote them? Only by believing in Jesus could they be saved. Only by the Holy Spirit in their hearts could they know and live for God.*
9. *How can we know God and live for Him? By turning away from our sins and trusting in Jesus as our Savior.*

Let's Pray!

- A** Holy Spirit, we praise You for the way You can powerfully work in our hearts, changing us from the inside out.
- C** God, we confess that many times we are proud, jealous, envious, and hateful. We need Jesus to save us. We need Your Holy Spirit to replace with humility and love. We need a Savior!
- T** Thank You, Holy Spirit, for being stronger than any of our sins. Thank You for being able to work powerfully in our hearts and truly change us.
- S** Holy Spirit, work in our hearts, help us to turn away from our sins and trust in Jesus as our Savior. Fill our heart with Your good ways. Make us joyful, peaceful, kind, patience, self-controlled, joyful, loving, and good. Give us wisdom and make us bold and strong to do God's will. In Jesus' name we pray, Amen.

Let's Praise God Right Now!

Big Q & A 13 Hymn: Jesus Paid It All

from Deep Down Detectives ESV Songs 13, track 17

Verse 1

I hear the Savior say,
"Thy strength indeed is small,
Child of weakness, watch and pray,
Find in Me thine all in all."

Refrain

Jesus paid it all,
All to Him I owe;
Sin had left a crimson stain,
He washed it white as snow.

Words: Elvina M. Hall Music: John T. Grape
DDD BQ 13 BT4 L3 Coloring Sheet/Take Home pg2

Go to the Deep Down Detectives Parent Resources for Unit 13 to get the Bible story and many more resources and songs for this unit at praisefactory.org

Big Question 13 Praise Song: I Will Sing of the Mercies

from Deep Down Detectives ESV Songs 13, track 18

I will sing of the mercies of the Lord forever,
I will sing, I will sing,
I will sing of the mercies of the Lord forever,
I will sing of the mercies of the Lord.
With my mouth will I make known
Thy faithfulness, Thy faithfulness,
With my mouth will I make known
Thy faithfulness to all generations.

CAN YOU GUESS BIBLE TRUTH 5:
Why Do God's People Keep
Believing in Him?
It Is God's Sustaining Grace...

The _____ of
God Feeds God's People!'

HINT: The Bible is called "God's _____?"
It starts with a "w" and it rhymes
with "heard."

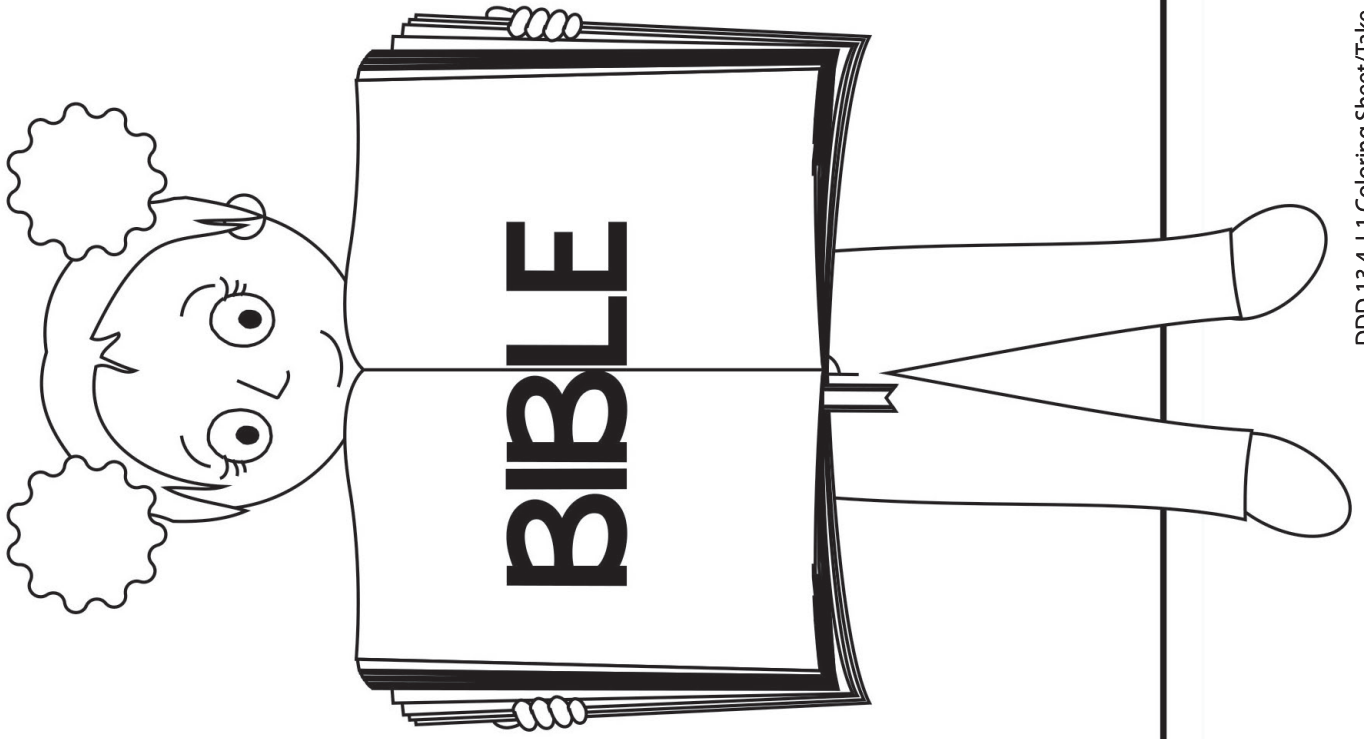

Deep Down Detective Devotion: Unit 13, Bible Truth 5, Lesson 1



Big Question 13 : Why Do God's People Keep Believing in Him?

Answer: It Is God's Sustaining Grace... The Word of God Feeds God's People!

Bible Truth 5 Meaning

When your body is hungry you feed it food. The food makes your body strong to do what you need it to do. But did you know that the spirit God put inside our bodies needs to be fed, too? Not hamburgers or hot dogs, but a spiritual kind of food. What is this spiritual food? It's the Word of God, the Bible. When God's people read God's Word, the Holy Spirit uses it to feed their spirits. He uses it to help them know God better, to guide them in God's will, and to give them strength to do whatever God wants them to do. And just like our bodies work best if we feed them each day, God's people know that it is best for their spirits if they read and think about God's Word every day. They know that God uses His Word to sustain them, even through the most difficult times. We can become God's people, too, when we turn away from our sins and trust in Jesus as our Savior. Then, God will use His Word to help us to keep on loving and living for Him, too.

How do I know this is true? The Bible tells me so!

"For whatever was written in former days was written for our instruction, that through endurance and through the encouragement of the Scriptures we might have hope." --Romans 15:4, ESV

Some Questions for You

1. What does our body need to grow strong? *Food.*
2. What does our spirit need to grow strong? *God's Word, the Bible.*
3. Who helps God's people grow strong as they read the Bible? *The Holy Spirit.*
4. How does the Holy Spirit use God's Word to make His people strong? *He uses it to help them know God better, to guide them in God's will, and to give them strength to do whatever God wants them to do.*
5. Why is it good for God's people to take time to read the Bible each day? *Every day, God's people need His help to live for them. They know God uses His Word to help them do this. He helps them be ready for whatever each day brings.*
6. How can we become God's people? *By turning away from our sins and trusting in Jesus as our Savior.*

Let's Pray!

- A** God, we praise You for being the Giver of Your Word, the Bible.
- C** We confess that many times we don't want to read Your Word or live by it. We need a Savior!
- T** Thank You for promising to use Your Word, the Bible, to strengthen Your people and help them to know You and love You better. Thank You for using it to help them keep on believing in You and living for You.
- S** God, use Your Word to help us to turn away from our sins and trust in Jesus as our Savior. Help us to know You and love You better as we read it. Send Your Holy Spirit to work in our hearts, helping us to understand Your Word and live it out.
In Jesus' name we pray, Amen.

Let's Sing about What We're Learning!

Big Q & A 13 Song from *Deep Down Detectives ESV Songs 13, track 12* (adapted version of "On Top of Old Smoky")

Why do God's people keep believing in God?
And why do God's people keep living for Him?
Because God sustains them, yes, God alone,
That's why God's people keep believing in God.

Big Question 13 Action Rhyme Song from *Deep Down Detectives ESV Songs 13, track 13*

Why Do God's People Keep Believing in Him?
Why do God's people keep believing in Him?
What keeps them going? Why do they persevere?
There's just one reason for their lasting faith,
It is grace, God's sustaining grace.

Refrain
That's why God's people say:
"I'm gonna keep on believing in God,
I'm gonna keep on living for Him,
Yes, I'm gonna keep on believing in God,
And It's all thanks to Him, thanks to Him.

God sustains His people in many ways,
His Spirit works inside them
As they read His Word and pray,
He gives them faith
to keep in trusting in Him,
To keep on living for Him
to the very end. *Refrain*

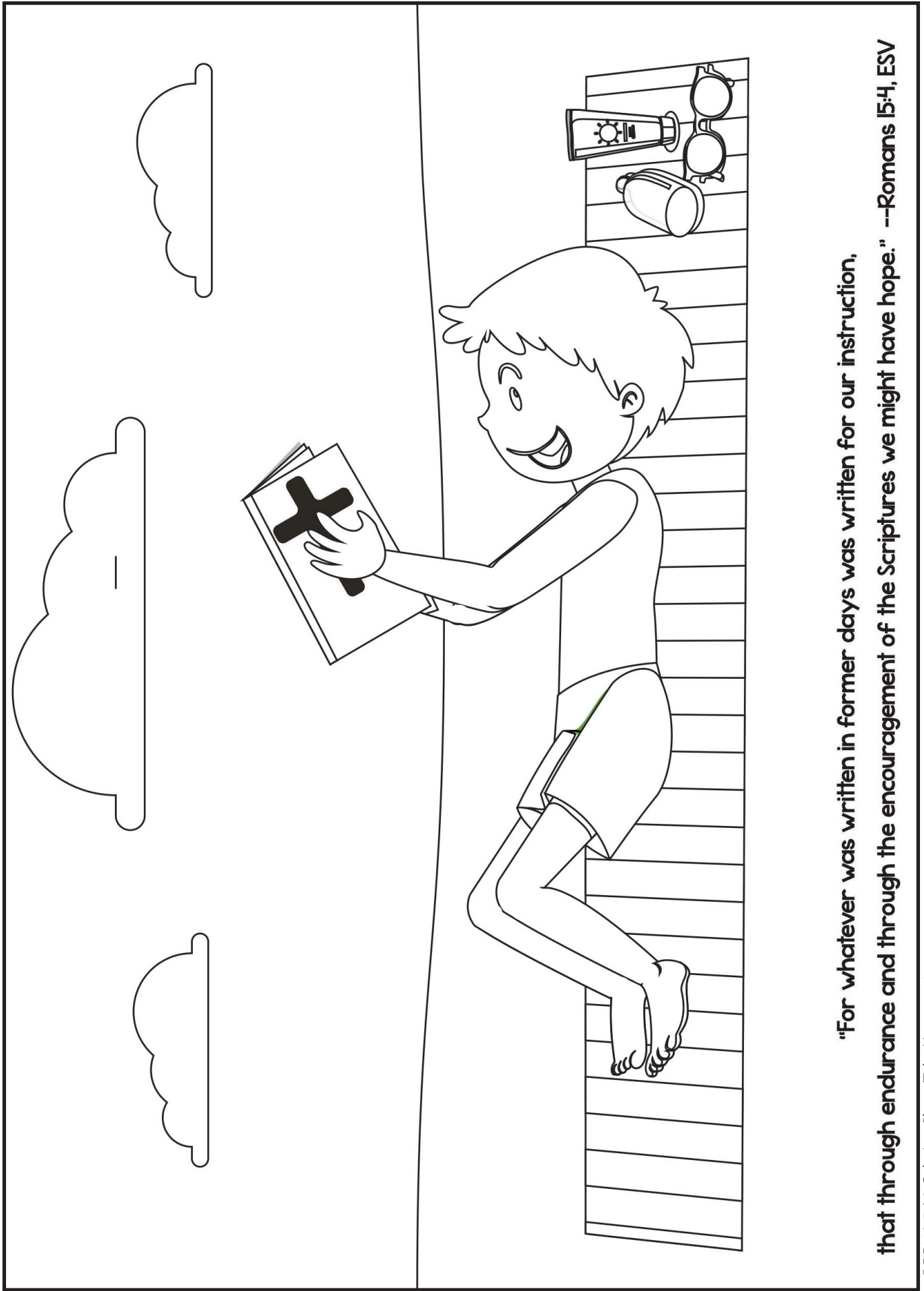

"For whatever was written in former days was written for our instruction, that through endurance and through the encouragement of the Scriptures we might have hope." --Romans 15:4, ESV

Deep Down Detective Devotion: Unit 13, Bible Truth 5, Lesson 2



Big Question 13: Why Do God's People Keep Believing in Him?

Answer: It Is God's Sustaining Grace... God Uses His People to Strengthen and Comfort Each Other!

How do I know this is true? The Bible tells me so!

"For whatever was written in former days was written for our instruction, that through endurance and through the encouragement of the Scriptures we might have hope." --Romans 15:4, ESV

Learn a Little: "Through the encouragement of the Scriptures we have hope."

Meaning

God's Word, the Bible, was written long ago. God made sure everything was written down just right. He wanted His people to be able to trust every promise, and have hope that He would always take care of them and always be working for their good and His glory. He wanted them to read His Word and be instructed--that is, learn--how He wants them to love Him and live for Him.

God's Word may have been written long, long ago, but it still is just as true as ever. God still uses it to give God's people hope. He uses it to help them keep on loving Him and living for Him. He uses it to help them keep looking forward to the day when they will live with Him forever. Read God's Word! He can use it to help you to trust in Him and live for Him, too! He can give you hope!

Some Questions for You

1. What is the name of God's Word that was written down long ago? *The Bible.*
2. Why did God give us His Word? Why did He write it down? *To instruct us; that is, to teach us.*
3. What did God want to teach us through His Word? *How to love Him and live for Him. He wanted us to hope in His good promises.*
4. What is the biggest and best promise God has given us? *The promise that tells us how we can become God's people? He promises to forgive our sins and make us His dearly-loved people when we turn away from our sins and trust in Jesus as our Savior.*

Let's Pray!

- A** God, we praise You for being the Giver of Your Word, the Bible.
- C** We confess that many times we don't want to read Your Word or live by it. We need a Savior!
- T** Thank You for promising to use Your Word, the Bible, to strengthen Your people and help them to know You and love You better. Thank You for using it to help them keep on believing in You and living for You.
- S** God, use Your Word to help us to turn away from our sins and trust in Jesus as our Savior. Help us to know You and love You better as we read it. Send Your Holy Spirit to work in our hearts, helping us to understand Your Word and live it out. In Jesus' name we pray, Amen.

Let's Sing Our Bible Verse!

For Whatever Was Written: Romans 15:4 from *Deep Down Detectives* ESV Songs 13, track 34

For whatever was written in former days
Was written for our instruction,
For whatever was written in former days
Was written for our instruction.
That through endurance and encouragement,
Of the Scriptures, we might have hope.
That through endurance and encouragement,
Of the Scriptures, we might have hope.
Romans Chapter Fifteen, verse four.

Go to the *Deep Down Detectives* Parent Resources for Unit 13 to get the Bible story and many more resources and songs for this unit at praisefactory.org

Which four of these clues belong in our story? Which two do not? Put an X in the boxes of the four that belong.

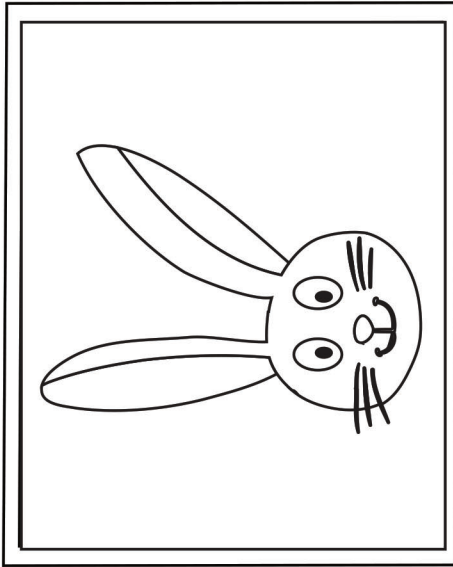

A Rabbit

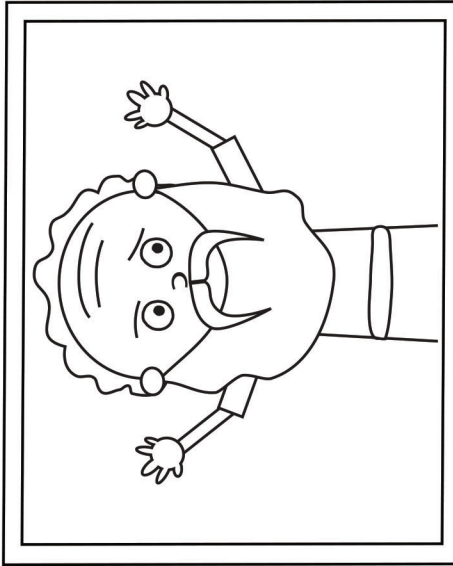

A Bad Teacher

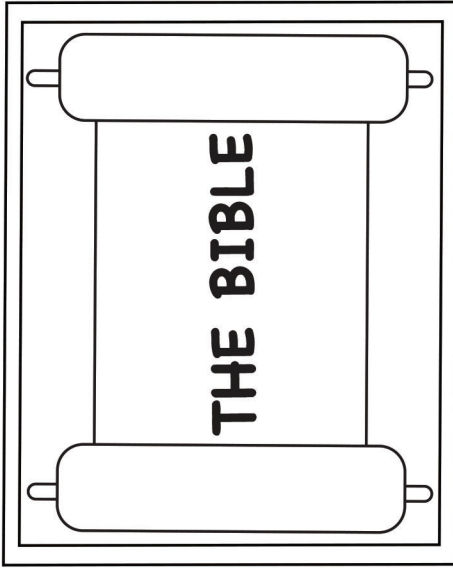

God's Word

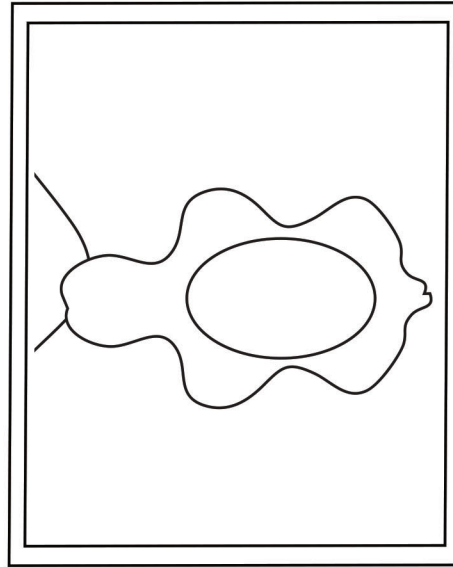

A Magic Stone

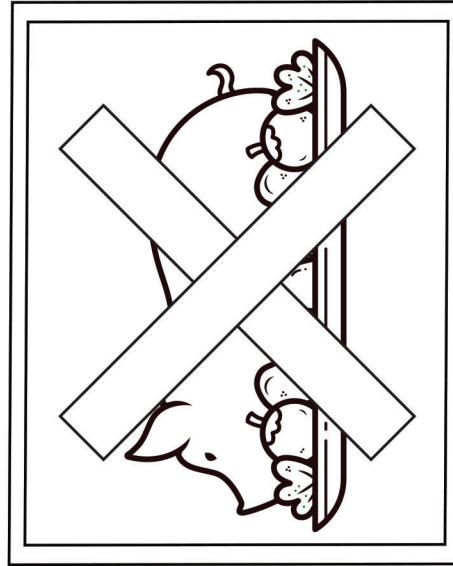

Bad Food

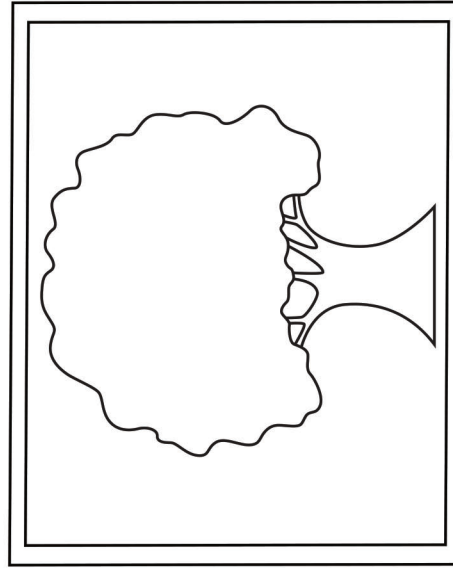

A Tree

Deep Down Detective Devotion: Unit 13, Bible Truth 5, Lesson 3



Big Question 13: Why Do God's People Keep Believing in Him?

Answer: It Is God's Sustaining Grace... God Uses His People to Strengthen and Comfort Each Other!

Bible Truth 5 Meaning

When your body is hungry you feed it food. The food makes your body strong to do what you need it to do. But did you know that the spirit God put inside our bodies needs to be fed, too? Not hamburgers or hot dogs, but a spiritual kind of food. What is this spiritual food? It's the Word of God, the Bible. When God's people read God's Word, the Holy Spirit uses it to feed their spirits. He uses it to help them know God better, to guide them in God's will, and to give them strength to do whatever God wants them to do. And just like our bodies work best if we feed them each day, God's people know that it is best for their spirits if they read and think about God's Word every day. They know that God uses His Word to sustain them, even through the most difficult times. We can become God's people, too, when we turn away from our sins and trust in Jesus as our Savior. Then, God will use His Word to help us to keep on loving and living for Him, too.

How do I know this is true? The Bible tells me so!

"For whatever was written in former days was written for our instruction, that through endurance and through the encouragement of the Scriptures we might have hope." --Romans 15:4, ESV

Some Questions for You

1. What happened when Epaphras listened to Paul preach God's Word? *The Holy Spirit worked powerfully in his heart. He believed God's Word, turned away from his sins, and trusted in Jesus as his Savior.*
2. Where did Epaphras go after he went to Ephesus? *Epaphras went back home to Colossae.*
3. What did the people in Colossae think when they heard the good news of Jesus? *Many believed it. They turned away from their sins and trusted in Jesus as their Savior.*
4. What did the new believers in Colossae start? Why? *A little church. They did that to worship God and love one another. They wanted to hear God's Word so they could know God and live for Him more.*
5. What did Epaphras hope and pray that God's Word would do inside of the believers in Colossae? *He hoped that it would change them from their old way of life. He hoped it would help them love God and live for Him.*
6. Why did some people in the little church in Colossae want everyone to keep the old rules and the old ways that had nothing to do with God's Word or Jesus? *They were still scared the Jesus might not be enough to protect them from bad things they were afraid of.*
7. Who did Epaphras go see to help him know how to care for these new believers and stop the bad teachers from the wrong things they were doing? *Epaphras travelled to Rome to see Paul.*
8. What did Paul write in the letter he sent with Epaphras back to the believers of Colossae? *He told them that they did not need to keep the old special rules or wear magic stones to keep safe from the evil things they feared. Jesus had beaten all those bad things when He died on the cross. Paul told them to keep on learning God's Word and let it work in their hearts. They should remind each other of the good things written in God's Word and even sing them in their songs.*
9. What happened to the believers in Colossae after they read Paul's letter to them? *Some continued to have a hard time with what the bad teachers taught, but many heard Paul's words and were helped. They depended on what God's Word told them about Jesus, not on the old special rules or old, magic stones.*
10. What was the good news that Paul preached from God's Word and changed Epaphras ... and can change ask, too? *That Jesus is the Savior God sent to save us from our sins. When we turn away from our sins and trust in Jesus as our Savior, God forgives us our sins and makes it His people forever. God can help us do this, too.*

Let's Pray!

- A** God, we praise You for being the Giver of Your Word, the Bible.
- C** We confess that many times we don't want to read Your Word or live by it. We need a Savior!
- T** Thank You for promising to use Your Word, the Bible, to strengthen Your people and help them to know You and love You better. Thank You for using it to help them keep on believing in You and living for You.
- S** God, use Your Word to help us to turn away from our sins and trust in Jesus as our Savior. Help us to know You and love You better as we read it. Send Your Holy Spirit to work in our hearts, helping us to understand Your Word and live it out.

Let's Praise God Right Now!

Big Q & A 13 Hymn: Jesus Paid It All

from *Deep Down Detectives ESV Songs 13, track 17*

Verse 1

I hear the Savior say,
"Thy strength indeed is small,
Child of weakness, watch and pray,
Find in Me thine all in all!"

Words: Elvina M. Hall Music: John T. Grape

Refrain

Jesus paid it all,
All to Him I owe;
Sin had left a crimson stain,
He washed it white as snow.

Go to the *Deep Down Detectives Parent Resources for Unit 13* to get the Bible story and many more resources and songs for this unit at praisefactory.org

Big Question 13 Praise Song: I Will Sing of the Mercies

from *Deep Down Detectives ESV Songs 13, track 18*

I will sing of the mercies of the Lord forever,
I will sing, I will sing,
I will sing of the mercies of the Lord forever,
I will sing of the mercies of the Lord.
With my mouth will I make known
Thy faithfulness, Thy faithfulness,
With my mouth will I make known
Thy faithfulness to all generations.

CAN YOU GUESS Bible Truth 6:

Why Do God's People Keep Believing in Him? It Is God's Sustaining Grace...

God Uses His ----- to Strengthen and Comfort Each Other!

HINT: This word is another word for lots of men, women, boys and girls. It starts with a "p" and it rhymes with "Steeple."

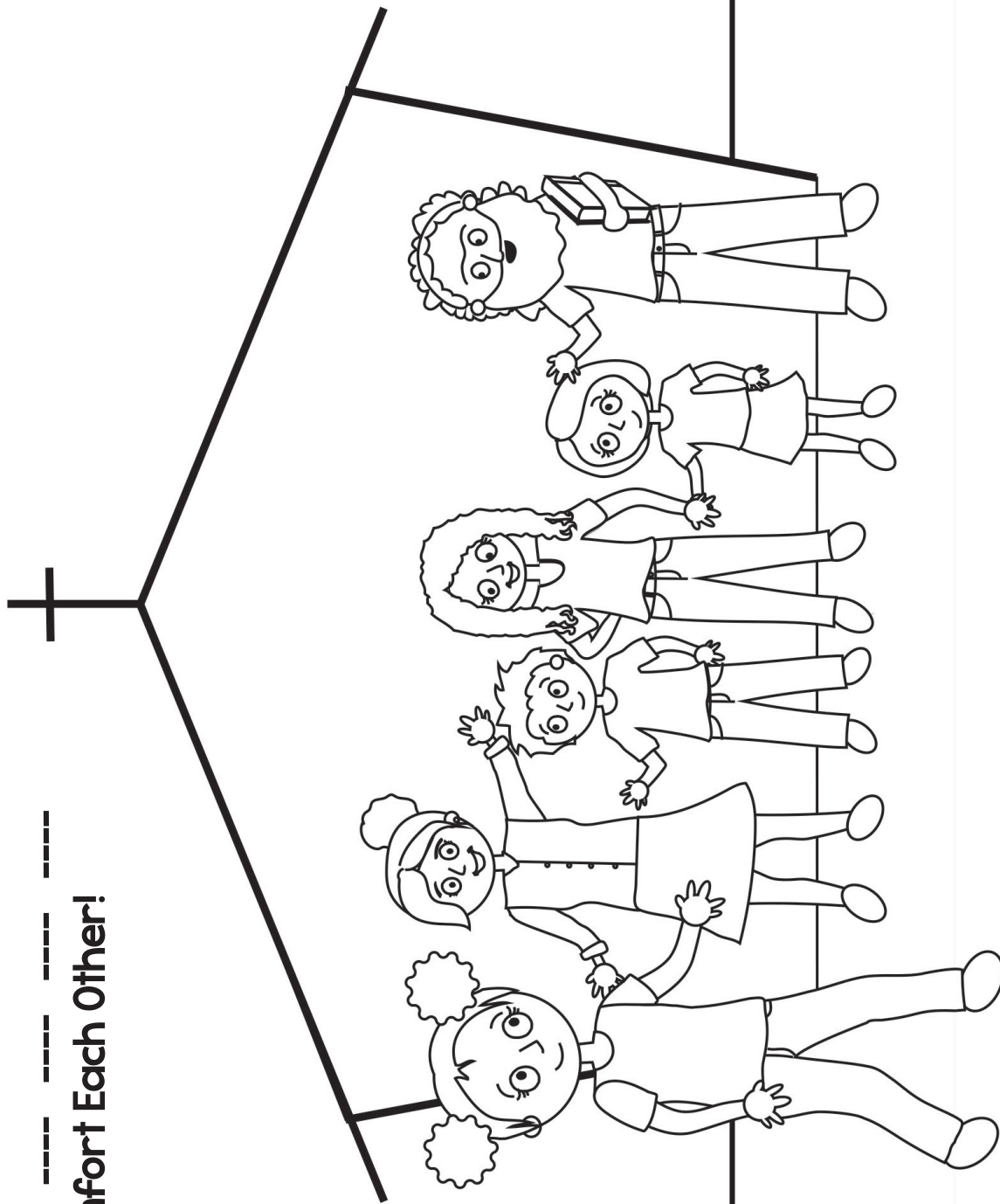

Deep Down Detective Devotion: Unit 13, Bible Truth 6, Lesson 1



Big Question 13: Why Do God's People Keep Believing in Him?

Answer: It Is God's Sustaining Grace... God Uses His People to Strengthen and Comfort Each Other!

Bible Truth 6 Meaning

No matter who we are, we all go through times of need. Sometimes, we are learning something new, and we need help learning how to do it. Sometimes, we are going through something that is very sad or very hard, and we need comfort and strength. God loves to help His people all the time, especially in their times of need. He uses His Word, the Bible, to guide and comfort them. His Holy Spirit strengthens them inside their heart. But God also helps His people through their prayers and comfort for each other. God's people comfort each other by reminding one another that God is always with them and how great and good He is. They read the Bible to each other and hold on to His wonderful promises to take care of them. They pray for each other, asking God to give them wisdom, strength, and joy; and, to rescue them from their troubles. They ask God to use their hard and sad times for their good and to bring glory to His name. God loves to sustain His people through their comfort and prayers for one another. It is a wonderful display of His love both to His people and to others who watch how God's people love and care for one another. We, too, can become God's people when we turn from our sins and trust in Jesus as our Savior. Then, He can use us to comfort others in this special way, too.

How do I know this is true? The Bible tells me so!

"Blessed be the God and Father of our Lord Jesus Christ, the Father of mercies and God of all comfort, who comforts us in all our affliction, so that we may be able to comfort those who are in any affliction, with the comfort with which we ourselves are comforted by God... On him we have set our hope that he will deliver us again. You also must help us by prayer, so that many will give thanks on our behalf for the blessing granted us through the prayers of many." --2 Corinthians 1:3-4,10-11, ESV

Some Questions for You

1. Who goes through sad and hard times? *We all do!*
2. Who needs comfort and strength in those times? *We all do.*
3. How does God help His people in these sad and hard times? *He uses His Word, the Bible, to guide and comfort them. His Holy Spirit strengthens them inside their hearts.*
4. How does God use His people to help each other in sad and hard times? *He uses them to comfort and pray for each other.*
5. How do God's people use the Bible to strengthen and comfort each other? *They read the Bible to each other and remind each other of God's wonderful promises to take care of them.*
6. How do God's people pray for each other when they are going through sad and hard times? *They ask God to give them strength and joy. They ask God to rescue them from their troubles. They ask God to use the hard and sad times to make them more like Jesus and to show everybody what a great God He is.*
7. What do others say about God when God's people comfort each other? *They tell what God's love for His people is like. It helps them want to know God, too.*
8. How can we become God's people? *By turning away from our sins and trusting in Jesus as our Savior.*

Let's Pray

- A** God, we praise You for being the Comforter and Strength of Your People. You help them comfort and strengthen each other.
- C** We confess that many times we forget to pray for others who are struggling with hard or sad times. Many times, we don't take time to comfort and strengthen others who are struggling. We need a Savior!
- T** Thank You, God, for the comfort God's people receive from You through how they help and pray for each other.
- S** Work in our hearts that we might turn away from our sins and trust in Jesus as our Savior. Help us to comfort others with Your Word and by praying for them. Use us to help others in their times of need. Help others to see Your love and kindness as we comfort and pray for each other. In Jesus' name we pray, Amen.

Let's Sing about What We're Learning!

Go to the Deep Down Detectives Parent Resources for Unit 13 to get the Bible story and many more resources and songs for this unit at praisefactory.org.

Big Q & A 13 Song from *Deep Down Detectives ESV Songs 13, track 12* (adapted version of "On Top of Old Smoky")

Why do God's people keep believing in God?
And why do God's people keep living for Him?
Because God sustains them, yes, God alone,
That's why God's people keep believing in God.

Big Question 13 Action Rhyme Song from *Deep Down Detectives ESV Songs 13, track 13*

Why Do God's People Keep Believing in Him?
Why do God's people keep believing in Him?
What keeps them going? Why do they persevere?
There's just one reason for their lasting faith,
It is grace, God's sustaining grace.

Refrain

That's why God's people say:
"I'm gonna keep on believing in God,
I'm gonna keep on living for Him,
Yes, I'm gonna keep on believing in God,
And It's all thanks to Him, thanks to Him.

God sustains His people in many ways,
His Spirit works inside them
As they read His Word and pray,
He gives them faith
to keep in trusting in Him,
To keep on living for Him
to the very end. *Refrain*



"Blessed be the God and Father of our Lord Jesus Christ, the Father of mercies and God of all comfort, who comforts us in all our affliction, so that we may be able to comfort those who are in any affliction, with the comfort with which we ourselves are comforted by God..."

On him we have set our hope that he will deliver us again.

You also must help us by prayer, so that many will give thanks on our behalf for the blessing granted us through the prayers of many." --2 Corinthians 1:3-4,10-11, ESV

Deep Down Detective Devotion: Unit 13, Bible Truth 6, Lesson 2



Big Question 13: Why Do God's People Keep Believing in Him?

Answer: It Is God's Sustaining Grace... God Uses His People to Strengthen and Comfort Each Other!

How do I know this is true? The Bible tells me so!

"Blessed be the God and Father of our Lord Jesus Christ, the Father of mercies and God of all comfort, who comforts us in all our affliction, so that we may be able to comfort those who are in any affliction, with the comfort with which we ourselves are comforted by God... On him we have set our hope that he will deliver us again. You also must help us by prayer, so that many will give thanks on our behalf for the blessing granted us through the prayers of many."

--2 Corinthians 1:3-4,10-11, ESV

Learn a Little: "We comfort those in any affliction, with the comfort we are comforted by God."

Meaning:

God loves His people so much! He is full of mercy and compassion. He cares about their sadnesses and troubles, and He comforts them. Many times, God uses His people to comfort each other. They listen to each other. They encourage each other and pray. They remind each other of God's promises. They help each other turn away from disobeying God. No wonder God's people praise Him for giving them each other! He uses them to show His love to each other and to keep on believing in Him their whole lives. We can become God's people when we turn away from our sins and trust in Jesus as our Savior.

Some Questions for You

1. Who comforts God's people in all of their afflictions (sad and hard times)? Why? *God does. God comforts His people in sad and hard times because he cares for them; but also, because He wants them to use the comfort He gives them to comfort others when they need it.*
 2. Who does God want His people to comfort? *He wants them to comfort other people, especially God's people.*
 3. Who do God's people hope in when they need help? *They hope in God to help them and deliver them.*
 4. Who do God's people comfort by praying for them? *They pray for other people, especially God's people.*
- How can we become God's people? *By turning away from our sins and trusting in Jesus as our Savior.*

Let's Pray!

- A** God, we praise You for being the Comforter and Strength of Your People. You help them comfort and strengthen each other.
- C** We confess that many times we forget to pray for others who are struggling with hard or sad times. Many times, we don't take time to comfort and strengthen others who are struggling. We need a Savior!
- T** Thank You, God, for the comfort God's people receive from You through how they help and pray for each other.
- S** Work in our hearts that we might turn away from our sins and trust in Jesus as our Savior. Help us to comfort others with Your Word and by praying for them. Use us to help others in their times of need. Help others to see Your love and kindness as we comfort and pray for each other. In Jesus' name we pray, Amen.

Let's Sing Our Bible Verse!

Blessed Be the God and Father: 2 Corinthians 1:3-4, ESV from *Deep Down Detectives* ESV Songs 13, track 37

Blessed be the God and Father of our Lord Jesus Christ,
Blessed be the God and Father of our Lord Jesus Christ,
The Father of mercies and God of all comfort,
Blessed be the God, blessed be the God,
Blessed be the God and Father of our Lord Jesus Christ.

Which four of these clues belong in our story? Which two do not? Put an X in the boxes of the four that belong.

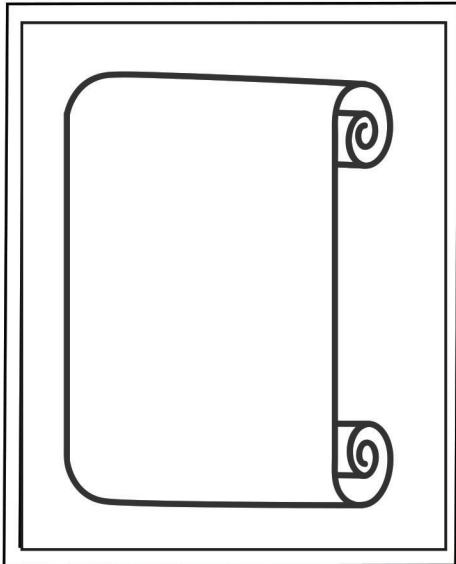

A Letter

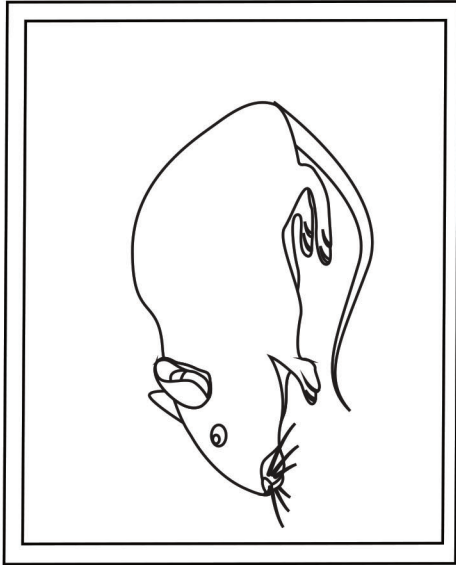

A Mouse

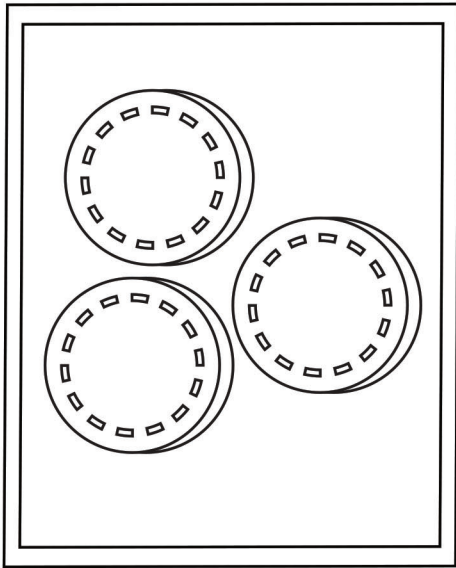

Some Money

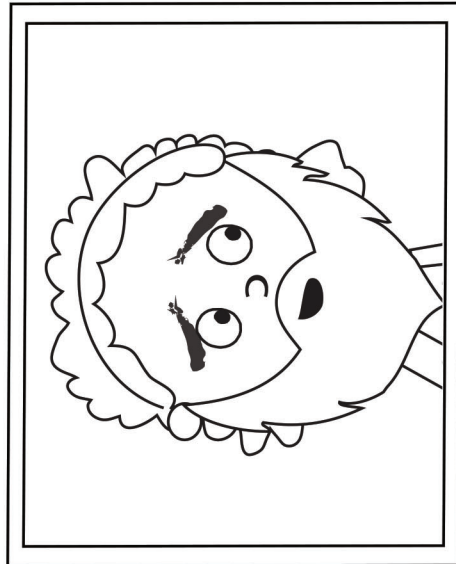

Epaphroditus

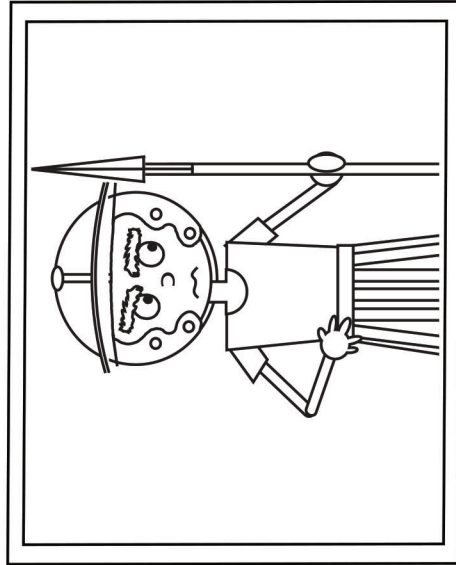

A Soldier

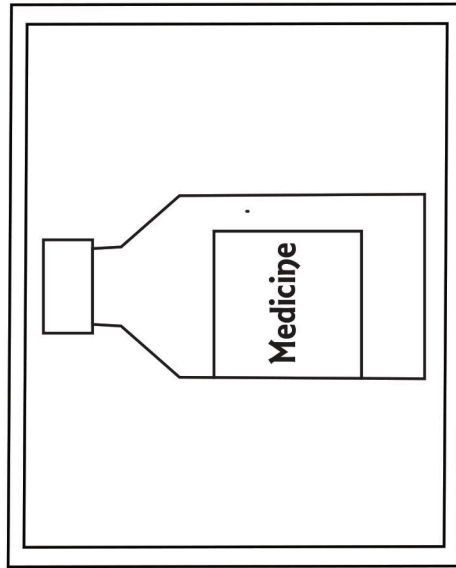

Some Medicine

Answer: The bad teacher, God's Word, a magic stone, and the "bad" food belong. The rabbit and the tree do not.

Deep Down Detective Devotion: Unit 13, Bible Truth 6, Lesson 3



Big Question 13: Why Do God's People Keep Believing in Him?

Answer: It Is God's Sustaining Grace... God Uses His People to Strengthen and Comfort Each Other!

Bible Truth 6 Meaning

No matter who we are, we all go through times of need. Sometimes, we are learning something new, and we need help learning how to do it. Sometimes, we are going through something that is very sad or very hard, and we need comfort and strength. God loves to help His people all the time, especially in their times of need. He uses His Word, the Bible, to guide and comfort them. His Holy Spirit strengthens them inside their heart. But God also helps His people through their prayers and comfort for each other. God's people comfort each other by reminding one another that God is always with them and how great and good He is. They read the Bible to each other and hold on to His wonderful promises to take care of them. They pray for each other, asking God to give them wisdom, strength, and joy; and, to rescue them from their troubles. They ask God to use their hard and sad times for their good and to bring glory to His name. God loves to sustain His people through their comfort and prayers for one another. It is a wonderful display of His love both to His people and to others who watch how God's people love and care for one another. We, too, can become God's people when we turn from our sins and trust in Jesus as our Savior. Then, He can use us to comfort others in this special way, too.

How do I know this is true? The Bible tells me so!

"Blessed be the God and Father of our Lord Jesus Christ, the Father of mercies and God of all comfort, who comforts us in all our affliction, so that we may be able to comfort those who are in any affliction, with the comfort with which we ourselves are comforted by God... On him we have set our hope that he will deliver us again. You also must help us by prayer, so that many will give thanks on our behalf for the blessing granted us through the prayers of many." --2 Corinthians 1:3-4,10-11, ESV

Some Questions for You

1. What was the exciting news that everyone was talking about in Jerusalem? *That Jesus had rose from the dead.*
2. Who did Jesus appear to after God Uses His People to Strengthen and Comfort Each Other? *His friends... one time even 500 of them at once!*
3. What did Jesus do with His friends after God Uses His People to Strengthen and Comfort Each Other? *He ate and drank with them. He showed them everything the Bible had to say about Him. He taught them more of God's plans for the world.*
4. Where did Jesus tell His friends He was going? *Back home to heaven to be with God His Father and the Holy Spirit. And, to be the great King of Kings and rule over everything.*
5. Who did Jesus promise to send His friends? *The Holy Spirit, to teach them more about God, to comfort them in their hearts and to give them power to do everything God wanted them to do.*
6. What did Jesus want His friends to do? *Tell the whole world how they could be saved by turning away from disobeying God and trusting in Jesus as their Savior.*
7. How did Jesus go to heaven? *He rose up in the sky.*
8. How will Jesus come back one day? *He will come back in the same way He left.*
9. What is Jesus doing in heaven even now? *He is ruling as the great King of Kings, praying and caring for God's people. And, bringing about all of God's good plans for this world.*

Let's Pray

- A** God, we praise You for being the Comforter and Strength of Your People. You help them comfort and strengthen each other.
- C** We confess that many times we forget to pray for others who are struggling with hard or sad times. Many times, we don't take time to comfort and strengthen others who are struggling. We need a Savior!
- T** Thank You, God, for the comfort God's people receive from You through how they help and pray for each other.
- S** Work in our hearts that we might turn away from our sins and trust in Jesus as our Savior. Help us to comfort others with Your Word and by praying for them. Use us to help others in their times of need. Help others to see Your love and kindness as we comfort and pray for each other. In Jesus' name we pray, Amen.

Let's Praise God Right Now!

Big Q & A 13 Hymn: Jesus Paid It All

from *Deep Down Detectives* ESV Songs 13, track 17

Verse 1

I hear the Savior say,
"Thy strength indeed is small,
Child of weakness, watch and pray,
Find in Me thine all in all!"

Refrain

Jesus paid it all,
All to Him I owe;
Sin had left a crimson stain,
He washed it white as snow.

Words: Elvina M. Hall Music: John T. Grape
And give Him the glory, great things He hath done.

Big Question 13 Praise Song: I Will Sing of the Mercies

from *Deep Down Detectives* ESV Songs 13, track 18

I will sing of the mercies of the Lord forever,
I will sing, I will sing,
I will sing of the mercies of the Lord forever,
I will sing of the mercies of the Lord.
With my mouth will I make known
Thy faithfulness, Thy faithfulness,
With my mouth will I make known
Thy faithfulness to all generations.