

**CAN YOU GUESS BIBLE TRUTH 4:
How Should God's People Live?
They Should Live Like Jesus...**

By Trusting God and Being

**-----
with What He Wants!**

**HINT: What is the opposite of being sad?
It starts with an "H" and it rhymes
with "snappy."**

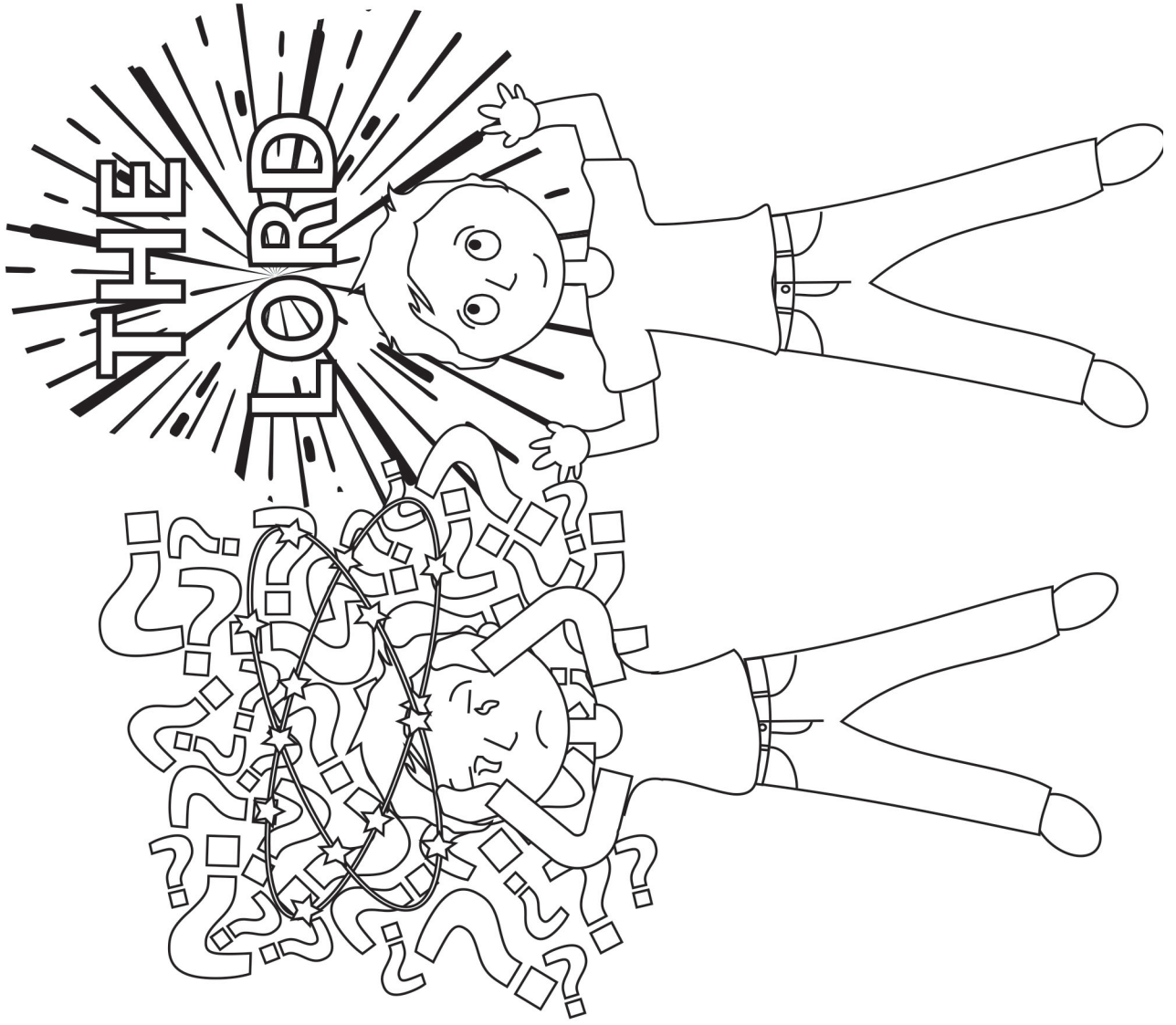

Deep Down Detective Devotion: Unit 12, Bible Truth 4, Lesson 1



Big Question 12 : How Should God's People Live?

Answer: They Should Live Like Jesus... By Trusting God and Being Happy with What He Wants!

Bible Truth 4 Meaning

Jesus trusted God, His Father, completely. He knew that what His Father wanted Him to do was always best. He knew His Father would always give Him strength to do whatever He wanted Him to do. Sometimes His Father's plans were very hard, but Jesus knew that His plans were still always best. God wants His people to trust Him like Jesus did. God promises to always take care of them. He promises that even all the sad or bad things they go through, He will use to do good things. He promises to always give them the Holy Spirit to give them the strength to do what He wants them to do. Sometimes it is very hard for God's people to keep trusting God and His plans. Sometimes they want to grumble or be mad at God because of what happens to them. But God wants them to keep on trusting Him, even in those very hard times. He wants them to be happy and keep on believing that He is doing what is best for them. He wants them to keep trusting that He will show Himself to be the good and great God He is. For indeed, God IS so very good and great; and, what He has planned is always best! We can become God's people who trust God, too, when we turn away from our sins and trust in Jesus as our Savior.

How do I know this is true? The Bible tells me so!

"Trust in the LORD with all your heart, and do not lean on your own understanding. In all your ways acknowledge him, and he will make straight your paths." -- Proverbs 3:5- 6, ESV

Some Questions for You

1. Who did Jesus trust completely? *God, His Father.*
2. What did Jesus think about what God, His Father, wanted Him to do? *That it was always best.*
3. Who did Jesus know would give Him strength to do whatever God wanted Him to do? *God, His Father.*
4. Who should trust God like Jesus did? *God's people.*
5. Who does God always promise to take care of? *His people.*
6. What does God promise to do with all the sad and bad things His people go through? *To use them to do good things.*
7. Who does God promise to give to His people to help them? *The Holy Spirit.*
8. How does God want His people to act about what happens to them? *He wants them not to grumble or get mad, but keep trusting Him and be happy that what He plans is best.*
9. How can we become God's people? *By turning away from our sins and trusting Jesus as our Savior.*

Let's Pray!

- A** God, we praise You for always being good and deserving of our trust. You are always wise and perfect in everything You do and plan.
- C** God, please forgive us for not trusting You when things happen that we don't like or don't understand. Many times, we start doubting that You know what is best when we should keep on trusting You. We need a Savior!
- T** Thank You, God, for always doing what is best. Thank You that we can always trust You and be happy with what You allow in our lives. Even if we don't understand, we know You do.
- S** God, please work in our hearts. Help us turn away from our sins and trust in Jesus as our Savior. Help us to love You. Help us to trust You with everything in our lives. Help us to be happy with what You choose, even when it is hard and even when we don't understand. In Jesus' name we pray, Amen.

Let's Sing about What We're Learning!

Big Q & A 12 Song from Deep Down Detectives ESV Songs 12, track 12 (sung to the tune of "Twinkle, Twinkle, Little Star")

How should God's people live each day? They should live like Jesus!
 How should God's people live each day? How should God's people live each day?
 How should God's people live each day? They should live like Jesus!

Big Question 12 Action Rhyme Song from Deep Down Detectives ESV Songs 12, track 13

Refrain:

How should God's people live?
 How should God's people live?
 How should God's people live?
 They should live like Jesus!

Point up to God in heaven

Verse 1

Jesus loved God most of all,
 He loved all people, too,
 In all that He did

Touch heart, then point up to God in heaven

and said and thought,
 He loved them thru and thru. *Refrain*

*Point out to others
 Touch heart*

Verse 2

God's people should love God
 most of all,
 They should love others, too,
 And God the Holy Spirit,
 Will help them in all they do.

*Point up to God in heaven
 Point out to others*

Touch heart

Refrain

Go to the Deep Down Detectives Parent Resources for Unit 12 to get the Bible story and many more resources and songs for this unit at praisefactory.org.

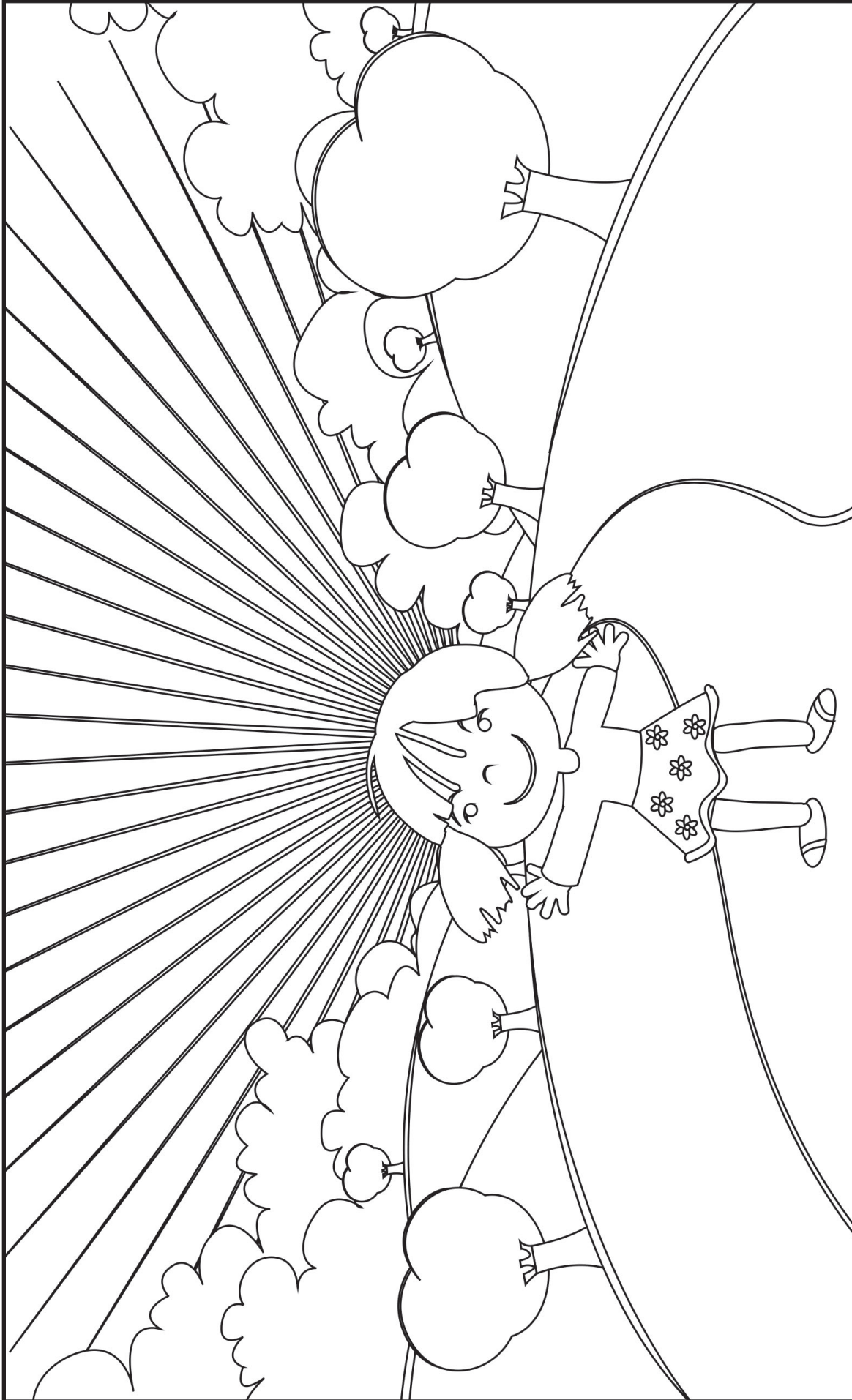

**“Trust in the LORD with all your heart, and do not lean on your own understanding.
In all your ways acknowledge him, and he will make straight your paths.”**

-- Proverbs 3:5- 6, ESV

Deep Down Detective Devotion: Unit 12, Bible Truth 4, Lesson 2



Big Question 12 : How Should God's People Live?

Answer: They Should Live Like Jesus... By Trusting God and Being Happy with What He Wants!

How do I know this is true? The Bible tells me so!

"Trust in the LORD with all your heart, and do not lean on your own understanding. In all your ways acknowledge him, and he will make straight your paths." -- Proverbs 3:5- 6, ESV

Learn a Little: "Trust in the LORD with all your heart."

Meaning

These verses remind us that we can always trust the LORD and His good plans, even when we don't understand what He is doing. He wants us not to depend on ourselves or what we see, but on Him, His Word, and His good plans. And when we do, we can know that He will show us what He wants us to do, every day of our lives.

Some Questions for You

1. Who can we always trust? *The LORD.*
2. Does God still have good plans, even when we don't understand them? *Yes, He does!*
3. What book tells us of God's good plans and promises? *The Bible.*
4. When we trust in the LORD with our lives, what can we know He will show us each day? *What He wants us to do. How He wants us to live.*
5. What is the best, first step we should take if we want to trust in the LORD? *We can ask God to help us to turn away from our sins and trust in Jesus as our Savior. He loves to answer these prayers!*

Let's Pray!

- A** We praise You, God, that You are the great and awesome God. There is no god like you. You are everywhere, all the time. You see everything there is to see. You are always with us.
- C** God, You are always with us. Nothing is hidden from You. We know You see us disobey You every single time. We need a Savior! Please forgive us through Jesus!
- T** Thank You, God, for always being with us wherever we are. Thank You that even when we feel very alone, You are there. We can always turn to You and ask You for help.
- S** Help us to turn away from our sins and trust in Jesus as our Savior. Help us to live to please You as You watch us. Help us to depend on You to take care of us. In Jesus' name we pray, Amen.

Let's Sing Our Bible Verse!

Trust: Proverbs 3:5-6 from *Deep Down Detectives ESV Songs 12, track 26*

Trust in the LORD,
Trust in the LORD,
Trust in the LORD with all your heart,
And do not lean,
And do not lean,
On your own understanding,
In all your ways, acknowledge Him,
In all your ways acknowledge Him,
And He will make straight your paths,
And He will make straight your paths.
Proverbs Three, five and six.

Which four of these clues belong in our story? Which two do not? Put an X in the boxes of the four that belong.

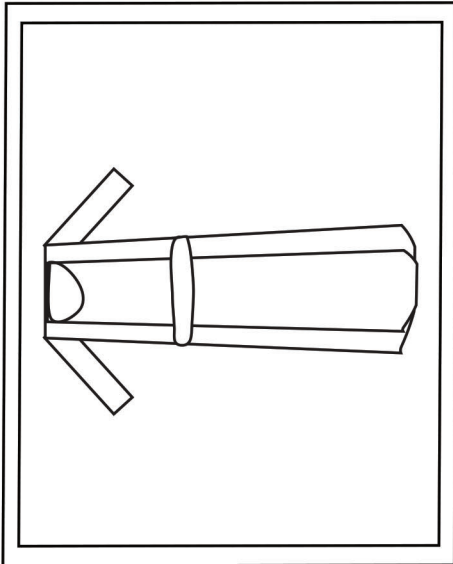

Rich Clothes

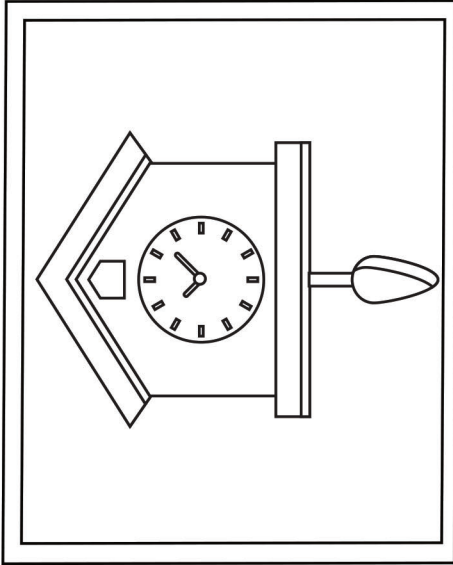

A Clock

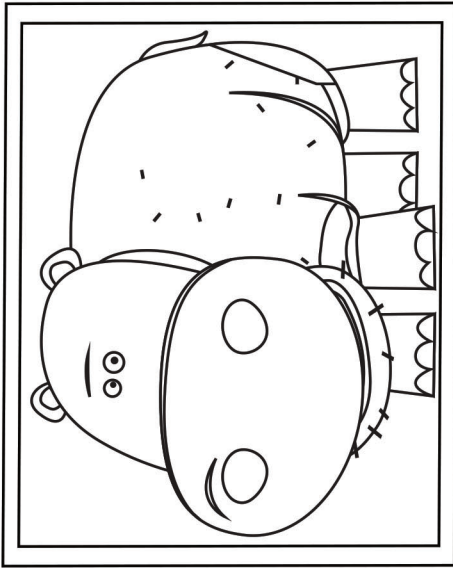

A Hippo

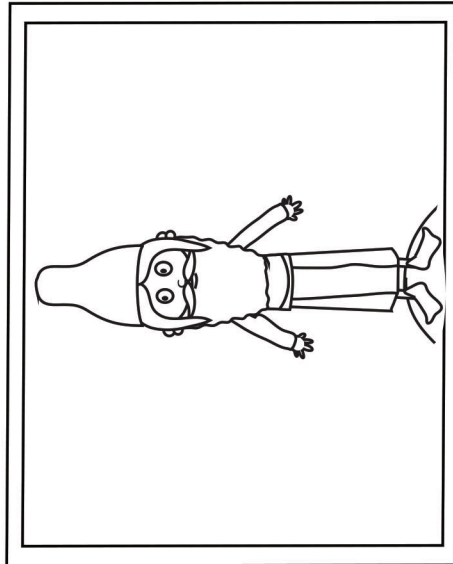

A Big Statue

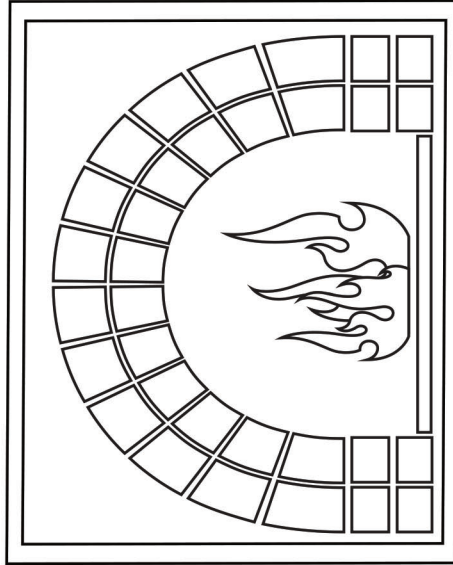

A Hot Fire

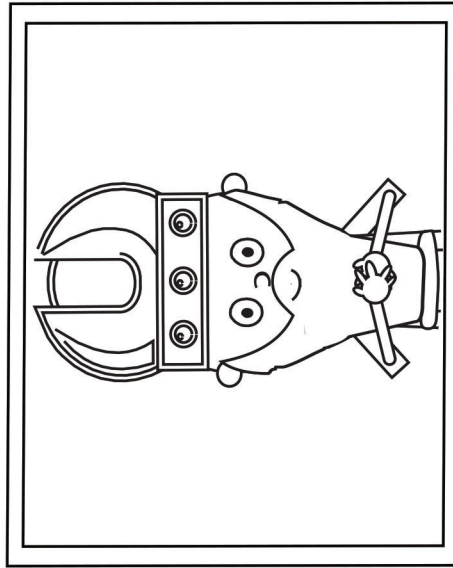

A Mighty King

Answer: The rich clothes, the big statue, the hot fire, and the mighty king belong. The clock and the hippo do not.

Deep Down Detective Devotion: Unit 12, Bible Truth 4, Lesson 3



Big Question 12 : How Should God's People Live?

Answer: They Should Live Like Jesus... By Trusting God and Being Happy with What He Wants!

Bible Truth 4 Meaning

Jesus trusted God, His Father, completely. He knew that what His Father wanted Him to do was always best. He knew His Father would always give Him strength to do whatever He wanted Him to do. Sometimes His Father's plans were very hard, but Jesus knew that His plans were still always best. God wants His people to trust Him like Jesus did. God promises to always take care of them. He promises that even all the sad or bad things they go through, He will use to do good things. He promises to always give them the Holy Spirit to give them the strength to do what He wants them to do. Sometimes it is very hard for God's people to keep trusting God and His plans. Sometimes they want to grumble or be mad at God because of what happens to them. But God wants them to keep on trusting Him, even in those very hard times. He wants them to be happy and keep on believing that He is doing what is best for them. He wants them to keep trusting that He will show Himself to be the good and great God He is. For indeed, God IS so very good and great; and, what He has planned is always best! We can become God's people who trust God, too, when we turn away from our sins and trust in Jesus as our Savior.

How do I know this is true? The Bible tells me so!

"Trust in the LORD with all your heart, and do not lean on your own understanding. In all your ways acknowledge him, and he will make straight your paths." -- Proverbs 3:5- 6, ESV

Some Questions for You

1. What was the name of the mighty king of Babylon? *King Nebuchadnezzar.*
2. Why were Shadrach, Meshach, and Abednego marching to King Nebuchadnezzar's home? *They had been captured and were being made to work for their enemies in their home city.*
3. What did Shadrach, Meshach, and Abednego remember that helped them trust God as their enemies took them away? *They remembered God's promises.*
4. Why did King N. want to make Shadrach, Meshach, and Abednego his helpers and give them lots of nice things? *So they would forget the LORD and their own land.*
5. What did King N want everyone to bow down to? *A great, golden idol.*
6. What happened to Shadrach, Meshach, and Abednego when they didn't bow down? *They were taken to the king and given another chance to worship the idol, but they would not do it.*
7. Why did Shadrach, Meshach, and Abednego keep on trusting in the LORD and were willing to be thrown into the fiery furnace? *They knew the LORD was the one, true God. They know He could save them, if it was His good and perfect will.*
8. What happened to Shadrach, Meshach, and Abednego when they were thrown into the fire? *They were not burned up, but protected by God. They were joined by an angel (maybe Jesus).*
9. What did King N. say when he saw that the LORD had protected Shadrach, Meshach, and Abednego? *He proclaimed the LORD to be the Most High God and should be honored by all peoples.*
10. What is the best first step God wants us to take in learning to trust Him, like Shadrach, Meshach, and Abednego did? *We can ask God to help us to turn away from our sins and trust in Jesus as our Savior. He loves to answer these prayers!*

Let's Pray!

- A** We praise You, God, that You are the great and awesome God. There is no god like you. You are everywhere, all the time. You see everything there is to see. You are always with us.
- C** God, You are always with us. Nothing is hidden from You. We know You see us disobey You every single time. We need a Savior! Please forgive us through Jesus!
- T** Thank You, God, for always being with us wherever we are. Thank You that even when we feel very alone, You are there. We can always turn to You and ask You for help.
- S** Help us to turn away from our sins and trust in Jesus as our Savior. Help us to live to please You as You watch us. Help us to depend on You to take care of us. In Jesus' name we pray, Amen.

Let's Praise God Right Now!

Big Q & A 12 Hymn: Trust and Obey, v.1

from *Deep Down Detectives ESV Songs 12, track 16*

Verse 1

When we walk with the Lord,
In the light of His Word,
What a glory He sheds on our way!
While we do His good will;
He abides with us still,
And with all who will trust and obey.

Refrain

Trust and obey,
For there's no other way,
To be happy in Jesus,
But to trust and obey.

Big Question 12 Praise Song:

I Have Decided to Follow Jesus

from *Deep Down Detectives ESV Songs 12, track 17*

I have decided to follow Jesus,
I have decided to follow Jesus,
I have decided to follow Jesus,
No turning back, no turning back.

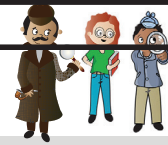
**The Case of the Faith that Faced Fire***Daniel 1-3*

Dear Parents,

Big Question #12 is: "How Should God's People Live?" Your child is learning that They Should Live Like Jesus...By Trusting God and Being Happy with What He Wants!"

Here's a copy of the Bible story they are learning along with the "Listening Assignment" for each lesson. These assignments provide a different teaching emphasis for each lesson, helping the children dig deeper into each Bible truth. They match up with your child's take home for each lesson. We hope that these resources help your family to dig down deeper into the truths of God's Word!" Happy digging!

•many more resources for this Big Question can be found online at www.praisefactory.org•

Listening Assignments

"Hey, Kids! Detective Dan, here. Listen carefully to the story and help me answer these questions:

Detective Dan's Lesson #1 Listening Assignment:

I need to find out:

- 1. Who did the king order to be thrown into the fire?**
- 2. What did God give them faith to do?**

Detective Dan's Lesson #2 Listening Assignment:**Our Bible Verse is Proverbs 3:5-6:**

"Trust in the LORD with all your heart, and do not lean on your own understanding. In all your ways acknowledge him, and he will make straight your paths."

I need to find out:

- 1. Who had to trust in the Lord in ways far bigger than they could understand?**
- 2. How did the Lord show his faithfulness to them?**

Detective Dan's Lesson #3 Listening Assignment:

I found six clues, but only 4 of them are in the story.

They are: rich clothes, a clock, a hippo, a big statue, a hot fire, and a mighty king. *Hold each of them up for the children to see as you identify them.*

I need to figure out:

- 1. Which four belong in our story?**
- 2. Who chose to praise the Lord and keep worshiping him even when it almost cost them their lives?**

Read the assignment questions, THEN SAY,

"Ok, Deep Down Detectives! Put on your best listening ears and see if you can hear the answers to Detective Dan's questions. When I finish telling the story, we will see if we can answer all the questions."

Read the Bible Truth story, answer questions, present the gospel and lead in prayer.

Answers to questions; the gospel; and, ACTS prayer are included with the story text.

The Case of the Faith that Faced Fire *Daniel 1-3**Story with lines separating paragraphs (text in bold, optional interaction cues in italics)*

“March, march, march!” Enemy soldiers marched into Jerusalem. They tore down the Temple. They burned up the city. And now, they were forcing Shadrach, Meshach, Abednego, and many others to leave Jerusalem and go far away to Babylon to be their slaves.

Shadrach, Meshach, and Abednego were sad to leave their home and work for their enemies; but, they remembered the LORD’s messages through His prophets Isaiah, Jeremiah and Ezekiel.

“You people of Judah have kept on disobeying Me and worshipping fake gods. I’ve been patient for a long time. I’ve warned you and urged you to change, but you still disobey Me. Now, I will let your enemies attack you and take you away to work for them in Babylon,” the LORD told them. **“I’m punishing you that you might turn from your sins and return to Me.”**

“Don’t be afraid. I’ll take care of you. I’ll be with you. I’ll change your hearts with my Spirit, so you’ll want to obey Me. I’ll bring you back home to Judah,” He comforted them. **“And best of all, one day, I’ll send a Savior to save you from your sins. So, trust in Me! Be happy with what I want! I am the LORD, the great, one, true God,”** the LORD promised them.

Shadrach, Meshach, and Abednego held onto the LORD’s promises. They chose to trust in Him and be happy with what He wanted, even though they had to live far away in Babylon and work for their enemies.

Now, there was a mighty king who ruled over Babylon. He had a BIG name. Are you ready for it? It’s King Nebuchadnezzar!

Can you say Nebuchadnezzar?

King Nebuchadnezzar had a helper named Ashpenaz. Ashpenaz had a very important job. He was supposed to pick out the smartest, most handsome, young men from among the slaves and teach them to be new helpers for King Nebuchadnezzar. When Ashpenaz looked among the people of Judah for the smartest, most handsome, young men, who do you think he picked?

Can you guess who?

He picked Shadrach, Meshach, and Abednego!

“Come with me. You’re the kind of men King Nebuchadnezzar wants for his new helpers,” Ashpenaz told them. **“You are to go to the King’s helper school. You’ll eat the best food and wear the finest robes and hats,”** Ashpenaz told them. **“You’ll learn about mighty King Nebuchadnezzar and the great gods of Babylon. Then, you’ll work in the king’s beautiful palace and help him make good decisions,”** Ashpenaz explained.

Story with lines separating paragraphs (text in bold, optional interaction cues in italics)

Wow! What a good life King Nebuchadnezzar was offering Shadrach, Meshach, and Abednego! The best food to eat, the finest robes and hats to wear, and the honor of working in the rich palace of the mighty king, himself! What could be better than this?

What food do you think is the best food? What would it be like to work for a mighty king?

But Shadrach, Meshach, and Abednego knew the truth. King Nebuchadnezzar was being tricky! He was giving them all these nice things so they would forget their home, the LORD, and the Bible, God's Word. Nebuchadnezzar wanted them to honor him and his fake gods instead!

And what would happen to Shadrach, Meshach, and Abednego if they didn't honor King Nebuchadnezzar and his fake gods? They were soon to find out.

What do you think? What would the king do?

King Nebuchadnezzar was very proud of himself. "I am the greatest king on earth! Look at all the lands I've captured and all the people I've made into my workers," he boasted.

"I'm going to make a great, golden statue for everyone to worship," he decided. "Then, everyone will honor me and serve the great gods I worship."

King Nebuchadnezzar ordered his workers to get started. "Build me a great, golden statue. Make it as high as a tall building. Put it where everyone can gather around it and worship it," the king told them.

The workers obeyed the king. They built the great, golden statue, just as the king ordered. And when it was finished, oh, how tall it was! And oh, how golden it was! It was amazing!

Then, King Nebuchadnezzar sent word to all the people: "When the musicians play their music, you are to fall down and worship the golden statue. This shows you honor me and serve my gods," he said.

"But if anyone refuses to worship, I'll have him thrown straight into a hot, fiery furnace," the king warned.

No one wanted to be thrown into the furnace and die. So, when the musicians played their music, Everyone was quick to obey. They all fell down before the statue and worshipped.

All, that is, except for three men.

Can you guess who the three were?

Shadrach, Meshach, and Abednego!

Story with lines separating paragraphs (text in bold, optional interaction cues in italics)

Yes, these three men **REFUSED** to fall down and worship that great, golden statue. The LORD was the only God they worshipped. He alone was the one, true God, and Shadrach, Meshach, and Abednego knew it. They weren't going to stop worshipping the LORD, even though the king threatened to throw them in a fiery furnace. So, there they stood while everyone else bowed down, sure that someone would notice.

Someone did notice! They went straight to the king with the news. "Shadrach, Meshach, and Abednego don't care about you or your gods," they exclaimed. "They refuse to fall down and worship your great, golden statue," they told the king.

Nebuchadnezzar was furious! He ordered Shadrach, Meshach, and Abednego to be brought before him. "Listen to the music and fall down before my great, golden statue. Show me that you worship the statue and serve my gods," he ordered. "Do it now or be thrown into the fiery furnace! Furnace! Then, what god can rescue you?" the king demanded.

Was the king right? Was there really no god who could rescue them?

What do you think?

But, there **WAS** a god who could rescue them. It was the LORD! (SB33) Shadrach, Meshach, and Abednego knew it and they remembered the LORD's promises to them. They would keep on worshipping Him. They would trust in Him alone.

They said to the king, "King Nebuchadnezzar, you're wrong. The LORD, the God whom we serve, can deliver us from your hot, fiery furnace if He wants to. And even if He doesn't choose to rescue us, we'll keep on worshipping Him and we'll still be happy with what He wants," they told the king. "The LORD is the one, true God and He knows what is best!"

King Nebuchadnezzar was even more furious! Shadrach, Meshach, and Abednego were still refusing to bow down and worship his great, golden statue. Now, they would have to die. "Add more wood to the fire! Make it seven times hotter! Tie up these men and throw them in!" the king ordered.

Soon, the fire was raging hot. It was so hot that the king's mighty men died from the heat as they threw Shadrach, Meshach, and Abednego into the flames.

What do you think happened to them?

This should have been the end of Shadrach, Meshach, and Abednego, but it wasn't. King Nebuchadnezzar looked into the fiery furnace and was amazed. There were Shadrach, Meshach, and Abednego walking around in the furnace and the flames didn't burn them up. And strangest of all, was the shining, heavenly person with them, protecting them from the fire with God's great power. (Some people think it was an angel, but others think it was Jesus.)

King Nebuchadnezzar could hardly believe his eyes! "Come out of the fire," the king ordered the men. Shadrach, Meshach, and Abednego obeyed. They walked through the flames and out of that hot furnace. They stood before the king, without a burn on their skin or the smell of smoke on their clothes! Amazing!

Story with lines separating paragraphs (text in bold, optional interaction cues in italics)

King Nebuchadnezzar knew there was only one reason why Shadrach, Meshach, and Abednego were not killed or even hurt in that fiery, hot furnace.

Do you know what it was?

It was because the LORD their God really WAS the great, one, true God!! He was to be trusted and worshipped, just like Shadrach, Meshach, and Abednego had said!

No longer did the king want anyone to bow down before his great, golden statue. It was great. It was golden. But it was NOT God! Now the king had a NEW God he wanted everyone to worship--the one, true God. Can you tell me His name?

Can you tell me?

It was the LORD! So, the king sent out a new announcement, "Praise to the God of Shadrach, Meshach, and Abednego. They trusted in Him rather than worship my great, golden statue. He sent His angel to rescue them. These men deserve to be great leaders in my kingdom; and the LORD, their God, deserves all peoples in my kingdom to honor Him," the king declared. "What a great God He is!" And King Nebuchadnezzar was right!

Cracking the Case: (story wrap-up for Listening Assignments)

It's time to see how we did with our Listening Assignment.

Detective Dan's Lesson 1 Listening Assignment:**1. Who did the king order to be thrown into the fire?**

Shadrach, Meshach, and Abednego.

2. What did God give them faith to do? To NOT bow down to the golden statue, but to keep believing and trusting in Him with their whole lives.

For You and Me:

Like Shadrach, Meshach, and Abednego, the LORD wants us to trust Him and be happy with what He wants, even when it is very hard. The LORD is always good, and His plans are always right, even if we don't understand them. And, He promises to always help His people keep trusting in Him, no matter what. How can we become God's people? By turning away from our sins and trusting in Jesus as our Savior. Ask Him to help you trust in Jesus as your Savior, and to help you trust Him with every day of your life! He loves to answer these prayers!

Detective Dan's Lesson 2 Listening Assignment:**Our Bible Verse is Proverbs 3:5- 6, ESV:**

"Trust in the LORD with all your heart, and do not lean on your own understanding. In all your ways acknowledge him, and he will make straight your paths."

1. Who had to trust in the LORD in ways far bigger than they could understand? Shadrach, Meshach, and Abednego.

2. How did the LORD show His faithfulness to them? He helped them to NOT bow down to the golden statue, but to keep on believing and trusting in Him with their whole lives. He protected them from dying in the fiery furnace, too.

For You and Me:

The LORD can always be trusted. He is always up to good. His plans are always perfect. And because He is so much bigger and greater than us, there will be many times when we don't understand the good things He's up to. That's why God's people are told not to lean on their own understanding, but to keep trusting in the LORD. The LORD knows they can't do this on their own. They need His help. And He is happy to give it! He will always give His people everything they need to keep trusting in Him and be happy with what He wants.

We can become God's people, too, when we turn away from our sins and trust in Jesus as our Savior. Then, God will help us trust Him and be happy with what He wants for our lives, too.

Detective Dan's Lesson 3 Listening Assignment:

Our six clues were: rich clothes, a clock, a hippo, a big statue, a hot fire, and a mighty king.

1. Which four belong in our story?

The rich clothes, the big statue, the hot fire, and the mighty king belong.

2. Who chose to praise the Lord and keep worshiping him even when it almost cost them their lives?

Shadrach, Meshach, and Abednego.

For You and Me

Like Shadrach, Meshach, and Abednego, the LORD wants us to trust Him and be happy with what He wants, even when it is very hard. The LORD is always good, and His plans are always right, even if we don't understand them. And, He promises to always help His people keep trusting in Him, no matter what. How can we become God's people? By turning away from our sins and trusting in Jesus as our Savior. Ask Him to help you trust in Jesus as your Savior, and to help you trust Him with every day of your life! He loves to answer these prayers!

The Gospel (story wrap-up if NOT using Listening Assignments)**Our Bible Truth is:****How Should God's People Live?****They Should Live Like Jesus...****By Trusting God and Being Happy with What He Wants!**

Shadrach, Meshach, and Abednego were right to trust in the LORD and be happy with what He wanted. The LORD kept all His promises to them and to the people of Israel, for He DID take care of them; He WAS with them. He DID change their hearts; and, He DID bring them back home. And best of all, He DID send His Son, Jesus, to save all who would ever turn away from their sins and trust in Him as their Savior.

Yes, Jesus came and lived a perfect life that pleased God. On the cross, He offered it up to God as the perfect payment for the sins of all who would ever turn away from their sins and trust in Him as their Savior. Jesus suffered and died for God's people that day. But on the third day, He rose up from the grave in victory. He really had beaten sin and death for God's people!

This gift of salvation can be ours, too, when we turn away from our sins and trust in Jesus, He will save us from our sins, too. And we, too, can trust Him and be happy with what He wants, every day of our lives, just like Shadrach, Meshach, and Abednego did.

Close in prayer.

Closing ACTS Prayer

- A** God, we praise You for always being good and deserving of our trust. You are always wise and perfect in everything You do and plan.

- C** God, please forgive us for not trusting You when things happen that we don't like or don't understand. Many times, we start doubting that You know what is best when we should keep on trusting You. We need a Savior!

- T** Thank You, God, for always doing what is best. Thank You that we can always trust You and be happy with what You allow in our lives. Even if we don't understand, we know You do.

- S** God, please work in our hearts. Help us turn away from our sins and trust in Jesus as our Savior. Help us to love You. Help us to trust You with everything in our lives. Help us to be happy with what You choose, even when it is hard and even when we don't understand.

In Jesus' name we pray, Amen.

Big Question 12, Bible Truth 4 Overview: Key Concepts

p.1

Unit 12: God's People Live for Him

Unit Big Question (and Answer): How Should God's People Live? They Should Live Like Jesus!

Unit Bible Verse: "Be imitators of God, as beloved children. And walk in love, as Christ loved us and gave himself up for us." --Ephesians 5:1-2, ESV

Bible Truth 4 Concept: They Should Live Like Jesus... By Trusting God and Being Happy with What He Wants!

Jesus trusted God, His Father, completely. He knew that what His Father wanted Him to do was always best. He knew His Father would always give Him strength to do whatever He wanted Him to do. Sometimes His Father's plans were very hard, but Jesus knew that His plans were still always best.

God wants His people to trust Him like Jesus did. God promises to always take care of them. He promises that even all the sad or bad things they go through, He will use to do good things. He promises to always give them the Holy Spirit to give them the strength to do what He wants them to do.

Sometimes it is very hard for God's people to keep trusting God and His plans. Sometimes they want to grumble or be mad at God because of what happens to them. But God wants them to keep on trusting Him, even in those very hard times. He wants them to be happy and keep on believing that He is doing what is best for them. He wants them to keep trusting that He will show Himself to be the good and great God He is. For indeed, God IS so very good and great; and, what He has planned is always best!

We can become God's people who trust God, too, when we turn away from our sins and trust in Jesus as our Savior.

Bible Truth 4 Bible Verse: Proverbs 3:5- 6, ESV

"Trust in the LORD with all your heart, and do not lean on your own understanding. In all your ways acknowledge him, and he will make straight your paths."

Learn a Little: "Trust in the LORD with all your heart."

Meaning

These verses remind us that we can always trust the LORD and His good plans, even when we don't understand what He is doing. He wants us not to depend on ourselves or what we see, but on Him, His Word, and His good plans. And when we do, we can know that He will show us what He wants us to do, every day of our lives.

Bible Truth 4 ACTS Prayer

- A** God, we praise You for always being good and deserving of our trust. You are always wise and perfect in everything You do and plan.
- C** God, please forgive us for not trusting You when things happen that we don't like or don't understand. Many times, we start doubting that You know what is best when we should keep on trusting You. We need a Savior!
- T** Thank You, God, for always doing what is best. Thank You that we can always trust You and be happy with what You allow in our lives. Even if we don't understand, we know You do.
- S** God, please work in our hearts. Help us turn away from our sins and trust in Jesus as our Savior. Help us to love You. Help us to trust You with everything in our lives. Help us to be happy with what You choose, even when it is hard and even when we don't understand. In Jesus' name we pray, Amen.

Big Question 12, Bible Truth 4 Overview: Key Concepts

p.2

Bible Truth 4 Story

The Case of the Faith that Faced Fire *Daniel 1-3*

Songs Used in Bible Truth 4

Big Q & A 12 Song

Big Question 12 Song: How Should God's People Live?

Big Question 12 Bible Verse Song: Walk in Love Ephesians 5:1-2, ESV

Extra Big Question 12 Bible Verse Song: Let Everyone Who Names the Name 2 Timothy 2:19,22, ESV

Big Question 12 Hymn: Trust and Obey, v.1

Big Question 12 Praise Song: I Have Decided to Follow Jesus

Bible Truth 4 Bible Verse Song: Trust Proverbs 3:5-6, ESV

Extra Bible Truth 4 Bible Verse Song: Trust in the LORD Proverbs 3:5-6, ESV

Extra Bible Truth 4 Bible Verse Song: May the God of Hope Romans 15:13, NIV 1984

Extra Bible Truth 4 Bible Verse Song: Let the Morning Bring Me Psalm 143:5,8, NIV 1984

Extra Bible Truth 4 Bible Verse Song: For a Little While 1 Peter 1:6-7, NIV 1984

Extra Bible Truth 4 Bible Verse Song: Many Walk as Enemies Philippians 3:18,19,20, ESV

Extra Bible Truth 4 Bible Verse Song: You Were Publicly Exposed Hebrews 10:32-36, ESV

listen to or download songs for free at <https://praisefactory.org>: Deep Down Detectives Music page