

**CAN YOU GUESS BIBLE TRUTH 3:  
What Are God's Laws Like?  
God's Laws Are Perfect...**

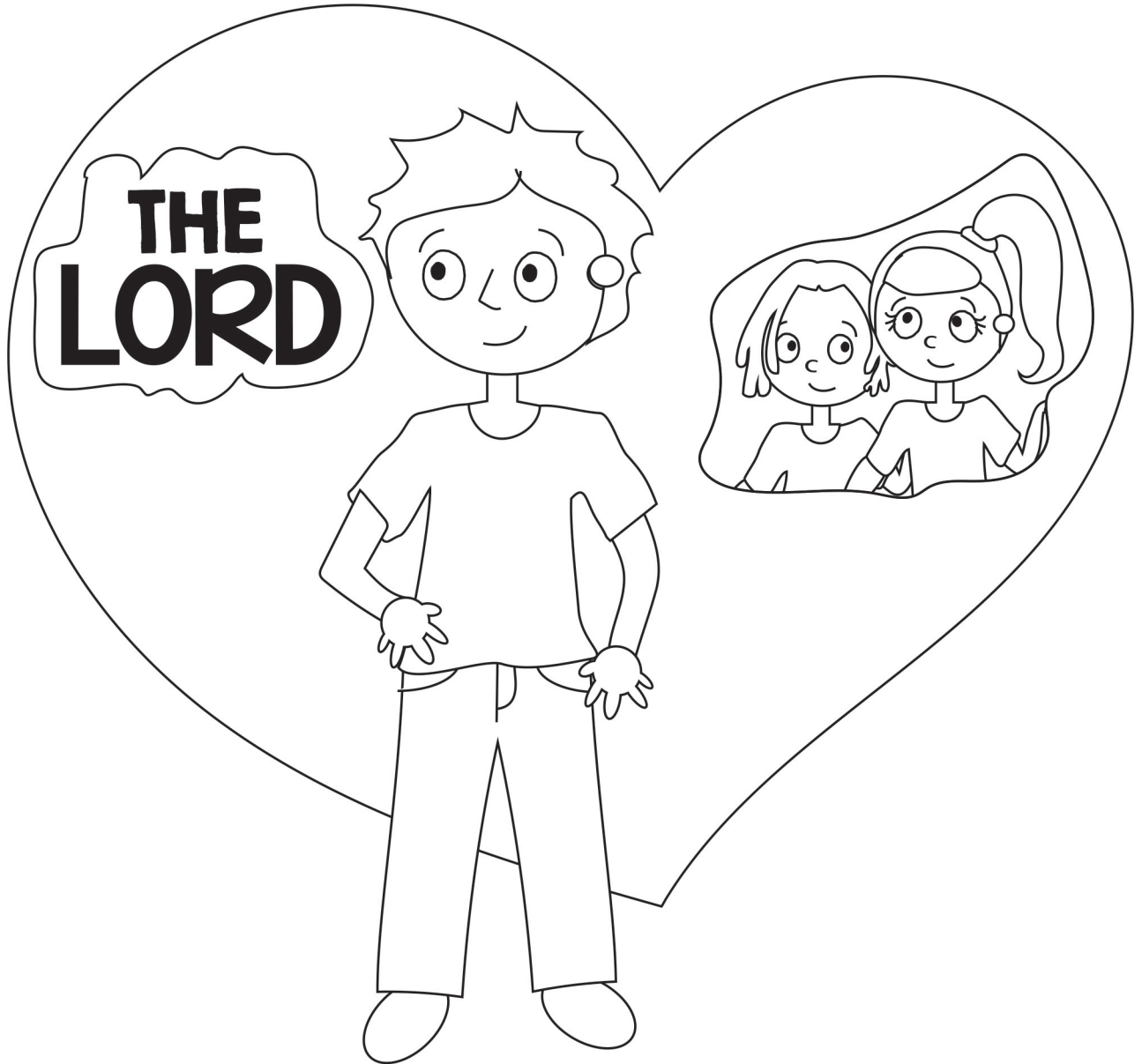

**They tell us how to ----- God and others!**

**HINT: How does God want us to want towards Himself and others?  
It starts with an "L" and it rhymes with "dove."**

# Deep Down Detective Devotion: Unit 7, Bible Truth 3, Lesson 1



**Big Question 7:** What Are God's Laws Like?

**Answer:** God's Laws Are Perfect... They Tell Us How to Love God and Others!

## Bible Truth 3 Meaning

The LORD is the one, true God. He deserves our love. He made us to love Him more than anything else. Loving God is the most delightful thing we can do. God gave us His laws so we can know how to love Him. When we obey His laws, we are living out our love for Him. God made us not just to love Him, but also to love each other. He gave His laws so we can know how to love each other. He tells us to treat others in the same loving way we want others to treat us. When we obey God's laws, we are living out God's love for others. And, we are showing them a little bit of what God is like, that they might seek to know and love Him, too. Obeying God's laws is not just the right way to live. It is also the happiest way to live with God and with other people. God can help us obey His laws and live in love when we turn away from our sins and trust in Jesus as our Savior. He gives us a new heart filled with His Holy Spirit and helps us to live in love as He wants us to.

## How do I know this is true? The Bible tells me so!

"You shall love the Lord your God with all your heart and with all your soul and with all your mind. This is the great and first commandment. And a second is like it: You shall love your neighbor as yourself. On these two commandments depend all the Law and the Prophets."—Matthew 22:37-40, ESV

## Some Questions for You

1. Who is the only true God? *The LORD.*
2. Who did the LORD make us to love more than anything or anyone else? *Himself!*
3. What is the most delightful thing we can do? *Love God.*
4. Who does God's laws show us how to love? *How to love Him and how to love others.*
5. How should we treat others? *In the same loving way we want others to treat us.*
6. What is the right way to live? *Obeying God's laws as He tells us to.*
7. What is the happiest way to live with God and other people? *Obeying God's laws.*
8. Who can help us to love God and others? *God can. He can help us turn away from our sins and trust in Jesus as our Savior. He can send the Holy Spirit to live in our hearts and help us to love Him and others as He wants us to.*

## Let's Pray!

- A** We praise You, God, for being the Giver of Your perfectly good laws that tell us how to love You and others.
- C** God, many times, we do not obey Your good laws. Many times, we do not love You or others as Your laws tell us to. We need a Savior!
- T** Thank You, God, for giving us Your good laws that show us how to love You and others. Thank You for sending Your Holy Spirit to live in our hearts when we trust in Jesus as our Savior. He helps us to obey Your good and loving laws.
- S** God, work in our hearts. Help us to turn away from our sins and trust in Jesus as our Savior. Send Your Holy Spirit to live inside our hearts and help us to love You and others as You want us to. In Jesus' name we pray, Amen.

## Let's Sing about What We're Learning!

**Big Q & A 7 Song** from *Deep Down Detectives ESV Songs 7, track 12*  
(adapted version of "The Farmer in the Dell")

What are God's laws like?  
What are God's laws like?  
What are God's laws like?  
God's laws are perfect!

**Big Question 7 Action Rhyme Song** from *Deep Down Detectives ESV Songs 7, track 13*

### Refrain:

What are God's laws like?  
What are they like?  
God's laws are perfect!  
God's laws are perfect!  
What are God's laws like?  
What are they like?  
God's laws are like Him,  
They are good and just.

### Verse 1

God is our Creator,  
He's in charge of the whole world.  
He gave us laws to live by,  
They are written in His Word.  
*Refrain*

### Verse 2

God's laws are the best way,  
For us all to live,  
God calls us to obey them,  
To reflect His righteousness. *Refrain*

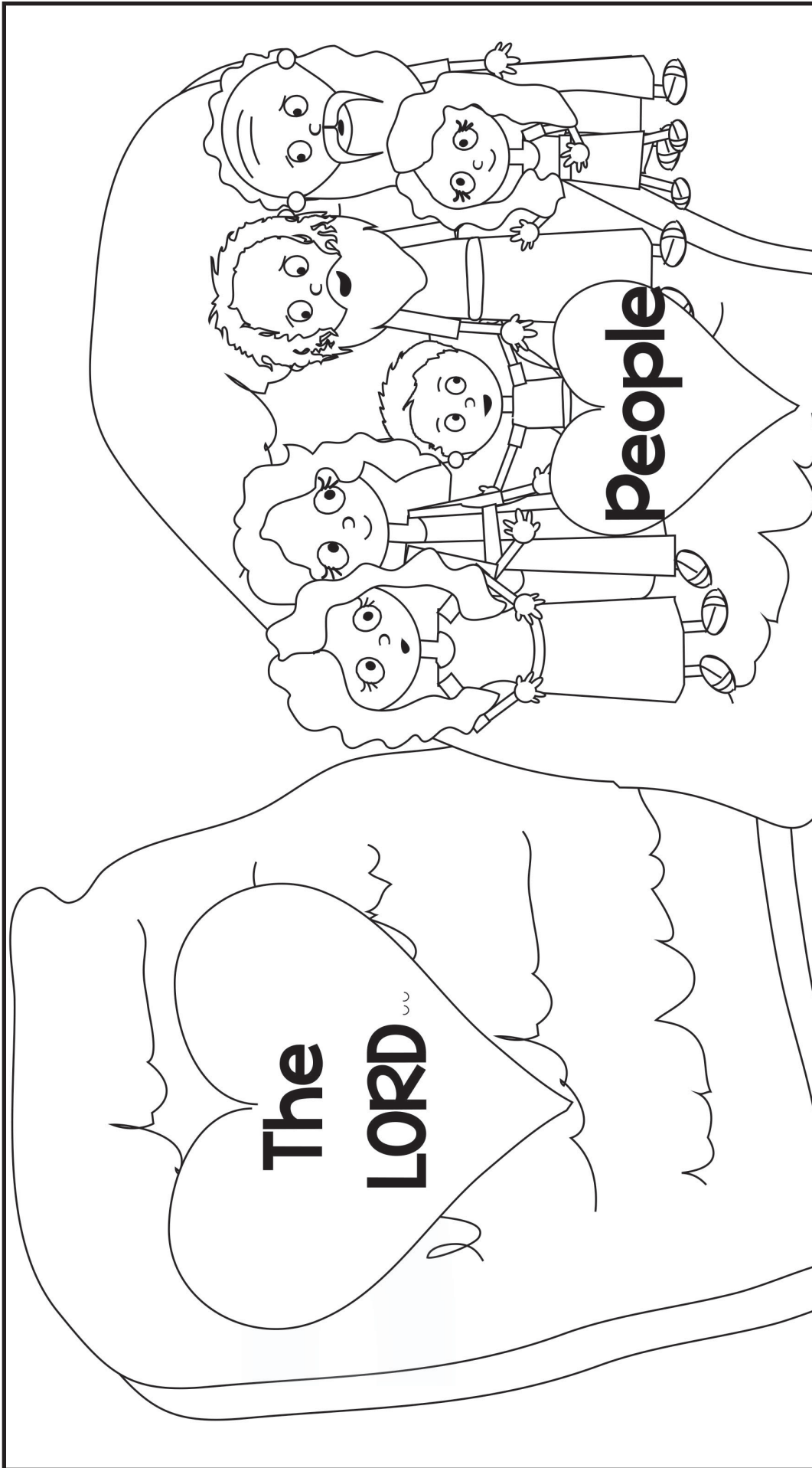

**“You shall love the Lord your God with all your heart and with all your soul and with all your mind.**

**This is the great and first commandment.**

**And a second is like it: You shall love your neighbor as yourself.**

**On these two commandments depend all the Law and the Prophets.”**

**Matthew 22:37-40, ESV**

## Deep Down Detective Devotion: Unit 7, Bible Truth 3, Lesson 2



**Big Question 7:** What Are God's Laws Like?

**Answer:** God's Laws Are Perfect... They Tell Us How to Love God and Others!

**How do I know this is true? The Bible tells me so!**

"You shall love the Lord your God with all your heart and with all your soul and with all your mind. This is the great and first commandment. And a second is like it: You shall love your neighbor as yourself. On these two commandments depend all the Law and the Prophets."--Matthew 22:37-40, ESV

**Learn a Little:** "Love the Lord your God with all your heart, soul and mind... Love your neighbor as yourself."

**Meaning**

God has given us many laws in the Bible. It's good to know them all. But Jesus tells us in these verses that the purpose behind all of God's laws is to love God most of all, and to love others as we love ourselves. When we live out all His good laws, we are loving God and love others as He wants us to.

**Some Questions for You**

1. What did Jesus say was the first and greatest law? *To love God most of all.*
2. What did Jesus say was the second most important law of God that we should all obey? *To love others in the same loving way as we want others to treat us.*
3. What two laws did Jesus say sum up all of the other laws that God has given us? *To love God most of all, and love others in the same loving way as we want others to treat us.*
4. Who can help us to love God and others? *God can. He can help us turn away from our sins and trust in Jesus as our Savior. He can send the Holy Spirit to live in our hearts and help us to love Him and others as He wants us to.*

**Let's Pray!**

- A** We praise You, God, for being the Giver of Your perfectly good laws that tell us how to love You and others.
- C** God, many times, we do not obey Your good laws. Many times, we do not love You or others as Your laws tell us to. We need a Savior!
- T** Thank You, God, for giving us Your good laws that show us how to love You and others. Thank You for sending Your Holy Spirit to live in our hearts when we trust in Jesus as our Savior. He helps us to obey Your good and loving laws.
- S** God, work in our hearts. Help us to turn away from our sins and trust in Jesus as our Savior. Send Your Holy Spirit to live inside our hearts and help us to love You and others as You want us to. In Jesus' name we pray, Amen.

**Let's Sing Our Bible Verse!**

**Love the Lord: Matthew 22:37-40** from *Deep Down Detectives ESV Songs 7, track 27*

Love the Lord your God with all your heart,  
Love the Lord your God with all your soul,  
Love the Lord your God with all your mind,  
This is the first and greatest commandment.

*And the second is like it...*

Love your neighbor as yourself,  
Love your neighbor as yourself,  
Love your neighbor as yourself,  
On these two commandments depend,  
All the Law and Prophets.  
Matthew Twenty-two, thirty-seven through forty.

Go to the *Deep Down Detectives Parent Resources for Unit 7* to get the Bible story and many more resources and songs for this unit at [praisefactory.org](http://praisefactory.org)

DDD BQ 7 BT3 L2 Coloring Sheet/Take Home pg2

Which four of these clues belong in our story? Which two do not? Put an X in the boxes of the four that belong.

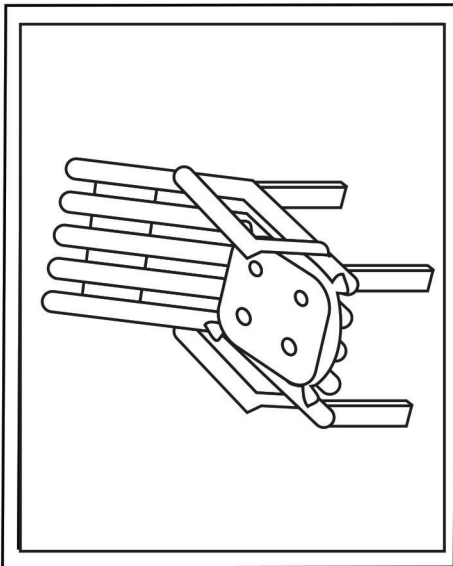

A Pillow

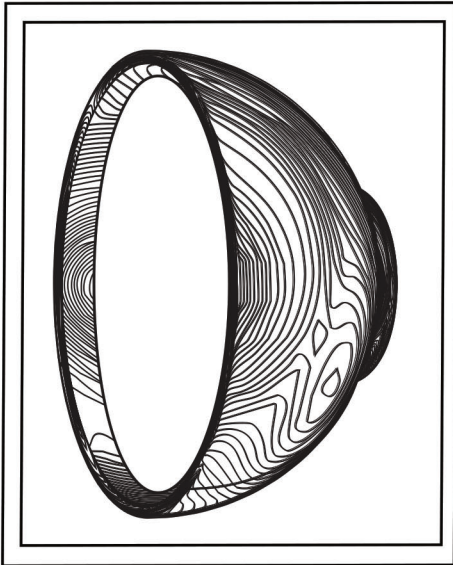

A Cup

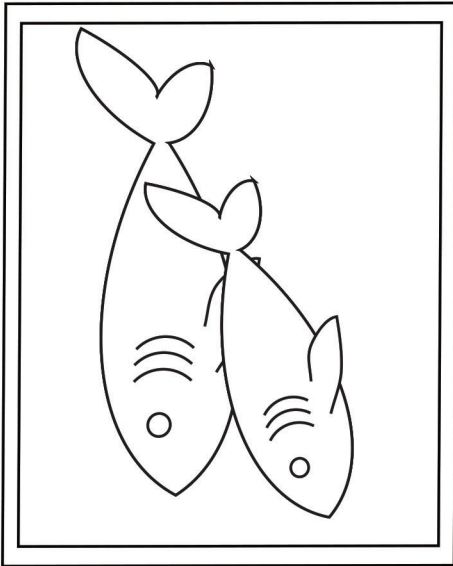

Two Fish

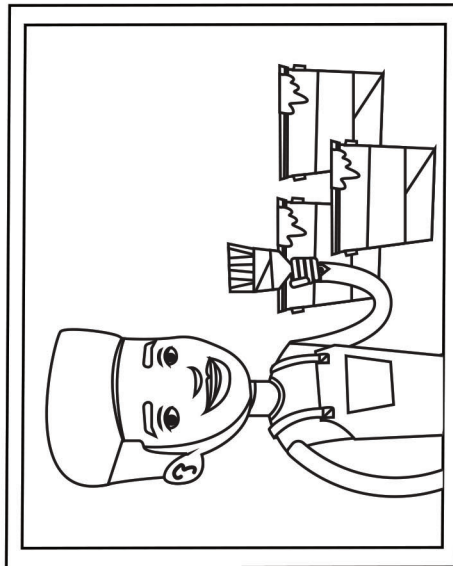

A Dead Person

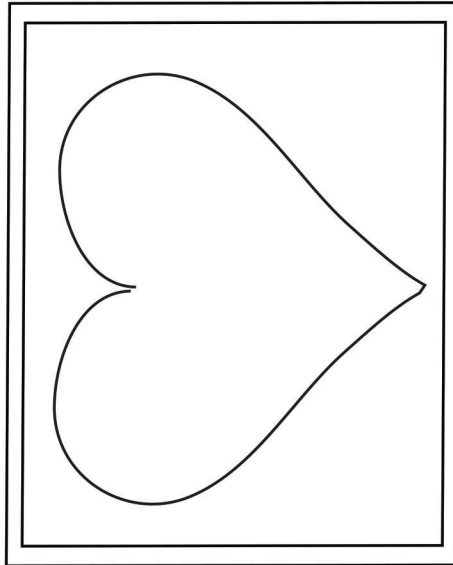

A Heart

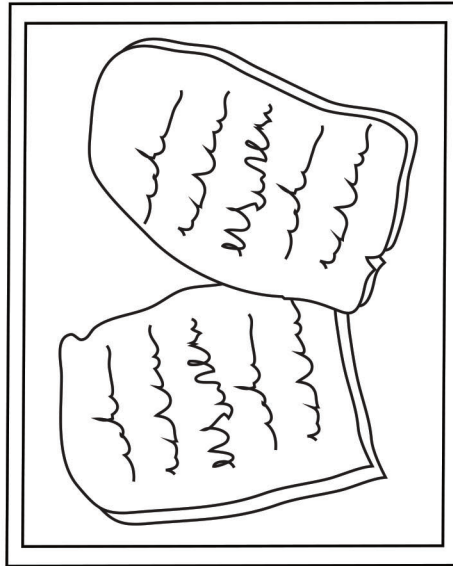

God's Ten, Big Laws

Answer: The cup, the fish, the heart and God's Ten, Big Laws. The painter and the pillow do not.

## Deep Down Detective Devotion: Unit 7, Bible Truth 3, Lesson 3



### Big Question 7: What Are God's Laws Like?

**Answer:** God's Laws Are Perfect... They Tell Us How to Love God and Others!

### Bible Truth 3 Meaning

The LORD is the one, true God. He deserves our love. He made us to love Him more than anything else. Loving God is the most delightful thing we can do. God gave us His laws so we can know how to love Him. When we obey His laws, we are living out our love for Him. God made us not just to love Him, but also to love each other. He gave His laws so we can know how to love each other. He tells us to treat others in the same loving way we want others to treat us. When we obey God's laws, we are living out God's love for others. And, we are showing them a little bit of what God is like, that they might seek to know and love Him, too. Obeying God's laws is not just the right way to live. It is also the happiest way to live with God and with other people. God can help us obey His laws and live in love when we turn away from our sins and trust in Jesus as our Savior. He gives us a new heart filled with His Holy Spirit and helps us to live in love as He wants us to.

### How do I know this is true? The Bible tells me so!

"You shall love the Lord your God with all your heart and with all your soul and with all your mind. This is the great and first commandment. And a second is like it: You shall love your neighbor as yourself. On these two commandments depend all the Law and the Prophets."--Matthew 22:37-40, ESV

### Some Questions for You

1. What is the name of the Ten, Big Laws that God gave to show us how to love God and others? *The Ten Commandments.*
2. Did the teachers in Jesus' day tell people to keep just the 10 Commandments and other laws that God gave them in His Word, the Bible? *No. They told people to keep a lot of other rules, too.*
3. Did Jesus tell people to keep all those extra rules the other teachers gave to the people? *No, He did not. He taught them that those extra rules were not God's laws at all.*
4. What did Jesus say was the first and greatest law? *To love God most of all.*
5. What did Jesus say was the second most important law of God that we should all obey? *To love others in the same loving way as we want others to treat us.*
6. What two laws did Jesus say sum up all of the other laws that God has given us? *To love God most of all, and love others in the same loving way as we want others to treat us.*
7. Who can help us to love God and others? *God can. He can help us turn away from our sins and trust in Jesus as our Savior. He can send the Holy Spirit to live in our hearts and help us to love Him and others as He wants us to.*

### Let's Pray!

- A** We praise You, God, for being the Giver of Your perfectly good laws that tell us how to love You and others.
- C** God, many times, we do not obey Your good laws. Many times, we do not love You or others as Your laws tell us to. We need a Savior!
- T** Thank You, God, for giving us Your good laws that show us how to love You and others. Thank You for sending Your Holy Spirit to live in our hearts when we trust in Jesus as our Savior. He helps us to obey Your good and loving laws.
- S** God, work in our hearts. Help us to turn away from our sins and trust in Jesus as our Savior. Send Your Holy Spirit to live inside our hearts and help us to love You and others as You want us to. In Jesus' name we pray, Amen.

### Let's Praise God Right Now!

#### Big Question 7 Hymn: Holy Bible, Book Divine *from Deep Down Detectives ESV Songs 7, track 17*

##### Verse 1

Holy Bible, book divine,  
Precious treasure, you are mine,  
You're the only Book divine,  
Precious treasure, you are mine.

##### Verse 2

Mine, to learn God's holy ways,  
How He'd have us live each day;  
Mine, to learn of Jesus Christ,  
Who died to give eternal life.

Words: John Burton, Sr., Constance Dever Music: Constance Dever

#### Big Question 7 Praise Song: The Best Book to Read Is the Bible *from Deep Down Detectives ESV Songs 7, track 18*

##### Verse 1

The best book to read is the Bible,  
The best book to read is the Bible,  
It alone is God's true Word,  
With the best news ever heard!  
Yes! The best book to read is the Bible.

##### Verse 2

The best book to read is the Bible,  
The best book to read is the Bible,  
If you read it ev'ry day,  
God will teach you His ways.  
Yes! The best book to read is the Bible.

Go to the *Deep Down Detectives Parent Resources for Unit 7* to get the Bible story and many more resources and songs for this unit at [praisefactory.org](http://praisefactory.org)

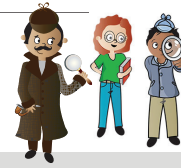
**Deep Down Devotions: Unit 7, Bible Truth 1 Story Concepts****P.1****The Case of the Do's and Don'ts***Matthew 5,6,22*

Dear Parents,

**Big Question #7 is:** "What Are God's Laws Like?" Your child is learning that "God's Laws Are Perfect...They Tell Us How to Love God and Others!"

Here's a copy of the Bible story they are learning along with the "Listening Assignment" for each lesson. These assignments provide a different teaching emphasis for each lesson, helping the children dig deeper into each Bible truth. They match up with your child's take home for each lesson. We hope that these resources help your family to dig down deeper into the truths of God's Word!" Happy digging!

•many more resources for this Big Question came be found online at [www.praisefactory.org](http://www.praisefactory.org)•

**Listening Assignments**

"Hey, Kids! Detective Dan, here. Listen carefully to the story and help me answer these questions:

**Detective Dan's Lesson #1 Listening Assignment:**

I need to know:

- 1. Who made up extra, little rules of do's and don'ts?**
- 2. What did Jesus think of those extra do's and don'ts? What did Jesus say God's real laws help people do?**

**Detective Dan's Lesson #2 Listening Assignment:****Our Bible Verse is Matthew 22:37-40:**

"You shall love the Lord your God with all your heart and with all your soul and with all your mind. This is the great and first commandment. And a second is like it: You shall love your neighbor as yourself. On these two commandments depend all the Law and the Prophets."

I need to know:

- 1. Which laws did Jesus tell people to obey?**
- 2. Who is the only person to obey God's laws perfectly? How did He share His perfect life with us?**

**Detective Dan's Lesson #3 Listening Assignment:**I found six clues, but two of them are **NOT** in the story.

They are: a pillow, a cup, two fish, a painter, a heart, and God's Ten, Big Laws.

*Hold each of them up for the children to see as you identify them.*

I need to know:

- 1. Which four belong in the story and which two don't?**
- 2. Who can help us keep God's laws and love others?**

**Read the assignment questions, THEN SAY,**

"Ok, Deep Down Detectives! Put on your best listening ears and see if you can hear the answers to Detective Dan's questions. When I finish telling the story, we will see if we can answer all the questions."

*Read the Bible Truth story, answer questions, present the gospel and lead in prayer.*

*Answers to questions; the gospel; and, ACTS prayer are included with the story text.*

**The Case of the Do's and Don'ts**

---

*Matthew 5,6,22**Story with lines separating paragraphs (text in bold, optional interaction cues in italics)*

**Rules! Rules! Rules! So many rules for God's people to keep! "Do this! Don't do that!" the teachers in Jesus' day (the Pharisees) taught the people. Of course, there were the Ten, Big Laws (the Ten Commandments) that God had given them through Moses. But there were so many more rules than that. Can you guess how many laws the Pharisees counted in God's Word for everyone to obey? Twenty? Fifty? Surely, not a hundred!**

*What do you think?*

**It was more than any of those guesses! It was 613! There were 248 DO laws and 365 DON'T laws.**

**But soon those 613 laws turned into even more, as the teachers made up extra ways they wanted God's people to live them out. They made up extra "DO's" like: "DO say a special prayer as you wash your hands when you wake up in the morning, or you won't please God." And extra DON'T's" like: "DON'T use the same spoon to stir milk and cook meat, or you won't please God." What a lot of rules! Oh, how they weighed down the people! Who could keep all these rules!**

**But then, Jesus came. He wasn't like any other teacher. He healed sick people without using any medicine! He brought dead people back to life again! He even forgave people's sins! Jesus simply spoke and God's power did these wonderful things through Him.**

**Jesus did other amazing things, too, like when He made the strong winds and the big waves of a huge storm at sea suddenly STOP and be calm at His command. And, when He fed a huge, hungry crowd of people with just two fish and five loaves of bread. Wow!**

**The news about Jesus spread quickly. Soon, many people were coming to Jesus. They came to have Him heal their sick family and friends. They came to see Him do amazing things. And, they came to hear what He had to say about God and His laws. Would Jesus be just like all the other teachers? Would He tell them to keep all those Do's and Don'ts? Would He give them lots of extra rules like the Pharisees did?**

*What do you think?*

**Soon, Jesus answered all of their questions.**

**One day, Jesus and a huge crowd of people climbed up, up, up a grassy mountain above the Sea of Galilee. When they reached the top, Jesus sat down and began to teach them about God's laws.**

**"God's laws are very important. They will last until the end of time. I have not come to get rid of even one of God's good laws," Jesus told the people. "Your teachers, the Pharisees, try to please God by adding lots of extra, little rules to God's good laws. They think all this rule-keeping will make them right with God, but it's not enough. You need something more than all their extra, little rules to please God. You will need a better righteousness than theirs, if you want to be God's people," Jesus told them.**

**Oh, no! This didn't sound good at all! The Pharisees worked so hard to keep all 613 laws in the Bible! And, they made up all those hundreds of extra, little rules, to try to please God, too. How could ANYONE be better than the Pharisees? Was Jesus going to give them even MORE rules to live by? It sure sounded that way.**

*What do you think?*



**Bible Story for Big Question 7, Bible Truth 3** use with all THREE lessons**P.3***Story with lines separating paragraphs (text in bold, optional interaction cues in italics)*

**No, Jesus was not. "Your teachers are wrong about their extra, little rules. They just weigh down people. They don't help anyone live as God wants them to live," Jesus said. "I have come to fulfill God's law. I will teach you how to really live out God's laws to please Him," He told the crowds.**

**"The Do's and Don'ts in God's Word are about how we show love to God and others. These laws start in the heart with love, and they tell us how God wants us to live out that love with our whole lives," Jesus explained.**

**"Some people LOOK like they obey God's laws, but really, they are still breaking them," Jesus told the people. "They do the right thing on the outside, but in their hearts, they are angry or jealous or hateful. God doesn't just look on the outside. He sees inside every heart. He knows the sin that is hiding there. He knows when you are angry or jealous or hateful. What goes on inside your heart breaks God's laws, too," Jesus explained.**

**The people listened to Jesus and were amazed! Jesus wasn't at all like the other teachers they had heard before. He didn't just give them lots of extra, little rules. He helped them see that God's laws show them how to truly love God and others. As Jesus later said: "Love the LORD with all your heart, your mind, and your strength. Love others --even your enemies-- as much as you love yourself. Do to them only what you want them to do to you. If you do love the LORD and love others like this, you will be obeying all of God's laws, because that's what God's laws are really all about."**

**How about that! All of those 10 Commandments, and even all of those 613 laws, really added up to only two: love the LORD and love others. Amazing!**

**I wonder what people were thinking as they climbed down the mountain at the end of the day. Jesus had given them less rules to follow, but they were much harder than all those 613 Do's and Don'ts in God's Word, and all those extra, little rules of the Pharisees. Anyone could remember to wash their hands when they woke up in the morning or to use a different spoon when they stirred the milk and cooked the meat. But loving God and others from the heart... that was so hard! How could they ever keep their hearts from being angry or jealous or hateful towards others? How could they really love God most of all? Could they ever really keep God's laws? Could they ever please God and really love God's people, if this was how they must live? There seemed to be no hope.**

*What do you think?*

**Well, there WAS no hope, if they had to obey God's good laws of love on their own. But praise God, they did NOT! That's why God sent Jesus! Not just to TELL the people what it really means to live out God's laws. But to DO it, HIMSELF! Yes, Jesus lived out God's laws perfectly every day He lived here on earth. He always loved God most of all. He always loved people. In everything He thought, and said, and did, Jesus fulfilled God's law completely. He pleased God with His whole life. Jesus could do this because He was the perfect Son of God. He truly loved God, His Father, and He had come to be our Savior.**

**And what did the Pharisees think about what Jesus taught? They did NOT like it!**

**They did not like that Jesus said He was God's Son. They did not like what Jesus said about them and all of their extra, little rules. And so, the Pharisees and other enemies worked together to get rid of Jesus. They nailed Him to a cross to suffer and die, and to get rid of Him, once and for all.**

**But God was up to good, even in the bad plans of Jesus' enemies. For on that cross, Jesus offered up His perfect life as the full payment for the sins of all who would ever turn away from their sins and trust in Him as their Savior. He took their punishment and gave them His perfect life. Now, they could please God. Not with their own lives, but with His!**

*Story with lines separating paragraphs (text in bold, optional interaction cues in italics)*

**Jesus died and was buried in a cave-grave that sad day, but did He stay there?**

*What do you think?*

**No, He did not! On the third day, He rose from the dead. Jesus had really beaten sin and death for God's people!**

**After Jesus rose from the dead, He appeared to His followers and taught them more about God's good plans. Best of all, He told them about God's special gift to help them live out God's law from their hearts. Do you know what that special gift was?**

*Can you guess?*

**It was the Holy Spirit!**

**"I am going back home to heaven, but I will send you the Holy Spirit to live in your hearts," Jesus told His followers. "He will fill your hearts with love. He will help you love God most of all. He will help you love others, too. And He will stay with you your whole lives until the day you come home to live with Me forever," Jesus promised them.**

**And sure enough, not long after Jesus went up to heaven, He did send the Holy Spirit to live in the hearts of God's people! How they praised God! How happy they were!**

**God had been so good to them through Jesus! Jesus had lived a perfect life of love and given it to them, so they could be God's people. He had sent the Holy Spirit to live inside their hearts for the rest of their lives. He would change their hearts and help them to obey God's laws and love God and others.**

**And, how they looked forward to the day when they would go to live with Him forever! Then, God would make all things new, even their hearts. Then, they would love God and each other perfectly. And at last, God's laws would be perfectly fulfilled, even in them! We can become God's people, too, when we turn away from our sins and trust in Jesus as our Savior. Ask Him to help you!**

**Cracking the Case:** (story wrap-up for Listening Assignments)

It's time to see how we did with our Listening Assignment.

**Detective Dan's Lesson 1 Listening Assignment:****1. Who made up extra, little rules of do's and don'ts?**

The Pharisees.

**2. What did Jesus think of those extra do's and don'ts? What did Jesus say God's real laws help people to do?** Jesus knew those do's and don'ts weren't what pleased God. Jesus said God's real laws help people love God most of all and love others.

**For You and Me:**

None of us can ever obey God's laws well enough to please God. Only keeping God's laws perfectly can do that, and we are all law-breakers! Our only hope is by turning away from our sins and trusting in Jesus as our Savior. He is the only way we can please God. Ask Him to help you. He loves to answer this prayer!

**Detective Dan's Lesson 2 Listening Assignment:****Our Bible Verse is Matthew 22:37-40:**

"You shall love the Lord your God with all your heart and with all your soul and with all your mind. This is the great and first commandment. And a second is like it: You shall love your neighbor as yourself. On these two commandments depend all the Law and the Prophets."

**I need to find out:**

**1. Which laws did Jesus tell people to obey?** God's laws.

**2. Who is the only person to obey God's laws perfectly? How did He share His perfect life with us?**

Jesus. He gave it up on the cross as the full payment for the sins of God's people when He suffered and died on the cross.

**For You and Me**

How amazing that Jesus kept God's laws perfectly! It's even more amazing that He offers to share His perfect life with us, that we might be saved! This is His promise to all who turn away from their sins and trust in Him as their Savior. Ask Him to help you do this! He loves to answer this prayer!

**Detective Dan's Lesson 3 Listening Assignment:**

Our six clues were: a pillow, a cup, two fish, a painter, a heart, and God's Ten, Big Laws.

**1. Which four belong in our story?**

The cup, the fish, the heart and God's Ten, Big Laws.

**2. Who can help us keep God's laws and love others?**

God's Holy Spirit, living in our hearts.

**For You and Me:**

Can God help us keep His laws and love others, too? Yes, He can! He will send His Holy Spirit to live inside all who turn away from their sins and trust in Jesus as their Savior. What a wonderful helper He is to have! He can come to live inside you and help you, too!

**The Gospel** (story wrap-up if NOT using Listening Assignments)**Our Bible Truth is:****What Are God's Laws Like?****God's Laws Are Perfect...****They Tell Us How to Love God and Others!**

God's laws tell us how to love God and others. But the sad news is that we all choose to not love God and others. We choose to disobey God and not love Him or others. We all deserve His punishment for our sins! God would have been perfectly fair to give us all the punishment we deserve for breaking His laws. He is holy and good. But God is so rich in mercy. He chose to give us something better than we deserve. He sent His Son Jesus to live a perfect life. Yes! Jesus kept every, single one of God's laws! And on the cross, He suffered and died, giving His perfect life as the full payment for the sins of all who turn away from their sins and trust in Him as their Savior. On the third day, Jesus rose from the dead. He had really beaten sin and death! Because of Jesus, all who trust in Him as their Savior get to enjoy wonderful, special closeness with God as His special people, even now. And one day, they will go to live with Him forever. We can be God's people when we turn from our sins and trust in Jesus. Ask Him to help you! He loves to do this!

*Close in prayer.*

**Closing ACTS Prayer**

- A** We praise You, God, for being the Giver of Your perfectly good laws that tell us how to love You and others.
- C** God, many times, we do not obey Your good laws. Many times, we do not love You or others as Your laws tell us to. We need a Savior!
- T** Thank You, God, for giving us Your good laws that show us how to love You and others. Thank You for sending Your Holy Spirit to live in our hearts when we trust in Jesus as our Savior. He helps us to obey Your good and loving laws.
- S** God, work in our hearts. Help us to turn away from our sins and trust in Jesus as our Savior. Send Your Holy Spirit to live inside our hearts and help us to love You and others as You want us to.

In Jesus' name we pray, Amen.

**Big Question 7, Bible Truth 3 Overview: Key Concepts****P.7****Unit 7: God, the Just and Merciful**

**Unit Big Question (and Answer):** What Are God's Laws Like? God's Laws Are Perfect!

**Unit Bible Verse:** "The law of the LORD is perfect." Psalm 19:7

**Bible Truth 3 Concept: God's Laws Are Perfect... They Tell Us How to Love God and Others!**

The LORD is the one, true God. He deserves our love. He made us to love Him more than anything else. Loving God is the most delightful thing we can do. God gave us His laws so we can know how to love Him. When we obey His laws, we are living out our love for Him.

God made us not just to love Him, but also to love each other. He gave His laws so we can know how to love each other. He tells us to treat others in the same loving way we want others to treat us. When we obey God's laws, we are living out God's love for others. And, we are showing them a little bit of what God is like, that they might seek to know and love Him, too.

Obeying God's laws is not just the right way to live. It is also the happiest way to live with God and with other people. God can help us obey His laws and live in love when we turn away from our sins and trust in Jesus as our Savior. He gives us a new heart filled with His Holy Spirit and helps us to live in love as He wants us to.

**Bible Truth 3 Bible Verse: Matthew 22:37-40, ESV**

"You shall love the Lord your God with all your heart and with all your soul and with all your mind. This is the great and first commandment. And a second is like it: You shall love your neighbor as yourself. On these two commandments depend all the Law and the Prophets."

**Learn a Little:** "Love the Lord your God with all your heart, soul and mind... Love your neighbor as yourself."

**Meaning**

God has given us many laws in the Bible. It's good to know them all. But Jesus tells us in these verses that the purpose behind all of God's laws is to love God most of all, and to love others as we love ourselves. When we live out all His good laws, we are loving God and love others as He wants us to.

**Bible Truth 3 ACTS Prayer**

- A** We praise You, God, for being the Giver of Your perfectly good laws that tell us how to love You and others.
- C** God, many times, we do not obey Your good laws. Many times, we do not love You or others as Your laws tell us to. We need a Savior!
- T** Thank You, God, for giving us Your good laws that show us how to love You and others. Thank You for sending Your Holy Spirit to live in our hearts when we trust in Jesus as our Savior. He helps us to obey Your good and loving laws.
- S** God, work in our hearts. Help us to turn away from our sins and trust in Jesus as our Savior. Send Your Holy Spirit to live inside our hearts and help us to love You and others as You want us to.  
In Jesus' name we pray, Amen.

**Bible Truth 3 Story****The Case of the Do's and Don'ts**

*Matthew 5,6,22*

---

**Songs Used in Bible Truth 3**

Big Q & A 7 Song

Big Question 7 Song: What Are God's Laws Like?

Big Question 7 Bible Verse Song: The Law of the Lord Psalm 19:7, ESV

*Extra Big Question 7 Bible Verse Song: The Law of the Lord Is Perfect Psalm 19:7, ESV (full version)*

Big Question 7 Hymn: Holy Bible, Book Divine

Big Question 7 Praise Song: The Best Book to Read Is the Bible

Bible Truth 3 Bible Verse Song: Love the Lord Matthew 22:37-40, ESV

listen to or download songs for free at <https://praisefactory.org>: Deep Down Detectives Music page