

CAN YOU GUESS BIBLE TRUTH 2:
What Are God's Laws Like?
God's Laws Are Perfect...

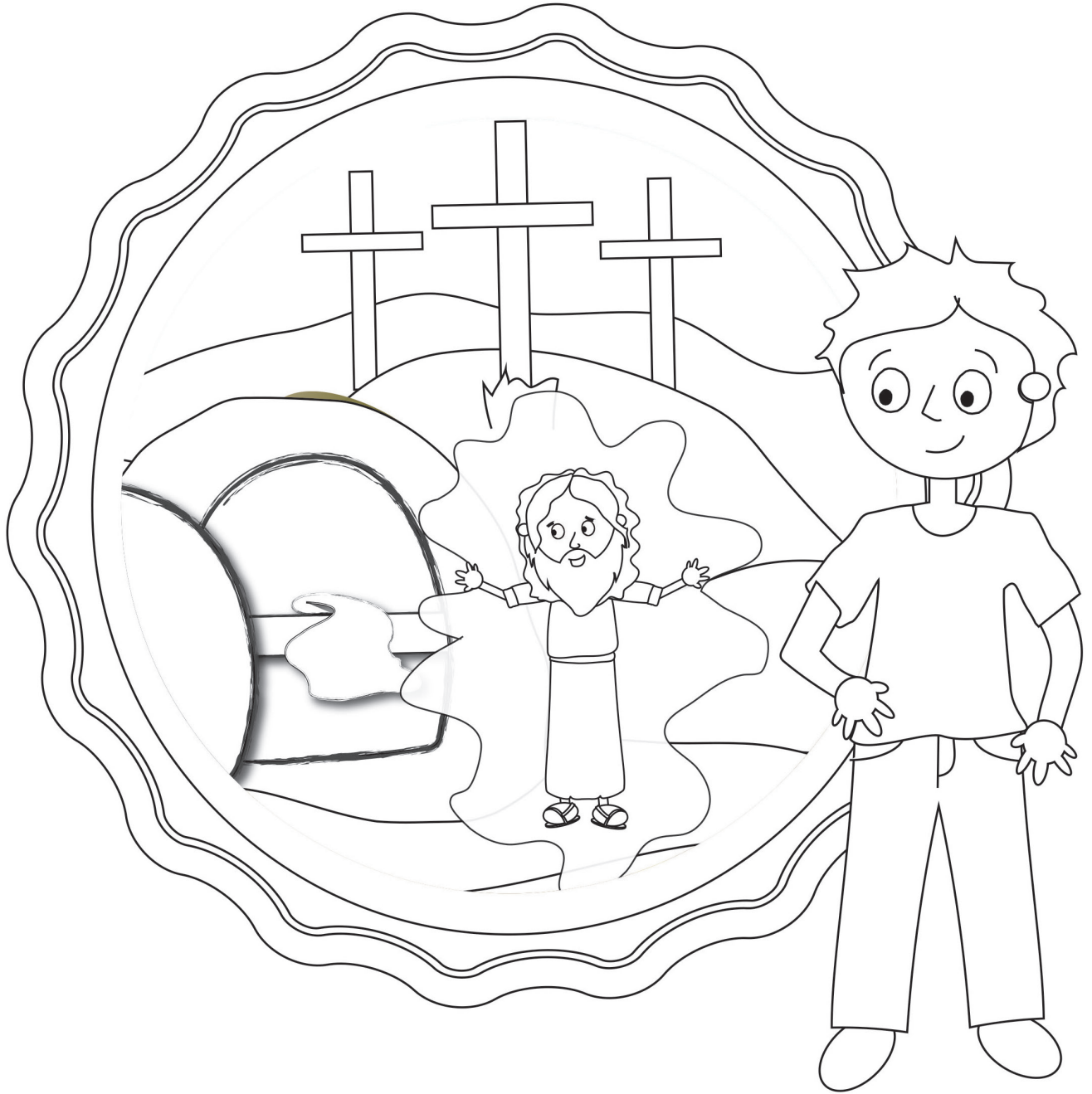

They Show Us that We Need God to _____ Us!

HINT: "What did Jesus do for God's people when He died on the cross?"

It starts with an "s" and it rhymes with "brave."

Deep Down Detective Devotion: Unit 7, Bible Truth 2, Lesson 1



Big Question 7: What Are God's Laws Like?

Answer: God's Laws Are Perfect... They Show Us that We Need God to Save Us!

Bible Truth 2 Meaning

God made us and He is in charge of us. He expects us to obey His laws all the time. But sadly, we do not. We all are sinners with sinful, selfish hearts. We disobey God's laws. We deserve His punishment for our sins. How we have rebelled against Him and His good ways! But God is so kind and merciful! He treats us better than we deserve. He sent Jesus to take the punishment for the sins of all who trust in Him as their Savior. God forgives their sins and gives them special closeness with Him in their hearts. And when they die, they will go to live with Him forever in a perfect world where there will never again be any sin. Yes! They will never again sin against Him or break His good laws. They will always love Him and others as He wants them to. How wonderful that will be! Jesus can be our Savior, too, when we turn away from our sins and trust in Him as our Savior.

How do I know this is true? The Bible tells me so!

"No one will be declared righteous... by observing the law; But now a righteousness from God, apart from law... comes through faith in Jesus Christ to all who believe... For all have sinned and fall short of the glory of God." --Romans 3:20,21,22,23

Some Questions for You

1. Who made us and is in charge of us? *God.*
2. When does God expect us to obey His laws? *All the time!*
3. We don't obey God's laws all the time. Why not? *Because we are sinners with sinful, selfish hearts.*
4. What do we all deserve for disobeying God's laws? *His punishment.*
5. Who did God send to save us from our sins? *God sent Jesus to die on the cross and take the punishment that we deserve from God for our sins.*
6. What must we do for God to forgive us and save us? *Turn away from our sins and trust in Jesus as our Savior. This is how we become God's dearly-loved people.*
7. What does God give us to enjoy when we become His people? *Special closeness with Him now; and when they die, perfectly wonderful life with Him forever!*

Let's Pray!

- A** We praise You, God, for being the Giver of Your perfectly good laws.
- C** God, instead of obeying Your good laws, we have all chosen to break them. Sometimes, we don't obey our parents. Sometimes, we lie. Sometimes, we want things that belong to others. We do not always love you most of all. These are only some of the ways we break Your good laws. Oh, how we need a Savior!
- T** Thank You, God, for giving us Your good laws, so we know how to love and obey You. And thank You for sending Jesus to perfectly live out Your laws and to give His life as the perfect payment for the sins of Your people. Thank You that He can be our Savior when we turn away from our sins and trust in Him.
- S** God, work in our hearts. Help us to turn away from disobeying You and trust in Jesus as our own Savior. Help us to know You and love You with the spirit You put inside us. Help us to learn Your good laws and obey them.
In Jesus' name we pray, Amen.

Let's Sing about What We're Learning!

Big Q & A 7 Song from *Deep Down Detectives NIV Songs 7, track 12*
(adapted version of "The Farmer in the Dell")

What are God's laws like?
What are God's laws like?
What are God's laws like?
God's laws are perfect!

Big Question 7 Action Rhyme Song from *Deep Down Detectives NIV Songs 7, track 13*

Refrain:
What are God's laws like?
What are they like?
God's laws are perfect!
God's laws are perfect!
What are God's laws like?
What are they like?
God's laws are like Him,
They are good and just.

Verse 1
God is our Creator,
He's in charge of the whole world.
He gave us laws to live by,
They are written in His Word.
Refrain

Verse 2
God's laws are the best way,
For us all to live,
God calls us to obey them,
To reflect His righteousness. *Refrain*

10 Commandments:

1. Love Me most of all
2. Don't worship fake gods. Worship only Me
3. Love me by how you talk about Me and how you live
4. Keep a special rest and worship Me
5. Love and obey your mother and father
6. Don't steal
7. Keep your promise to love only your husband/wife
8. Don't take other people's things
9. Don't lie
10. Be happy with what I give you. Don't be greedy for what others have

Jesus' Perfect Life Forgiven

SIN

SIN

"No one will be declared righteous... by observing the law; But now a righteousness from God, apart from law... comes through faith in Jesus Christ to all who believe... For all have sinned and fall short of the glory of God." --Romans 3:20-23

Deep Down Detective Devotion: Unit 7, Bible Truth 2, Lesson 2



Big Question 7: What Are God's Laws Like?

Answer: God's Laws Are Perfect... They Show Us that We Need God to Save Us!

How do I know this is true? The Bible tells me so:

"No one will be declared righteous... by observing the law; But now a righteousness from God, apart from law... comes through faith in Jesus Christ to all who believe... For all have sinned and fall short of the glory of God." --Romans 3:20,21,22,23

Learn a Little: "Righteousness... from God, apart from law... comes through faith in Jesus Christ to all who believe."

Meaning:

"Righteous" is a big word that means that you are right with God. The only way we can be right with God ON OUR OWN is by obeying God's laws perfectly. But, uh oh! This Bible verse tells us that we are all sinners who break God's laws. That means we can't EVER be right with God by obeying God's laws.

But God has made a way for us to be right with Him—through His Son, Jesus. Jesus came and lived a perfect life. He kept all of God's good laws perfectly. He was righteous! And this Bible verse tells us that for all who trust in Jesus as their Savior, Jesus takes away their sins and gives His righteousness to them. That means God treats them as if they had never broken God's laws or sinned-- just like Jesus! Wow! Isn't that amazing! Isn't Jesus a wonderful Savior! He can be our wonderful Savior, too, when we turn away from our sins and trust in Him as our Savior.

Some Questions for You

1. What does righteous mean? *God thinks everything you do is just right, as God's laws tell us to.*
2. Do any of us keep God's laws perfectly? *Are any of us righteous on our own? None of us keep God's laws perfectly. None of us are righteous by our own works (by how we obey God's laws).*
3. How did Jesus live when He came to earth? *He always kept God's laws. He was truly righteous.*
4. What did Jesus choose to give to all who trust in Him as His Savior? *His own, perfect righteous.*
5. How can Jesus become our Savior? *When we turn from our sins and trust in Him as our Savior.*
6. Who does God see as righteous because of Jesus? *All of God's people--all who turn from their sins and trust in Him as their Savior.*

Let's Pray!

- A** We praise You, God, for being the Giver of Your perfectly good laws.
- C** God, instead of obeying Your good laws, we have all chosen to break them. Sometimes, we don't obey our parents. Sometimes, we lie. Sometimes, we want things that belong to others. We do not always love you most of all. These are only some of the ways we break Your good laws. Oh, how we need a Savior!
- T** Thank You, God, for giving us Your good laws, so we know how to love and obey You. And thank You for sending Jesus to perfectly live out Your laws and to give His life as the perfect payment for the sins of Your people. Thank You that He can be our Savior when we turn away from our sins and trust in Him.
- S** God, work in our hearts. Help us to turn away from disobeying You and trust in Jesus as our own Savior. Help us to know You and love You with the spirit You put inside us. Help us to learn Your good laws and obey them.
In Jesus' name we pray, Amen.

Let's Sing Our Bible Verse!

Observing the Law: Romans 3:20-23

from *Deep Down Detectives NIV Songs 7, track 19*

Observing the law,	Apart from the law,
Observing the law,	Apart from the law,
No one will be declared righteous,	Now a righteousness comes from God,
By observing the law. <i>Why?</i>	Apart from the law. <i>How?</i>
For we all have sinned,	Comes through faith in Christ,
Fall short of the glory of God. <i>Oh, no!</i>	To all who believe. <i>Thank you, God!</i>
	Romans Three, twenty through twenty-three.

Go to the *Deep Down Detectives Parent Resources for Unit 7* to get the Bible story and many more resources and songs for this unit at praisefactory.org

DDD BQ7 BT2 L2 Coloring Sheet/Take Home pg2

Which four of these clues belong in our story? Which two do not? Put an X in the boxes of the four that belong.

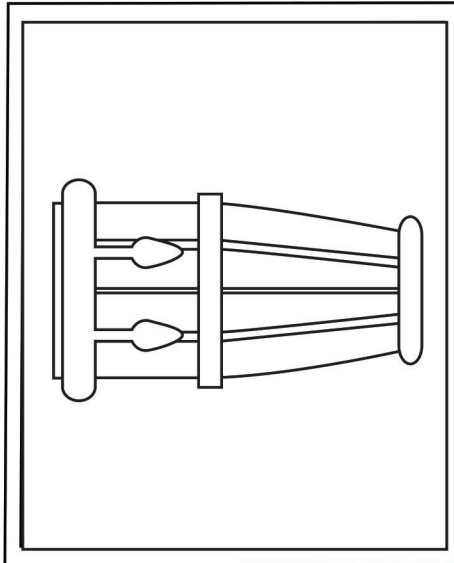

A Drum

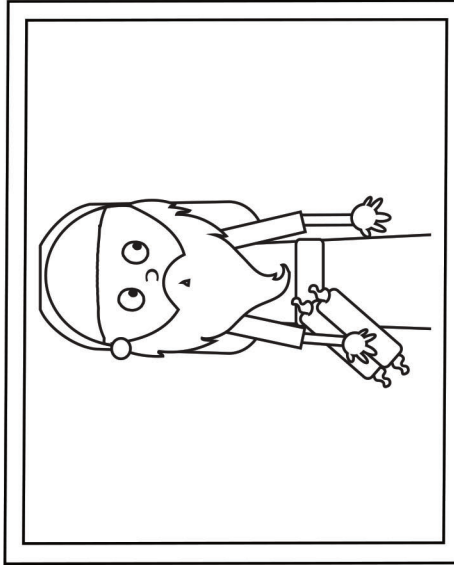

A Pharisee

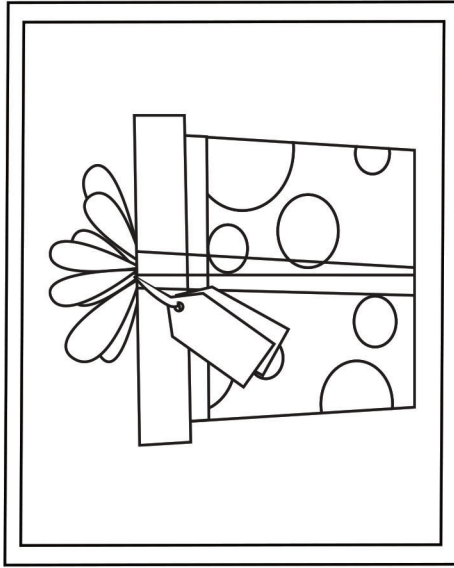

A Golden Box

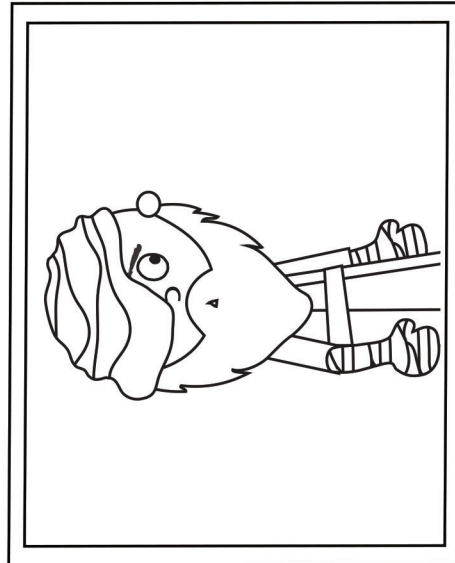

A Sick Man

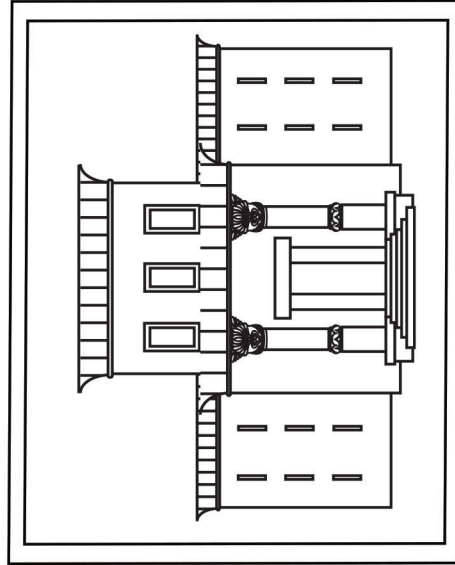

The Temple

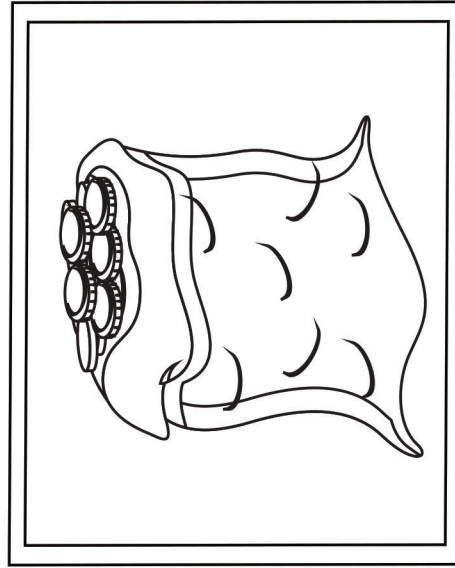

A Bag of Money

The bunny, The Pharisee, sick man, Temple and bag of money belong. The drum and box do not.

Deep Down Detective Devotion: Unit 7, Bible Truth 2, Lesson 3



Big Question 7: What Are God's Laws Like?

Answer: God's Laws Are Perfect... They Show Us that We Need God to Save Us!

Bible Truth 2 Meaning

God made us and He is in charge of us. He expects us to obey His laws all the time. But sadly, we do not. We all are sinners with sinful, selfish hearts. We disobey God's laws. We deserve His punishment for our sins. How we have rebelled against Him and His good ways! But God is so kind and merciful! He treats us better than we deserve. He sent Jesus to take the punishment for the sins of all who trust in Him as their Savior. God forgives their sins and gives them special closeness with Him in their hearts. And when they die, they will go to live with Him forever in a perfect world where there will never again be any sin. Yes! They will never again sin against Him or break His good laws. They will always love Him and others as He wants them to. How wonderful that will be! Jesus can be our Savior, too, when we turn away from our sins and trust in Him as our Savior.

How do I know this is true? The Bible tells me so:

"No one will be declared righteous... by observing the law; But now a righteousness from God, apart from law... comes through faith in Jesus Christ to all who believe... For all have sinned and fall short of the glory of God." --Romans 3:20,21,22,23

Some Questions for You

1. What did Jesus teach the Pharisees who tried so hard to be good? Did they need God to save them? *Yes, they did! We all need God to save us, no matter how hard we try to be good.*
2. Where did all the extra rules of the Pharisees come from? From God in the Bible? *No, they did not! They were made up by other teachers. They were lots of extra rules that God didn't tell His people to obey.*
3. Why weren't the Pharisees eager to hear about Jesus like the other people? *They thought they were so good that they didn't need to be saved. They didn't like that Jesus did tell people to keep all those extra rules.*
4. Did the Pharisee or the tax collector go home with everything right with God? *The tax collector did, even though he had done many bad, bad things. The Pharisee did not.*
5. Why did God forgive the tax collector? *Because he humbly asked God to forgive him.*
6. Why did the Pharisee go home with things not right between him and God? *Because he was proud. He didn't tell God that he had disobeyed Him. He didn't ask God to forgive him. He thought he was too good to need God's forgiveness.*
7. How does God want us to be like the tax collector? *By humbly telling God about the bad things we've done and ask His forgiveness through Jesus.*

Let's Pray!

- A** We praise You, God, for being the Giver of Your perfectly good laws.
- C** God, instead of obeying Your good laws, we have all chosen to break them. Sometimes, we don't obey our parents. Sometimes, we lie. Sometimes, we want things that belong to others. We do not always love you most of all. These are only some of the ways we break Your good laws. Oh, how we need a Savior!
- T** Thank You, God, for giving us Your good laws, so we know how to love and obey You. And thank You for sending Jesus to perfectly live out Your laws and to give His life as the perfect payment for the sins of Your people. Thank You that He can be our Savior when we turn away from our sins and trust in Him.
- S** God, work in our hearts. Help us to turn away from disobeying You and trust in Jesus as our own Savior. Help us to know You and love You with the spirit You put inside us. Help us to learn Your good laws and obey them.
In Jesus' name we pray, Amen.

Let's Praise God Right Now!

Big Question 7 Hymn: Holy Bible, Book Divine *from Deep Down Detectives NIV Songs 7, track 15*

Verse 1

Holy Bible, book divine,
Precious treasure, you are mine,
You're the only Book divine,
Precious treasure, you are mine.

Verse 2

Mine, to learn God's holy ways,
How He'd have us live each day;
Mine, to learn of Jesus Christ,
Who died to give eternal life.

Big Question 7 Praise Song: The Best Book to Read Is the Bible *from Deep Down Detectives NIV Songs 7, track 16*

Verse 1

The best book to read is the Bible,
The best book to read is the Bible,
It alone is God's true Word,
With the best news ever heard!
Yes! The best book to read is the Bible.

Verse 2

The best book to read is the Bible,
The best book to read is the Bible,
If you read it ev'ry day,
God will teach you His ways.
Yes! The best book to read is the Bible.

**The Case of the Rotten Innards***Luke 18:9-14*

Dear Parents,

Big Question #7 is: "What Are God's Laws Like?" Your child is learning that "God's Laws Are Perfect... They Show Us that We Need God to Save Us."

Here's a copy of the Bible story they are learning along with the "Listening Assignment" for each lesson. These assignments provide a different teaching emphasis for each lesson, helping the children dig deeper into each Bible truth. They match up with your child's take home for each lesson. We hope that these resources help your family to dig down deeper into the truths of God's Word!" Happy digging!

•many more resources for this Big Question came be found online at www.praisefactory.org•

Listening Assignments

"Hey, Kids! Detective Dan, here. Listen carefully to the story and help me answer these questions:

Detective Dan's Lesson #1 Listening Assignment:

"Innards" is a funny word that means a person's insides. And in this case, it means a person's heart, meant to love and obey God.

I need to know:

- 1. Who had a rotten heart and knew it? Who had a rotten heart and DIDN'T know it?**
- 2. What did Jesus want them all to do?**

Detective Dan's Lesson #2 Listening Assignment:**Our Bible Verse is Romans 3:20,21,22,23**

"No one will be declared righteous... by observing the law; But now a righteousness from God, apart from law... comes through faith in Jesus Christ to all who believe... For all have sinned and fall short of the glory of God."

I need to know:

- 1. Who thought they were justified (good) in God's sight? Why weren't they?**
- 2. What did Jesus want these people to do?**

Detective Dan's Lesson #3 Listening Assignment:I found six clues, but two of them are **NOT** in the story.

They are: a drum, a Pharisee, a golden box, a sick man, the Temple, and a bag of money..

Hold each of them up for the children to see as you identify them.

I need to know:

- 1. Which four belong in the story and which two don't?**
- 2. What did the bad, bad, bad man pray that pleased God? What did God do for this man?**

Read the assignment questions, THEN SAY,

"Ok, Deep Down Detectives! Put on your best listening ears and see if you can hear the answers to Detective Dan's questions. When I finish telling the story, we will see if we can answer all the questions."

Read the Bible Truth story, answer questions, present the gospel and lead in prayer.

Answers to questions; the gospel; and, ACTS prayer are included with the story text.

The Case of the Rotten Innards *Luke 18:9-14**Story with lines separating paragraphs (text in bold, optional interaction cues in italics)*

Many sick people came to see Jesus. They came with their limping legs, their blind eyes, their skin with sores, and their bleeding that wouldn't stop. Some of them were about to die. They all came to Jesus, and what do you think Jesus did?

Can you guess?

Jesus healed them with God's power! No doctor or medicine needed! "Who has ever healed sick people the way Jesus does?" they exclaimed.

People who wanted to hear about God came to Jesus, too. They crowded around Jesus, listening to everything He had to say. Jesus told them about God and His Kingdom. He told them how God wanted them to live. They listened to Jesus and were amazed at what He had to say. "Who has ever told us about God the way Jesus does?" they exclaimed.

Even people who had done very sinful things came to Jesus. Men and women who had disobeyed God's Ten Commandments in so many ways: people who had stolen money; people who had not loved their husbands or wives; people who had hurt other people; people who had worshipped other gods, and so many more. They all came to Jesus, and what do you think happened?

What do you think?

Jesus gave them God's forgiveness, when they turned away from their sins and trusted in Him. "Who has ever forgiven sins the way Jesus does?" they exclaimed.

Sick people, sinful people, people eager to learn about God, all came to Jesus, and He satisfied them. How wonderful, how amazing was Jesus!

But there was another kind of people who came to Jesus, too. These people were different from all the rest. They weren't sick. They weren't eager to learn about God from Jesus. And most of all, they didn't even think they were sinners who needed God's forgiveness. They were the important Bible teachers back in Jesus' day. They had a special name for themselves. Do you know what it was?

*Can you remember?***They were called the Pharisees.**

The Pharisees were smart students, and they studied hard. Not only did they learn and try to obey God's Ten Commandments, but they learned and tried to obey the hundreds of God's other laws, too. They spent day after day, week after week, year after year, learning them all by heart! Wow!

But obeying God's laws wasn't enough for the Pharisees. They wanted to be extra careful to please God, so they added a lot of extra, little rules for everyone to obey. Rules that God didn't give His people. They added extra rules about washing your hands just right. (Not to get rid of dirt or germs that might make you sick, as we do, but because they thought these specially cleaned hands were how you pleased God.) Those hand-washing rules were just the beginning of what they added to God's laws. There were rules about food to eat or not eat, about giving extra gifts to God, and about what work you could NOT do on the Sabbath Day of Rest (such as not looking in a mirror because you might be tempted to pluck out a gray hair from your head), and lots of other rules. The Pharisees tried very hard to obey all their extra, little rules. They wanted the people to obey them, too. They thought those extra, little rules helped everyone keep God's big laws better. They thought those extra rules pleased God and made them good people.

Story with lines separating paragraphs (text in bold, optional interaction cues in italics)

And most of all, the Pharisees thought God might send the Messiah, the Savior, sooner if everyone was very good, and kept all the little, bitty rules as well as God's big laws. Oh, how they wanted the Messiah to come!

But those Pharisees were wrong about so many things! They didn't realize that the Messiah, the Savior, HAD come already. He was right there, living among them, teaching them about God, and doing amazing things by God's power. Can you tell me who God's Savior was?

Can you tell me?

It was Jesus!

And the Pharisees were wrong about something else, too. Instead of becoming good, good, good people when they kept all of these extra little, bitty, rules, these Pharisees became proud, proud, proud people! "We are better than everyone else because we do such a good job obeying all these extra, little, bitty rules," many of them thought. "We're so good that we don't need God's forgiveness, as other people do. God is pleased with us just the way we are!" they believed.

Do you think these Pharisees were right? Did keeping all of these extra, little, bitty rules mean they didn't need God's forgiveness?

How very wrong those Pharisees were! All those extra, little, bitty rules they made up didn't please God. Why, even trying very hard to obey all of God's big laws isn't enough to please God! There is only ONE WAY to please God by obeying His laws. Do you know what it is?

It is being PERFECT. That right! It's obeying God's laws ALL THE TIME! Never disobeying ...EVER! Never saying anything wrong or doing anything wrong. Never thinking anything wrong or BEING anything wrong. Do you think that sounds like something those Pharisees could do?

What do you think?

No, the Pharisees could not be this good. They had "rotten innards" --sinful hearts-- just like everyone else. They would never be able to please God by trying to be good.

And guess what? Neither can we. Why? Because every one of us has a sinful heart, too. Every one of us has broken God's laws. We all need God's forgiveness for our sins. That is the only way we can know and please God. That's the only way we can live with God as His people.

But these poor, proud Pharisees would just not see this. They were SURE that they were already good enough to please God, and they were SURE that all those other people who came to Jesus were not. So, what did Jesus do with these proud men who thought they were so good?

What do you think He did?

Jesus loved them, that's what He did. Jesus wanted to help them, just like He wanted to help everyone else who came to Him. So, Jesus told them a story to help them see that they needed God to save them and forgive them, just like everyone else did. Maybe then they would understand that they were sinners and would ask God for forgiveness.

Story with lines separating paragraphs (text in bold, optional interaction cues in italics)

And this is the story Jesus told them:

“One day, two men went to God’s Temple (the worship place) to pray. One man was a Pharisee. The other man was a tax collector;” Jesus said.

“The Pharisee thought of himself as a very good man who pleased God by obeying God’s laws and the teachers’ extra rules. So, he stretched his arms up high and looked up to heaven and proudly prayed, “God, thank You that I am different from other men, like that tax collector over there. I don’t do the bad things they do. I am good, good, good. I keep all your laws and all the extra rules of my teachers, too;” he prayed.

Can you believe that? That Pharisee didn’t praise GOD for being good! He only boasted to God about his OWN goodness! That Pharisee wasn’t really a good, good, good man at all, was he? No! He was really a proud, proud, proud man!

Then, Jesus went on with his story. He told about the other man. “The tax collector came to the Temple knowing he was a bad, bad, bad man. He knew he had “rotten innards” --a sinful heart. He knew the sin in his heart showed in how he lived. He had chosen to disobey God’s good laws. He had chosen to become rich by taking too much money from people.

And when this tax collector prayed to God, it wasn’t boldly and proudly like the Pharisee. No, this man KNEW he had done lots of bad things and he was sad about them. He was sad he had disobeyed God’s laws and treated others so badly. He KNEW he wasn’t right with God; and oh, how he wanted to be!

The tax collector was too ashamed of his sins to stretch up his arms or look up to heaven to pray. He looked down at his feet, beat his chest, and cried out to God, “God, have mercy on me! I am so bad. I have disobeyed Your laws. I have a sinful heart. Have mercy on me! Please, forgive my sins!”

Then Jesus told the Pharisees listening to Him: “The Pharisee went home feeling proud. He was so sure that his life pleased God, but he was wrong. God is not pleased with proud people who don’t see that they are sinners who need His forgiveness;” Jesus told them.

“But that tax collector, who knew he was a sinner, went home forgiven by God;” Jesus said. “God loves to forgive sinners --even very bad sinners-- who confess their sins to Him and humbly ask for His forgiveness;” Jesus told them.

What did the Pharisees think of Jesus’ story? Did they learn from it? Did they see that everyone has broken God’s laws, even people, like themselves, who tried really hard to be good? Did they, at last, see that no one can ever do enough good things to be proud before God? Did they see their own sins and ask God to forgive them?

What do you think?

The Bible doesn’t tell us what happened with those Pharisees that day. But, we DO know that later, some of these very important teachers --like Joseph of Arimathea and Nicodemus-- DID turn away from their sins and asked God to forgive them. They put their trust in Jesus as their Savior. And did you know that these two men were the very ones who put Jesus’ body in the cave-grave, after He had suffered and died on the cross?

How amazed and happy they both must have been when Jesus rose from the dead on the third day! Jesus really was the Messiah, the Savior, God had sent to save His people and forgive their sins! He had beaten sin and death for all who turn away from their sins and trust in Him as their Savior.

Cracking the Case: (story wrap-up for Listening Assignments)

It's time to see how we did with our Listening Assignment.

Detective Dan's Lesson #1 Listening Assignment:

"Innards" is a funny word that means a person's insides. And in this case, it means a person's heart, meant to love and obey God.

I need to know:

1. Who had a rotten heart and knew it? Who had a rotten heart and DIDN'T know it? Many of the people who came to see Jesus knew they had disobeyed God's laws and were sinners. They knew they needed God's forgiveness. The Pharisees were also sinners with "rotten hearts," but they didn't know it. They thought they pleased God with all the laws they kept and all the good things they thought they did.

2. What did Jesus want them all to do? Jesus wanted everyone to turn away from their sins, ask God for forgiveness, and trust in Him as their Savior.

For You and Me:

Just like everyone in Jesus' day, we, too, have sinful "rotten" hearts. We all break God's laws and we need His forgiveness. We can have His forgiveness when we turn away from our sins and trust in Jesus as our Savior. God will forgive our sins and make us His people. Ask God to help you! He loves to answer this prayer!

Detective Dan's Lesson #2 Listening Assignment:**Our Bible Verse is Romans 3:20,21,22,23**

"No one will be declared righteous... by observing the law; But now a righteousness from God, apart from law... comes through faith in Jesus Christ to all who believe... For all have sinned and fall short of the glory of God."

I need to know:

1. Who thought they were justified (good) in God's sight? Why weren't they? The Pharisees thought they were justified in God's sight because they obeyed God's laws and all the extra rules. They weren't justified because no one (except Jesus) keeps God's laws perfectly--and that's the only way to be justified by obeying God's law.

2. What did Jesus want these people to do? He wanted them to understand that they were sinners who needed to turn to God and ask for His forgiveness. He wanted them to trust in Him as their Savior, so they might be saved from their sins.

For You and Me:

Just like the Pharisees, we also cannot be justified (made right with God) by doing good things and trying to obey God's laws. We will never obey them perfectly. We all break God's laws and we need His forgiveness. We can have His forgiveness when we turn away from our sins and trust in Jesus as our Savior. God will forgive our sins and make us His people. Ask God to help you! He loves to answer this prayer!

Detective Dan's Lesson #3 Listening Assignment:

I found six clues, but two of them are **NOT** in the story. They are: a drum, a Pharisee, a golden box, a sick man, the Temple, and a bag of money.

Hold each of them up for the children to see as you identify them.

I need to know:

1. Which four belong in the story and which two don't? The Pharisee, the sick man, the Temple and the bag of money belong. The drum and the golden box do not.

2. What did the bad, bad, bad man pray that pleased God? What did God do for this man? He told God that he was a sinner and asked for God to show him mercy. He knew he needed God's forgiveness. God forgave his sins.

For You and Me:

Like the tax collector, we, too, have sinned against God. We need God to forgive our sins. And God will! How? When we turn away from our sins and trust in Jesus as our Savior. God will forgive our sins and make us His people. Ask God to help you! He loves to answer this prayer!

The Gospel (story wrap-up if NOT using Listening Assignments)**Our Bible Truth is:****What Are God's Laws Like?****God's Laws Are Perfect...****They Show Us that We Need God to Save Us!**

How true that is! We learn God's good laws, but we break them! We choose to disobey God. We all deserve God's punishment for our sins! And we know that we can never deserve His forgiveness. How sad! God would have been perfectly fair to give us all the punishment we deserve for breaking His laws. He is holy and good. But God is so rich in mercy. He chose to give us something better than we deserve. He sent His Son Jesus to live a perfect life. Yes! Jesus kept every, single one of God's laws! And on the cross, He suffered and died, giving His perfect life as the full payment for the sins of all who turn away from their sins and trust in Him as their Savior. On the third day, Jesus rose from the dead. He had really beaten sin and death! Because of Jesus, all who trust in Him as their Savior get to enjoy wonderful, special closeness with God as His special people, even now. And one day, they will go to live with Him forever. We can be God's people when we turn from our sins and trust in Jesus. Ask Him to help you! He loves to do this!

Close in prayer.

Closing ACTS Prayer

- A** We praise You, God, for being the Giver of Your perfectly good laws.
- C** God, instead of obeying Your good laws, we have all chosen to break them. Sometimes, we don't obey our parents. Sometimes, we lie. Sometimes, we want things that belong to others. We do not always love you most of all. These are only some of the ways we break Your good laws. Oh, how we need a Savior!
- T** Thank You, God, for giving us Your good laws, so we know how to love and obey You. And thank You for sending Jesus to perfectly live out Your laws and to give His life as the perfect payment for the sins of Your people. Thank You that He can be our Savior when we turn away from our sins and trust in Him.
- S** God, work in our hearts. Help us to turn away from disobeying You and trust in Jesus as our own Savior. Help us to know You and love You with the spirit You put inside us. Help us to learn Your good laws and obey them. In Jesus' name we pray, Amen.

Big Question 7, Bible Truth 2 Overview: Key Concepts

p.7

Unit 7: The Law-Giving God

Unit Big Question (and Answer): What Are God's Laws Like? God's Laws Are Perfect!

Unit Bible Verse: "The law of the LORD is perfect." Psalm 19:7

Bible Truth 2 Concept: God's Laws Are Perfect... They Show Us that We Need God to Save Us!

God made us and He is in charge of us. He expects us to obey His laws all the time. But sadly, we do not. We all are sinners with sinful, selfish hearts. We disobey God's laws. We deserve His punishment for our sins. How we have rebelled against Him and His good ways!

But God is so kind and merciful! He wants to treat us better than we deserve. He sent Jesus to take the punishment for the sins of all who trust in Him as their Savior. God forgives their sins and gives them special closeness with Him in their hearts. And when they die, they will go to live with Him forever in a perfect world where there will never again be any sin. Yes! They will never again sin against Him or break His good laws. They will always love Him and others as He wants them to. How wonderful that will be! Jesus can be our Savior, too, when we turn away from our sins and trust in Him as our Savior.

Bible Truth 2 Bible Verse: Romans 3:20,21,22,23

"No one will be declared righteous... by observing the law; But now a righteousness from God, apart from law... comes through faith in Jesus Christ to all who believe... For all have sinned and fall short of the glory of God."

Learn a Little: "Righteousness... from God, apart from law... comes through faith in Jesus Christ to all who believe."

Meaning

"Righteous" is a big word that means that you are right with God. The only way we can be right with God ON OUR OWN is by obeying God's laws perfectly. But, uh oh! This Bible verse tells us that we are all sinners who break God's laws. That means we can't EVER be right with God by obeying God's laws.

But God has made a way for us to be right with Him—through His Son, Jesus. Jesus came and lived a perfect life. He kept all of God's good laws perfectly. He was righteous! And this Bible verse tells us that for all who trust in Jesus as their Savior, Jesus takes away their sins and gives His righteousness to them. That means God treats them as if they had never broken God's laws or sinned-- just like Jesus! Wow! Isn't that amazing! Isn't Jesus a wonderful Savior! He can be our wonderful Savior, too, when we turn away from our sins and trust in Him as our Savior.

Bible Truth 2 ACTS Prayer

- A** We praise You, God, for being the Giver of Your perfectly good laws.
- C** God, instead of obeying Your good laws, we have all chosen to break them. Sometimes, we don't obey our parents. Sometimes, we lie. Sometimes, we want things that belong to others. We do not always love you most of all. These are only some of the ways we break Your good laws. Oh, how we need a Savior!
- T** Thank You, God, for giving us Your good laws, so we know how to love and obey You. And thank You for sending Jesus to perfectly live out Your laws and to give His life as the perfect payment for the sins of Your people. Thank You that He can be our Savior when we turn away from our sins and trust in Him.
- S** God, work in our hearts. Help us to turn away from disobeying You and trust in Jesus as our own Savior. Help us to know You and love You with the spirit You put inside us. Help us to learn Your good laws and obey them. In Jesus' name we pray, Amen.

Bible Truth 2 Story

The Case of the Rotten Innards Luke 18:9-14

Songs Used in Bible Truth 2

Big Q & A 7 Song

Big Question 7 Song: What Are God's Laws Like?

Big Question 7 Bible Verse Song: The Law of the Lord Is Perfect Psalm 19:7

Big Question 7 Hymn: Holy Bible, Book Divine

Big Question 7 Praise Song: The Best Book to Read Is the Bible

Bible Truth 2 Bible Verse Song: Observing the Law Romans 3:20-23, NIV 1984

Extra Bible Truth 2 Bible Verse Song: For Christ Died for Sins 1 Peter 3:18, NIV 1984

Extra Bible Truth 2 Bible Verse Song: The Lord Looks Down Psalm 14:2-3, NIV 1984

listen to or download songs for free at <https://praisefactory.org>: Deep Down Detectives Music page