

Hide 'n' Seek Kids

"Give It A Go"

Unit 1

Visual Aids

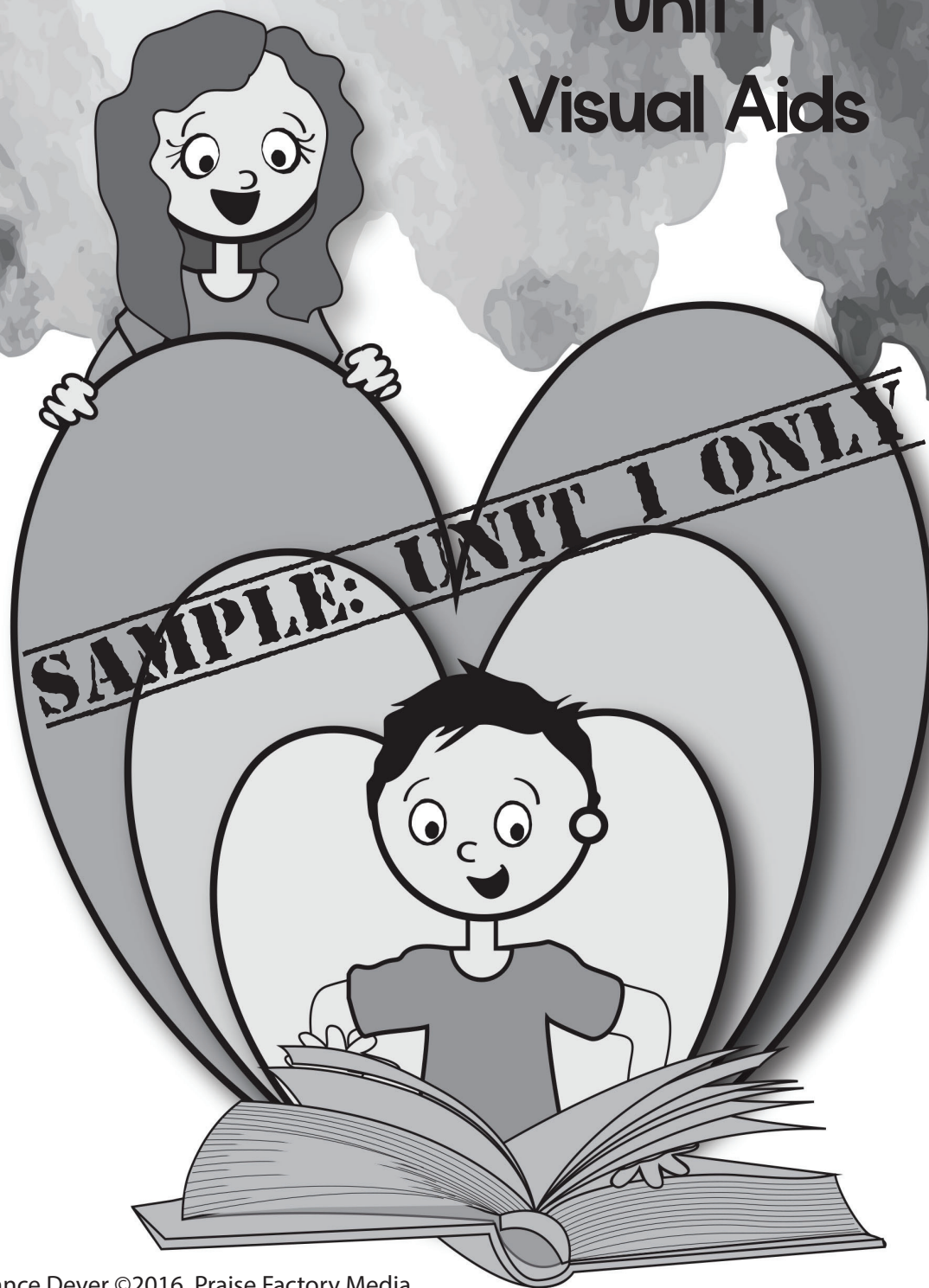



Curriculum for preschool and elementary age children,
training tools, music and other resources
are available for download or to order at:
www.praisefactory.org

© 2015 Praise Factory Media all rights reserved. May be reproduced by licensed user for classroom purposes only.

This and many other resources are available online at www.praisefactory.org

Scripture quotations marked (NIV) are taken from the Holy Bible, New International Version®, NIV®, Copyright © 1973, 1978, 1984 by Biblica, Inc.™ Used by permission of Zondervan. All rights reserved worldwide.www.zondervan.com

Scripture quotations marked (ESV) are from The Holy Bible, English Standard Version® (ESV®), copyright © 2001 by Crossway, a publishing ministry of Good News Publishers. Used by permission. All rights reserved.

Scripture quotations marked HCSB are taken from the Holman Christian Standard Bible®, Copyright © 1999, 2000, 2002, 2003, 2009 by Holman Bible Publishers. Used by permission. Holman Christian Standard Bible®, Holman CSB®, and HCSB® are federally registered trademarks of Holman Bible Publishers.

Table of Contents

About the “Give-It-a-Go” Materials	4
Getting Started with Hide ‘n’ Seek Kids	5
Unit 1 Visual Aids	7
About the Hide ‘n’ Seek Kids Visual Aids	8
Story	9
Big Question and Answer	15
Bible Verse	17
Detective Dan’s Listening Assignment #1	19
Detective Dan’s Listening Assignment #2	21
Detective Dan’s Listening Assignment #3	23
Detective Dan’s Listening Assignment #4	29
Detective Dan’s Listening Assignment #5	31
Storyboard Pictures Key	33
Storyboard Pictures Placement Guide	35
Storyboard Pictures	37
Other Visual Aids	57
Making the Hide ‘n’ Seek Bible Folder	58
Hide ‘n’ Seek Kids Bible Folder Picture Front Cover	59
Hide ‘n’ Seek Kids Bible Folder Picture Back Cover	61
Making a Flannelgraph Storyboard	63
Making Durable Storyboard Pictures	63
Making a Big Question Box/Briefcase	64

About the “Give-It-A-Go” Materials

Hello, New Friend to Hide ‘n’ Seek Kids!

If you have gotten this far, chances are you are looking fairly seriously at this curriculum. Rather than having you download or purchase the full versions of the curriculum, I’ve put together this bundle of materials that will give you a chance to really understand it and to try it out.

This packet is a sort of “mini me” of resources available for each unit of Hide ‘n’ Seek Kids.

Included in this packet:

TOUR OF PRAISE FACTORY FAMILY OF CURRICULUM:

1. Black and White pdf of The Praise Factory Tour: Extended Version

(The color version is a huge document that would take a very long time to download). This book is your guide to understanding the curriculum basics. You can also order it through amazon in color or watch the slideshow in the Get Started section of the praisefactory.org website. But sometime, you just want something to get your hands on now! So here it is!

CORE CURRICULUM:

2. Give-It-A-Go Hide ‘n’ Seek Kids Core Curriculum for Unit 1

The regular volume includes Units 1-4--more than you need if you are only in the test-drive stage.

VISUAL AIDS OPTIONS:

3. Give-It-A-Go Hide ‘n’ Seek Kids Visual Aids with Simple Story Scenes for Unit 1

(Excerpt from Hide ‘n’ Seek Kids Volume 1 (Units 1-4) Visual Aids with Simple Story Scenes, ESV)

The regular book includes visual aids for Units 1-4--more than you need if you are only in the test-drive stage. This file is in color, because it includes all the colorful stuff! You can choose to print it out in black and white, if you want to save on ink.

Note: You can also get just the Simple Story Scenes without the other Visual Aids.

4. Give-It-A-Go Hide ‘n’ Seek Kids Visual Aids with Storyboard Pictures for Unit 1

(Excerpt from Hide ‘n’ Seek Kids Volume 1 (Units 1-4) Visual Aids with Small Format Storyboard Pictures, ESV)

The regular volume includes Units 1-4--more than you need if you are only in the test-drive stage. This file is in color, because it includes all the colorful stuff! You can choose to print it out in black and white, if you want to save on ink.

Note: These are pictures from the Small Format Visual Aids book for Unit 1. They are great for a felt storyboard that is in the 24” x 36” to 36” x 48” range. There are also larger versions of these pictures in the Unit 1 Visual Aids books. Those larger pictures are for storyboards no smaller than 36” x 48”.

Music Resources:

5. Give-It-A-Go Hide ‘n’ Seek Kids audio music files for Unit 1

Enjoy!

Hide 'n' Seek Kids Curriculum Resources

There are five companion resources for each of the four volumes of Hide 'n' Seek Kids. (Each volume contains four units. There are sixteen units in total in the curriculum.) Use whichever resources are useful to your setting. Hide 'n' Seek Kids resources are available as free, digital downloads at praisefactory.org, or for purchase as hard copies through amazon.com.

Make sure to check out the "Bits and Pieces" section of the Hide 'n' Seek Kids curriculum online. It has all of the resources separated out making it easy for you simply to pick, choose and print out whatever you want.

Hide 'n' Seek Kids Core Curriculum Book, ESV/NIV for each volume

The Hide 'n' Seek Kids Core Curriculum book contains the curriculum introduction, the lesson plans, stories, music, activities and take home sheets for each of the units.

Hide 'n' Seek Kids Visual Aids with Simple Story Scenes, ESV/NIV for each volume

This resource provides large, colorful signs of the key concepts used in the unit, PLUS, easy-to-use, colorful scenes that you hold up in sequence as you tell the story. The story text for each scene is printed on the bottom of each scene.

Hide 'n' Seek Kids Simple Story Scenes, ESV/NIV for each volume

This resource includes only 2-page overview for Bible Truth, the stories, and the story scenes. This is a great, basic resource for use at home or informal teaching situations.

Hide 'n' Seek Kids Small Format Visual Aids, ESV/NIV (Small Format Storyboard Pictures) for each volume

This resource provides large, colorful signs of the key concepts used in the unit, PLUS, colorful storyboard (flannelgraph) pictures to cut out and use as you tell each story. These storyboard pictures are for use with storyboards at least 24" x 36" in size.

Hide 'n' Seek Kids Large Format Visual Aids, ESV/NIV (Large Format Storyboard Pictures) for each volume

This resource provides large, colorful signs of the key concepts used in the unit. It also provides colorful storyboard (flannelgraph) pictures to cut out and use as you tell each story. These storyboard pictures are for use with storyboards 36" x 48" in size.

All of these materials may be photocopied for non-commercial church, classroom or school use by licensed users.

Other Resources in the Praise Factory Family of Curriculum

Hide 'n' Seek Kids is the first in a family of three, inter-related curriculums:

- Hide 'n' Seek Kids (focus group: ages 2-4; adaptable range: ages 2-pre-K 5's)
- Deep Down Detectives (focus group: ages 4--6's; adaptable range: ages 3-2nd grade)
- PFI: (focus group: grades K-5th grade; adaptable range: pre-K 5's-6th grade)

Each curriculum teaches the same biblical themes, but are presented in greater depth as the children grow and develop. Together, the curriculums work like an expanding spiral of truth that returns to reinforce the same truths with each curriculum, yet leading the children to deeper understanding with each step up.

Learn more about these curriculums as well as other resources and ideas for reaching children with the gospel at: www.praisefactory.org.

Hide 'n' Seek Kids

Unit I Visual Aids



About the Hide 'n' Seek Kids Visual Aids

How Are They Used?



The Hide 'n' Seek Visual Aids book is a companion resource to be used alongside the Hide 'n' Seek Kids Core Curriculum book for each unit. These colorful pictures are used in presenting the key concepts; telling the Bible stories; and, in playing the Bible Story Review games.

What Do They Include?

There are five, different resources included in this book:

1. Key Concept Visual Aids-- colorful signs of the Big Question and Answer, the Bible verse, and the Listening Assignments to use with the 5 lessons for each unit.

2. The Storyboard Picture Key--a who's who of the pictures in thumbnail size. Some pictures are labelled "BG." These are your background pictures that you put on the storyboard before telling the story. The rest of the pictures are labelled "SB." These are pictures you put up on the storyboard as you tell the story.

3. Storyboard Suggested Picture Placement page--where to place the pictures on your storyboard.

4. The pictures, themselves. Notice that each picture is identified and numbered on the back for easy reference. The numbers correspond to the numbers in the Picture Placement Key and in the actually story script (found in the Core Curriculum book.)

5. Directions for making the Hide 'n' Seek Kids "Bible" Folder and the **back/front images** to paste in place when making it. (Larger back/front images are found online with the curriculum.)

(**Directions** for how to make a homemade flannelgraph storyboard and sturdy storyboard pictures are found in **Appendix E in the Core Curriculum book.**)



Ready, Set, Rip It Out!

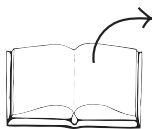

This book is meant to be ripped up and made into your visual aids. The key concept signs can be cut out and laminated or slipped into sheet protectors. Cut out around the storyboard images and ideally, laminate these. Some of the biggest pictures actually need to be stuck together, before laminating.

Store It!



Hide 'n' Seek Kids is a curriculum that can be used over and over. Store your visual aids and storyboard pictures after using them and they will serve you for many years. We store ours in manilla envelopes and then put them (along with all the rest of the curriculum) in magazine files, labelled by unit. If you have multiple classes using the curriculum, store each set of resources in separate manilla envelopes. This will make prep much simpler, second time around.

Replacement Storyboard Pictures



You can always purchase this book again or simply go online and print out any pictures that go missing.

Two Sizes of Storyboard Pictures



There are two sizes of storyboard pictures to choose from: the standard, large format pictures; or, the smaller format pictures. The larger pictures are best for a big classroom and a storyboard that is at least 36" x 48." (We actually make a whole section of a wall into a felt storyboard!) The small format pictures are created to fit smaller storyboards--in the 24" x 36" to 36" by 48" range. They are most useful in the smaller class or for use at home.

The Case of the Old Man Who Looked for God*Luke 2:25-32*

of BQB

Story-telling Tips

Ahead of time:

1. Read the Bible verses and story. Pray!
2. Choose story action cues and/or prepare storyboard pictures, if using. (Included in Visual Aids book)
3. Practice telling story with the pictures, timing your presentation. Shorten, if necessary to fit your allotted time.

During your presentation:

1. Maintain as much eye contact as possible as you tell the story.
2. Put up storyboard figures/add story action cues as you tell the story. Allow the children to help you put them on the board, if desired.
3. Include the children in your story with a few questions about what they think will happen or words/concepts that might be new to them.
4. Watch the kids for signs that their attention span has been reached. Shorten, if necessary.

INTRODUCTION/ LISTENING ASSIGNMENTS

“Our story is called: The Case of the Old Man Who Looked for God. Here is your listening assignment... ”

Read from Detective Dan’s Listening Assignment signs, but questions are summarized below:

Detective Dan’s Lesson #1 Listening Assignment:

I need to find out:

1. Who was the old man who looked for God?
2. How did he find out what God was like?

Detective Dan’s Lesson #2 Listening Assignment:

Our Bible verse is Amos 4:13: “He who declares to man what is His thought...The LORD, the God of hosts, is His name.”

I need to find out:

1. Who did the LORD declare His thoughts to?
2. What book did the LORD use to declare His thoughts?

Detective Dan’s Lesson #3 Listening Assignment:

I found four clues, but one of them is NOT in the story.

They are: baby Jesus, a chair, God’s Word (on a scroll, like in Bible times) and a heart.

Hold up each of the four pictures for the children to see as you identify them. Better yet, put them up on your flannelgraph storyboard, off to one side.

I need to figure out:

1. Which three pictures belong in the story and which one does not?
2. What did God use three of these things to show Simeon?

Detective Dan’s Lesson #4 Listening Assignment:

I need to find out:

1. Who did Simeon want to know more and more?
2. What was something Simeon thanked God for?

Detective Dan’s Lesson #5 Listening Assignment:

I need to find out:

1. Why was Simeon so happy to see baby Jesus?
2. What did God send Jesus to do?

Read the questions, THEN SAY,

“Ok, Hide ‘n’ Seekers! Put on your best listening ears and see if you can find the answers to Detective Dan’s questions. When I finish telling the story, we’ll see what we come up with.”

“The Case of the Old Man Who Looked for God” Luke 2:25-32

Story with lines separating paragraphs (text in bold, optional interaction cues in italics) Numbers correspond to storyboard pictures and placement upon the storyboard. Always feel free to use less pictures, if it's best for your kids. Simply, black out the numbers next to pictures you do not plan to use. All pictures are found in the Visual Aids book. Put BG (background) pictures on storyboard ahead of time. SB pictures (listed below in story text) are added to board as you tell the story. These numbers are also found on the back of each picture.

Tip: Stack pictures in numerical order before telling story for easy use. Use sticky-back velcro to attach pictures to storyboard felt. Use sticky-tac putty to stick a picture on top of another picture.

Simeon (SB1) was a very, very old man.

Have you seen a very old man? They often have gray hair and sometimes even have a long, grey beard. Simeon looked like that!

Simeon knew and loved God in his heart (SB2).

Can you point to where your heart is?

But oh, how Simeon wanted to know more about God and what He is like!

Simeon knew God created the whole world. He could learn more about God, as he looked at all that God had made. There was so much to see!

The big, tall mountains,

Can you stretch up your arms really high like a tall mountain?

the (SB3) galloping horses,

When horses gallop they run really, really fast and make lots of noise with their feet. Can you stomp your feet like you were a galloping horse?

the (SB4) flying birds,

Let's flap our arms like birds!

the (SB5) buzzing bees.

What sound does a buzzing bee make?

Simeon could see how wonderful God was in all the things He had made. But oh, how Simeon wanted to know more about God and what He is like!

Simeon read the Bible, God's Word, (SB6), too.

Where's our Bible? Have children point to your Bible.

He learned that God is good and great, loving and wise.

But oh, how Simeon wanted to know more about God and what He is like!

Story with lines separating paragraphs (text in bold, optional interaction cues in italics)

Then one day, something very good happened to Simeon. God gave Simeon a wonderful promise: "I am sending My Son, Jesus, here to earth. He will show people what I am like, and will make the way for them to know and love Me. He will bring My forgiveness to everyone who trusts in Him as their Savior! They will know Me in their heart. Then one day, they will come to live happily with Me forever!" God promised. "And Simeon, you will get to see My Son, Jesus at my Temple-Church before you die!" God told Simeon.

Simeon gathered with other people to worship God at a special place called the Temple. Where do we gather together to worship God? Why, it's right here! We're in it now! It's a church!

How excited Simeon was! Oh, how wonderful it would be to see God's very own Son!

Simeon went to God's Temple-Church.

Walk! Walk! Walk! Here goes Simeon to God's Temple-Church. Can you make a walking noise with your feet?

And who did Simeon see when he got there? Mary and Joseph (SB7). And who were they carrying? Baby Jesus, God's Son!

Pretend to hold a baby in your arms.

Simeon was very happy to see baby Jesus, God's Son, just as God had promised!

Yes, there was Jesus, just a little baby! But Jesus wouldn't stay a baby. He would grow up, up, up (SB8). He would tell everyone about God (SB9). He would show them what God is like. And, He would die on the cross to save God's people. They would be forgiven by God for disobeying Him! Yay!

Let's cheer really loud! Yay!

Then on Day One, Two, Three, (SB10) Jesus would rise up from the dead, showing He had really done it! Yes, God's people were forgiven! Jesus had beaten sin and death for them! Yay!

Let's cheer really loud again! Yay!

One day, old Simeon died (SB11). Was that a sad day for Simeon? No, it was not!

Shake your head "no."

That was the day when God brought (SB12) Simeon to live with (SB13) Him in heaven. That's what made that day, Simeon's happiest day ever.

Now Simeon would really get to know how wonderful God is... more and more, forever and ever!

Simeon is so happy in heaven where he lives happily with God forever. Let's cheer really loud! Yay!

Cracking the Case: (story wrap-up for Listening Assignments)

It's time to see how we did with our Listening Assignment.

Detective Dan's Lesson #1 Listening Assignment:

1. Who was the old man who looked for God?

Simeon.

2. How did he find out what God was like?

He knew God in his heart; he saw what God was like as he looked around him at the things God had made; he learned about Him in the Bible, God's Word; and most of all, he knew what God was like through His Son, Jesus.

For You and Me:

Like Simeon, we can know what God is like. God has given us a heart to know and love Him. We can look around us and see what He's like in the things He has made. We can learn about Him in the Bible; and, we can know what He's like most of all when we learn about Jesus. We can ask God to show us what He's like and help us to know and love Him. He delights to do this!

Detective Dan's Lesson #2 Listening Assignment:

Our Bible Verse is: Amos 4:13:

"He who declares to man what is His thought...The LORD, the God of hosts, is His name."

1. Who did the LORD declare His thoughts to?

Simeon.

2. What book did the LORD use to declare His thoughts? The Bible, God's Word.

For You and Me:

The LORD can show us what He's like, through the special hearts He gave us, as we look around at all the amazing things He has made. He can declare His thoughts to us as we read the Bible, His Word and learn about His Son, Jesus Ask God to show Himself to you! He delights to do this!

Detective Dan's Lesson #3 Listening Assignment:

I found four clues, but one of them is NOT in the story. They are: baby Jesus, a chair, God's Word (on a scroll, like in Bible times) and a heart.

I need to know:

1. Which three pictures belong in the story and which one does not? The chair does not belong.

2. What did God use three of these things to show Simeon? God used baby Jesus, the Bible and the heart He gave Simeon to show Simeon what He is like.

For You and Me:

The LORD wants to show us what He's like, too. He can use the heart He's given us, the Bible, and Jesus to show us what He's like, too.

Detective Dan's Lesson #4 Listening Assignment:

1. Who did Simeon want to know more and more about? God.

2. What was something Simeon thanked God for? Simeon thanked God for keeping His promise to let him see Jesus before he died. He was so happy to know that the time had come for God to save His people through Jesus.

For You and Me:

Like Simeon, we can thank God for sending Jesus to save sinners, like you and me.

Detective Dan's Lesson #5 Listening Assignment:

1. Why was Simeon so happy to see baby Jesus? He knew that the time had come for God to save God's people from their sins through Jesus.

2. What did God send Jesus to do? God sent Jesus to show us what He's like. And, to take the punishment for the sins of God's people so they could know God and be His people forever.

For You and Me:

God can show us what He's like through His Son, Jesus. Jesus can save us from our sins and make us God's people, too, when we repent of our sins and trust in Him as our Savior.

The Gospel (story wrap-up if NOT using Listening Assignments)**Our Bible Truth is:****How Can I Know What God Is Like?****He Shows Me What He's Like!**

God showed Simeon what He is like, and He can show us, too! We can ask Him to work in our heart and help us to turn away from disobeying Him and trust in Jesus as our Savior. When we do, God will forgive our sins and save us! He will live in our heart, helping us to know Him right now. He will satisfy our heart, giving us a special kind of happiness that comes only from knowing Him. And one day, we will go to live with Him in heaven forever. That will be best of all!

Close in prayer.

Closing Unit 1 ACTS Prayer

A=Adoration C=Confession T=Thanksgiving S=Supplication

- A** We praise You, God. You show us what You are like!
- C** LORD, in our heart we know that You are God. We know we should obey You, but many times we don't want to. Please forgive us. We need a Savior!
- T** Thank You for wanting us to know You. Thank You for giving us a heart to know You; and, for making this world that shows us what You are like. Thank You for what we learn about You in Your Word, the Bible. And most of all, thank You for showing us what You are like in Your Son, Jesus.
- S** Work deep inside our hearts. Help us to turn away from our sins and trust in Jesus as our Savior. Help us to know You. Put in our hearts the special kind of happy that comes only from knowing You. Help us to go and tell others what we've learned.

In Jesus' name we pray. Amen.

***Return to page 7 of the Lesson Plan
for the script of the rest of this lesson.***



How can I know what God is like?



ANSWER:

He shows me what He's like!

VISUAL
AID

#1

take out



of BQB

The Big Question

Hold up the Big Question sign for all the children to see, and say:

The Big Question we are investigating today is
Big Question Number 1:

How Can I Know What God Is Like?

and the Answer is:

He Shows Me What He's Like!

Meaning:

God made us. He wants us to know what He is like so we can know Him, love Him, and praise Him.

God shows us what He is like by the heart He gave us to know and love Him; through all of His creations we see around us; through His Word, the Bible; and most of all, through His very own Son, Jesus Christ.

Let's sing our Big Question Song: "

Big Q & A I Song

HSK ESV Songs 1, track 12

(adapted version of "This is the Way We Wash Our Clothes")

How can I know what God is like,
God is like, God is like?

How can I know what God is like?
He shows me what He's like!

VISUAL
AID

#2

Place
verse in
take out



of BQB

HSK Bible
Folder

The LORD!

"He who declares to man His thought. The LORD, the God of hosts, is His name." Amos 4:13, ESV

Unit 1 Bible Verse

“Who would like to get our Bible verse out of the Big Question Briefcase for me?”

Choose a child to open the briefcase, take out the “Bible” with the Bible Verse in it and hand it to you. Remove the Bible Verse Picture from the “Bible” (held in place by velcro) and hold it up for all the children to see, then say:

Amos 4:13

“He who declares to man what is His thought...The LORD, the God of hosts, is His name.”

Meaning:

God wants us to know what He is like so we can know Him, love Him, and praise Him. We don't have to figure out what God is like by ourselves. God show us what He's like--He declares His thoughts to us.

God shows us what He's like through the spirit He put in our hearts; through His creations we see around us; through His Word, the Bible; and most of all, through His very own Son, Jesus Christ.

And what's the name of the one and only true, living God? It's the LORD! Yes, the LORD is His name!

“We've said our Bible verse, now let's sing it!”

He Who Declares His Thought:

Amos 4:13

HSKESV Songs 1, track 14, 14T

He who declares His thought,
He who declares His thought to man.
He who declares His thought,
He who declares His thought to man.
The LORD, the LORD, is His name.
The LORD, the LORD, is His name.
Amos Four, thirteen.

“Now it's time to do a bit more deep down investigating. Let's read Detective Dan wants us to help him figure out. Would someone like to get it out for me?”

VISUAL
AID

#3

Place
verse in



HSK Bible
Folder

take out



Big
Question
of BQB

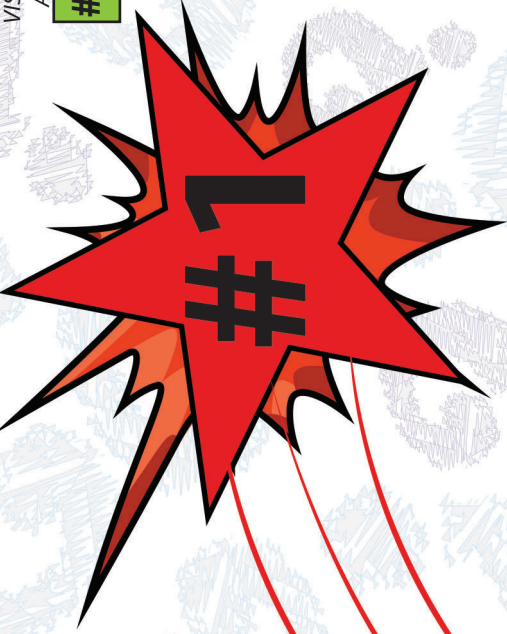

Detective Dan's Listening Assignment #1

Detective Dan's Listening Assignment #1



Hi, Hide 'n' Seek Kids!

I'm working on a brand-new case called:

"The Case of the Old Man Who Looked for God."

I need to find out:

1. Who was the old man who looked for God?

AND

2. How did he find out what God was like?

Can you help me? Listen carefully to the story and you might just hear the answers!

Thanks!

Detective Dan

Then say, "Ok, Hide 'n' Seekers! Put on your best listening ears and see if you can find the answers to Detective Dan's questions. When I finish telling the story, we will see if we can answer all of his questions."

Read the Bible Truth story, putting up the storyboard pictures as you tell it.

At the end of the story, repeat the questions and lead the children in answering them. Present the gospel and close in prayer.

Answers to assignment questions, the gospel and ACTS prayer are also included at the end of the story text.

Answers:

1. Who was the old man who looked for God?

Simeon.

2. How did he find out what God was like?

He knew God in his heart; he saw what God was like as he looked around him at the things God had made; he learned about Him in the Bible, God's Word; and most of all, he knew what God was like through His Son, Jesus.

For You and Me:

Like Simeon, we can know what God is like. God has given us a heart to know and love Him. We can look around us and see what He's like in the things He has made. We can learn about Him in the Bible; and, we can know what He's like most of all when we learn about Jesus. We can ask God to show us what He's like and help us to know and love Him. He delights to do this!

VISUAL
AID

Place
verse in
take out



HSK Bible
Folder



Detective Dan's Listening Assignment #2

Detective Dan's

Listening Assignment #2



Hi, Hide 'n' Seek Kids!

I'm still working on the case called:

"The Case of the Old Man Who Looked for God."

Our Bible verse is Amos 4:13: "He who declares to man what is His thought...The LORD, the God of hosts, is His name."

I need to find out:

1. Who did the LORD declare His thought to?

AND

2. What book did the Lord use to declare His thought?

Can you help me? Listen carefully to the story and you might just hear the answers!

Thanks for your help!

Detective Dan

Then say. "Ok, Hide 'n' Seekers! Put on your best listening ears and see if you can find the answers to Detective Dan's questions. When I finish telling the story, we will see if we can answer all of his questions."

Read the Bible Truth story, putting up the storyboard pictures as you tell it.

At the end of the story, repeat the questions and lead the children in answering them. Present the gospel and close in prayer.

Answers to assignment questions, the gospel and ACTS prayer are also included at the end of the story text.

Answers:

Our Bible Verse is: Amos 4:13

"He who declares to man what is His thought...The LORD, the God of hosts, is His name."

1. Who did the LORD declare His thought to?

Simeon.

2. What book did the Lord use to declare His thought? The Bible, God's Word.

For You and Me:

The LORD can show us what He's like, through the special hearts He gave us, as we look around at all the amazing things He has made. He can declare His thoughts to us as we read the Bible, His Word and learn about His Son, Jesus Ask God to show Himself to you! He delights to do this!

VISUAL
AID

#5A

Place
verse in
take out

HSK
Bible
Folder
of BQB
HSK Bible
Folder



Detective Dan's Listening Assignment #3

Detective Dan's

Listening Assignment #3



Hi, Hide 'n' Seek Kids!

I'm still working on the case called:

"The Case of the Old Man Who Looked for God."

I found four clues, but one of them is NOT in the story. They are: baby Jesus, a chair, God's Word (on a scroll, like in Bible times) and a heart.

Hold up each of the four pictures for the children to see as you identify them. Better yet, put them up on your flannelgraph board, off to one side.

I need to know:

- 1. Which THREE pictures belong in the story and which ONE does NOT?**
- 2. What did God use three of these things to show Simeon?**

Can you help me? Listen carefully to the story and you might just hear the answers!

Thanks!

Detective Dan

Then say, "Ok, Hide 'n' Seekers! Put on your best listening ears and see if you can find the answers to Detective Dan's questions. When I finish telling the story, we will see if we can answer all of his questions."

Read the Bible Truth story, putting up the storyboard pictures as you tell it.

At the end of the story, repeat the questions and lead the children in answering them. Present the gospel and close in prayer.

Answers to assignment questions, the gospel and ACTS prayer are also included at the end of the story text.

Answers:

- 1. Which three pictures belong in the story and which one does not?** The chair does not belong.
- 2. What did God use three of these things to show Simeon?** God used baby Jesus, the Bible and the heart He gave Simeon to show Simeon what He is like.

For You and Me:

The LORD wants to show us what He's like, too. He can use the heart He's given us, the Bible, and Jesus to show us what He's like, too.



Baby Jesus

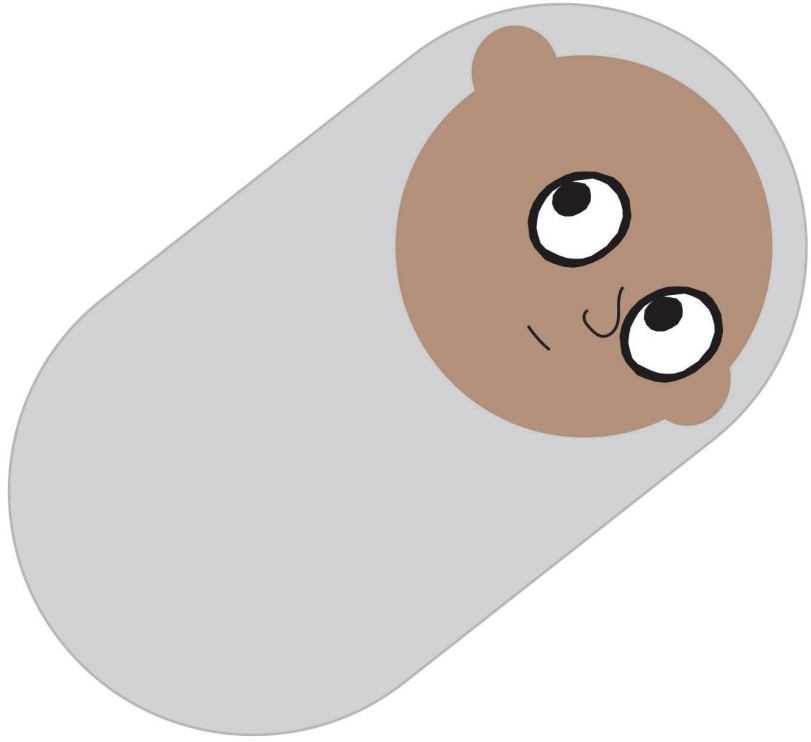

Chair

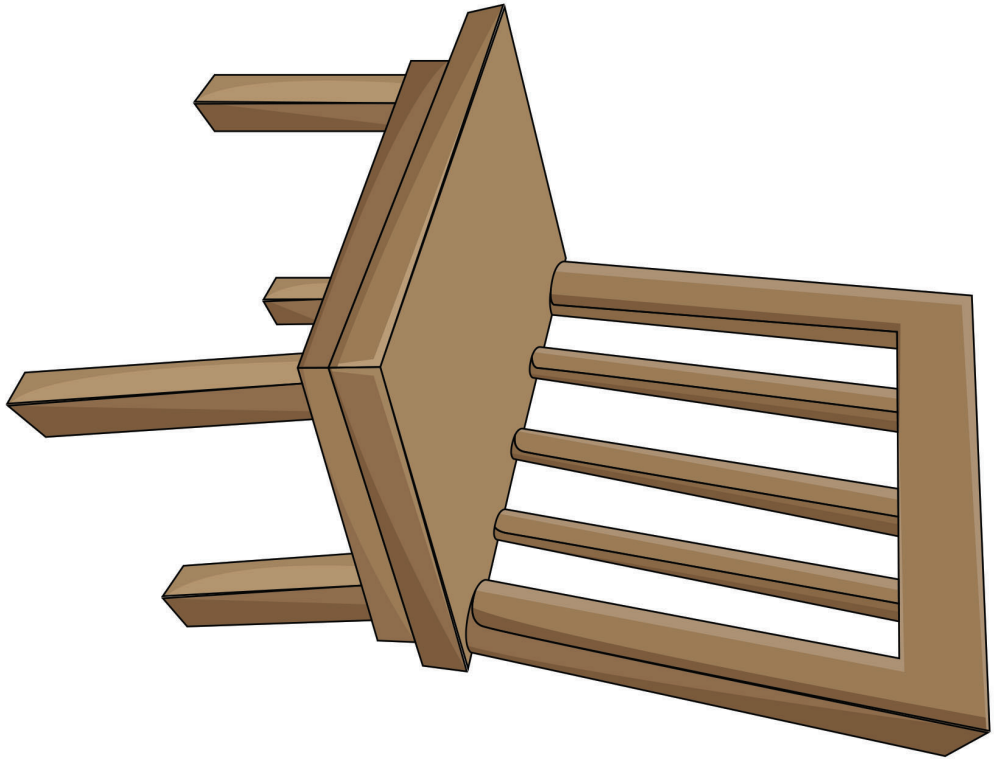



HSK 1 Lesson 3 Listening Assignment Clue Picture 2 for kids

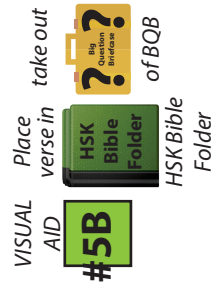

HSK 1 Lesson 3 Listening Assignment Clue Picture 1 for kids



God's Word, the Bible

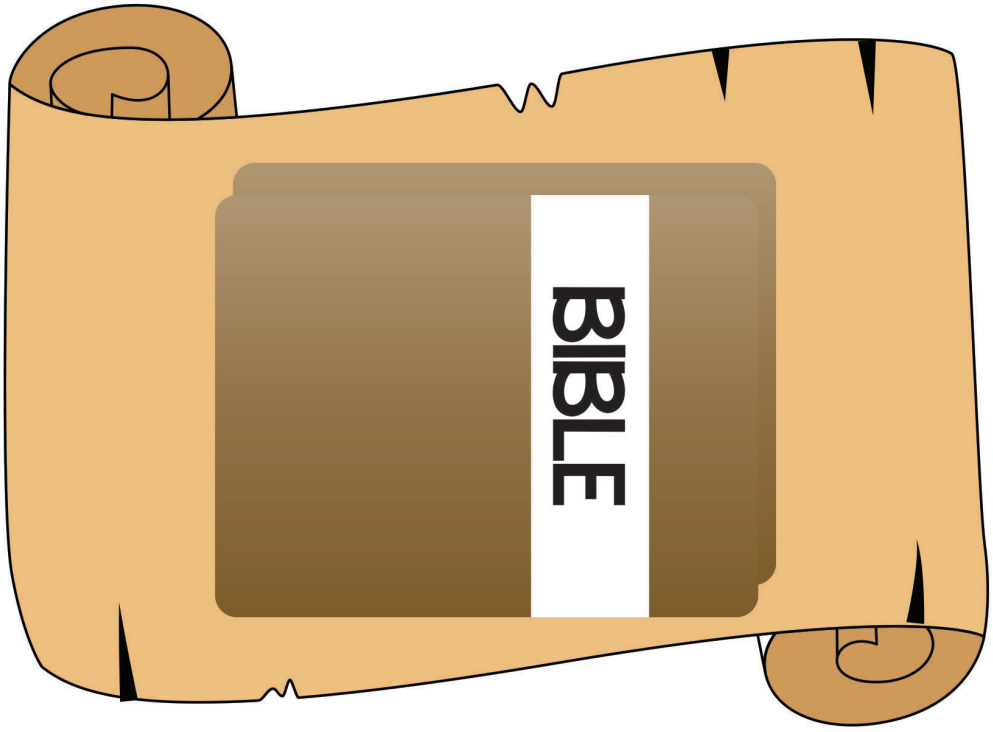

Heart

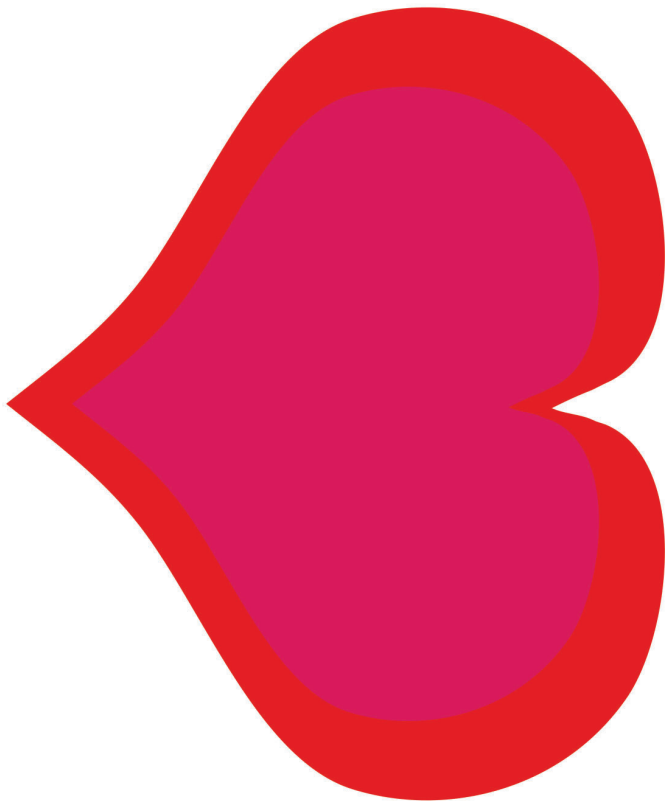



HSK 4 Lesson 3 Listening Assignment Clue Picture 3 for kids



HSK 4 Lesson 3 Listening Assignment Clue Picture 4 for kids

VISUAL
AID

Place
verse in

take out

#6

HSK Bible
Folder

HSK Bible
Folder

of BQB

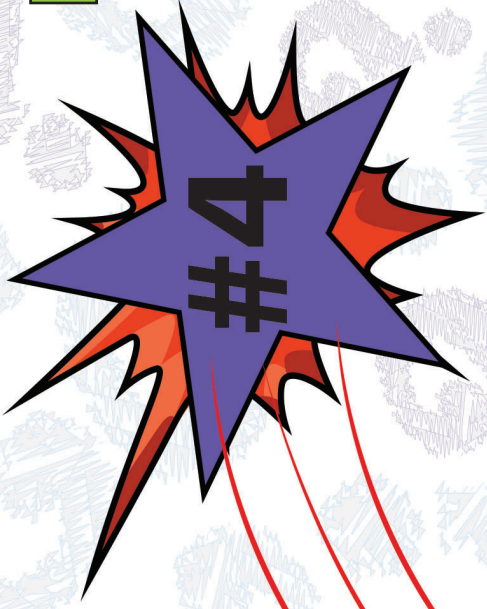

Detective Dan's Listening Assignment #4

Detective Dan's Listening Assignment #4



Hi, Hide 'n' Seek Kids!

I'm still working on the case called:

"The Case of the Old Man Who Looked for God."

I need to find out:

1. Who did Simeon want to know more and more?
AND
2. What was something Simeon thanked God for?

Can you help me? Listen carefully to the story and you might just hear the answers!

Thanks!

Detective Dan

Then say, "Ok, Hide 'n' Seekers! Put on your best listening ears and see if you can find the answers to Detective Dan's questions. When I finish telling the story, we will see if we can answer all of his questions."

Read the Bible Truth story, putting up the storyboard pictures as you tell it.

At the end of the story, repeat the questions and lead the children in answering them. Present the gospel and close in prayer.

Answers to assignment questions, the gospel and ACTS prayer are also included at the end of the story text.

Answers:

1. Who did Simeon want to know more and more about? God.
2. What was something Simeon thanked God for? Simeon thanked God for keeping His promise to let him see Jesus before he died. He was so happy to know that the time had come for God to save His people through Jesus.

For You and Me:

Like Simeon, we can thank God for sending Jesus to save sinners, like you and me.

VISUAL
AID

#7

Place
verse in
take out



of BQB
Folder



Detective Dan's Listening Assignment #5

Detective Dan's Listening Assignment #5

#5



Hi, Hide 'n' Seek Kids!
I'm still working on the case called:
"The Case of the Old Man Who Looked for
God."

I need to find out:

1. Why was Simeon so happy to see baby Jesus?
AND
2. What did God send Jesus to do?

Can you help me? Listen carefully to the story and
you might just hear the answers!

Thanks!
Detective Dan

Then say. "Ok, Hide 'n' Seekers! Put on your best listening ears and see if you can find the answers to Detective Dan's questions. When I finish telling the story, we will see if we can answer all of his questions."

*Read the Bible Truth story, putting up the storyboard pictures as you tell it.
At the end of the story, repeat the questions and lead the children in answering them. Present the gospel and close in prayer.*

Answers to assignment questions, the gospel and ACTS prayer are also included at the end of the story text.

Answers:

1. **Why was Simeon so happy to see baby Jesus?** He knew that the time had come for God to save God's people from their sins through Jesus.
2. **What did God send Jesus to do?** God sent Jesus to show us what He's like. And, to take the punishment for the sins of God's people so they could know God and be His people forever.

For You and Me:

God can show us what He's like through His Son, Jesus. Jesus can save us from our sins and make us God's people, too, when we repent of our sins and trust in Him as our Savior.

HSK I Storyboard Picture Key: Background Pictures (BG)

Put these pictures in place on your storyboard BEFORE you tell your story.

BG1 Mountains



BG2 Temple

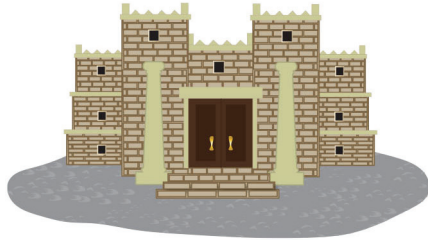

**BG3 Cross/
Resurrection
Scene**



**BG4
Heaven**



NOTE:

These samples are from the SMALL FORMAT Volume 1 Visual Aids, ESV book. Best for storyboards 24" x 36" to 36 x 48". These work great for use at home or with a smaller class.

The Volume 1 Visual Aids books are another version of the pictures. They are for use on storyboards AT LEAST 36" x 48" in size. These are best for a large class.

HSK I Storyboard Picture Key: Storyboard Pictures (SB)

Store these pictures in numerical order in your HSK Bible Folder.
Add these to your story as you tell it. Numbers correspond to placement order.

SB1 Simeon



SB8 Jesus Growing Up

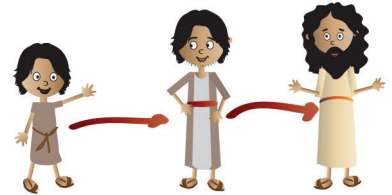

SB2 Simeon's Heart that Knows God



SB9 Jesus Teaching People



SB3 Galloping Horses



SB10 Jesus, Risen



SB4 Flying Birds



SB11 Simeon Dead



SB5 Buzzing Bees



SB12 Simeon in Heaven



SB6 Scroll of God's Word, the Bible



SB13 Jesus in Heaven



SB7 Simeon with Mary, Joseph, and Baby Jesus

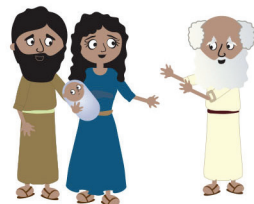

Note: Use sticky tac putty rather than velcro on back of pictures placed on top of other pictures.



SB5

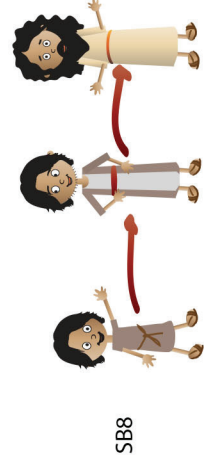
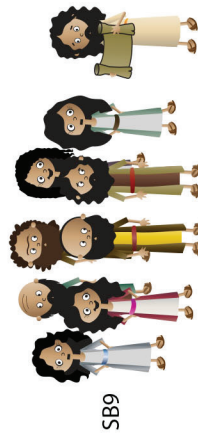
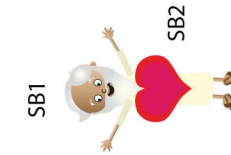
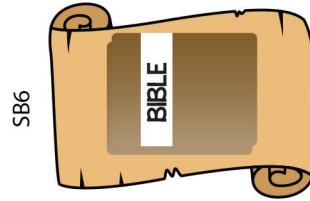
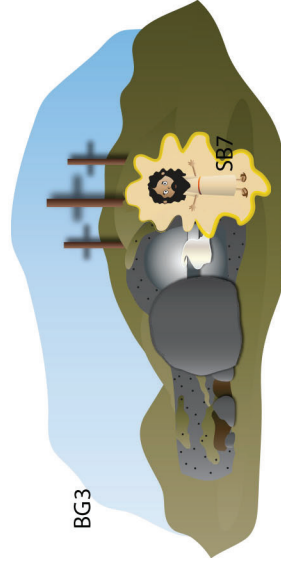
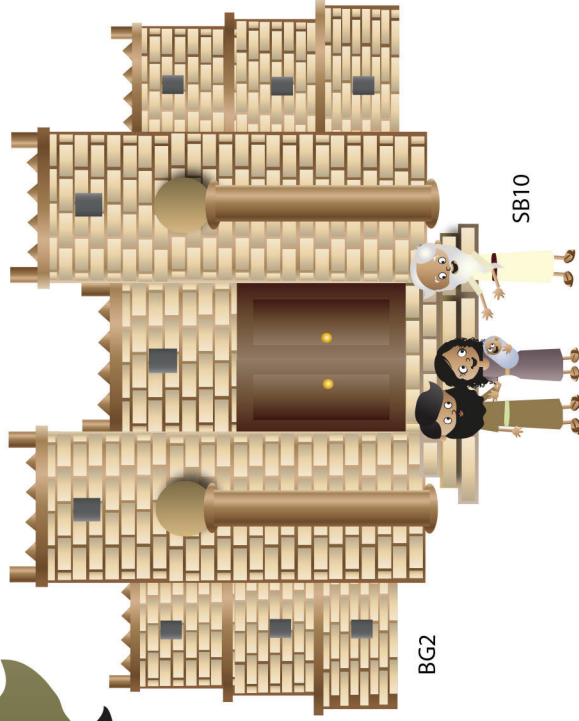

NOTE:

Some of the larger images are assembled from two or more pages. You can make these easier to fold by leaving a small gap in the lamination between the pieces. This allows you to fold the image along the gap.



leave slight gap here
to create a "hinge" for
easy folding



BGI Mountains
HSK 1 Story
Put on board ahead of time



SB13 Jesus in Heaven
HSK 1

SB2 Heart
HSK 1

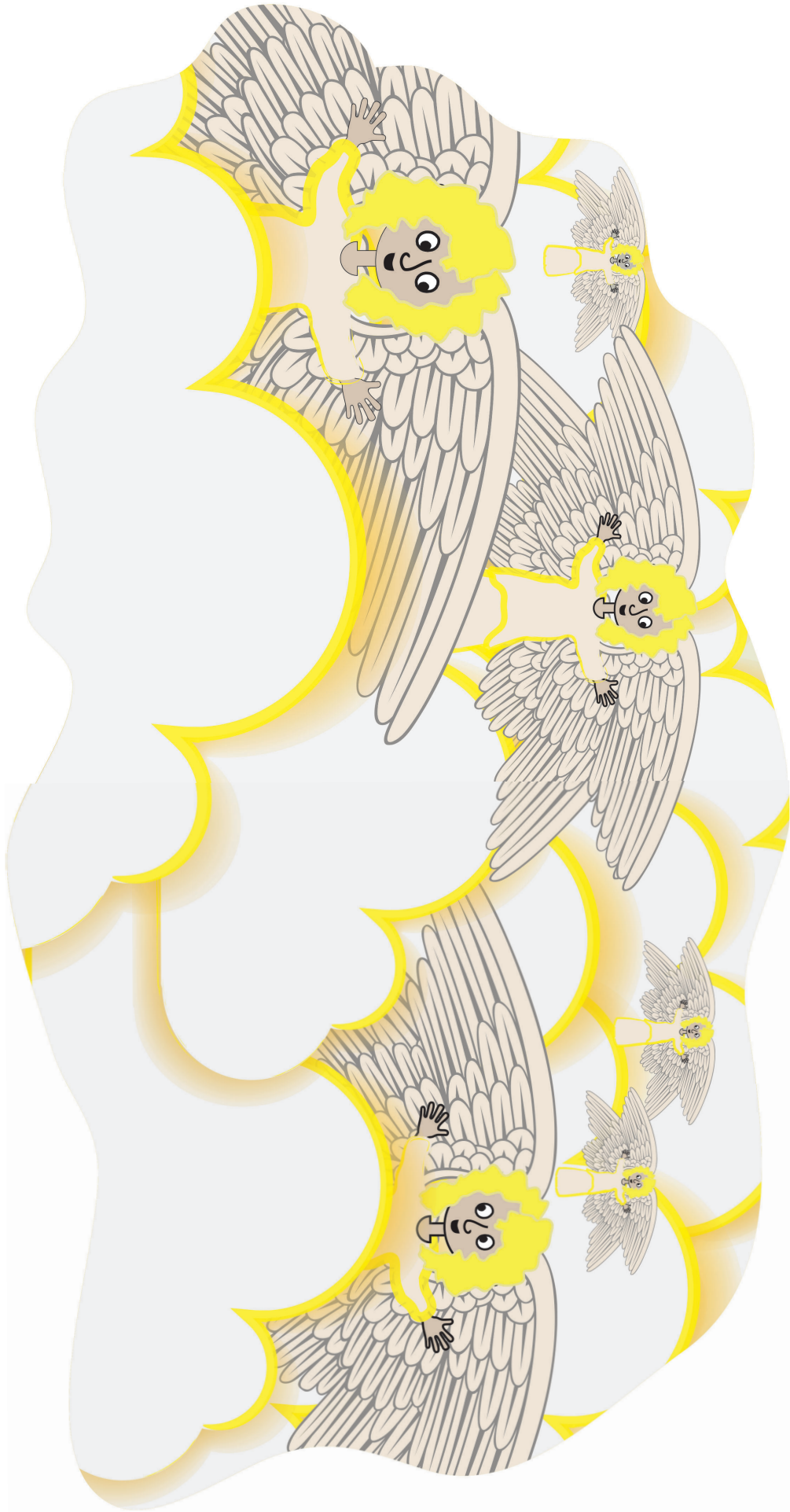

BG4 Heaven
HSK 1 Story
Put on board ahead of time

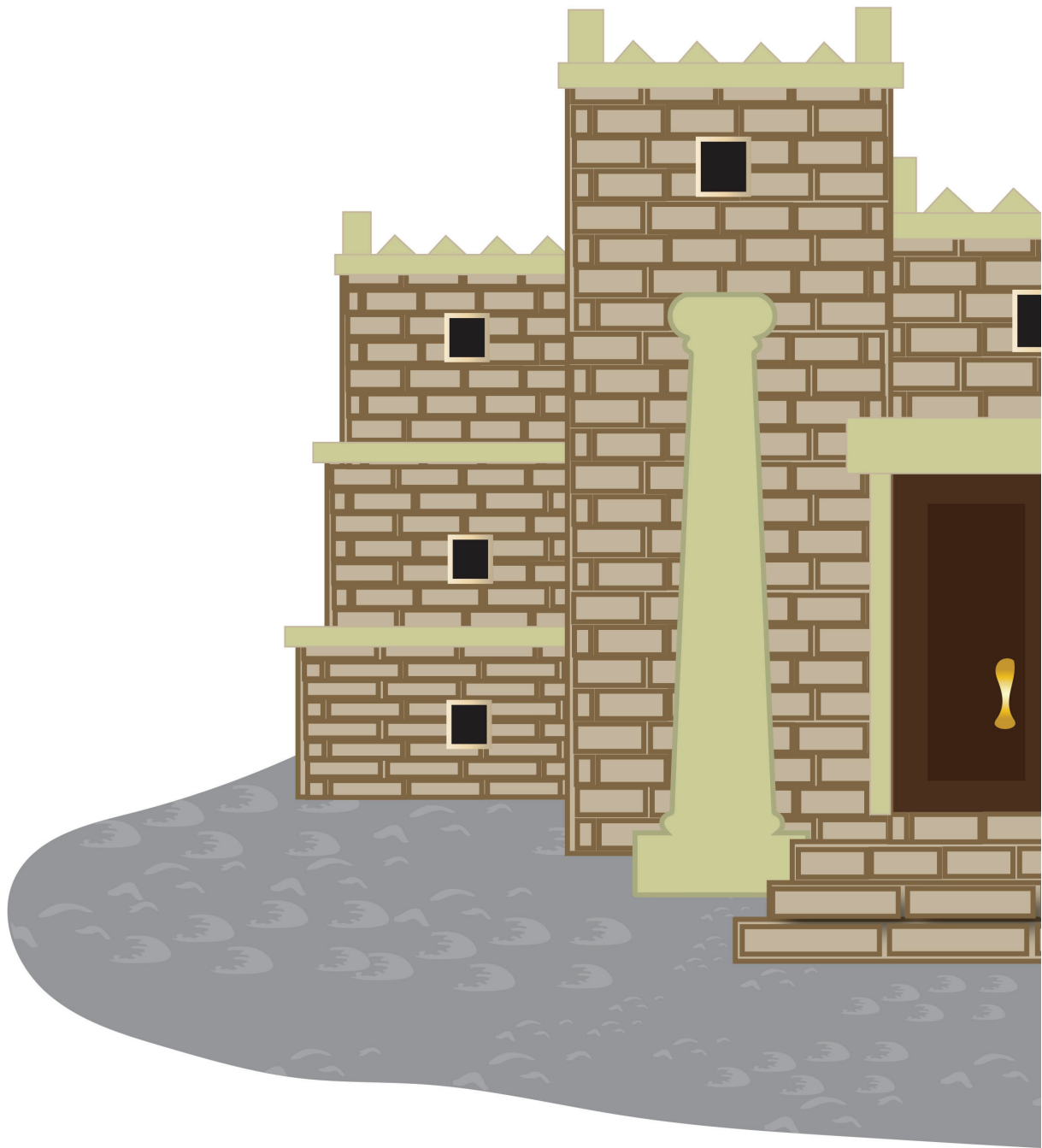

BG2 Temple, pt 1 of 2
HSK 1 Story
glue together, then laminate
Put on board ahead of time

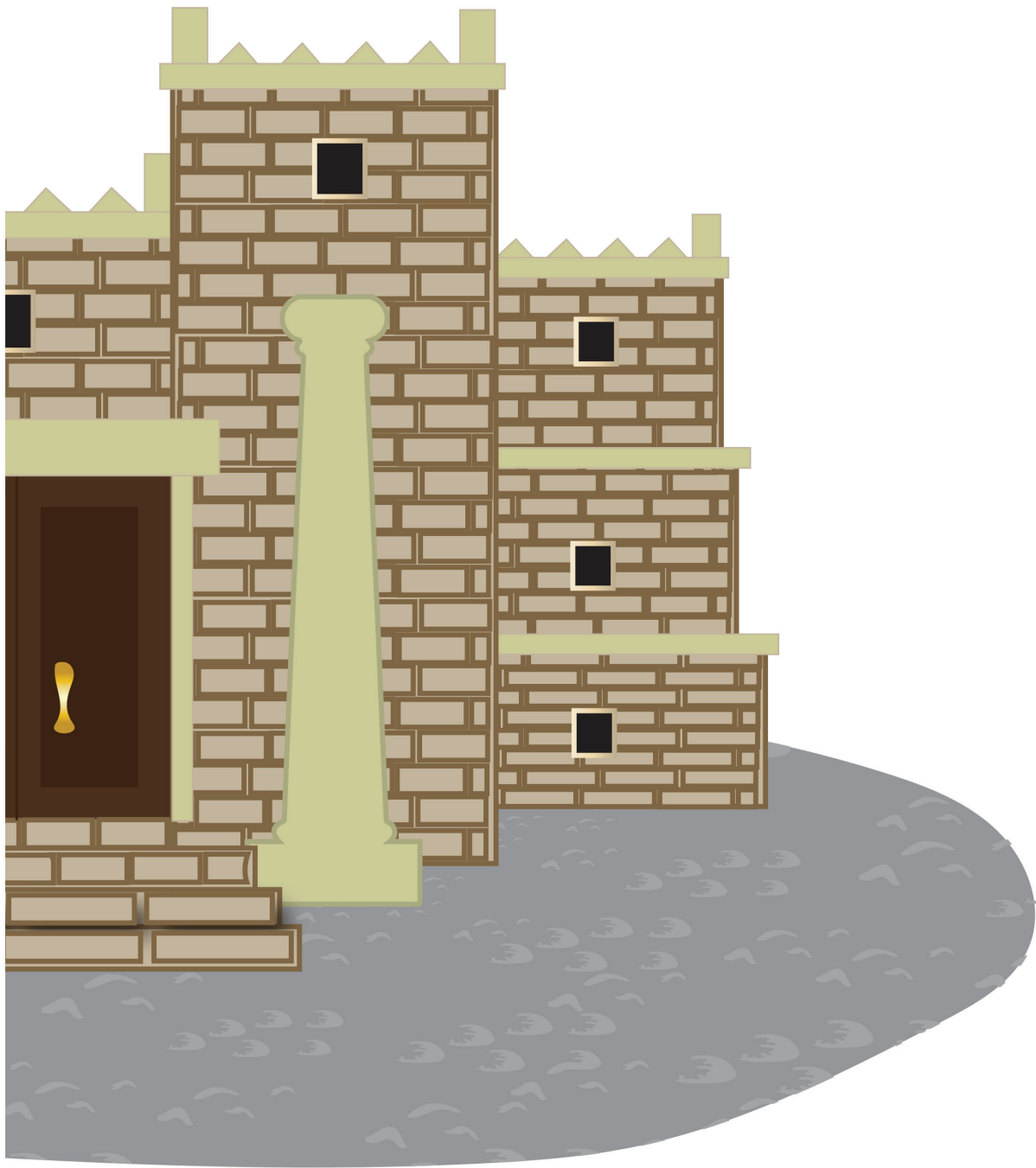

BG2 Temple, pt 2 of 2
HSK 1 Story
glue together, then laminate
Put on board ahead of time

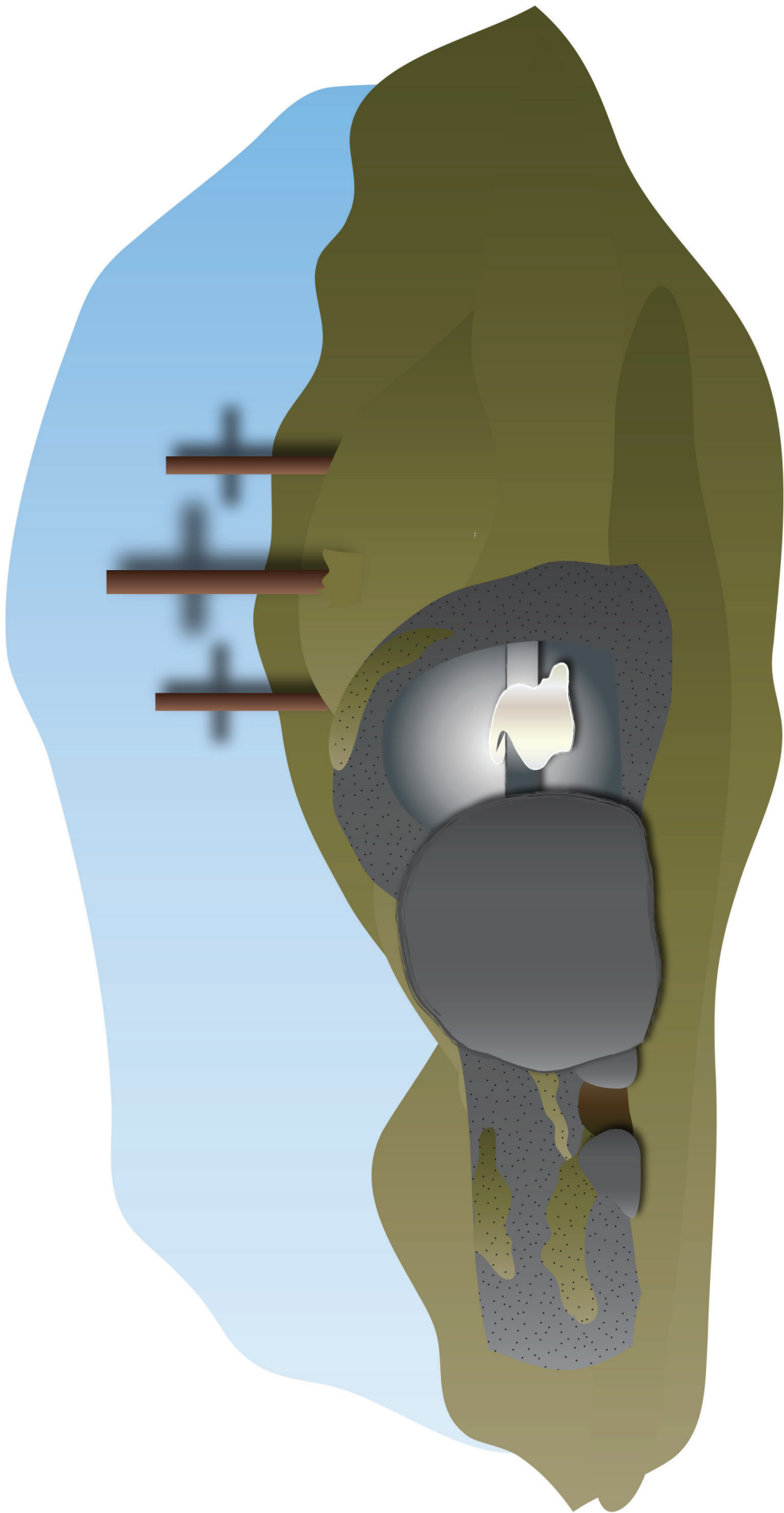

BG3 Cross/Tomb
HSK 1 Story
Put on board ahead of time

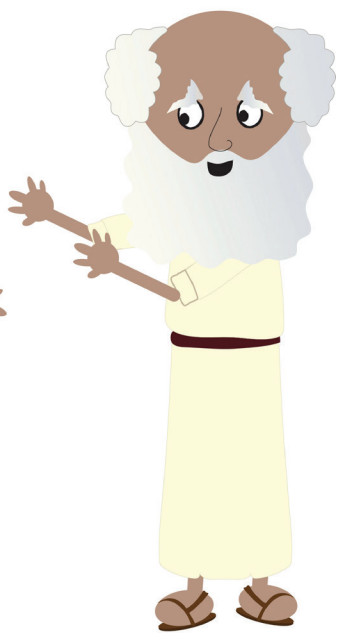

SBI Simeon
HSK 1

SB7 Simeon with
Mary, Joseph and Baby Jesus
HSK 1

SB10 Jesus Risen
HSK 1

SB12 Simeon in Heaven
HSK 1

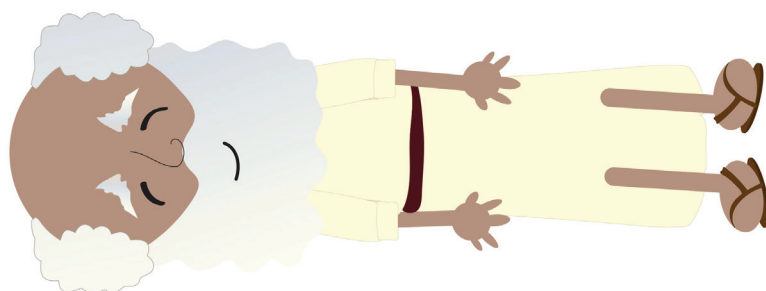
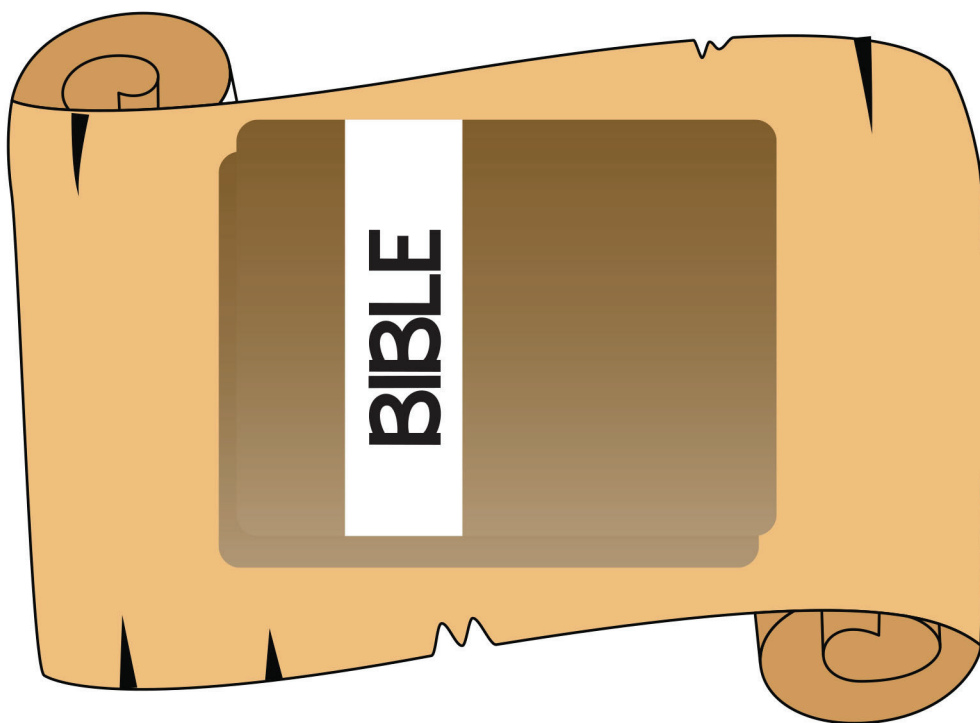
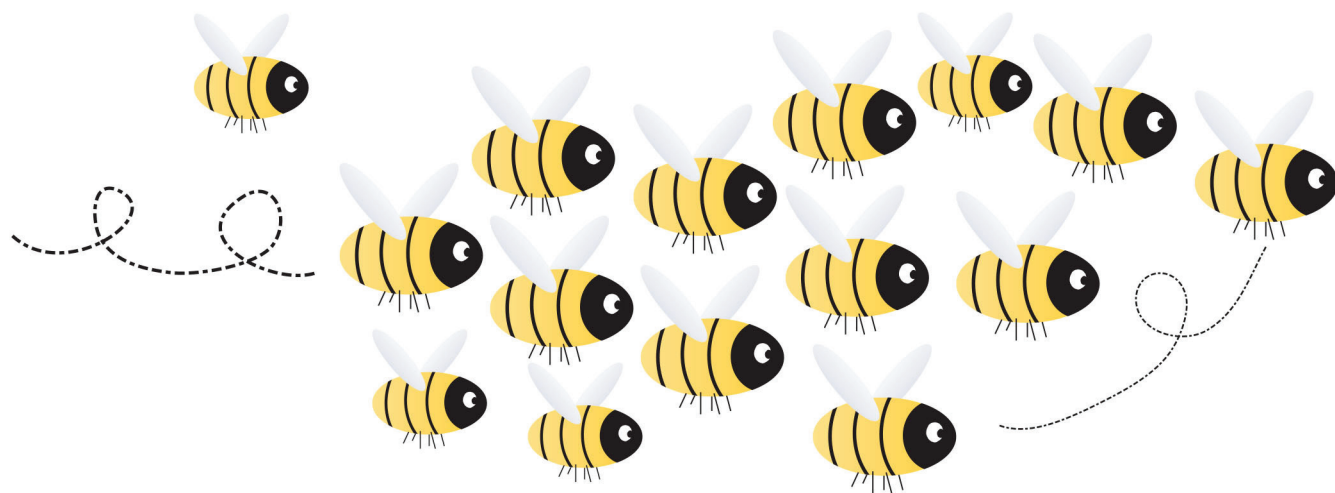

SB5 Buzzing Bees
HSK 1

SB6 The Bible, God's Word
HSK 1

SB11 Simeon Dead
HSK 1



SB3 Galloping Horses
HSK 1

SB4 Flying Birds
HSK 1

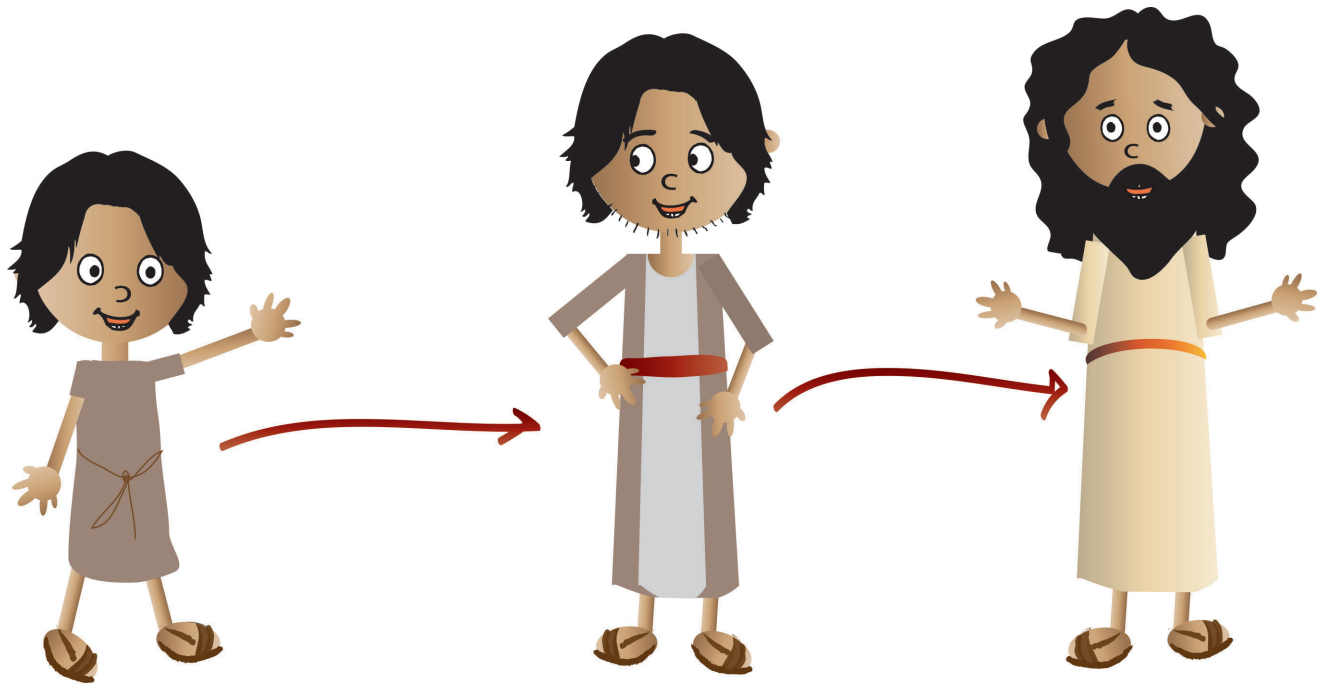
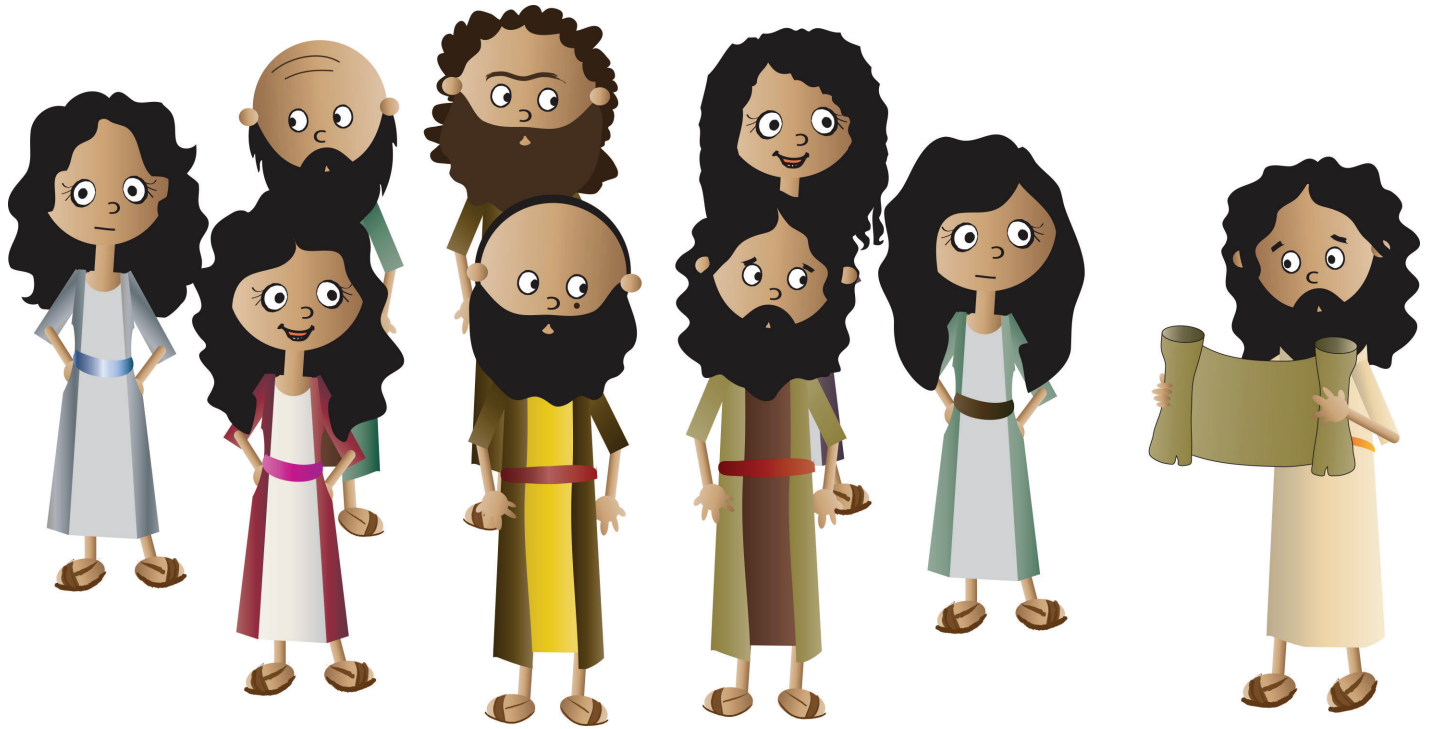

SB9 Jesus Teaching People
HSK 1

SB8 Jesus Growing Up
HSK 1

Hide 'n' Seek Kids

Other
Visual Aids



The Hide 'n' Seek Kids "Bible" Folder

This is a homemade folder that looks (kinda) like the cover of a Bible. You will use this to put the Bible verse, the Bible Story and storyboard pictures to help make the point that the truths you are teaching them come from the Bible.

Supplies

1 piece of 22" x 28" posterboard (white is fine. Green or brown is nice)

Glue

Stapler and staples or packing tape

The Bible Cover pictures (see online with resources for this unit or from the back of each Hide 'n' Seek Kids Visual Aids book.)

NOTE: The Bible Cover pictures included in the Hide 'n' Seek Kids Visual Aids books cannot be created larger than 8.5" x 11". That means that they will be under-sized for a Bible Folder of the dimensions you are making. However, you can go online to the Hide "n' Seek Kids curriculum and there is a pdf of a bigger version of these covers that will actually fit the size of this HSK "Bible" Folder.

Directions

1. Lay out poster board with long side along the bottom.
2. Fold in 2" on each side.
3. Take packing tape and tape the folded in 2" flaps to the main section of the posterboard, all the way down.
3. Fold up 8 1/2" on the bottom of the poster board.
4. Use packing tape to tape this flap in place, all the way down.
5. Take scissors and snip through the tape where the flap is attached to the folder. This will give you a bit more room in the folder.
6. Fold the poster board in the middle to make the center fold.
7. Cut out the Bible Cover Pictures. If possible, laminate these. They will last longer.
- 8.. Glue the two cover pieces to the outside of the folder.

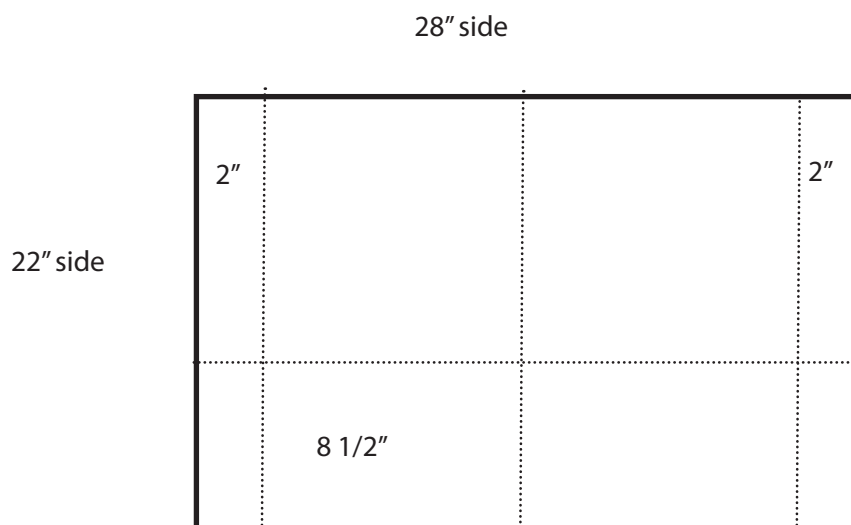

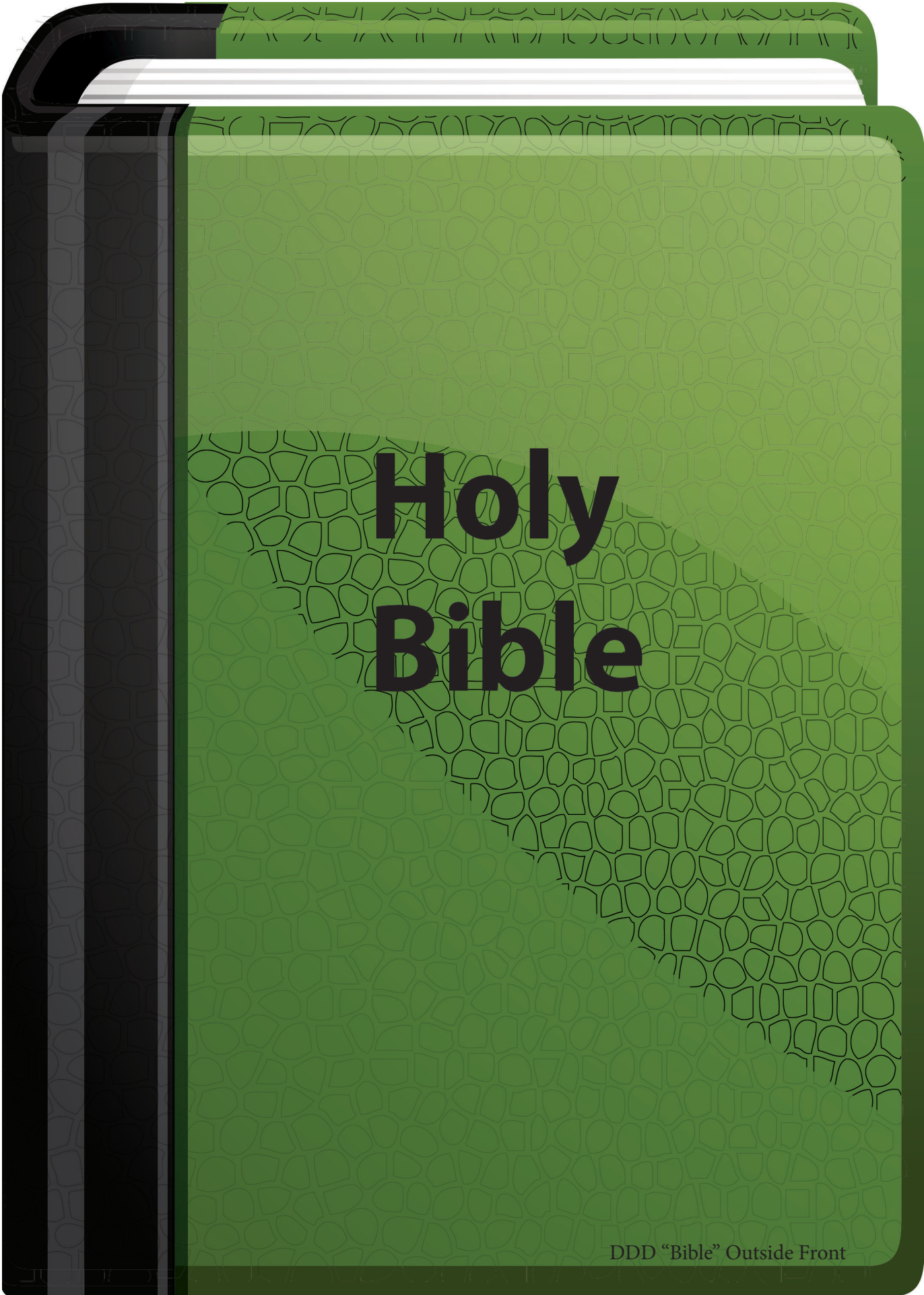

**Holy
Bible**

HSK "Bible" Outside Front



HSK "Bible" Outside Back

Making a Flannelgraph Storyboard

for use in story-telling and in playing the story review games

While you may decide to use sticky tac and stick your storyboard pictures to a white board, it is very easy to make a flannelgraph board. The advantage to the flannelgraph board is that the pictures stick very easily and there is no messing with the sticky-tac.

Supplies

Large Format Pictures Board: AT LEAST a 36" x 48" foamboard or corkboard (We actually use a far bigger canvas and attach it to the wall) A science project board with the two sides that fold out makes a good 36" x 48" board.

Small Format Pictures Board: AT LEAST a 24" x 36" (to 36" x 48)" board

Large piece of neutral-colored felt to cover your board with extra to overlap over to the back, if desired.

Glue gun and glue sticks

Directions

1. Center felt on front side of board. Turn over. Secure in place with glue.

Making Durable Storyboard Pictures

for use in story-telling and in playing the story review games

Whether you purchase the Hide 'n' Seek Kids storyboard pictures from Amazon or print them off the website (included in the Hide 'n' Seek Kids Visual Aids book), you will want to find some way to make them more durable. They are used not only as a part of telling the story, but are integral in the story review games. Here's how we make ours durable enough to be used over and over again.

Supplies

Hide 'n' Seek Kids Visual Aids book (purchased or downloaded)

White cardstock or printer paper (if downloading pictures)

Sticky-back velcro, circles or cut pieces; or sticky tac putty

Laminator or Self-laminating sheets

Sturdy Sheet Protectors, preferably the "Secure Top" kind, like offered by Avery

Flannelgraph pictures for the Bible stories found at www.praisefactory.org with each unit's resources.

Directions

1. Purchase from Amazon or download and print out the storyboard figures.

2. Cut out flannelgraph figures.

3. Laminate the figures.

Special tip: When laminating the big background pictures that are two (and sometimes even three or four) pieces put together, leave a small gap between the two pieces before laminating together. This small space acts like a hinge and allows you to fold up pictures without hurting them into a manilla envelope that fits 8.5" x 11" sheets of paper along with all of the smaller, regular-sized storyboard pictures.

4. If using a flannelgraph board: Stick a piece of sticky backed velcro (ROUGH SIDE) onto the back of each figure. If using sticky tack and whiteboard: simply stick a small amount of sticky tack on the back of a picture when using it. Remove and store sticky tack in airtight container.

Big Question Box/Briefcase

What You Want

The Big Question Briefcase is a briefcase or other container with these characteristics:

- Ideally, this should be around 17" x 12", but needs to be at least big enough to fit a 8 ½" x 11" sheets of paper inside it.
- Have various pockets to put these sheets in
- Is attractive or curious looking to preschoolers
- Not necessary, but extremely fun, if it has a combination lock

Finding a Briefcase:

You can certainly buy one new, but you always may find a used one at a thrift shop. Or, someone may have one they want to donate. We use one that stores valuables in it and is the 17" x 12" size. Very durable and has the lock feature that the kids love.

You also can move away from the briefcase idea and use a little trunk or other box for your substitute briefcase. Just change the name to the Big Question Box, if you use a box instead. A boot box or the cardboard box that 10 reams of copy paper comes in is a great size, if you are using a box.

If you use a box, but want a lock-like feature, that's easy to do. Simply cut "straps" out of felt or vinyl and glue in place to the top and bottom sides of the box on one side, with the top strap overlapping the bottom straps. Add velcro to the top and bottom pieces so that they meet and fasten. Make back "hinges" for the box with the felt/vinyl straps, too. Or, you can simply add a belt around the box that has to be unfastened before the box can be opened.

Here are some suggestions for decorating a box or even the outside of your briefcase to make it appealing.

Supplies

Your box/briefcase

Plain white contact paper or white cardstock

Colorful wrapping paper

Glitter glue

Markers

Sequins, fake jewels, buttons, rick rack, etc.

Other decorating supplies

Stickers

Glue

Clear packing tape

Directions

1. If you are using a box that has wording on it, you will first need to make plain surfaces for decorating and a hinge for the lid. Stick the white contact paper or white cardstock to each side of the box. On the other hand, you can also use colorful wrapping paper. Then, make a lid by sticking the clear packing tape along one long side of the box, attaching the lid to the box.

2. Use the craft decorating supplies to decorate the box. If desired, you can put a big question mark on top of the box, but remember that you are working with two and three year olds: the question mark symbol is not very meaningful to them yet.