

DEEP DOWN DETECTIVES

Fundamentals:

Unit 3, Bible Truth 3



What Is the Gospel?

It's Salvation through Faith

in Jesus Christ...

God Sent Jesus to Pay

for the Sins of God's People!

Unit 3: The Good News of God, the Gospel

UNIT OVERVIEW

Gospel means “good news.” In the Bible, the gospel is the good news that God sent His Son Jesus to save sinners like you and me from the punishment we deserve for our sins. That salvation is ours when we turn from our sins and trust in Jesus as our own Savior. Now that is good news indeed!

In this unit we will learn four ways the gospel is such good news.

UNIT BIBLE VERSE: John 3:16

“For God so loved the world that he gave his one and only Son, that whoever believes in him shall not perish but have eternal life.”

BIG QUESTION UNDER INVESTIGATION: What Is the Gospel?

ANSWER: It’s Salvation through Faith in Jesus Christ!

OPTIONAL Big Question 3 INTRODUCTION LESSON (Use Hide ‘n’ Seek Kids Unit 3 Material)

Story: The Case of the Stranger’s Very Good News *Acts 8:1-8*

Bible Verse: John 3:16

BIBLE TRUTH 1: God Made Us and We Should Obey Him (3 Lessons Available)

Story: The Case of the God Who Was Different *Acts 17:16-33*

Bible Verse: Psalm 100:1-4

BIBLE TRUTH 2: We Have All Disobeyed God and Deserve His Punishment (3 Lessons Available)

Story: The Case of the Squabbling Brothers and Sisters *Romans*

Bible Verse: Ecclesiastes 7:20,29

➔ BIBLE TRUTH 3: God Sent Jesus to Pay for the Sins of God’s People (3 Lessons Available)

Story: The Case of the Savior, from Start to Finish *Genesis, The Gospels*

Bible Verse: Psalm 119:18,72-73

BIBLE TRUTH 4: God Saves All Who Repent of Their Sins and Trust in Jesus as Their Savior

(3 Lessons Available)

Story: The Case of Cruddy Crete *Titus*

Bible Verse: Mark 1:15

Deep Down Detectives NIV Songs 3 Track Numbers

This is a listing of all songs mentioned in the unit curriculum. You may or may not choose to use all of the songs. They are listed in easy-reference order--NOT in the order used in the curriculum.

You may choose to simply burn a CD/load them onto an mp3 device in this order. Or, you may want to do what we do: choose the songs we want to use and create a play list of them in that order. Then, we burn a CD/upload the play list onto an mp3 device. A teacher only has to click forward to the next song, instead of hunting for the right track. The track number have been included as part of the title of each song, so teachers will still have a reference to the track number listed in the curriculum (same as those listed below), even if you change the order on your customized play list.

SONGS USED EVERY UNIT OF THE CURRICULUM

- 1 The Classroom Song v.1
- 2 The Classroom Song v.2
- 3 The Classroom Song v.3
- 4 The Classroom Song v.4
- 5 Deep Down Detectives Theme Song
- 6 The Classroom Rules Song
- 7 Let's Pray Song
- 8 The Big Question Box Song
- 9 The Bible Chant Song
- 10 ACTS Prayer Song (Short Version)
- 11 ACTS Prayer Song (Full Version)

Why the Extra Songs?

Deep Down Detectives is a curriculum used by a wide age-span of kids. Sometimes one of the other songs is a better fit for your kids. Or, you may simply want to teach them more songs on the same Bible Truth. Use as many or as few as you want.

UNIT 3: GOD'S GOOD NEWS, THE GOSPEL

- 12 Big Q & A 3 Song
- 13 Big Question 3 Song: What's the Gospel?
- 14 Big Question 3 Bible Verse Song: For God So Loved the World John 3:16
- 15 *Extra Big Question 3 Bible Verse Song: For God So Loved the World John 3:16 (version 2)*
- 16 *Extra Big Question 3 Bible Verse Song: For God So Loved the World John 3:16 (version 3)*
- 17 Big Question 3 Hymn: And Can It Be, v.1 Refrain
- 18 Big Question 3 Praise Song: I Have Decided to Follow Jesus

What Is the Gospel?

Salvation through Faith in Christ...

Bible Truth 1: God Made Us and We Should Obey Him

- 19 Bible Verse: Shout for Joy Psalm 100:1,2

Bible Truth 2: We Have All Disobeyed God and Deserve His Punishment

- 20 Bible Verse: There Is Not a Righteous Man Ecclesiastes 7:20,29

Bible Truth 3: God Sent Jesus to Pay for the Sins of God's People!

- 21 Bible Verse: He Was Pierced Isaiah 53:5

Bible Truth 4: God Saves All Who Repent of Their Sins and Trust in Jesus

- 22 Bible Verse: The Time Has Come Mark 1:15
- 23 *Extra Bible Verse: Help Us, O God, Our Savior Psalm 79:9*

Unit 3: The Good News of God, the Gospel

Unit Big Question (and Answer): What Is the Gospel? It's Salvation through Faith in Jesus Christ!

Unit Bible Verse: "For God so loved the world that he gave his one and only Son, that whoever believes in him shall not perish but have eternal life." John 3:16

Bible Truth 3 Concept: Salvation through Faith in Jesus Christ...God Sent Jesus to Pay for the Sins of God's People!

What a mess we have made in God's good world! God is our good Maker and King, yet we have all chosen to disobey Him. Because God is good, He hates sin and He is right to punish our sins. We certainly deserve it! The punishment for sins is death--being separated from God and all His goodness forever. How sad!

But God is not only good. He is also very merciful. He treats us better than we deserve. That's why God, Himself, made a way for us to be forgiven our sins and to become His people. God sent His own, dear Son, Jesus to live the perfect life of love and obedience that we should live, but never do. On the cross, Jesus offered His perfect life to God as the full payment for sin for all who turn away from their sins and trust in Him as their Savior. Jesus suffered and died in our place. Then on the third day, Jesus rose up from the dead, showing that He had really beaten sin and death! Jesus can be our Savior, too, when we turn away from our sins and trust in Him as our Savior.

Bible Truth 3 Bible Verse: Isaiah 53:5-6

"But he was pierced for our transgressions, he was crushed for our iniquities; the punishment that brought us peace was upon him, and by his wounds we are healed. We all, like sheep, have gone astray, each of us has turned to his own way; and the LORD has laid on him the iniquity of us all."

Learn a Little: "The punishment that brought us peace was upon him."

Meaning

God is our good King and Creator and we should love and obey Him. But the sad news is that we all choose to disobey Him...and we all deserve His punishment.

Yes, we deserve His punishment, but God has loved us so much that He sent His Son, Jesus to take the punishment that we deserve instead. Jesus lived a perfect life and chose to give it up to pay for our sins. On the cross He suffered and died. He was pierced with nails in His hands and feet. He was pierced in His side with a sword. He took all of the punishment that we deserve from God for our sins so that we could be forgiven. Jesus made the way for us to have peace with God by suffering in our place.

Who did Jesus do this for? It is God's free gift to all who put their trust in Jesus as their Savior and choose to live for Him. This gift can be for you, too! Ask God to help you. He loves to answer this prayer!

Bible Truth 3 ACTS Prayer

- A** God, we praise You for being the good Creator and King of the world.
- C** God, we confess rebelling against You and Your good ways. Too many times we choose to live life our own way instead of Yours. We need a Savior!
- T** Thank You for being our good Creator and King. Thank You for making everything in the world for Your good purposes. Thank You for being so merciful to us! Thank You for offering us salvation through Jesus, when we repent of our sins and trust Jesus as our Savior.
- S** God, work in our hearts, helping us to turn away from disobeying You. Help us to trust in Jesus as our Savior. Help us to joyfully obey You, as is best for us and brings You glory. In Jesus' name we pray. Ame

Bible Truth 3 Story**The Case of the Savior, from Start to Finish**

Genesis; The Gospels

Songs Used in Bible Truth 3

Big Question 3 Bible Verse Song: For God So Loved the World John 3:16

Extra Big Question 3 Bible Verse Song: For God So Loved the World John 3:16 (version 2)

Extra Big Question 3 Bible Verse Song: For God So Loved the World John 3:16 (version 3)

Big Question 3 Hymn: And Can It Be, v.1 Refrain

Big Question 3 Praise Song: I Have Decided to Follow Jesus

Bible Truth 3 Bible Verse Song: He Was Pierced Isaiah 53:5

The Case of the Savior, from Start to Finish*Genesis, The Gospels***Story-telling Tips**

Ahead of time:

1. Read the Bible verses and story. Pray!
2. Practice telling story with expression. Look for words that might be new to your children. Plan to explain the meaning of them to the children. The numbers in the story correspond to elements of the picture. Practice pointing to the pictures as you read the story. Shorten the story, if necessary, for your child/group of children.
3. If desired, choose a listening assignment for the children (listed below). Listening with a purpose helps the children keep focused and glean more from the story. The three, different assignments allow you to re-tell the story three times with fresh purpose. Answers to the listening assignments are found at the end of the story.

During your presentation:

1. If you are telling the story to a group of children, maintain as much eye contact as possible as you tell the story. Tell the story with enthusiasm and expression. Take time to show each story scene to the children as you tell it. Use the cue numbers in the story to highlight corresponding parts of the picture as you tell the story.
2. The Clue Catcher question at the bottom of each scene helps the children keep engaged with the story.
3. Include the children in your story with a few questions about what they think will happen or words/concepts that might be new to them.
4. Watch the kids for signs that their attention span has been reached. Shorten, if necessary.
5. At end of the story, repeat the listening assignment question and ask for answers. Close in prayer.

INTRODUCTION/ LISTENING ASSIGNMENTS (Optional)

“Our story is called: The Case of the Savior, from Start to Finish. Here is your listening assignment... “
(optional)

Detective Dan’s Lesson #1 Listening Assignment:**I need to know:**

1. Who was the Savior?
2. When did the promise of a Savior start? When did it finish?

Detective Dan’s Lesson #2 Listening Assignment:**Our Bible Verse is Isaiah 53:5-6**

“But he was pierced for our transgressions, he was crushed for our iniquities; the punishment that brought us peace was upon him, and by his wounds we are healed. We all, like sheep, have gone astray, each of us has turned to his own way; and the LORD has laid on him the iniquity of us all.”

I need to know:

Transgressions and iniquities are other words for sin.

1. Whose transgressions and iniquities deserved God’s punishment in our story?
2. Who came to take God’s punishment for them?

Detective Dan’s Lesson #3 Listening Assignment:

I found six clues, but two of them are NOT in the story.

They are: a tree; a lamp; a garden; a cave grave; a bed; and, a man named Abraham.

Hold each of them up for the children to see as you identify them.

I need to know:

1. Which four belong in the story and which two don’t?
2. Which one did the Savior use to prove He had won? What do we thank Him for beating?

Read the assignment questions, THEN SAY,

“Ok, Deep Down Detectives! Put on your best listening ears and see if you can hear the answers to Detective Dan’s questions. When I finish telling the story, we will see if we can answer all the questions.”

*Read the Bible Truth story, answer questions, present the gospel and lead in prayer.
Answers to questions; the gospel; and, ACTS prayer are included with the story text.*



Story Scene 1

Back in the very beginning,  God created our world.

Heavens and earth.
Sky and seas,
Mountains and valleys,
Flowers and trees,
Birds and fish and animals, too,
And best of all, God made people,
Like me and you.

And it was all good. VERY good.

But why were **PEOPLE** the best of all that God created, back in the very beginning? It's because He created people with something that no other earth creature had: a  living spirit that could know and love Him. We could have a special closeness to God that no one else could enjoy!

I'm sure it's very fine to be a fast horse galloping across a grassy field; or, a proud eagle soaring on the wind high up in the sky. I'm sure it would be marvelous to twist and spin like a dolphin in the ocean. And don't we all enjoy looking up at the beautiful stars at night or gazing at tall, snowy mountains in the distance?

But **NONE** of this is **ANYTHING** as great as knowing God and being close to Him. That is the **BEST** thing anyone can ever enjoy. And that's why this spirit inside people makes us so very special, indeed!



Clue Catchers: Can you find Adam and Eve, the first people, in this picture?

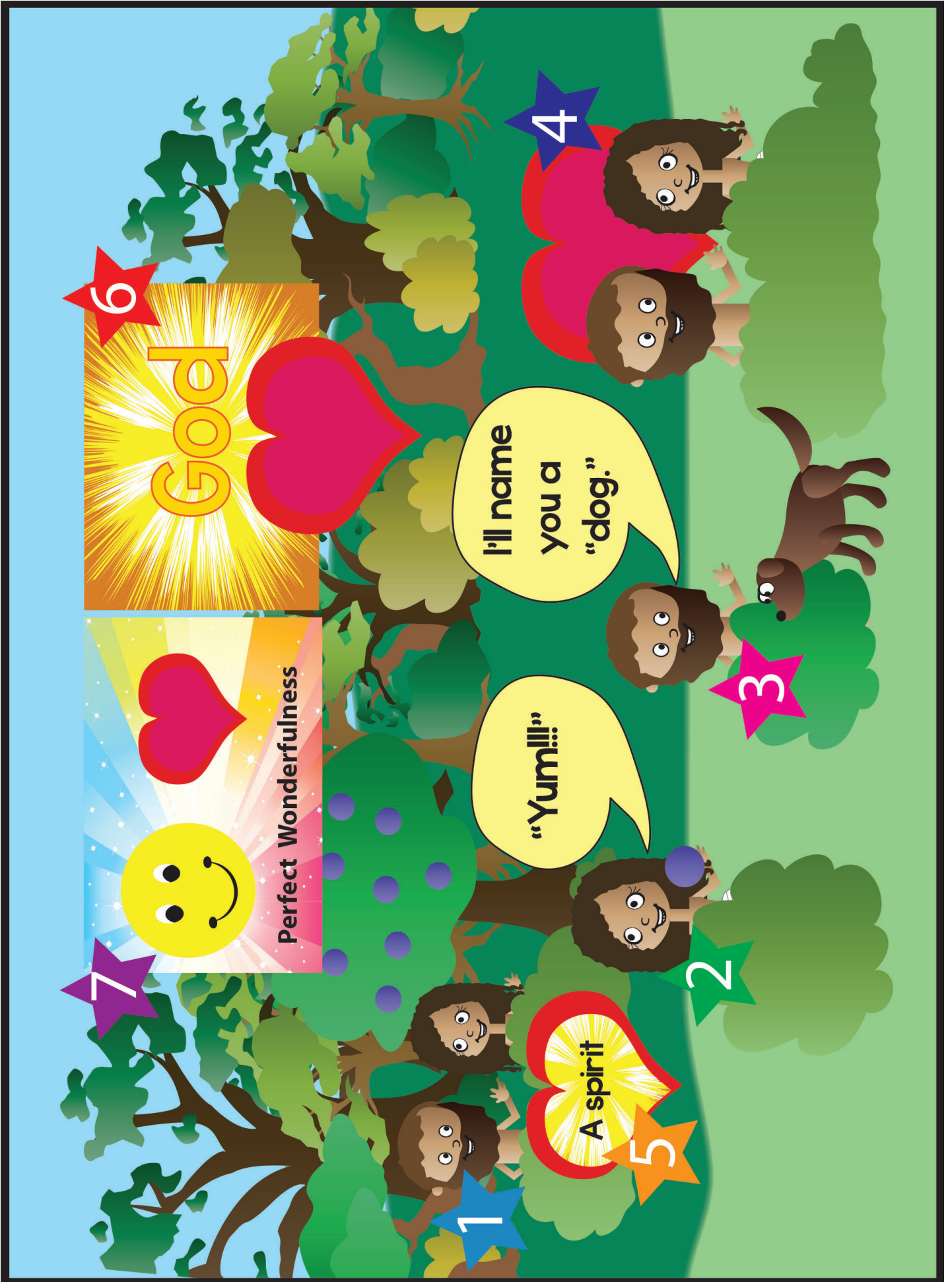

Perfect Wonderfulness

God

"Yum!!!"

I'll name you a "dog."

A spirit

Story Scene 2

God named the first man and woman, **1** Adam and Eve. He gave them a beautiful garden home with everything they needed— **2** perfect food to eat, **3** perfect jobs to do, and **4** perfect friendship to enjoy with each other.

But the best thing about life in the Garden, wasn't anything that Adam and Eve could put in their mouths, or do with their hands or even enjoy with each other. The best thing that Adam and Eve had in that Garden was something that they couldn't even see or touch. And it all had to do with that **5** spirit God gave them.

Can you guess what that best thing was?

The best thing about life in the Garden was **6** the very special closeness that they had with God.

What was that very special closeness like? I like to call it **7** "Perfect Wonderfulness.. "It was "Perfect", because there was no sin in Adam and Eve's hearts that blocked it. And it was "Wonderfulness," because it was far better than ANYTHING we can imagine.

Doesn't the life Adam and Eve had with God sound amazing? Perfect Wonderfulness, lasting forever!

"Perfect Wonderfulness" -- knowing, loving, trusting and obeying God completely. And God sharing His love and showing Himself to them in a way deeper and better than any of us has ever known. Yes, life with God in the Garden was "Perfect Wonderfulness." And what made it even MORE wonderful was that it could go on this way forever and ever.

Doesn't the life Adam and Eve had with God sound amazing? Perfect Wonderfulness, lasting forever!



Clue Catchers: Can you point to the picture of Perfect Wonderfulness?



Story Scene 3

But the “Perfect Wonderfulness” did NOT last forever.

1 **Satan, God’s enemy, came into the Garden. He tempted Adam and Eve to doubt God and His goodness. His plan worked. 2 Right there, in the middle of that beautiful Garden of love, Adam and Eve stopped trusting God and chose to rebel against Him instead.**

What would God do? Well, there was only one thing that He could do. You see, God is GOOD. 3 He is HOLY. He hates sin. It is BAD. So He did what He must do— He punished Adam and Eve for their disobeying.

4 **Life in God’s perfect world was broken. Now there would be sin and sadness, sickness and death. Life in the Garden was broken, too. Adam and Eve lost their perfect food and perfect jobs and perfect friendship with each other. Worst of all, 5 they lost their Perfect Wonderfulness, their very special closeness with God that would have gone on forever and ever.**

Oh, what a lot Adam and Eve lost on that sad, sad day!

But there was something that Adam and Eve did NOT lose on that day.

Can you guess what it was?

They did NOT lose God’s love.



Clue Catchers: Can you find Adam and Eve disobeying God?

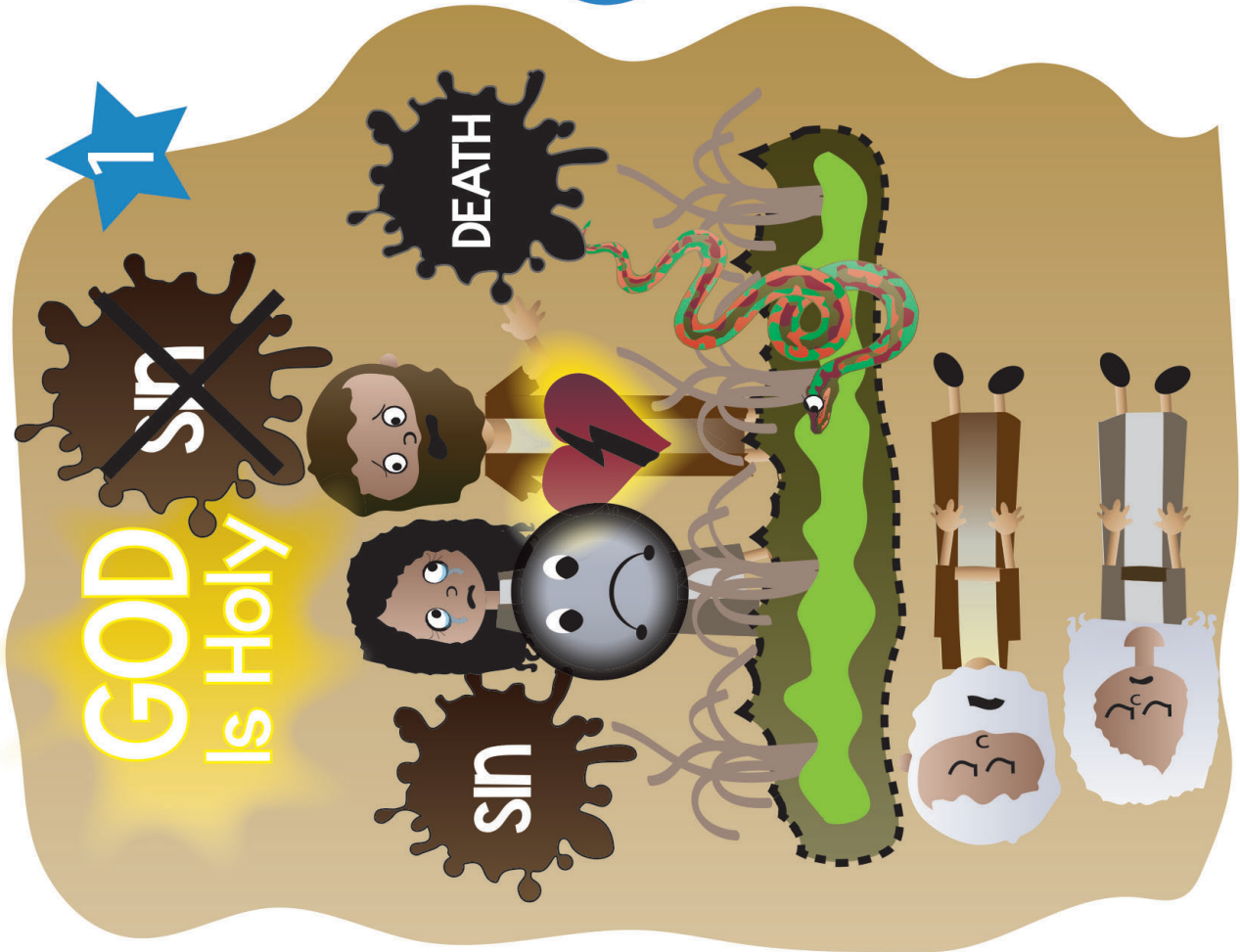

Story Scene 4

God, in His great love and mercy was not finished with them or His world. He had always known what would happen. And He had always planned for it. 🌟 He would NOT lose His people to sin and death and Satan's plans. He was holy and He hated sin, but He would SAVE His people from their sins. 🌟 He, Himself, would do it.

So on that very day, God gave Adam and Eve a promise. He would send 🌟 a Savior to 🌟 crush the enemy. He would win back the Perfect Wonderfulness for them. He would win back the Forever Life with Him that He had created them to enjoy.

Yes, He would win it all back, through the Savior He would send. We know His name, don't we?

Can you tell me the Savior's name?

The Savior would be Jesus, God's own Son.



Clue Catchers: Can you find the picture of sad things that can into the world when Adam and Eve disobeyed God?

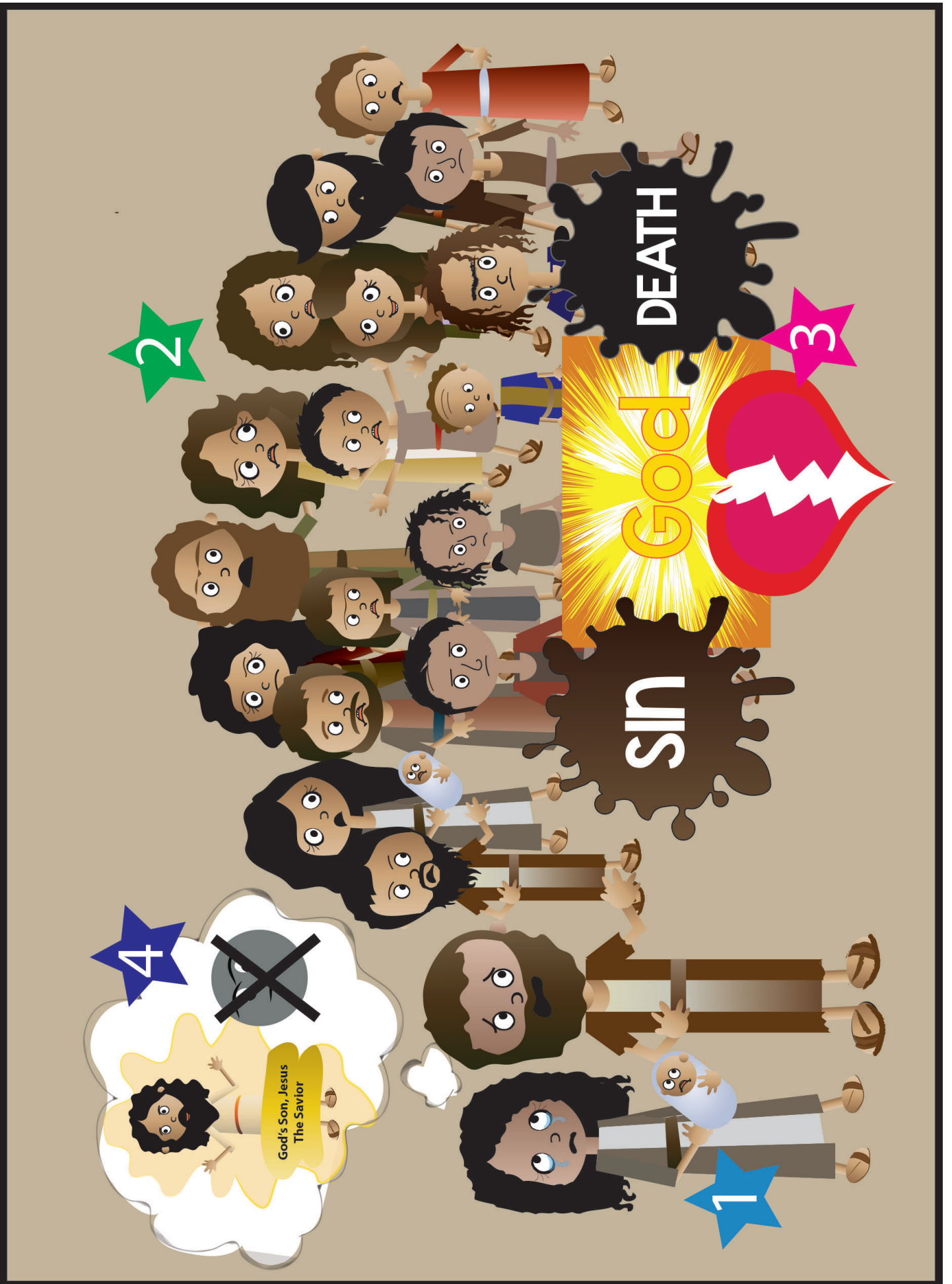

Story Scene 5

1 Adam and Eve had a family. 2 Their children had children, too. They were just like Adam and Eve. They had two eyes, two ears, two legs, and two arms. One head with one nose and one mouth. They even had that special heart made to know and love God.

But sadly, 3 their hearts were broken with sin, just like Adam and Eve's. They ALL chose to disobey God and they ALL deserved His punishment. How sad!

But there was good news, too. Though they all disobeyed God and their hearts were broken with sin, 4 some remembered God's promise to crush their enemy. They trusted in God and looked forward in faith to the day when the Savior would come.

Can you tell me the Savior's name?

The Savior would be Jesus, God's own Son.



Clue Catchers: Can you find the Savior God promised to send?



Story Scene 6

God's plan to send a Savior began to unfold. God chose **1** Abraham and his family to be the ones to prepare the world for the Savior.

He gave them **2** a special land to live in and **3** His laws to live by. He gave them His special promises, too.

God told them that all people would be blessed through someone who would be born into their family one day. **4** That someone would be the Savior.

Can you tell me the Savior's name?

The Savior would be Jesus, God's own Son.



Clue Catchers: Can you find the picture of Abraham in the special land God gave him and his family?

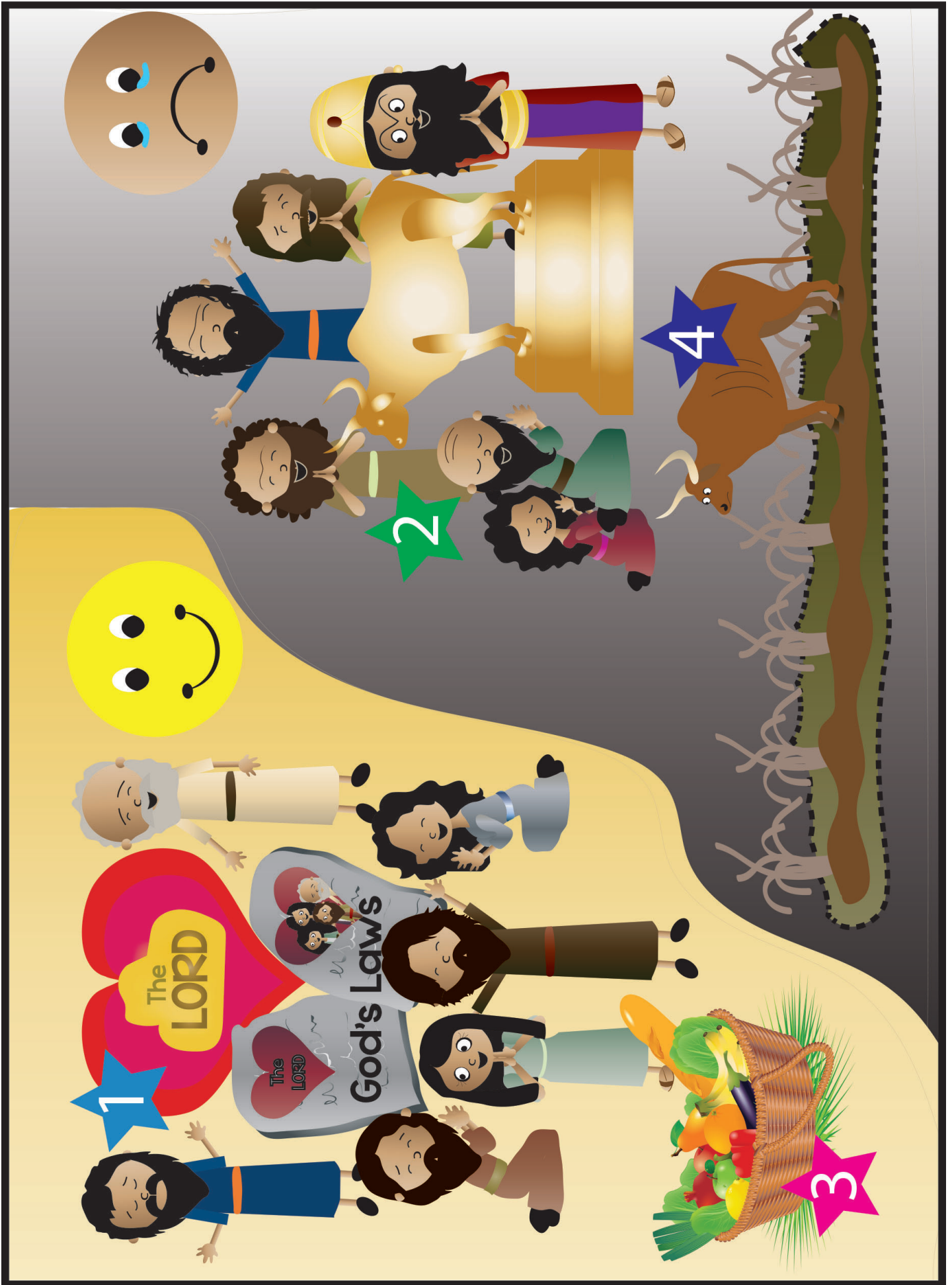

Story Scene 7

Many years passed. Abraham's family grew into thousands and thousands and thousands of people. A whole nation!

Sometimes,  they obeyed God, but many times  they did not. They  enjoyed God's great blessings when they obeyed. They  felt His loving discipline when they did not.



Clue Catchers: Can you find a picture of some of the good things God blessed Abraham's family with when they loved and obeyed Him?



1

2

3

God's Son, Jesus
The Savior

God's Word,
The Bible

Story Scene 8

When they kept refusing to obey, God's loving discipline became more painful. How God loved His people! So He gave them what they needed to turn back to Him. He  sent them far away from their home to work for their enemies.

They were so sad. They missed the good home and the good life He had given them. At last, their hearts changed. They were sorry they had disobeyed God. They wanted to turn back to Him.

God sent them good news: one day He would  bring them back home. And one day,  He would send a Savior.

Can you tell me the Savior's name?

The Savior would be Jesus, God's own Son.



Clue Catchers: Can you find the people sent away from their home and having to work for their enemies?

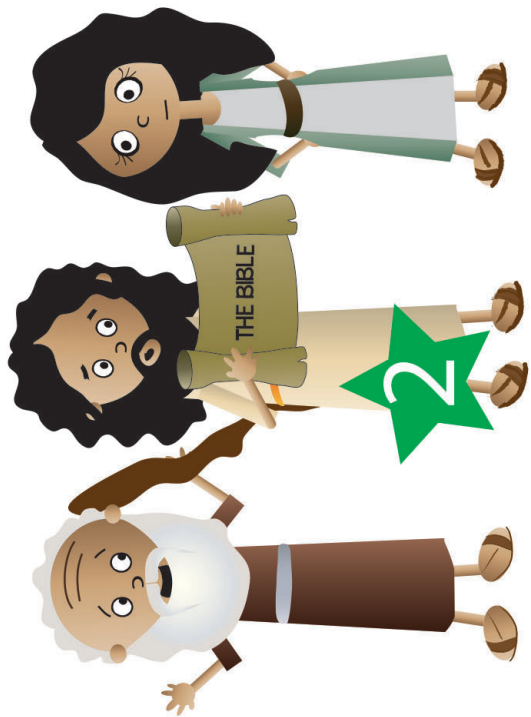
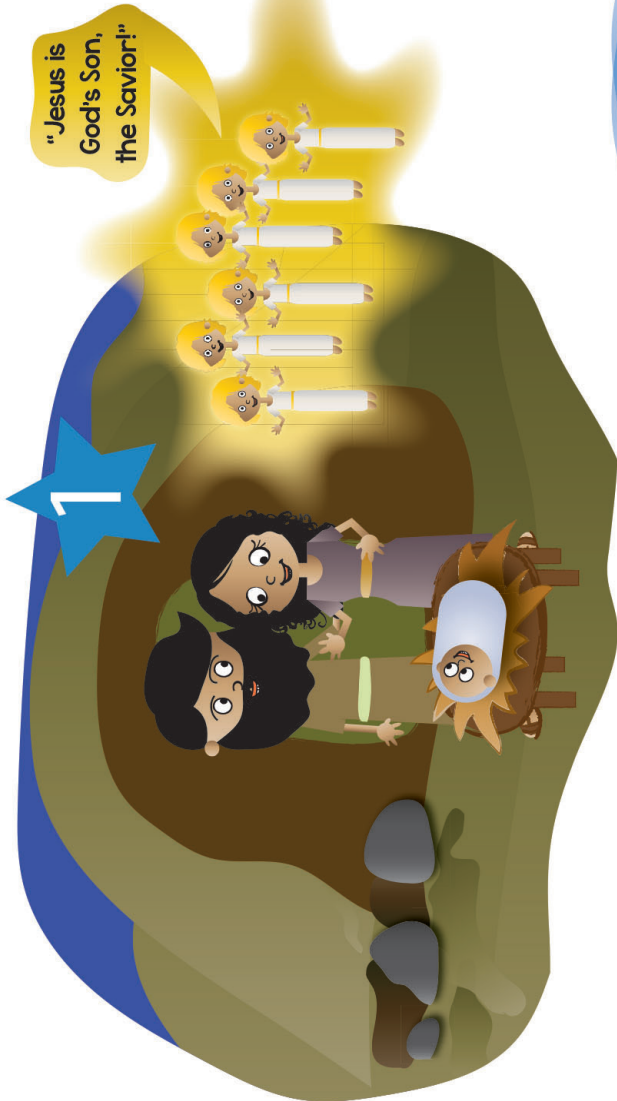

Story Scene 9

God kept His promises. He brought Abraham's family back home. Then, at just the right time, He sent the Savior. **1** He was born in Bethlehem--Jesus, God's own Son.

Jesus grew up. He **2** taught about God and did many amazing things. **3** He lived a perfect life—the life that Adam and Eve and all of us were supposed to live, but never did. He showed that He was God's Son, the Savior.

But Jesus didn't just come to show us that He was the Savior. He came to BE the Savior. He would make the way for us to have special closeness with God again. He would pay for our sins so that through Him we could once more enjoy Perfect Wonderfulness with God forever.

But, oh, what a terrible way it must all happen! Sin couldn't be paid for **4** with money. Sin even couldn't be paid for by Jesus just LIVING a perfect life in our place.

109

No, sin could only be paid for with by Jesus living a perfect life, and then Him GIVING IT UP for us. He had to take our punishment. He had to die the death that we deserved! That was the only way! So that's what Jesus did. He **5** suffered and died on the cross as the perfect sacrifice for our sins. He was our substitute. He was our payment!

How Jesus hurt that day as He suffered and died for us! How much God loved us that He would pay for our sins, Himself, through His Son Jesus! As Jesus died on the cross, His last words were, "It is finished." But what was finished? What it just His life was finished? Or could it be something more? *What do you think Jesus finished?*

Later that day, some men took Jesus' body to a cave grave in a garden. That looked like the end. But was it?



Clue Catchers: Can you find Jesus giving up His life on the cross to be our Savior?



God

Perfect Wonderfulness

Home with God forever!

Our Perfect Savior

Holy Spirit

2

1

3

Story Scene 10

(No, it was not! What people had lost in their beautiful Garden long ago, Jesus was about to prove that He had won back in this garden.

On Day One and Two, Jesus' body stayed in that cave grave, but then on Day Three,
 Jesus rose up from the dead in victory.

He was alive! Jesus had really beaten sin and death! That's what He had finished that day He suffered and died on the cross. All those sins paid for. The way back to Perfect Wonderfulness with God forever was made!

Now, all who turn away from their sins and trust in Jesus as their Savior can  enjoy a bit of special closeness with God in their hearts now by God's Holy Spirit.

And one day, when they die, they  will go to enjoy full, Perfect Wonderfulness with God forever. Perfect Wonderfulness. Perfect Forever. All of that is ours, all because the Savior came, and that Savior was God's Son, Jesus. Thank You, Jesus!



Clue Catchers: Can you find God's people living happily with God in heaven?

Cracking the Case: (story wrap-up for Listening Assignments)

It's time to see how we did with our Listening Assignment.

Detective Dan's Lesson 1 Listening Assignment:

1. Who was the Savior? God's Son, Jesus.
2. When did the promise of a Savior start? When did it finish? It started back in the beginning when Adam and Eve disobeyed God. It finished when Jesus died on the cross for the sins of God's people and rose from the dead in victory.

For You and Me:

The promise of the Savior wasn't just for Adam and Eve or all those people who lived long ago. It is for us, too. It is for all who turn away from their sins and trust in Jesus as their Savior. He came to give us special closeness with God. He came so we could know the Perfect Wonderfulness of life with God. Thank You, Jesus!

Detective Dan's Lesson 2 Listening Assignment:
Our Bible Verse is Isaiah 53:5-6

"But he was pierced for our transgressions, he was crushed for our iniquities; the punishment that brought us peace was upon him, and by his wounds we are healed. We all, like sheep, have gone astray, each of us has turned to his own way; and the LORD has laid on him the iniquity of us all!"

I need to find out:

Transgressions and iniquities are other words for sin.

1. Whose transgressions and iniquities deserved God's punishment in our story? All people.

2. Who came to take God's punishment for them?

Jesus, God's Son.

For You and Me:

The promise of the Savior wasn't just for Adam and Eve or all those people who lived long ago. It is for us, too. It is for all who turn away from their sins and trust in Jesus as their Savior. He came to give us special closeness with God. He came so we could know the Perfect Wonderfulness of life with God. He did this by paying for our sins, Himself! Thank You, Jesus!

Detective Dan's Lesson 3 Listening Assignment:

Our six clues were: a tree; a lamp; a garden; a cave grave; a bed; and, a man named Abraham.

1. Which four belong in our story?

The tree, the garden, the cave grave, and Abraham.

2. Which one did the Savior use to prove He had won? What do we thank Him for beating?

The cave grave. On the third day Jesus rose from the dead, showing that He had beat sin and death for all who turn away from their sins and trust in Him as their Savior.

For You and Me:

The promise of the Savior wasn't just for Adam and Eve or all those people who lived long ago. It is for us, too. It is for all who turn away from their sins and trust in Jesus as their Savior. He beat sin and death for us. He came to give us special closeness with God. He came so we could know the Perfect Wonderfulness of life with God. Thank You, Jesus!

The Gospel (story wrap-up if NOT using Listening Assignments)**Our Bible Truth is:****What Is the Gospel?**

It's Salvation through Faith in Jesus Christ!

God sent Jesus to pay for the sins of God's people!

How merciful is God! How great is His love for sinners, like you and me! Though we have all chosen to disobey Him, He always planned to provide us with a Savior! And that Savior would be His own, dear Son! He choose to suffer and die on the cross and give up His perfect life and the full payment for sin that we needed. How can He be our Savior? By turning away from our sins and trusting in Him as our Savior. Ask Him to help you! He loves to answer this prayer!

Close in prayer.

Closing ACTS Prayer

- A** God, we praise You for being the good Creator and King of the world.
- C** God, we confess rebelling against You and Your good ways. Too many times we choose to live life our own way instead of Yours. We need a Savior!
- T** Thank You for being our good Creator and King. Thank You for making everything in the world for Your good purposes. Thank You for being so merciful to us! Thank You for offering us salvation through Jesus, when we repent of our sins and trust Jesus as our Savior.
- S** God, work in our hearts, helping us to turn away from disobeying You. Help us to trust in Jesus as our Savior. Help us to joyfully obey You, as is best for us and brings You glory.

In Jesus' name we pray. Amen.

Questions to aid discussion of the key concepts and for use in games

Be familiar with these questions and answers. Look for opportunities to ask questions and discuss their answers, such as while the children work on their coloring pages, as part of their response games, or during play time. Remember: your goal isn't to ask all these questions or only talk to the children about these things. It is to be deliberate in having good conversations with them, however much or little you have.

<p>BIG QUESTION</p> <p>Meaning</p> <p>Discussion Questions</p>	<p>What is the Gospel? It's Salvation through Faith in Jesus Christ!</p> <p>Gospel means "good news." In the Bible, the gospel is the good news that God sent His Son Jesus to save sinners like you and me from the punishment we deserve for our sins. That salvation is ours when we turn from our sins and trust in Jesus as our own Savior.</p> <p><i>choose a few</i></p> <ol style="list-style-type: none"> 1. What is the gospel? <i>It's salvation through faith in Jesus!</i> 2. What does the word "gospel" mean? <i>It means "good news."</i> 3. Why is the gospel such good news? <i>It tells us how can forgive our sins and make us His people forever!</i> 4. Who do we need to have faith in? <i>Jesus.</i> 5. What did Jesus do so we can be saved? <i>He took the punishment for sin when He died on the cross.</i> 6. What does God want us to turn away from? <i>Our sins.</i> 7. What does it mean to turn away from our sins? <i>To say "no" to disobeying God and to want to obey Him, instead.</i> 8. Who can we ask to help us turn away from our sins and trust in Jesus? <i>God! He loves to help us when we ask Him.</i>
<p>BIBLE TRUTH</p> <p>Meaning</p>	<p>It's Salvation through Faith in Jesus Christ...God Sent Jesus to Pay for the Sins of God's People!</p> <p>What a mess we have made in God's good world! God is our good Maker and King, yet we have all chosen to disobey Him. Because God is good, He hates sin and He is right to punish our sins. We certainly deserve it! The punishment for sins is death--being separated from God and all His goodness forever. How sad!</p> <p>But God is not only good. He is also very merciful. He treats us better than we deserve. That's why God, Himself, made a way for us to be forgiven our sins and to become His people. God sent His own, dear Son, Jesus to live the perfect life of love and obedience that we should live, but never do. On the cross, Jesus offered His perfect life to God as the full payment for sin for all who turn away from their sins and trust in Him as their Savior. Jesus suffered and died in our place. Then on the third day, Jesus rose up from the dead, showing that He had really beaten sin and death! Jesus can be our Savior, too, when we turn away from our sins and trust in Him as our Savior.</p>
<p>Discussion Questions</p>	<p><i>choose a few</i></p> <ol style="list-style-type: none"> 1. Who is our good Maker and King? <i>God is.</i> 2. Who has chosen to disobey God? <i>We all have.</i> 3. What does God hate, because He is good? <i>He hates sin.</i> 4. What is God right to do to with our sin, because He hates it (and it is bad)? <i>He is right to punish our sin.</i> 5. What is God's punishment for sins? <i>It is death--being separated from God and all His goodness forever.</i> 6. Who did God send because He is not just good, but merciful, too? <i>The Savior, Jesus.</i> 7. What did Jesus do on the cross to save us? <i>He gave His perfect life as the full payment for sin.</i> 8. How can Jesus be our Savior? <i>When we turn away from our sins and trust in Him as our Savior.</i>

Questions to aid discussion of the key concepts and for use in games

<p>THE GOSPEL</p>	<p>What is God’s good news for you and me? <i>The gospel!</i> God made all people—including you and me! And He made us to know Him, love Him and obey Him. He’s our good king. But sadly, we have all disobeyed Him and we deserve His punishment. How sad! But God is so merciful that He sent a Savior. His Son, Jesus! Jesus suffered and died on the cross. He offered up His perfect life to God to completely pay for the sins of God’s people. That includes us, when we turn away from our sins and trust in Jesus as our Savior. He loves to helps us do this. Ask Him! How good is God to us!</p>
<p>BIBLE TRUTH BIBLE VERSE</p> <p>Meaning</p> <p>Discussion Questions</p> <p><i>choose a few</i></p>	<p>“But he was pierced for our transgressions, he was crushed for our iniquities; the punishment that brought us peace was upon him, and by his wounds we are healed. We all, like sheep, have gone astray, each of us has turned to his own way; and the LORD has laid on him the iniquity of us all.”--Isaiah 53:5-6</p> <p>Learn a Little: “The punishment that brought us peace was upon him.”</p> <p>God is our good King and Creator and we should love and obey Him. But the sad news is that we all choose to disobey Him...and we all deserve His punishment. Yes, we deserve His punishment, but God has loved us so much that He sent His Son, Jesus to take the punishment that we deserve instead. Jesus lived a perfect life and chose to give it up to pay for our sins. On the cross He suffered and died. He was pierced with nails in His hands and feet. He was pierced in His side with a sword. He took all of the punishment that we deserve from God for our sins so that we could be forgiven. Jesus made the way for us to have peace with God by suffering in our place. Who did Jesus do this for? It is God’s free gift to all who put their trust in Jesus as their Savior and choose to live for Him. This gift can be for you, too! Ask God to help you. He loves to answer this prayer!</p> <p>1. Who has chosen to disobey God, our good King and Creator? <i>We all have.</i> 2. Who did God send to take the punishment for our sins? <i>His Son, Jesus.</i> 3. Where did Jesus take the punishment for our sins? <i>On the cross as He suffered and died.</i> 4. Who did Jesus suffer and die for? <i>For all who turn away from their sins and trust in Him as their Savior. It is God’s free gift to all who do. It can be His gift to us, too!</i></p>
<p>BIBLE STORY</p> <p>Discussion Questions</p> <p><i>choose a few</i></p>	<p>The Case of the Savior, from Start to Finish</p> <p>1. Who enjoyed perfect wonderfulness with God in the beginning? <i>Adam and Eve did.</i> 2. What did Adam and Eve do that changed everything? <i>They chose to disobey God.</i> 3. What did Adam and Eve lose when they disobeyed God? <i>They lost the perfect world they lived in. And, they lost the wonderful life they had with God.</i> 4. What did God promise to send Adam and Eve one day? <i>A Savior to save them from their sins.</i> 5. What were the hearts of Adam and Eve’s children like? <i>They disobeyed God, too.</i> 6. What did some of Adam and Eve’s children remember? <i>The promise of the Savior. They looked forward in faith to the day He would come.</i> 7. What did God use Abraham’s family to do? <i>To be the family through whom the Savior would come. He would bless the whole world through this Savior.</i> 8. Did Abraham’s family always obey God? <i>No, they didn’t. Many times they disobeyed Him.</i> 9. Who did God send at just the right time? <i>The Savior, Jesus.</i> 10. What did Jesus do with His perfect life to save us? <i>He gave it up to God as the full payment for sins as He suffered and died on the cross.</i> 11. What did Jesus do on the third day after He was dead and buried? <i>He rose from the dead, showing He had beat sin and death for all who turn from their sins and trust in Him as their Savior.</i></p>

CAN YOU GUESS BIBLE TRUTH 3:

What's the Gospel?

**It's Salvation through Faith
in Jesus Christ...**

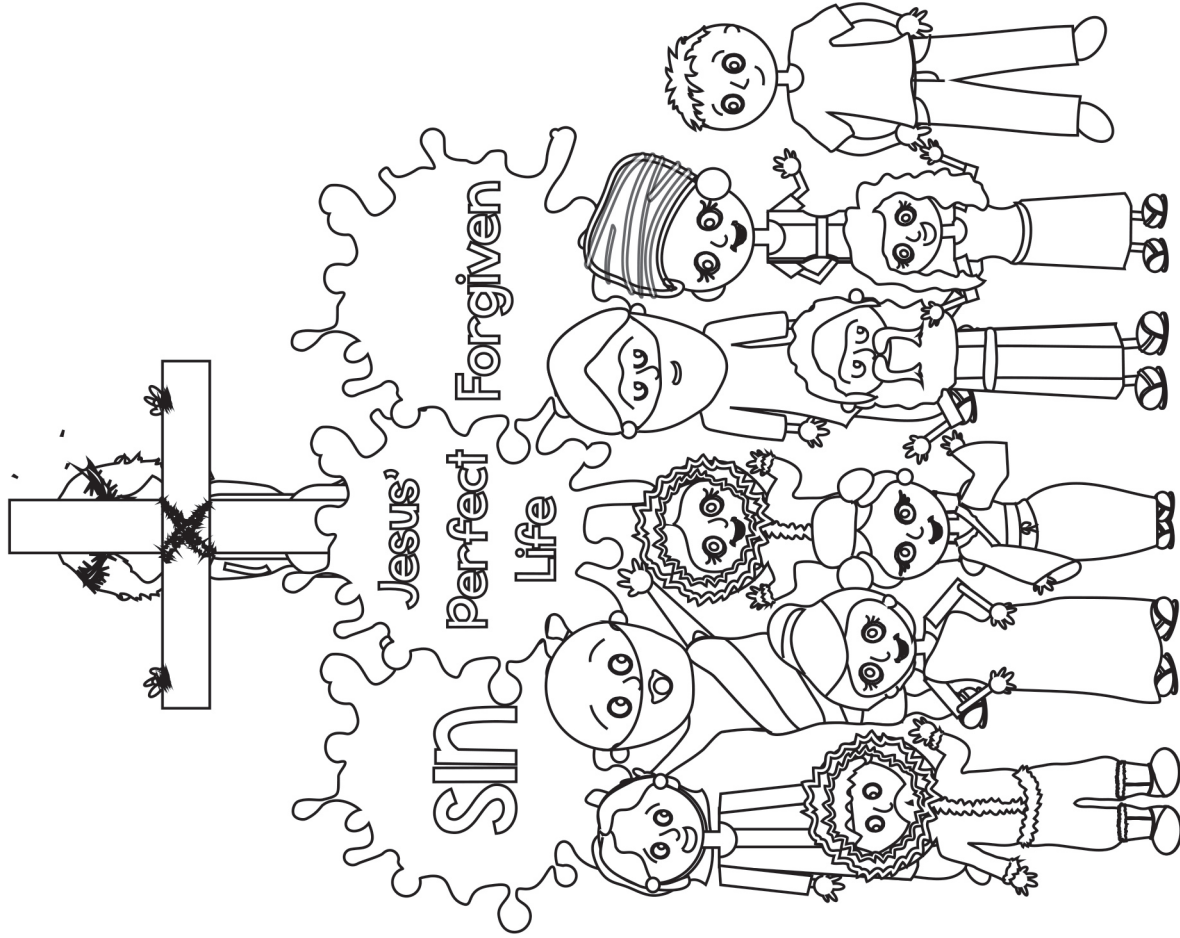

God sent ----- to pay for the sins of God's people!

HINT: What's the name of God's Son?

Deep Down Detective Devotion: Unit 3, Bible Truth 3, Lesson 1



Big Question 3 : What Is the Gospel?

Answer: It's Salvation through Faith in Jesus Christ... God sent Jesus to pay for the sins of God's people!

Bible Truth 3 Meaning

What a mess we have made in God's good world! God is our good Maker and King, yet we have all chosen to disobey Him. Because God is good, He hates sin and He is right to punish our sins. We certainly deserve it! The punishment for sins is death--being separated from God and all His goodness forever. How sad!

But God is not only good. He is also very merciful. He treats us better than we deserve. That's why God, Himself, made a way for us to be forgiven our sins and to become His people. God sent His own, dear Son, Jesus to live the perfect life of love and obedience that we should live, but never do. On the cross, Jesus offered His perfect life to God as the full payment for sin for all who turn away from their sins and trust in Him as their Savior. Jesus suffered and died in our place. Then on the third day, Jesus rose up from the dead, showing that He had really beaten sin and death! Jesus can be our Savior, too, when we turn away from our sins and trust in Him as our Savior.

How do I know this is true? The Bible tells me so!

"But he was pierced for our transgressions, he was crushed for our iniquities; the punishment that brought us peace was upon him, and by his wounds we are healed. We all, like sheep, have gone astray, each of us has turned to his own way; and the LORD has laid on him the iniquity of us all." --- Isaiah 53:5-6

Some Questions for You

1. Who is our good Maker and King? *God is.*
2. Who has chosen to disobey God? *We all have.*
3. What does God hate, because He is good? *He hates sin.*
4. What is God right to do to with our sin, because He hates it (and it is bad)? *He is right to punish our sin.*
5. What is God's punishment for sins? *It is death--being separated from God and all His goodness forever.*
6. Who did God send because He is not just good, but merciful, too? *The Savior, Jesus.*
7. What did Jesus do on the cross to save us? *He gave His perfect life as the full payment for sin.*
8. How can Jesus be our Savior? *When we turn away from our sins and trust in Him as our Savior.*

Let's Pray!

- A** God, we praise You for being the good Creator and King of the world.
- C** God, we confess rebelling against You and Your good ways. Too many times we choose to live life our own way instead of Yours. We need a Savior!
- T** Thank You for being our good Creator and King. Thank You for making everything in the world for Your good purposes. Thank You for being so merciful to us! Thank You for offering us salvation through Jesus, when we repent of our sins and trust Jesus as our Savior.
- S** God, work in our hearts, helping us to turn away from disobeying You. Help us to trust in Jesus as our Savior. Help us to joyfully obey You, as is best for us and brings You glory. In Jesus' name we pray. Amen.

Let's Sing about What We're Learning!

Big Q & A 3 Song from *Deep Down Detectives NIV Songs 3, track 12*
(sung to the tune of "Oh, My Darlin' Clementine")

What's the gospel?
What's the gospel?
Can you tell me what it is?
It's salvation through faith in Jesus,
That's what the gospel is. (repeat)

Big Question 3 Action Rhyme Song from *Deep Down Detectives NIV Songs 3, track 13*

Refrain:

What is the gospel?
G-O-S-P-E-L?
What is the gospel?
Can anybody tell me?
What is the gospel?
Yes, I know what it is!
Salvation through faith in Christ,
That's what the gospel is.

"G" is for God,
our good King and Creator,
O, we should obey Him,
but instead we're disobeyers,
So S, we need a Savior
to save us from our sins,
That Savior is Jesus,
who "P" took the punishment.

Yes, Jesus died upon the cross,
the perfect sacrifice,
Then on Day Three, He rose again
To prove He'd won the fight,

And now "E" everyone who repents
and believes in Him,
He gives "E-L" eternal life: forever life with Him. *Refrain*

Go to the *Deep Down Detectives Parent Resources for Unit 3* to get the Bible story and many more resources and songs for this unit at praisefactory.org

**“But he was pierced for our transgressions,
he was crushed for our iniquities;
the punishment that brought us peace was upon him,
and by his wounds we are healed.**

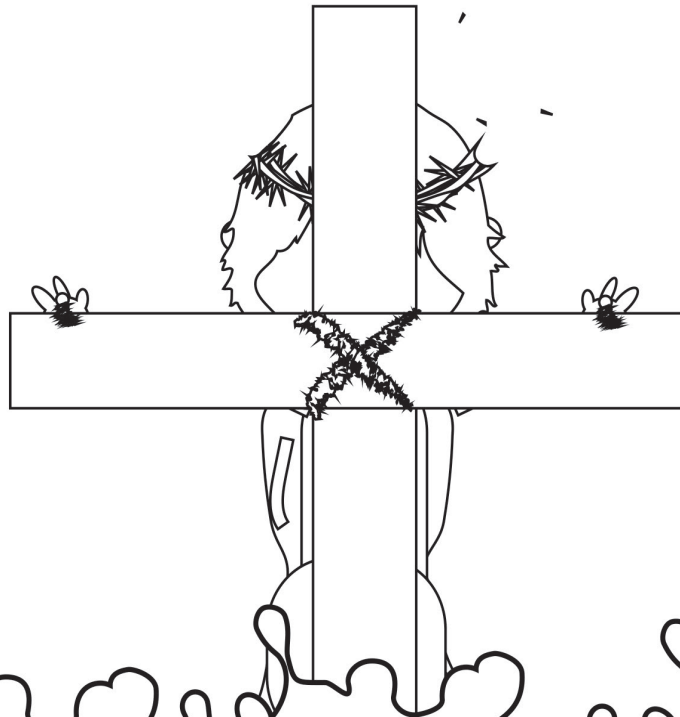

SIN Jesus' Perfect Forgiven
Life

**We all, like sheep, have gone astray,
each of us has turned to his own way;
and the LORD has laid on him the iniquity of us all.”**

Isaiah 53:5-6

Deep Down Detective Devotion: Unit 3, Bible Truth 3, Lesson 2



Big Question 3 : What Is the Gospel?

Answer: It's Salvation through Faith in Jesus Christ... God sent Jesus to pay for the sins of God's people!

How do I know this is true? The Bible tells me so!

"But he was pierced for our transgressions, he was crushed for our iniquities; the punishment that brought us peace was upon him, and by his wounds we are healed. We all, like sheep, have gone astray, each of us has turned to his own way; and the LORD has laid on him the iniquity of us all." --- Isaiah 53:5-6

Learn a Little: "The punishment that brought us peace was upon him."

Meaning

God is our good King and Creator and we should love and obey Him. But the sad news is that we all choose to disobey Him...and we all deserve His punishment.

Yes, we deserve His punishment, but God has loved us so much that He sent His Son, Jesus to take the punishment that we deserve instead. Jesus lived a perfect life and chose to give it up to pay for our sins. On the cross He suffered and died. He was pierced with nails in His hands and feet. He was pierced in His side with a sword. He took all of the punishment that we deserve from God for our sins so that we could be forgiven. Jesus made the way for us to have peace with God by suffering in our place.

Who did Jesus do this for? It is God's free gift to all who put their trust in Jesus as their Savior and choose to live for Him. This gift can be for you, too! Ask God to help you. He loves to answer this prayer!

Some Questions for You

1. Who has chosen to disobey God, our good King and Creator? *We all have.*
2. Who did God send to take the punishment for our sins? *His Son, Jesus.*
3. Where did Jesus take the punishment for our sins? *On the cross as He suffered and died.*
4. Who did Jesus suffer and die for? *For all who turn away from their sins and trust in Him as their Savior. It is God's free gift to all who do. It can be His gift to us, too!*

Let's Pray!

- A** God, we praise You for being the good Creator and King of the world.
- C** God, we confess rebelling against You and Your good ways. Too many times we choose to live life our own way instead of Yours. We need a Savior!
- T** Thank You for being our good Creator and King. Thank You for making everything in the world for Your good purposes. Thank You for being so merciful to us! Thank You for offering us salvation through Jesus, when we repent of our sins and trust Jesus as our Savior.
- S** God, work in our hearts, helping us to turn away from disobeying You. Help us to trust in Jesus as our Savior. Help us to joyfully obey You, as is best for us and brings You glory. In Jesus' name we pray. Amen.

Let's Sing Our Bible Verse!

He Was Pierced *from Deep Down Detectives NIV Songs 3, track 21*

He was pierced, He was pierced,
He was pierced for our transgressions,
He was crushed, He was crushed,
He was crushed for our iniquities.

The punishment for our peace was upon Him, upon Him,
And by His wounds, we are healed, we are healed.

He was pierced, He was pierced,
He was pierced for our transgressions,
He was crushed, He was crushed,
He was crushed for our iniquities.
Isaiah Fifty-three, verse five.

Go to the Deep Down Detectives Parent Resources for Unit 3 to get the Bible story and many more resources and songs for this unit at praisefactory.org

Which four of these clues belong in our story? Which two do not? Put an X in the boxes of the four that belong.

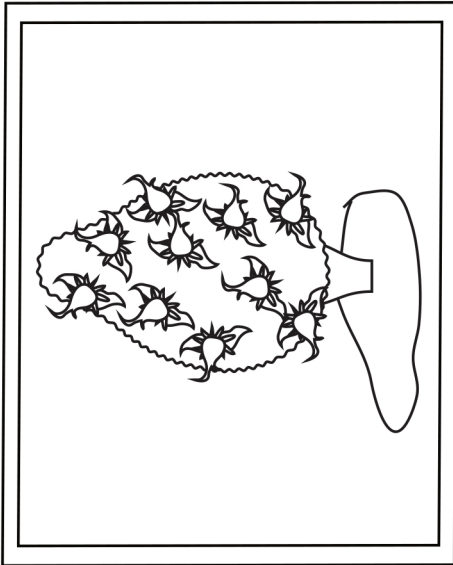

A Tree

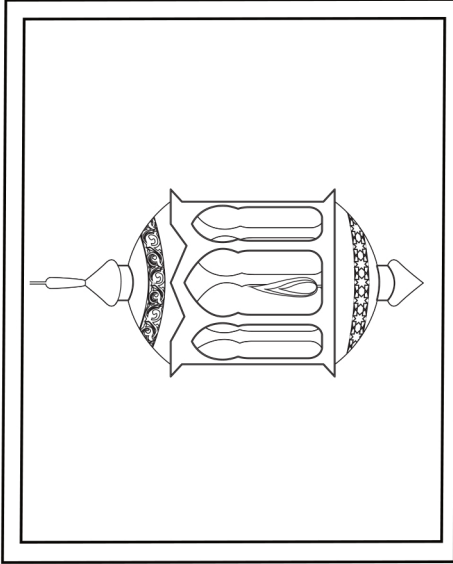

A Lamp

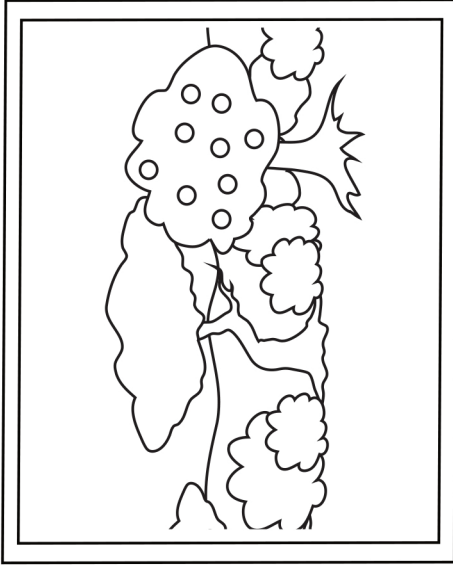

A Garden

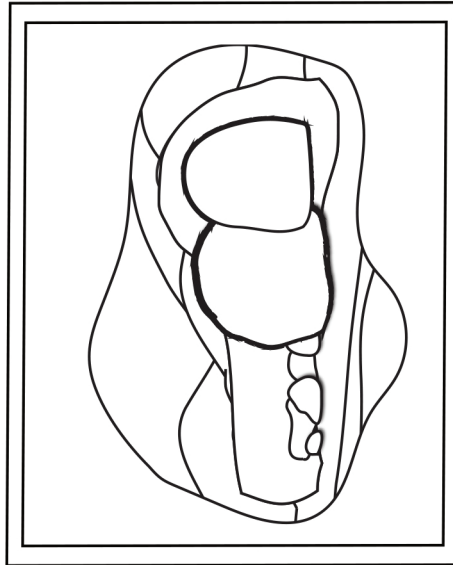

A Cave Grave

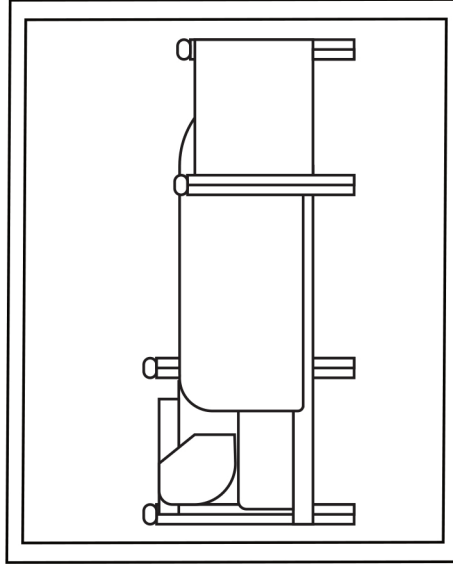

A Bed

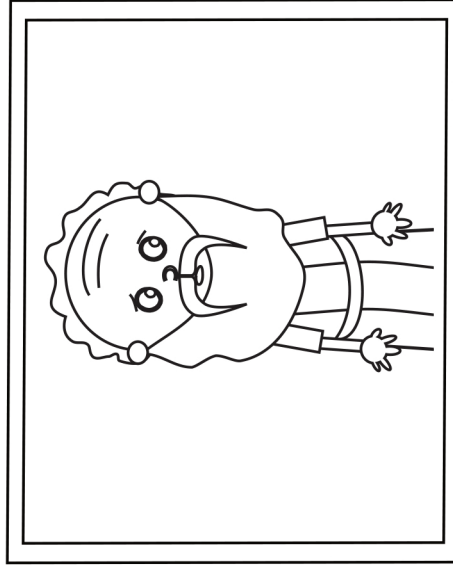

A Man Named Abraham

Answer: The tree; the garden; the cave grave; and the man named Abraham belong. The lamp and the bed do not.

Deep Down Detective Devotion: Unit 3, Bible Truth 3, Lesson 3



Big Question 3 : What Is the Gospel?

Answer: It's Salvation through Faith in Jesus Christ... God sent Jesus to pay for the sins of God's people!

Bible Truth 3 Meaning

What a mess we have made in God's good world! God is our good Maker and King, yet we have all chosen to disobey Him. Because God is good, He hates sin and He is right to punish our sins. We certainly deserve it! The punishment for sins is death--being separated from God and all His goodness forever. How sad! But God is not only good. He is also very merciful. He treats us better than we deserve. That's why God, Himself, made a way for us to be forgiven our sins and to become His people. God sent His own, dear Son, Jesus to live the perfect life of love and obedience that we should live, but never do. On the cross, Jesus offered His perfect life to God as the full payment for sin for all who turn away from their sins and trust in Him as their Savior. Jesus suffered and died in our place. Then on the third day, Jesus rose up from the dead, showing that He had really beaten sin and death! Jesus can be our Savior, too, when we turn away from our sins and trust in Him as our Savior.

How do I know this is true? The Bible tells me so!

"But he was pierced for our transgressions, he was crushed for our iniquities; the punishment that brought us peace was upon him, and by his wounds we are healed. We all, like sheep, have gone astray, each of us has turned to his own way; and the LORD has laid on him the iniquity of us all." --- Isaiah 53:5-6

Some Questions for You

Our six case clues were: a tree; a lamp; a garden; a cave grave; a bed; and, a man named Abraham.

1. Which four belong in our story?

The tree, the garden, the cave grave, and Abraham.

2. Which one did the Savior use to prove He had won? What do we thank Him for beating?

The cave grave. On the third day Jesus rose from the dead, showing that He had beat sin and death for all who turn away from their sins and trust in Him as their Savior.

3. What did Adam and Eve lose when they disobeyed God? *They lost the perfect world they lived in. And, they lost the wonderful life they had with God.*

4. What did God promise to send Adam and Eve one day? *A Savior to save them from their sins.*

5. What did God use Abraham's family to do? *To be the family through whom the Savior would come. He would bless the whole world through this Savior.*

6. Who did God send at just the right time? *The Savior, Jesus.*

7. What did Jesus do with His perfect life to save us? *He gave it up to God as the full payment for sins as He suffered and died on the cross.*

8. How can Jesus be our Savior? *When we turn away from our sins and trust in Jesus as our Savior.*

Let's Pray!

A God, we praise You for being the good Creator and King of the world.

C God, we confess rebelling against You and Your good ways. Too many times we choose to live life our own way instead of Yours. We need a Savior!

T Thank You for being our good Creator and King. Thank You for making everything in the world for Your good purposes. Thank You for being so merciful to us! Thank You for offering us salvation through Jesus, when we repent of our sins and trust Jesus as our Savior.

S God, work in our hearts, helping us to turn away from disobeying You. Help us to trust in Jesus as our Savior. Help us to joyfully obey You, as is best for us and brings You glory. In Jesus' name we pray. Amen.

Let's Praise God Right Now!

Big Q & A 3 Hymn: And Can It Be

from Deep Down Detectives NIV Songs 3, track 17

Refrain

Amazing love, how can it be?

That thou, my God, should die for me?

Amazing love, how can it be?

That thou, my God, should die for me?

Words: Charles Wesley Music: Thomas Campbell

Big Question 3 Praise Song: I Have Decided to Follow Jesus

from Deep Down Detectives NIV Songs 3, track 18

I have decided to follow Jesus,

I have decided to follow Jesus,

I have decided to follow Jesus,

No turning back, no turning back.

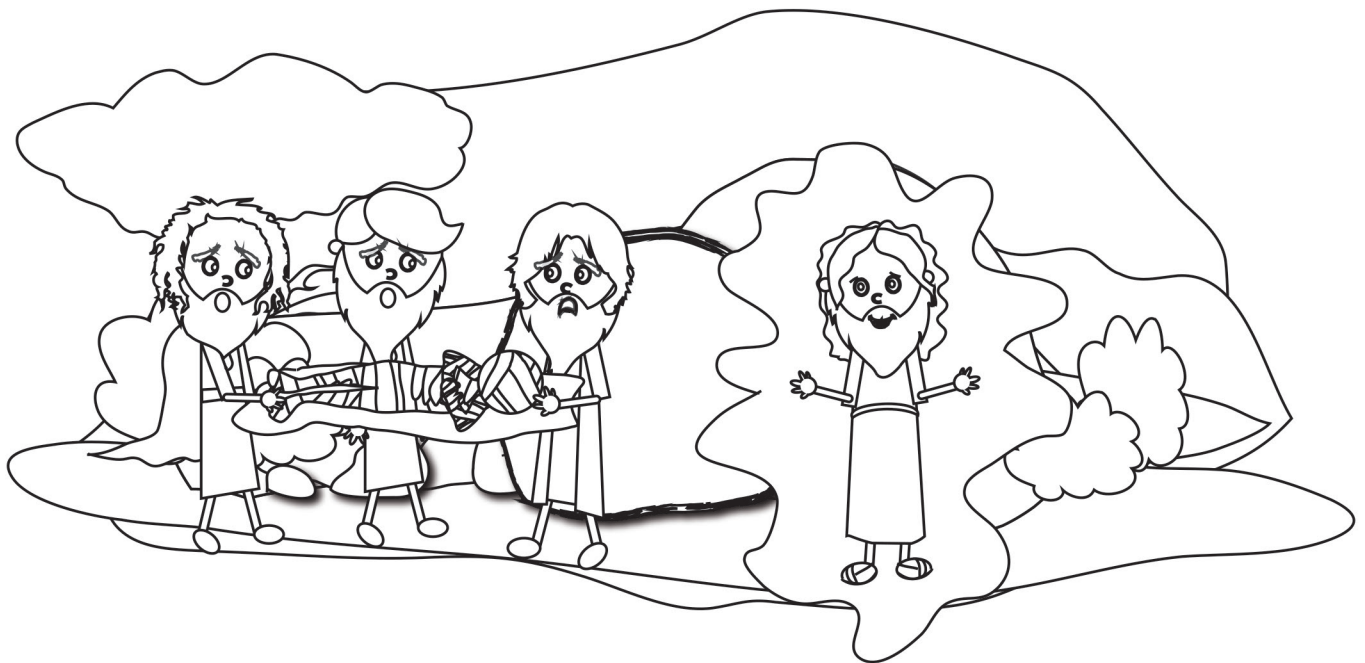
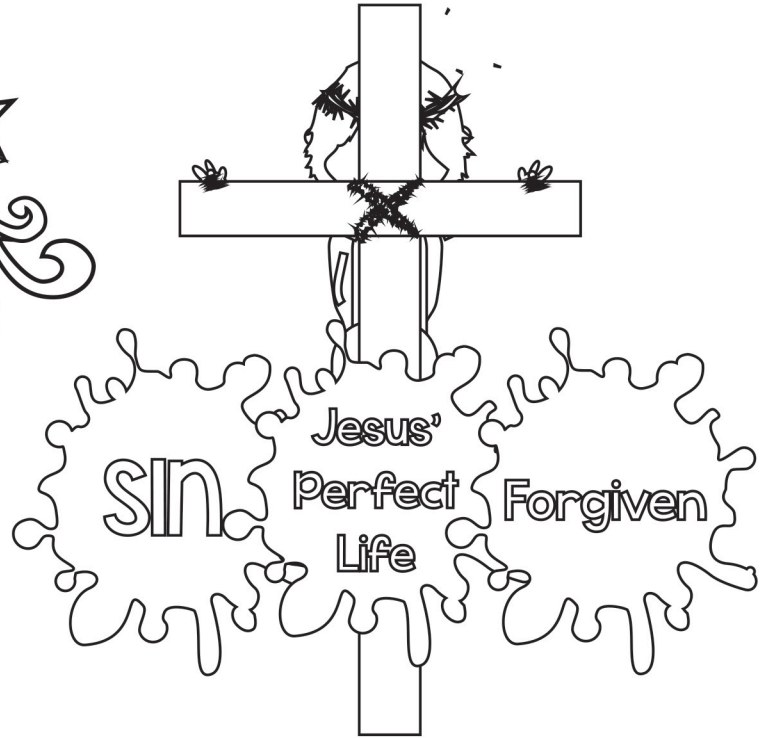

What Is the Gospel? It's Salvation through Faith in Jesus Christ...God Sent Jesus to Pay for the Sins of God's People!

How merciful is God! How great is His love for sinners, like you and me! Though we have all chosen to disobey Him, He always planned to provide us with a Savior! And that Savior would be His own, dear Son! He choose to suffer and die on the cross and give up His perfect life and the full payment for sin that we needed. How can He be our Savior? By turning away from our sins and trusting in Him as our Savior. Ask Him to help you! He loves to answer this prayer!

The Case of the Savior, from First to Last Jigsaw Puzzle Page

Genesis, The Gospels

Make copies of picture and cut out into an appropriate number of pieces for your children.
Or, you can print out color versions of this puzzle by downloading it from praisefactory.org.

What Is the Gospel? It's Salvation through Faith in Jesus Christ...God Sent Jesus to Pay for the Sins of God's People!

How merciful is God! How great is His love for sinners, like you and me! Though we have all chosen to disobey Him, He always planned to provide us with a Savior! And that Savior would be His own, dear Son! He choose to suffer and die on the cross and give up His perfect life and the full payment for sin that we needed. How can He be our Savior? By turning away from our sins and trusting in Him as our Savior. Ask Him to help you! He loves to answer this prayer!

